



**Henny Penny  
Computron 8000  
Pressure Fryers**

**OPERATOR'S MANUAL**



## **LIMITED WARRANTY FOR HENNY PENNY EQUIPMENT**

Subject to the following conditions, Henny Penny Corporation makes the following limited warranties to the original purchaser only for Henny Penny appliances and replacement parts:

**NEW EQUIPMENT:** Any part of a new appliance, except baskets, lamps, and fuses, which proves to be defective in material or workmanship within two (2) years from date of original installation, will be repaired or replaced without charge F.O.B. factory, Eaton, Ohio, or F.O.B. authorized distributor. Baskets will be repaired or replaced for ninety (90) days from date of original installation. Lamps and fuses are not covered under this Limited Warranty. To validate this warranty, the registration card for the appliance must be mailed to Henny Penny within ten (10) days after installation.

**FILTER SYSTEM:** Failure of any parts within a fryer filter system caused by the use of the non-OEM filters or other unapproved filters is not covered under this Limited Warranty.

**REPLACEMENT PARTS:** Any appliance replacement part, except lamps and fuses, which proves to be defective in material or workmanship within ninety (90) days from date of original installation will be repaired or replaced without charge F.O.B. factory, Eaton, Ohio, or F.O.B. authorized distributor.

The warranty for new equipment covers the repair or replacement of the defective part and includes labor charges and maximum mileage charges of 200 miles round trip for a period of one (1) year from the date of original installation.

The warranty for replacement parts covers only the repair or replacement of the defective part and does not include any labor charges for the removal and installation of any parts, travel, or other expenses incidental to the repair or replacement of a part.

**EXTENDED FRYPOT WARRANTY:** Henny Penny will replace any frypot that fails due to manufacturing or workmanship issues for a period of up to seven (7) years from date of manufacture. This warranty shall not cover any frypot that fails due to any misuse or abuse, such as heating of the frypot without shortening.

**0 TO 3 YEARS:** During this time, any frypot that fails due to manufacturing or workmanship issues will be replaced at no charge for parts, labor, or freight. Henny Penny will either install a new frypot at no cost or provide a new or reconditioned replacement fryer at no cost.

**3 TO 7 YEARS:** During this time, any frypot that fails due to manufacturing or workmanship issues will be replaced at no charge for the frypot only. Any freight charges and labor costs to install the new frypot as well as the cost of any other parts replaced, such as insulation, thermal sensors, high limits, fittings, and hardware, will be the responsibility of the owner.

Any claim must be presented to either Henny Penny or the distributor from whom the appliance was purchased. No allowance will be granted for repairs made by anyone else without Henny Penny's written consent. If damage occurs during shipping, notify the sender at once so that a claim may be filed.

THE ABOVE LIMITED WARRANTY SETS FORTH THE SOLE REMEDY AGAINST HENNY PENNY FOR ANY BREACH OF WARRANTY OR OTHER TERM. BUYER AGREES THAT NO OTHER REMEDY (INCLUDING CLAIMS FOR ANY INCIDENTAL OR CONSEQUENTIAL DAMAGES) SHALL BE AVAILABLE.

The above limited warranty does not apply (a) to damage resulting from accident, alteration, misuse, or abuse; (b) if the equipment's serial number is removed or defaced; or (c) for lamps and fuses. THE ABOVE LIMITED WARRANTY IS EXPRESSLY IN LIEU OF ALL OTHER WARRANTIES, EXPRESS OR IMPLIED, INCLUDING MERCHANTABILITY AND FITNESS, AND ALL OTHER WARRANTIES ARE EXCLUDED. HENNY PENNY NEITHER ASSUMES NOR AUTHORIZES ANY PERSON TO ASSUME FOR IT ANY OTHER OBLIGATION OR LIABILITY.

Revised 01/01/07.

## TABLE OF CONTENTS

Section	Page
Section 1. OPERATION.....	1-1
1-1. Introduction.....	1-1
1-2. Safety.....	1-1
1-3. Operating Controls.....	1-2
1-4. Clock Set.....	1-5
1-5. Basic Operations and Procedures.....	1-7
1-6. Clean-Out Mode.....	1-10
Section 2. PROGRAMMING.....	2-1
2-1. Introduction.....	2-1
2-2. Product Program Mode.....	2-1
2-3. Special Program Mode.....	2-8
2-4. Data Logging, Heat Control, Tech, and Stat Modes.....	2-17
2-5. Program Settings Worksheets.....	2-17
Section 3. ERROR CODES	
3-1. Introduction.....	3-1
3-2. Error Code Table.....	3-1
Section 4. INFORMATION MODE	
4-1. Information Mode Functions.....	4-1
Section 5. PARTS INFORMATION & WIRING DIAGRAMS	
5-1. Introduction.....	5-1
5-2. Genuine Parts.....	5-1
5-3. How to Order.....	5-1
5-4. Prices.....	5-1
5-5. Delivery.....	5-1
5-6. Warranty.....	5-1
5-7. Recommended Spare Parts for Distributors.....	5-1
Wiring Diagrams.....	5-4
Distributor Lists - Domestic and International	

## SECTION 1. OPERATION

### 1-1. INTRODUCTION

This section provides basic operating procedures for the Henny Penny Computron 8000 Fryer. See the Operator's Manual for the fryer for more details on fryer operation.

### 1-2. SAFETY

The only way to ensure safe operation of the Henny Penny Computron 8000 Fryer is to fully understand the proper installation, operation and maintenance procedures, found in the fryer Operator's Manual. The instructions in this manual have been prepared to aid you in learning the controls. Where information is of particular importance or is safety related, the words NOTICE, CAUTION, or WARNING are used. Their usage is described below:



**SAFETY ALERT SYMBOL** is used with DANGER, WARNING, or CAUTION which indicates a personal injury type hazard.



**NOTICE** is used to highlight especially important information.



*CAUTION used without the safety alert symbol indicates a potentially hazardous situation which, if not avoided, may result in property damage.*



*CAUTION indicates a potentially hazardous situation which, if not avoided, may result in minor or moderate injury.*











**WARNING** indicates a potentially hazardous situation which, if not avoided, could result in death or serious injury.







**DANGER INDICATES AN IMMINENTLY HAZARDOUS SITUATION WHICH, IF NOT AVOIDED, WILL RESULT IN DEATH OR SERIOUS INJURY.**

**1-3. OPERATING CONTROLS**

Refer to Figure 1-1.

<b>Fig. No.</b>	<b>Item No.</b>	<b>Description</b>	<b>Function</b>
1-1	1	 HEAT ON	Lights when the control calls for heat; the elements or burners come on and heat the shortening
1-1	2	Digital Display	Shows all the functions of the Cook Cycle, program modes, diagnostic modes, and alarms
1-1	3	 PRESSURE ON	Lights when the solenoid closes and pressure starts to build inside frypot
1-1	4		Flashes when the shortening temperature is NOT at the proper temperature for cooking product
1-1	5		Lights when the shortening temperature is 5° F (3° C) below to 15° F (9° C) above the cooking temperature, signaling the operator that the shortening temperature IS at the proper temperature for cooking product
1-1	6	 INFO	<p>Press to display the following fryer information and status:</p> <ol style="list-style-type: none"> <li>The temperature of the shortening</li> <li>The temperature setpoint</li> <li>Filter status</li> <li>The number of times filtered today</li> <li>The average no. of filters per day</li> <li>No. of times Cook Cycle was stopped early today</li> <li>No. of times Cook Cycle was stopped early in past week</li> <li>Oil Life Display (Only if “Change Oil” feature is enabled)</li> <li>Date and time</li> </ol> <p>If pressed in the Program Mode, shows previous settings;</p> <p>pressing this along with  accesses the Information Mode which has historic information on the operator and fryer’s performance</p>
1-1	7 & 8	 DOWN  UP	Used to adjust the value of the currently displayed setting in the Program modes

**1-3. OPERATING CONTROLS**  
**(Continued)**

<b>Fig. No.</b>	<b>Item No.</b>	<b>Description</b>	<b>Function</b>
1-1	9		Press to access program modes; once in the program mode, it is used to advance to the next setting; if pressed along with  it accesses the Information Mode which has historic information on the operator and fryer's performance
1-1	10		Used to start and stop Cook Cycles, and to stop the timer at the end of a Holding Cycle
1-1	11	Menu Card Window	The name of the food product associated with each product selection button; the menu card strip is located behind the decal
1-1	12	Product Select Buttons	Used to select the product for cooking; to start Cook Cycles with them; see section 2, Special Program Mode item SP-10
1-1	13	COOK/PUMP Switch	A 3-way switch with a center OFF position; turn the switch to the COOK position to operate the fryer; turn the switch to the PUMP position to operate the filter pump; certain conditions must be met before operating the filter pump; these conditions are covered later in the Filtering section of the fryer manual
1-1	14		Used to manually enter an Idle Mode, or Clean-Out Mode

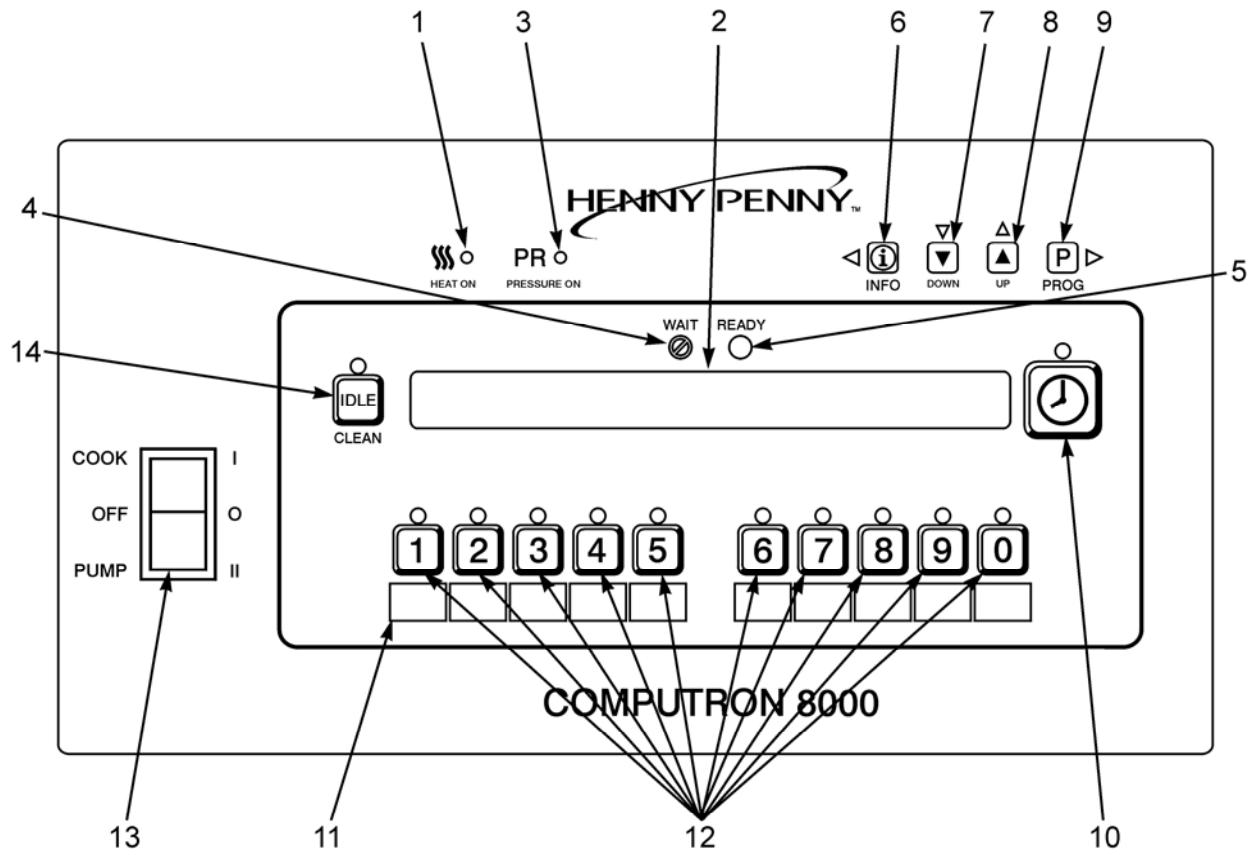



















**Figure 1-1. Control Panel**

**1-4. CLOCK SET**



**NOTICE**

Upon initial start-up, or PC board replacement, if “CLOCK SET” automatically appears in the display, start with step 4.



1. Press and hold  for 5 seconds until “LEVEL 2” shows in display.
2. Press  and “CLOCK SET”, “ENTER CODE” shows in display.
3. Press   .
4. “CS-1, SET, MONTH”, and the month flashes in the display.
5. Press the   to change the month.
6. Press  and “CS-2, SET, DATE” shows in the display, with the date flashing.
7. Press   to change the date.
8. Press  and “CS-3, SET, YEAR” shows in the display, along with the year flashing.
9. Press   to change the year.
10. Press  and “CS-4, SET, HOUR” shows in the display, with the hour and “AM” or “PM” flashing.
11. Press   to change the hour and AM/PM setting.
12. Press  and “CS-5, SET, MINUTE” shows in the display, with the minutes flashing.
13. Press   to change the minutes.

**1-4. CLOCK SET**  
**(Continued)**

14. Press  and “CS-6, CLOCK MODE” shows in the display, along with “1.AM/PM”.

“1.AM/PM” is 12 hour time, “2.24-HR” is 24 hour time. Press   to change.

15. Press  and “CS-7, DAYLIGHT SAVINGS ADJ” shows in the display, along with “2.US”.



Press   to change to the following:

- a. “1.OFF” = No automatic adjustments for Daylight Savings Time.
- b. “2.US” = Automatically applies United States Daylight Savings Time adjustment. DST activated on the first Sunday in April. DST de-activated on the last Sunday in October.
- c. “3.EURO” = Automatically applies European (CE) Daylight Saving Time adjustment. DST activated on the last Sunday in March. DST deactivated on the last Sunday in October.

16. Press  and “CS-8, BEGIN NEW DAY” shows in display, along with “3:00AM”.

This setting indicates the time of day that statistics start accumulating for a new day. If set to 3:00AM, for example, then late night Cook Cycles and filter operations from midnight to 3:00AM Tuesday morning, are accumulated with Monday's statistics.

The CS-8 value can be set from 12:00AM (midnight) to 8:00AM, in half hour increments (12:00 AM, 12:30 AM, 1:00 AM, 1:30 AM, etc.). The default value for general market software is 3:00 AM.

Press   to change the time the new day starts.

17. Clock Set is now complete. Press and hold  to exit.

**1-5. BASIC OPERATIONS AND PROCEDURES**

These are just basic procedures. Refer to the fryer Operator's Manual for more detailed instructions.

1. Be sure the drain valve is in the closed position.
2. Remove fry basket from frypot and leave lid up.
3. Fill the frypot with shortening.

**CAUTION**

*When using new shortening, it is recommended to melt the shortening on an outside source before placing shortening in the frypot. Unless elements are completely covered in shortening, fire or damage to the frypot could result.*

4. Move power switch to the COOK position. Unit automatically goes into the Melt Cycle. When the temperature reaches 230°F (110°C) the control goes into the Heat Cycle, and heats the shortening until the temperature setting is reached.



**NOTICE**

Bypass the Melt Cycle, if desired, by pressing a product button and holding it for five seconds. The display shows "EXIT MELT? 1=YES 2=NO". Press  to exit melt.

If the melt cycle is bypassed on fryers with the Frypot Protection System (FPS), the unit continues to heat as controlled by the FPS. No change in heat-up time will be observed.

**CAUTION**

*Do not bypass the Melt Cycle unless enough shortening has melted to completely cover all of the heating elements, or the curved surface of the gas frypot. If Melt Cycle is bypassed before these surfaces are covered, excessive smoking of the shortening or a fire will result.*

5. Once out of the Melt Cycle,  flashes until 5°F (3°C) before setpoint temperature is reached. Then  illuminates and the selected product shows in the display.

**1-5. BASIC OPERATIONS  
AND PROCEDURES  
(Continued)**

6. Completely stir shortening to stabilize the temperature throughout the frypot.
7. Once the shortening temperature has stabilized at the setpoint temperature, place the baskets into the shortening. Then place product into the basket.



**Do not overload, or place product with extreme moisture content into the basket. 18 lbs. (8.2 kgs) for the 561 and 12 lbs. (5.4 kgs) for the 500 and 600, is the maximum amount of product per frypot. Failure to follow these directions can result in shortening overflowing the frypot. Serious burns or damage to the frypot could result.**



8. Lift the basket slightly out of the shortening and shake basket to separate pieces.
9. Remove basket handle and close lid quickly, latching the lid.
10. Tighten the lid spindle clockwise, sealing the lid. Align red knob on the spindle with red knob on the latch.



**LATCH THE LID PROPERLY AND ALIGN THE RED BALLS OR SEVERE BURNS WILL RESULT.**

11. Press  to start a Cook Cycle. The display counts down the cooking time.



A different product can be selected during the first minute of cooking, in case the wrong product button was pressed. To check the shortening temperature press  or to stop a Cook Cycle, press .

INFO

**1-5. BASIC OPERATIONS  
AND PROCEDURES  
(Continued)**

12. Within a few minutes, the pressure gauge increases to the OPERATING ZONE. If not, recheck the installation and operation procedures in Operator's Manual.
13. Near the end of the Cook Cycle the fryer automatically depressurizes, an alarm sounds and the display flashes "DONE". To stop the alarm, press.



**DO NOT ATTEMPT TO OPEN LID UNTIL THE PRESSURE DROPS TO ZERO. LID IS LOCKED WHEN FRYER IS UNDER PRESSURE. DO NOT ATTEMPT TO FORCE THE LID LATCH OR OPEN THE LID WHILE UNDER PRESSURE. OPENING THE LID WHEN THE FRYPOT IS PRESSURIZED ALLOWS HOT SHORTENING AND STEAM TO ESCAPE FROM THE FRYPOT, RESULTING IN SEVERE BURNS.**

14. After pressure drops to zero, turn the spindle counter-clockwise.

**CAUTION**

*Do not flip or spin the spindle cross arm when opening the lid because it could damage the acme nut inside the cross bar.*

15. Unlatch and raise the lid quickly to allow most of the condensation on the lid to drain through the drain channel and not into the shortening.

**CAUTION**

*Do not let the lid slam up against the backstop because damage to the hinge could result.*

16. Using the detachable handle, lift the basket and inspect product for doneness. Dump product into holding pan.
17. If a Quality time (hold time) was programmed, the controller automatically starts the hold timer. The display alternately shows the product selected and the quality time remaining in minutes. If a different product is selected during the Hold Cycle, the display only shows the product selected.

**1-5. BASIC OPERATIONS  
AND PROCEDURES  
(Continued)**

18. At the end of the Hold Mode, a tone sounds, the display flashes “QUALITY”, and the product it was timing. Press and release  .

**NOTICE**

In the Cook Mode, when “FILTER SUGGESTED”, shows in the display, the operator has the option to filter at this time, or to continue cooking. But, if the operator continues cooking, a Filter Lockout occurs within the next Cook Cycle, or two.

The shortening continues to heat when filter lockout occurs. If the shortening temperature is below the preset temperature in the Special Program Mode (SP-8C or SP-8D), a tone sounds and “FILTER LOCKOUT”, and then “WAIT” shows on the display. Once the shortening temperature reaches the preset temperature, "FILTER LOCKOUT" , and then "YOU \*MUST\* FILTER NOW.....” shows in the display and the shortening can now be filtered. During filter lockout,





is the only button that functions, until the unit is filtered. Follow the steps in the 500/561/600 Operator’s Manual on filtering.



**1-6. CLEAN-OUT MODE**

The Computron 8000 has a Clean-Out Mode to clean the frypot upon initial start-up and every change of shortening.

Follow the steps in the 500/561/600 Operator’s Manual on Cleaning the Frypot.

When heating the cleaning solution and vinegar solutions, turn the COOK/PUMP switch to COOK. When the fryer starts the Melt Cycle, press and hold  then

“CLEAN-OUT ?”, “1=YES 2=NO” shows in display. Press  to start Clean-Out Mode. The fryer displays

“\*CLEAN-OUT MODE\*” and heats up to a preprogrammed temperature, up to 195°F (91°C), then automatically begins a preset timed countdown. Use the   buttons, if

necessary, to adjust the temperature and keep the cleaning solution from boiling over. See Special Program Modes SP-10 and SP-11 to preset the temperature and time.

**1-6. CLEAN-OUT MODE**  
**(Continued)**



**NEVER PRESSURIZE FRYER TO CLEAN. LEAVE THE LID OPEN. WATER UNDER PRESSURE IS SUPER HEATED AND CAUSES SEVERE BURNS IF IT COMES IN CONTACT WITH SKIN.**



**If the cleaning solution in the frypot starts to foam and boil over, immediately turn the Cook/Pump Switch to OFF and do not try to contain it by closing the fryer lid or severe burns could result.**



## SECTION 2. PROGRAMMING

### 2-1. INTRODUCTION

The controls are preset from the factory, but desired functions can be programmed in the field. This section includes the Product Programming Mode, which are the basic settings, and the Level 2 programming, which are the more detailed settings.

### 2-2. PRODUCT PROGRAM MODE

This mode allows the operator to change and set various parameters for each product.

#### **To Change Times and Temperatures**

1. Press and hold  for one second until  

PROG

 “PROG” shows in the display, followed by “ENTER CODE”.
2. Enter code 1, 2, 3. “SELECT PRODUCT...PRESS PROG” scrolls across the display.
3. Press and release the desired product button (1 to 10).

### NOTICE







Press  to copy a product, erase a product, preset a product, erase all products, or preset all products.

4. Press and release . The name of that product  

PROG

 shows in the display. Ex., “NAME FRIES”.

















#### **Change Product Names**

- a. Press and release   and the first letter, or digit, starts flashing.
- b. Press and release   to change the flashing letter.
- c. To continue to the next letter, press . Then press   to change this letter.
- d. Repeat step c until up to 7 letters are entered.

**2-2. PRODUCT PROGRAM  
MODE (Continued)**

e. Press and hold  to exit Program Mode, or press

and release  until “PRELOAD” shows in display, to continue with Program Mode.



5. The Preload Mode allows the operator to drop large pieces first, with the lid up, before loading the rest of the product. The Preload Cycle always runs without pressure and which always regulates to the Step 1 cook temperature. Press   to set a preload time, or press  if no preload is desired.
6. Press and release  and "1. COOK TIME" shows in the display along with the preset time. Press   to change the time. The time shows in minutes and seconds. Press and hold the buttons, and the time will jump by 5-second increments to a maximum of 59:59.
7. Press and release  and "1. TEMP" shows in the display, along with the preset temperature on the right side of the display. Press   to change the temperature. Press and hold the buttons and the temperature will jump by 5-degree increments to a max. of 380°F (193°C), and a min. of 190°F (88°C).
8. Press and release  and “1. PRESSURE” shows in the display along with “YES” or “NO”. Press   to build pressure in the first step, or not.
9. Press and release  and “2. STEP 2 AT” shows in display, along with a step 2 time. If no step 2 is desired, set time to “0:00” and press . If a step 2 is desired, press   and set a time. Then press  to set temperature and pressure.

**2-2. PRODUCT PROGRAM  
MODE (Continued)**

**NOTICE**

Up to 10 steps can be programmed for a product, repeating the above step for each cooking step.

10. Press and release  and “ALARM – 1 AT 0:00”

shows in the display. Press and release  

to set an alarm. Ex., If a Cook Cycle was set at 3 minutes, and an alarm was to go off after 30 seconds into the Cook Cycle, “2:30” would be set in the display at this time. When the timer counts down to 2:30 the alarm sounds.

After the alarm time is set, press  and “ALARM” and “TYPE” flashes in the display, with the alarm type on the right side of the display. “TIME”, “SHAKE”, “STIR”, “ADD”, and “LID” can be set by pressing





. An alarm sounds and alarm type flashes,



prompting the operator to shake the basket, stir the product, or add product. If “TIME” is selected, the time remaining flashes in the display. If “LID” is selected, “CLOSE LID” flashes in the display. The timer count-down is paused until the lid is closed and  is pressed to restart the timer.

**NOTICE**

Up to four alarms can be programmed. After the first one is set, the other alarms can be accessed by pressing

 again.

11. Press and release  until “QUALITY TMR” shows



in the display along with the preset holding time. Press and release the   to adjust the holding time, up to 59:59.



**NOTICE**

To exit the Program Mode at any time, press and hold



 for 2 seconds.

**2-2. PRODUCT PROGRAM  
MODE (Continued)**

12. Press and release  and "LOAD COMP" shows in the display along with the load compensation value. This automatically adjusts the time to account for the size and temperature of the cooking load. Press and release   to change this value to a max. of 20 and a min. of 0. Preset at factory to 5.

13. Press and release  and "LCOMP REF" shows in the display (if load compensation is set to "OFF", then "\_\_\_" shows in display) along with the load compensation average temperature. This is your average cooking temperature for the products you cook. The timer speeds up at temperature above this setting and slows down at temperatures below this setting. Press and release   to change this value.



Or, to use the cooking setpoint temperature as the load compensation reference point, press  until "STEP-X" and "TEMP" flashes in the display. Now for example, if the cooking temperature is 350°, the timer speeds up when the shortening temperature is above 350, and slows down when the temperature is below 350.

14. **Go to Idle after Done?**  
Press and release  and "GO TO IDLE, AFTER DONE" shows in the display, along with "YES" or "NO". Press   to toggle between YES and NO.

15. **Filter Cycle Mode (Optional)**  
For "FILTER AFTER" to appear in the Product Program Mode, the Filter Tracking must be enabled in the Special Program Mode. (See paragraph 2-3.) You have the option to program "mixed" (each product has its own filter count) or "global" (all products have the same count).  
Press .



**2-2. PRODUCT PROGRAM**  
**MODE (Continued)**

**“2,Mixed”**

- a. "FILTER AFTER" shows in the display, along with the preset number of Cook Cycles.
- b. Press and release   until the desired number of

Cook Cycles between filters shows in the display. For example, if 4 is set for a product, each time that product is selected, it counts 1/4, or 25%. Then, each time a product is cooked, the percentages add up until 100%, or more is reached. Then, display shows "FILTER SUGGESTED".



**"3,GLOBAL"**

- a. "FILTER INCL" shows in the display, along with "NO" or "YES".
- b. Press and release   to "YES" if that product is

to be included in the filter count, or "NO" if it is not.

**Copy/Erase Preset Products**

Products and their setpoints can be copied from one menu location on the controller to another location, preset the controls to factory settings, or erase products and all their values.

1. Press and hold  for one second until "PROG" shows in the display, followed by "ENTER CODE".
2. Enter code 1, 2, 3. "SELECT PRODUCT...PRESS PROG" scrolls across the display, followed by "DOWN FOR OPTIONS".
3. Press  and "\*\*\*OPTION\*\*", followed by

"\*1. COPY A PROD" shows in display. Press again, each time, to view the following options:



- \*1. COPY A PROD
- \*2. ERASE A PROD
- \*3. PRESET A PROD
- \*4. ERASE ALL
- \*5. PRESET ALL

**2-2. PRODUCT PROGRAM  
MODE (Continued)**

4. To select one of the above options, press  while the desired option shows in display.

Selecting PRESET A PROD, or PRESET ALL PROD sets factory setpoints in those menu items.

**NOTICE**

Press  at any time to exit the Options menu, or wait 30 seconds and controller automatically exits.

The following are examples of copying and erasing products:

Copying

Press  to select the presently displayed "COPY A PROD" option. "COPY \_\_ TO \_\_" shows in display.

The first set of "\_" is blinking. Select the product you wish to copy *from*, for example, by pressing the  button:

"COPY 2 TO \_\_" shows in display.

Next, press product you want to copy to, for example, by pressing the  button. The controller responds with a confirmation message:

"COPY 2 TO 0?"  
"1=YES 2=NO"

Press  (YES) and the controller copies product #2 to the product #0 position (the #2 product is left intact) and the display shows "\* COPIED \*", then returns to the "Select Prog Product" step with the #0 product already selected.

Press  (NO), or don't press any button for 20 seconds, the controller displays "X CANCELED X" and exits the copy process. In this case, no changes are made.

Erasing

On the "Select Prog Product" step, press  :

"\*\* OPTIONS \*\*" followed by "\*1. COPY A PROD" shows in display.

**2-2. PRODUCT PROGRAM**  
**MODE (Continued)**

Press  three more times to reach the "Erase All" option:

“\*2. ERASE A PROD”

“\*3. PRESET A PROD”

“\*4. ERASE ALL”

Press  to select the presently displayed "Erase All" option. The controller responds with a confirmation message:

“ERASE ALL PROD ?”

“1=YES 2=NO”

Press  (YES) to confirm that you want to erase all

products back to "empty" values. The controller responds by erasing each product individually...

“ERASING 1”

“ERASING 2”

“ERASING 3”

“ERASING 4”

“ERASING 5”

“ERASING 6”

“ERASING 7”

“ERASING 8”

“ERASING 9”

“ERASING 0”

Then briefly displays “\* ALL ERASED \*” and finally, returns to the "Select Prog Product" display.

**2-3. SPECIAL PROGRAM MODE**

The Special Program Mode is used to set more detailed parameters listed below.

- SP-1** • Degrees Fahrenheit or Celsius
- SP-2** • Language: English, French, German, Spanish, and Portuguese
- SP-3** • System Initialization
- SP-4** • Audio volume
- SP-5** • Audio tone
- SP-6** • Type of shortening to be melted - liquid, solid
- SP-7** • Idle Mode
- SP-8** • Filter tracking
- SP-9** • Product buttons
- SP-10** • Clean-out minutes
- SP-11** • Clean-out temperature
- SP-12** • Nominal amps reading
- SP-13** • Amps reading low limit (percentage)
- SP-14** • Amps reading high limit (percentage)
- SP-15** • Program code change
- SP-16** • Usage code change
- SP-17** • Change shortening - A-Cook Cycles
- SP-18** • Change shortening - B-Hours

1. Press and hold  for 5 seconds until "L-2" and "LEVEL 2", followed by, "SP PROG" and "ENTER CODE" shows in the display.
2. Enter code 1, 2, 3, and "SP-1 ", "TEMP, UNITS" shows in the display.



**NOTICE**

If a bad code is entered, an alarm sounds and "BAD CODE" shows on the display. Wait a few seconds, the control reverts back to the Cook Mode, and repeat the above steps.

To exit from the Special Program Mode at any time, press and hold  button for 2 seconds, or to roll back to

previous setting, press .

**Degrees Fahrenheit or Celsius (SP-1)**

- a. Follow steps 1 and 2 above.
- b. The display flashes "SP-1" and "TEMP, UNITS", along with "°F" or "°C". Press  to toggle from "°F" to "°C", or vice versa. 

**2-3. SPECIAL PROGRAM  
MODE (Continued)**

**Language (SP-2)**



- a. Follow steps 1 and 2 above.
- b. Press and release  button. "SP-2" and "LANGUAGE" flash on the display, along with the language (Ex., "1.ENGL").
- c. To toggle to the desired language, press and release



**System Initialization (SP-3)**



This step resets the controls, but doesn't erase product settings.

- a. Follow steps 1 and 2 above.
- b. Press and release  twice. "SP-3" and "DO SYSTEM INIT" flashes on the display, along with "INIT".

- c. Press and hold . "INIT" shows on the display, a tone sounds, and "IN 3", "IN 2", "IN 1" flashes on the right side of the display. When "INIT" starts flashing on the left side of the display, release . When "DONE" shows on the display, the initialization is complete, and the controls now have factory preset parameters.

**Audio Volume (SP-4)**



The volume of the speaker can be adjusted.

- a. Follow steps 1 and 2 above.
- b. Press the  3 times. "SP-4" and "AUDIO VOLUME" flash on the display, along with the volume value.
- c. Press   to adjust the speaker volume; 10 the maximum value and 1 the minimum.

**2-3. SPECIAL PROGRAM  
MODE (Continued)**

**Audio Tone (SP-5)**

The tone of the speaker can be adjusted.



- a. Follow steps 1 and 2 above.
- b. Press  4 times. "SP-5" and "AUDIO TONE (HZ)" flashes on the display, along with the tone value.
- c. Press   to adjust the tone of the speaker; 2000 the maximum, 50 the minimum.

**Type of shortening to be melted - Liquid or Solid (SP-6)**

The Melt Cycle can be set to the type of shortening being used.

**NOTICE**

If the fryer has the FPS, it accounts for the type of shortening automatically, and does not need set unless the system becomes disabled.

- a. Follow steps 1 and 2 above.
- b. Press and release  5 times. "SP-6" and "MELT CYCLE SELECT" flashes on the display, along with "1=LIQ" or "2=SOLID".
- c. Press   to toggle from one type to another.

**CAUTION**













*The type of shortening being used in the fryer determines the amount of heat applied during the Melt Cycle. If the controls are set to the Solid setting, less heat is applied to the shortening, than if the controls were set to Liquid. Too much heat applied to solid shortening causes much smoking, and could cause a fire. Match this setting to the type of shortening being used at the time.*

*When using new shortening, it is recommended to melt the shortening on an outside source before placing shortening in the frypot. Unless elements are completely covered in shortening, fire or damage to the frypot could result.*

**2-3. SPECIAL PROGRAM  
MODE (Continued)**

**Idle Mode (SP-7)**

A programmed Idle Mode allows the shortening temperature to drop to a lower temperature when not in use. This saves on the shortening and utilities.



- a. Follow steps 1 and 2 above.
- b. Press and release  6 times. "SP-7" and "IDLE MODE ENABLED?" flashes in the display, along with "NO" or "YES".
- c. Press and release   to toggle from NO to YES, or vice versa.
- d. With "YES" in the display, the Idle Mode is enabled.  
Press and release . "SP-7A" and "IDLE SETPT TEMP" shows in the display, along with the preset temperature.
- e. Change idle setpoint temperature, by pressing  .
- f. Press and release . "SP-7B" and "AUTO-IDLE MINUTES" shows in the display, along with the preset time.
- g. Press   to set the minutes the fryer stays idle before the Auto-idle is enabled; 60 the maximum, OFF the minimum. Ex., "30" in the display means, if product is not cooked in that frypot for 30 minutes, the control automatically activates the idle setpoint temperature, programmed above.
- h. Press and release . "SP-7C" and "GO IDLE AT MELT ?" shows in display.
- i. Press   to toggle from NO to YES, or vice versa. With "YES" in the display, the fryer automatically enters the Idle Mode once the Melt Mode is exited.

**2-3. SPECIAL PROGRAM  
MODE (Continued)**

**Filter Tracking Enabled (SP-8)**

The controls can be set to signal the operator when the shortening needs filtering. The Filter Tracking must be enabled to program the number of Cook Cycles between filtering procedures. (See Filter Cycles, paragraph 2-2.)



- a. Follow steps 1 and 2 above.
- b. Press and release  until "SP-8" and "FILTER TRACKING ENABLED" flashes on the display, along with "1,OFF".



- c. To enable the filter tracking, press   to toggle the display from "1,OFF", to "2,MIXED", "3,GLOBAL" or "4,SCHED".



**NOTICE**



The Mixed setting allows the operator to set different amounts of Cook Cycles, between filters, for each product. If the operator wants to have one setting for all products go to step h.

**MIXED**

- d. If "2,MIXED" is selected, press  and "SP-8A" shows in the display followed by "SUGGEST FILTER AT ..." and a value between 75% and 100%. Press and release the   to change this value.

- e. Press  and "SP-8B" shows in the display followed by "LOCKOUT ENABLED?" and "YES" or "NO". Press and release   to choose YES or NO.



- f. Press  and "SP-8C" shows in the display. "FILTER LOCKOUT AT..." and a value between 100% and 200% show in display. Press   to change this value.

- g. Press  and "SP-8D" shows in the display, if YES was chosen in step e. "LOCKOUT – HEAT OIL..." and a temperature show in the display. This allows the fryer to heat to this set temperature before filtering. Press   to set the desired temperature, 250-380°F (121-193°C).

**2-3. SPECIAL PROGRAM MODE (Continued)**







- h. Now, go back to the Product Program mode, to the Filter Cycle, and program in the number of cook cycles between filtering.

**GLOBAL**



- i. If "3,GLOBAL" is selected, "SP-8A" shows in the display, and followed by "GLOBAL FILTER CYCLES". The right side of the display shows a digit, 1 to 99. Press   to set the desired amount of cook cycles between filters.

**NOTICE**

In cook mode, the number of global cook cycles remaining shows in the center of the display.  
Ex: "----- 5x -----".

- j. Press  **PROG** and "SP-8B" shows in the display followed by "LOCKOUT ENABLED?" and "YES" or "NO". Press and release   to choose yes or no.
- k. Press  **PROG** and "SP-8C" shows in the display display, if YES was chosen in step e. "LOCKOUT – HEAT OIL..." and a temperature shows in the display. This allows the fryer to heat to this set temperature before filtering. Press   to set the desired temperature, 250-380°F (120-190°C).
- l. Now, go back to section 2-2 and enter the Program mode. Press  **PROG** until "FILTER INCL" shows in the display (step 13). Each product must be set to "YES" to be included in the filter tracking.

**SCHEDULE**

- m. If "4,SCHED" is selected, "SP-8A" shows in the display, and followed by "SCHEDULE". Press  **PROG** and up to 4 different times of day can be programmed, by pressing   . EX:



SP-8A	"SCHEDULE"	F1: 10.00A
SP-8B	"SCHEDULE"	F2: 2.00P
SP-8C	"SCHEDULE"	F3: 8.00P
SP-8D	"SCHEDULE"	F4: - - - -



Unneeded times should be left at "- - - -", otherwise, "Filter Suggested" shows in the display, prompting the operator to start filtering.



**2-3. SPECIAL PROGRAM  
MODE (Continued)**

**NOTICE**

Cooking is still permitted during the “suggested” phase. However, if lockout is enabled, and the fryer still has not been filtered after one hour, then the controller activates lockout mode and prompts “FILTER LOCKOUT – YOU \*MUST\* FILTER NOW”.





- n. Press  and “SP-8E” “SKIP IF LESS THAN...” shows in the display, followed by the number of loads between filters, ex: “LOAD 4”. In this example, if the suggested filter time occurs, before 4 loads have been cooked, then the filter operation is skipped. If more than 4 loads have been cooked, then “Filter Suggested” shows in the display. The numbers of loads can be set by pressing  .

- o. Press  and “SP-8F” shows in the display, followed by “LOCKOUT ENABLED?” Press   to choose “YES” or “NO”.

- p. Press  and “SP-8G” shows in the display followed by SP-8G “LOCKOUT - HEAT OIL...” and a shortening temperature, when reached, allows the operator to filter. Example, “LOCKOUT - HEAT OIL... 300F” means the display shows “FILTER LOCKOUT” “WAIT”, until 300F is reached, then display shows “FILTER LOCKOUT”/“YOU \*MUST\* FILTER NOW”, and repeated high-low tones are activated. This prompts the user that it is now time to filter the shortening. Press   to change.

**Product Buttons (Sp-9)**



This mode allows you set up the way products are selected, and cook cycles started, in the Cook Mode.

- a. Follow steps 1 and 2 above.
- b. Press and release  until “SP-9” and “PRODUCT BUTTONS” flashes in the display.
- c. When using the first option, “1,COOK”, pressing a Product button displays that product and starts the cook cycle. When nothing is cooking, no product displays.
- d. Press   to show the second option. If using “2,SELECT”, pressing a Product button displays the product only. Press  to start the Cook Cycle.

**2-3. SPECIAL PROGRAM  
MODE (Continued)**



**Clean-Out Minutes (Sp-10)**

This allows you to set the number of minutes of the Clean-Out Mode.



- a. Follow steps 1 and 2 above.
- b. Press  **PROG** until “SP-10” and “CLEAN-OUT MINUTES” shows in display, along with the preset minutes.
- c. Press   to change the number of minutes, up to 99.

**Clean-Out Temperature (Sp-11)**

This allows you to set the temperature of the Clean-Out Mode.



- a. Follow steps 1 and 2 above.
- b. Press  **PROG** until “SP-11” and “CLEAN-OUT TMP” shows in display, along with the set temperature.
- c. Press   to change the temperature, up to 212°F (100°C).

**Nominal Amps Reading (SP-12)**

- a. Press  **PROG** until “SP-12”, “AMPS RDG, NOMINAL” shows in display.
- b. Check the amp reading on the right side of display (ex: “37 A”) with the amp reading on the data plate. If readings are different, use   to change display to match data plate. (This could vary depending upon how the unit is wired.)

**Amps Reading Low Limit (SP-13)**



This is the percentage below the Nominal Amp Reading in which the controls senses a too low amperage warning (E27). Preset at 80%, but can be changed (50 to 99%):

- a. Follows steps 1 and 2 above.
- b. Press  **PROG** until "SP-13" and "AMPS RDG, LOW LIMIT" shows in the display, along with the preset percentage.
- c. Press   to change percentage.

**2-3. SPECIAL PROGRAM  
MODE (Continued)**





**Amps Reading High Limit (SP-14)**

This is the percentage above the Nominal Amp Reading in which the controls senses a too high amperage warning (E25). Preset at 110%, but can be changed (101 to 150%):

- a. Follow steps 1 and 2 above.
- b. Press  until "SP-14" and "AMPS RDG, HIGH LIMIT" shows in display, along with the preset percentage.
- c. Press and release   to change percentage.

**Program Code Change (SP-15)**

This allows the operator to change the program code (factory set at 1, 2, 3) used to access Product Programming, Special Programming, Clock Set, Data Comm, and Heat Control Modes.





- a. Follow steps 1 and 2 above.
- b. Press  until "SP-15" and "CHANGE, MGR CODE? 1=YES" shows in display, along with "CODE".
- c. Press . "ENTER NEW CODE, P=DONE, I=QUIT" shows in display. Press product buttons with new code.
- d. If satisfied with code, press . "REPEAT NEW CODE, P=DONE, I=QUIT" shows in display. Press same code buttons in step c.
- e. If satisfied with code, press . "\*CODE CHANGE\*" shows in display.
- f. If not satisfied with code, press  and "\*CANCELLED\*" shows in display, then reverts back to "SP-15" and "CHANGE, MGR CODE? 1=YES". Then the above steps can be repeated.

**Usage Code Change (SP-16)**

This allows the operator to change the reset usage code (factory set at 1, 2, 3) to reset the usage amounts of each product. See Review Usage step in Information Mode.



- a. Follow steps 1 and 2 above.
- b. Press  until "SP-16" and "CHANGE, USG CODE ? 1=YES" shows in display, along with "USAGE".

**2-3. SPECIAL PROGRAM  
MODE (Continued)**

- c. Press , "ENTER NEW CODE, P=DONE, I=QUIT" shows in display. Press product buttons with new code.
- d. If satisfied with code, press . "REPEAT NEW CODE, P=DONE, I=QUIT" shows in display. Press same code buttons in step c.
- e. If satisfied with code, press . "\*CODE CHANGE\*" shows in display.
- f. If not satisfied with code, press  and  and "CANCELLED" shows in display, then reverts back to "SP-16" and "CHANGE USG CODE ? 1=YES". Then the above steps can be repeated.



**Change Shortening-A-Cook Cycles (SP-17)**

The operator can set a reminder to filter the shortening, based on the number of Cook Cycles accumulated. The display shows "CHANGE OIL SOON" when the preset number of Cook Cycles has been met, "OFF" to 5000, increments of 10.

- a. Follow steps 1 and 2 above.
- b. Press  until "SP-17" and "CHANGE OIL' A – COOK CYCLES" shows in display, along with a number of Cook Cycles.
- c. Press and release   to change the number of Cook Cycles.

**Change Shortening-B-Hours (SP-18)**

The operator can set a reminder to filter the shortening, based on the number of power-on hours accumulated. The display shows "CHANGE OIL SOON" when the preset number of hours has been met, "OFF" to 999 hours.

- a. Follow steps 1 and 2 above.
- b. Press  until "SP-18" and "CHANGE OIL' B – HOURS" shows in display, along with a number of hours.
- c. Press and release   to change the number of power-on hours.

**NOTICE**

Once the shortening is filtered, to clear the display of "CHANGE OIL SOON" (SP-17 & SP-18), reset the review usage data in the Information Mode. See Information Mode section of this manual.

Press and hold  at any time to exit Special Program Mode.

**2-4. DATA LOGGING, HEAT CONTROL, TECH, AND STAT MODES**

The Data Logging, Heat Control, Tech and Stat Modes are advanced diagnostic and program modes, mainly for Henny Penny use only. For more information on these Modes, contact the Service Department at 1-800-417- 8405, or 1-937-456-8405.

**2-5. PROGRAM SETTINGS WORKSHEETS**

The next two pages are worksheets for your convenience. They may be helpful in determining and recording setpoints.

Henny Penny Computron 8000  
Product Settings Worksheet

Customer \_\_\_\_\_  
Date \_\_\_\_\_

Button #		Product Description:				
Name:	_____ (7 Characters Max)			Alarm-1		
PreLoad:	(Always uses Step 1 Temp.)			Alarm-2		
	<u>Time</u>	<u>Temp.</u>	<u>Pressure</u>	Alarm-3		
Step 1			YES NO	Alarm-4		
Step 2			YES NO			
Step 3			YES NO	Quality Timer		
Step 4			YES NO	Load Comp		
Step 5			YES NO	LComp Ref.		
Step 6			YES NO	Go To Idle when done?	YES	NO
Step 7			YES NO			
Step 8			YES NO	-- Optional Filter settings -- Only one (or neither one) appears		
Step 9			YES NO	Filter After...		
Step 10			YES NO	Filter Include?	YES	NO

Button #		Product Description:				
Name:	_____ (7 Characters Max)			Alarm-1		
PreLoad:	(Always uses Step 1 Temp.)			Alarm-2		
	<u>Time</u>	<u>Temp.</u>	<u>Pressure</u>	Alarm-3		
Step 1			YES NO	Alarm-4		
Step 2			YES NO			
Step 3			YES NO	Quality Timer		
Step 4			YES NO	Load Comp		
Step 5			YES NO	LComp Ref.		
Step 6			YES NO	Go To Idle when done?	YES	NO
Step 7			YES NO			
Step 8			YES NO	-- Optional Filter settings -- Only one (or neither one) appears		
Step 9			YES NO	Filter After...		
Step 10			YES NO	Filter Include?	YES	NO

Henny Penny Computron 8000  
SP PROG Settings Worksheet

Customer \_\_\_\_\_  
Date \_\_\_\_\_

<b>SP-1 Temperature Units</b>	°F	°C
<b>SP-2 Language</b>	1. English 2. Français 3. Deutsch 4. Español 5. Portuguese (English) (French) (German) (Spanish) (Portuguese)	
<b>SP-3 Initialize Step</b>	XX	
<b>SP-4 Audio Volume</b>	1 2 3 4 5 6 7 8 9 10	
<b>SP-5 Audio Tone (Hz)</b>	(Frequency, 50 - 2000 Hz)	
<b>SP-6 Melt Cycle Select</b>	1. SOLID	2. LIQUID

<b>SP-7 Idle Mode Enabled?</b> (Select YES or NO below and complete corresponding section)		
YES	<b>SP-7A Idle Setpoint Temp</b>	
	<b>SP-7B Auto-Idle Minutes</b>	
	<b>SP-7C Go to Idle at Melt Exit?</b>	YES NO
NO	XXXXXXXXXXXXXXXXXXXXXXXXXXXXXXXXXXXX	XXXXXXXXXXXXXXXXXXXXXXXXXXXXXXXXXXXX

<b>SP-8 Filter Tacking Mode</b> (Select 1, 2, or 3 below and complete corresponding section)		
1. OFF	XXXXXXXXXXXXXXXXXXXXXXXXXXXXXXXXXXXX	XXXXXXXXXXXXXXXXXXXXXXXXXXXXXXXXXXXX
2. MIXED	<b>SP-8A Suggest Filter At...</b>	
	<b>SP-8B Lockout Enabled?</b>	YES NO
	<b>SP-8C Filter Lockout At...</b>	
3. GLOBAL	<b>SP-8A Global Filter Cycles</b>	
	<b>SP-8B Lockout Enabled?</b>	YES NO

<b>SP-9 Product Buttons</b>	1. COOK	2. SELECT
<b>SP-10 Clean-out Minutes</b>		
<b>SP-11 Clean-out Temperature</b>		
<b>SP-12 Nominal Amps Reading</b>	Normal, expected current draw. ("OFF" for Gas fryers.)	
<b>SP-13 Amps Reading Low Limit</b>	Acceptable range below normal. ("OFF" for Gas fryers.)	
<b>SP-14 Amps Reading High Limit</b>	Acceptable range above normal ("OFF" for Gas fryers.)	
<b>SP-15 Manager's Access Code</b>		

## SECTION 3. ERROR CODES

### 3-1. INTRODUCTION

This section provides error codes and their information in the form of an easy-to-read table.

If a problem occurs during the first operation of a new fryer, recheck the installation section of the 500/561/600 Operator's manual.

### 3-2. ERROR CODE TABLE

In the event of a control system failure, the digital display shows an error message coded as follows: "E-1", "E-4", "E-5", "E-6", "E-10", "E-15", "E12", "E-20-A,B,C,D", "E-25", "E-26", "E-27", "E-41", "E-46", "E-47", "E-48", "E-70A", "E-70B", & "E-92". An alarm sounds when an error code is displayed, and to silence this alarm, press any button.

DISPLAY	CAUSE	PANEL BOARD CORRECTION
"E-1" (FPS equipped fryers only)	No shortening or low shortening in frypot	Check to make sure shortening is a proper level in frypot
"E-4"	Control board overheating	Turn switch to OFF position, then turn switch back to ON; if display shows "E-4", the control board is getting too hot; check the louvers on each side of the unit for obstructions; check cooling fan, if present
"E-5"	Shortening overheating	Turn switch to OFF position, then turn switch back to ON; if display shows "E-5", the heating circuits and temperature probe should be checked
"E-6A"	Temperature probe open	Turn switch to OFF position; then turn switch back to ON; if display shows "E-6", have the temperature probe checked
"E-6B"	Temperature probe shorted	Turn switch to OFF position, then turn switch back to ON; if display shows "E-6", have the temperature probe checked
"E-10"	High limit	Reset the high limit by manually pushing up on the reset button; if high limit does not reset, high limit must be replaced

**3-2. ERROR CODE TABLE**  
**(Continued)**





DISPLAY	CAUSE	PANEL BOARD CORRECTION
“E-12 (FPS Equipped Fryers only)	Faulty FPS probe	Turn switch to OFF position, then turn switch back to ON; if display shows “E-12”, have the FPS probe checked
“E-15”	Drain switch failure	Close drain, using the drain valve handle; if display still shows “E-15”, have the drain microswitch checked
“E-20C” (gas fryers only)	Ignition module(s) failure	Press the timer button to try the ignition process again, and if “E-20C” persists, have ignition modules checked
“E-20D” (gas fryers only)	No ignition	Press the timer button to try the ignition process again, and if “E-20D” persists, have gas valve and gas flow checked
“E-25” (electric fryers only)	Heat amps too high	Have electrical supply, wiring and elements checked
“E-26” (electric fryers only)	Heat amps locked on	Have the contactors and PC board checked  <div style="text-align: center; border: 2px solid black; padding: 5px; width: fit-content; margin: 0 auto;"><b>NOTICE</b></div> <p>This error code could be displayed even with the Power switch turned OFF. Unplug fryer or shut off the wall circuit breaker to disconnect power to the fryer.</p>
“E-27” (electric fryers only)	Heat amps too low	Have electrical supply, contactors, wiring and elements checked

**3-2. ERROR CODE TABLE**  
**(Continued)**

<b>DISPLAY</b>	<b>CAUSE</b>	<b>PANEL BOARD CORRECTION</b>
“E-41” “E-46”	Programming failure	Turn switch to OFF, then back to ON; if display shows any of the error codes, try to reinitialize the control (paragraph 2-3); if error code persists, have the control board replaced
“E-47”	Analog converter chip or 12-Volt supply failure	Turn switch to OFF, then back to ON; if “E-47” persists, have the I/O board, or the PC board replaced; if speaker tones are quiet, probably I/O board failure
“E-48”	Input system error	Have PC board replaced
“E-70A”	Missing or broken wire in pins 1 and 2 of P11 connector, or faulty connector  Faulty I/O board  Open interlock on PVS units	Have jumper wire between pins 1 and 2 checked  Have I/O board checked and replaced, if necessary  Have fan, extinguisher switch, side panel switches, and air pressure switch circuits checked
“E-70B”	Faulty power switch, or switch wiring; faulty I/O board	Have Power switch checked, along with its wiring; have Input/Output board replaced, if necessary
“E-92”	24-VAC fuse on I/O board open	24-VAC fuse on I/O Board open; check for shorted component in 24-volt circuit (i.e., hi limit, drain switch)

## SECTION 4. INFORMATION MODE

### 4-1. INFORMATION MODE FUNCTIONS

This mode gathers and stores historic information on the fryer and operator's performance. Press  and  at the same time and “\*INFO MODE\*” shows on display. Press  or  to access the steps and press  to view the statistics within each step. Information Mode is intended for technical use, but the operator can view the following information:

1. **E-LOG** - last 10 errors and time they occurred
2. **LAST LOAD** - information about the most recent Cook Cycle, or the cycle presently in progress
3. **DAILY STATS** - information for the last 7 days
4. **REVIEW USAGE**- information accumulated since the last time this data was manually reset
5. **INP A\_VHDSF\_M** - provides test of fryer inputs
6. **OUTP** - shows the state of heater and pressure
7. **OIL TMP** - temperature of shortening
8. **CPU TMP** - temperature of PC board
9. **ANALOG** - status of controller's a-to-d converter
10. **AMPS** - the present amp readings to heaters

### NOTICE

Press and hold  to exit Information Mode at any time, or after 2 minutes, controls automatically exit back to normal operation.

#### **1. E-LOG** (error code log)

Press  and “1A. (date & time) \*NOW\*” shows in display. This is the present date and time.

Press  and if an error was recorded, “1B. (date, time, and error code information)” shows in display. This is the latest error code that the controls recorded.

**4-1. INFORMATION MODE  
FUNCTIONS (Continued)**

Press  and the next latest error code information can be seen. Up to 10 error codes (1B to 1K) can be stored in the E-LOG section.

Press  to continue to LAST LOAD.

**2. LAST LOAD**

Press  to view the following information from the most recent Cook Cycle.

<b>FUNCTION</b>	<b>DISPLAY EX:</b>
Time of day the last Cook Cycle was started	STARTED 10.25A
Product (Last product cooked)	PRODUCT -2-
Ready? (Was fryer Ready before start?)	READY? YES
Stopped: Time remaining, or secs past Done	*DONE* + 9 SECS
Actual Elapsed cook Time (Real seconds)	ACTUAL TIME 7:38
Programmed cook Time	PROG TIME 7:00
Actual Time vs. Prog time (Percentage)	ACT / PROG 109%
Max Temp during Cook Cycle	MAX TEMP 327°F
Min Temp during Cook Cycle	MIN TEMP 313°F
Avg Temp during Cook Cycle	AVG TEMP 322°F
Heat On (percentage) during Cook Cycle	HEAT ON 73%



*Only if Presently Cooking:*

Present cook step, setpoint, and time rem.	STEP 1:325°F 6:47
Actual shortening temp, deg below load comp avg, present stretch time (real secs / ck sec)	313°F LC-12° 1.06

Press  to continue to DAILY STATS.

**4-1. INFORMATION MODE  
FUNCTIONS (Continued)**

**3. DAILY STATS** (reset each day)

Press  to view the following operation information for any of the last 7 days. Press  to select which day.

<b>FUNCTION</b>	<b>DISPLAY EX:</b>
Day this data was recorded for	TUE* APR-30
No. of Hours:Minutes the fryer was on	TUE* ON HRS 13:45
No. of times shortening was filtered that day	TUE* FILTERED 3
Total number of cook cycles that day	TUE* TOTAL CK 38
Cook Cycles stopped before "DONE" that day	TUE* QUIT COOK 4
Cook Cycles for Product #1	TUE* COOK -1- 17
Cook Cycles for Product #2	TUE* COOK -2- 9
Cook Cycles for Product #3	TUE* COOK -3- 5
Cook Cycles for Product #4	TUE* COOK -4- 0
Cook Cycles for Product #5	TUE* COOK -5- 0
Cook Cycles for Product #6	TUE* COOK -6- 6
Cook Cycles for Product #7	TUE* COOK -7- 0
Cook Cycles for Product #8	TUE* COOK -8- 0
Cook Cycles for Product #9	TUE* COOK -9- 1
Cook Cycles for Product #0	TUE* COOK -0- 0

Press  to continue to REVIEW USAGE.

**4. REVIEW USAGE**

Press  to view the accumulated information since the data was manually reset:

<b>FUNCTION</b>	<b>DISPLAY EX:</b>
Day the usage data was previously reset	SINCE APR-19
Number of hours the fryer was on	PWR ON HRS 165
Number of times shortening was filtered	FILTERED 34
Total number of cook cycles	TOTAL CK 462
Cook Cycles stopped before "DONE"	QUIT COOK 4
Oil Wear based on Number of Cook Cycles	OIL WEAR 'A' 83%
Oil Wear based on Running Hours	OIL WEAR 'B' 55%
Cook Cycles for Product #1	COOKED -1- 193
Cook Cycles for Product #2	COOKED -2- 107
Cook Cycles for Product #3	COOKED -3- 58
Cook Cycles for Product #4	COOKED -4- 0
Cook Cycles for Product #5	COOKED -5- 13
Cook Cycles for Product #6	COOKED -6- 69
Cook Cycles for Product #7	COOKED -7- 0
Cook Cycles for Product #8	COOKED -8- 7
Cook Cycles for Product #9	COOKED -9- 15
Cook Cycles for Product #0	COOKED -0- 0
<b>Reset usage data:</b> Enter the Mgr Code (1, 2, 3 unless changed) on this step to zero out all the usage info.	RESET USG / ENTER CODE -----

Press  to continue to INP A\_VHDSF\_M.

**4-1. INFORMATION MODE**  
**FUNCTIONS (Continued)**

**5. INP A\_VHDSF\_M**

Press  to view the status of components and inputs. If the input signal is detected, an identifying letter is displayed (see below). If the signal is not detected, “\_” is displayed.

With the COOK /PUMP switch in the COOK position, and all inputs detected, “A\_VHDSF\_M” shows in the display (“A\_VHDSFP\_” for gas units). See below for definition of codes.

A = Power Switch in COOK position.

B = Power Switch in PUMP position

V = Volts - 24 VAC detected

D = DRAIN SWITCH-If “D” is present, the drain handle is closed. If “D” is missing, the drain is open or faulty.

S = COOK/PUMP switch “on” interlock circuit: If “S” is present, the COOK/PUMP switch is in the COOK position. If the “S” is missing, the power switch is either off, failed, or wired incorrectly.

F = FAN

P = PV – Detects 24 V jumper to PV terminal – gas fryers only

M = MV - Detects 24 V jumper to MV terminal - electric fryers only

Press  to view the specific status of each input. An underscore (“\_”) indicates the input is not presently detected. A Checkmark (“√”) indicates the signal is detecting a normal input. A blinking (“X”) indicates the signal is presently detected, but is detected as a half-wave (partially failed) input.

**NOTICE**

The V, H, D, S, F, P and M signals below are wired in series. The first signal missing out of this sequence l generally causes all signals to the right of it to be missing as well.

Press  to continue onto OUTP H\* P\_.

**4-1. INFORMATION MODE  
FUNCTIONS (Continued)**

**6. OUTP H\* P\_ (F\*H\*P\_ for gas units)**

This mode displays the status of components and outputs. If the output signal is detected, an identifying letter is displayed (see below), followed by an “\*”. If the output is off, “\_” is displayed.

F = Fan output (gas only)

H = Heat output

P = Pressure output

On gas units, if fan is on, “F\*” shows in display. If fan is off, “F\_” shows in display. If controls sense a problem with the fan output, “F\*” shows in display, with the “\*” flashing.

If heat is on, “H\*” shows in display. If heat is off, “H\_” shows in display. If controls sense a problem with the heat output, “H\*” shows in display, with the “\*” flashing.

If pressure is on, “P\*” shows in display. If pressure is off, “P\_” shows in display. If controls sense a problem with the pressure output, “P\*” shows in display, with the “\*” flashing.

Press  to view the amp “DRAW” status of each output. “F √”, “H √” and “P √” in the display means the amps are good. A flashing “X” behind the F, H or P means too much current.

Press  to view the No Connect/Ground (“NC/GND”) status of each output. This monitors a possible problem with the relays on the output PC board.

“F √”, “H √” and “P √” in the display means everything on the output PC board is good. A flashing “X” behind the F, H or P means a problem exists.

Press  to view the outputs and inputs (see step 10) together.

Press  to continue onto the OIL TMP reading.

**7. OIL TMP**

This step shows the present peanut shortening temperature. The display shows “7. OIL TMP (temp.)”.

Press  to continue onto the CPU TMP reading.

**4-1. INFORMATION MODE  
FUNCTIONS (Continued)**

**8. CPU TMP**

This step shows the present PC board temperature.

Press  to continue on to the ANALOG reading.  
PROG

**9. ANALOG <1> 2.86V**

This step displays the present status of any channel of the controller's a to d converter. This feature may be useful to a technician troubleshooting a problem with the fryer or controller.

The displayed value can be toggled between volts and bits by pressing . If the displayed value has a decimal point, it is voltage (0 to 5 VDC). If no decimal point is shown, the value is a-to-d bits (0 - 4095).

Press  to continue onto AMPS reading.  
PROG

**10. AMPS 33 33 33**

This display shows the present readings from the fryer's amps sensors, which monitor the electrical current supplied to the heaters.

These values indicate the current through each supply leg to the heaters. These values do not necessarily correspond directly to the current through an individual heater coil.

The AMPS values should normally cycle on and off with the heat light, and all three values should be about the same.

**NOTICE**

Press and hold  to exit Information Mode at any time, or after 2 minutes, controls automatically exit back to normal operation.  
PROG

## **SECTION 5. PARTS INFORMATION & WIRING DIAGRAMS**

### **5-1. INTRODUCTION**

This section identifies and lists the replaceable parts of the Henny Penny Computron 8000.

### **5-2. GENUINE PARTS**

Use only genuine Henny Penny parts in your fryer. Using a part of lesser quality or substitute design may result in fryer damage or personal injury.

### **5-3. HOW TO ORDER**

Once the part you want to order has been found in the Parts List, write down the following information:

1. From the Parts List

(Sample)  
Item Number 13  
Part Number 29898  
Description Power Switch

2. From the data plate

(Sample)  
Product Number PFE-500.0  
Serial Number 0001  
Voltage 208V

### **5-4. PRICES**

Your distributor has a price parts list and will be glad to inform you of the cost of your parts order.

### **5-5. DELIVERY**

Commonly replaced items are stocked by your distributor and will be sent out when your order is received. Other parts will be ordered by your distributor from Henny Penny Corporation. Normally, these will be sent to your distributor within three working days.

### **5-6. WARRANTY**

All replacement parts (except lamps and fuses) are covered under warranty for 90 days against manufacturing defects and workmanship. If damage occurs during shipping, notify the carrier at once so that a claim may be properly filed. Refer to warranty on the front of this section for other rights and limitations.

### **5-7. RECOMMENDED SPARE PARTS FOR DISTRIBUTORS**

Recommended replacement parts, stocked by your distributor, are indicated with √ in the parts lists. Please use care when ordering recommended parts, because all voltages and variations are marked. Distributors should order parts based upon common voltages and equipment sold in their territory.

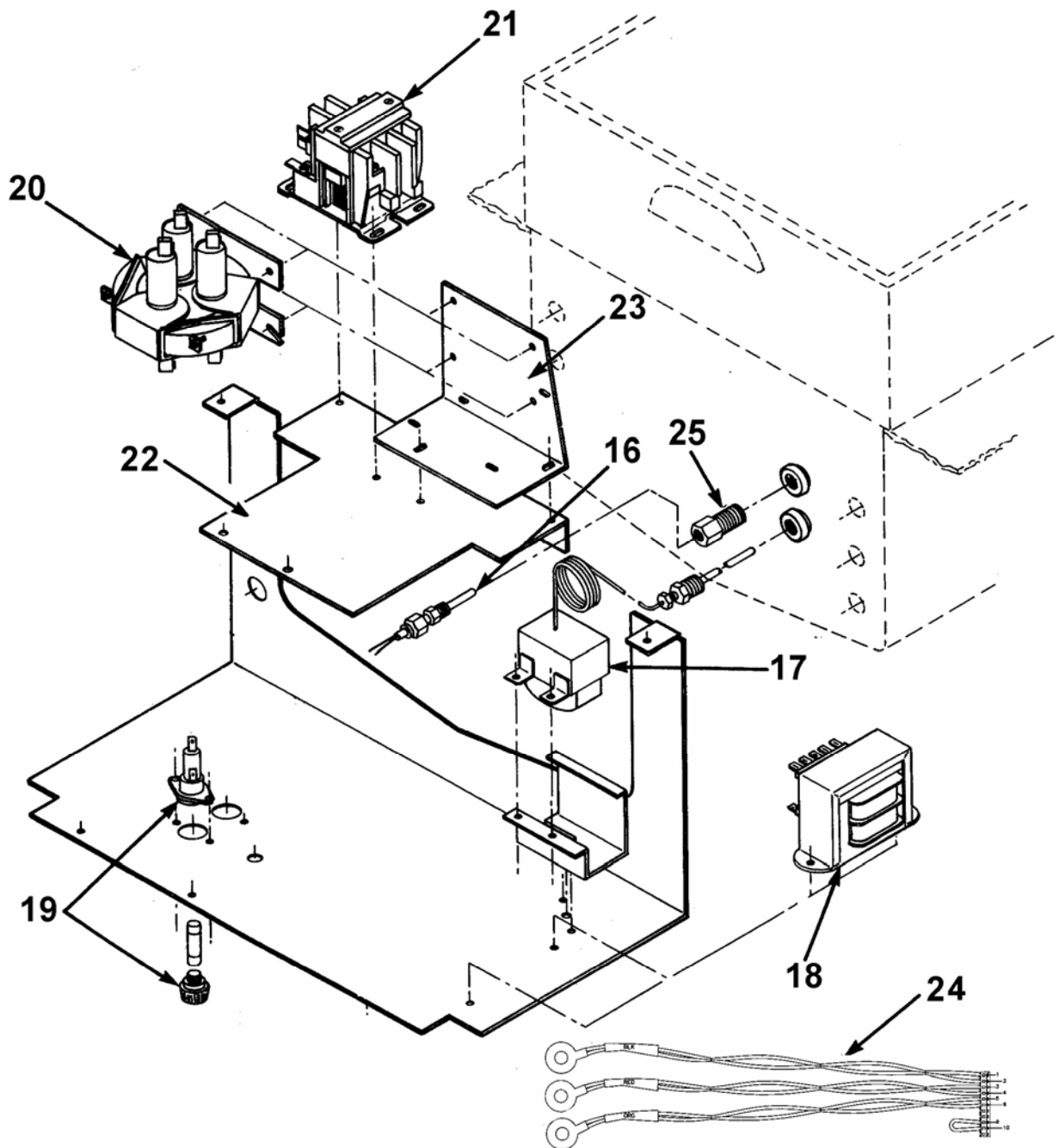

Figure 5-1. Computron 8000-500 – 3 phase Exploded View

Figure & Item Number	Part Number	Description	Qty
Figure 1-1		Control Panel	
11	32633	Card – C8000 Std. Product Menu	1
11	32634	Card – C8000 Blank Menu	1
11	69228	Card – C8000 Campero	1
11	39089	Card – C8000 Jollibee’s	1
11	39156	Card – C8000 Wendy’s/Davco	1
11	68731	Card – C8000 Giant Eagle	1
11	70846	Card – C8000 McDonalds	1
√ 13	29898	Power Switch	1
15	27308	Decal – Control – Bent	1
15	24849	Decal – Control – Flat	1
15	32658	Decal – C8000-02	1
15	39269	Decal – C8000-02 – Wendy’s	1
15	72170	Decal – C8000-02 – Wendy’s Eng/Fre	1
Figure 5-1		Computron 8000 Exploded View	
√ 16	14785	Assembly – Probe/Compression Fitting – Ele.	1
√ 17	16738	High Limit – 450 degree F.	1
√ 18	72854	Assembly – Transformer - 10/24 VAC	1
√ 19	18364	Assembly – Fuse Holder – 15 amp	2
√ 19	EF02-007	Fuse – 15 amp	2
√ 20	29510	Contactora – Mercury – 24 VAC	1
√ 20	65073	Contactora – Square D - 24 VAC - CE	1
√ 21	29509	Contactora – 24 VAC	1
22	58850	Bracket – Double Contactora	1
23	66717	Stud Assembly – Contactora Bracket	1
√ 24	24347	Assembly – Current Sense Transformers	1
√ 25	FP01-024	Bushing – Pipe – 1/8 - 3/8	1
√ 26*	26974	Assembly – Speaker	1
27*	29515	Solenoid – 24 Volt – 60 Hz.	1
27*	29698	Solenoid – 24 Volt – 50 Hz.	1
√ 27*	29547	Solenoid Coil – 24 Volt – 50/60 Hz.	1
√ 27*	29575	Coil – Solenoid – 24VAC – 50 Hz	1
28*	63294	Insulation – Fryer Pot – 1/4”	1
28*	63295	Insulation – Fryer Pot – 1/8”	1

√ recommended parts  
 \*not shown

<b>Figure &amp; Item Number</b>	<b>Part Number</b>	<b>Description</b>	<b>Qty</b>
√ 29*	32612RB	Assembly – Control 8000 Flat Panel (SN: KA021JJ to GA085JB-GAS) (SN: KB021JJ to HB013JB-ELEC.)	1
√ 29*	65465RB	Assembly – Control 8000 Flat Panel (SN: GA086JB and above-GAS) (SN: HB014JB and above-ELEC.)	1
√ 29*	32613RB	Assembly – Control 8000 Bent Panel (SN: KA020JJ and below-GAS) (SN: KB020JJ and below-ELEC.)	1
√ 29*	68798RB	Assembly – Control 8000 Bent Panel-Campero (SN: KA020JJ and below-GAS) (SN: KB020JJ and below-ELEC.)	1
√ 29*	68799RB	Assembly – Control 8000 Flat Panel-Campero (SN: KA021JJ to GA085JB-GAS) (SN: KB021JJ to HB013JB-ELEC.)	1
√ 29*	68800RB	Assembly – Control 8000 Flat Panel-Campero (SN: GA086JB and above-GAS) (SN: HB014JB and above-ELEC.)	1
√ 29*	65462RB	Assembly – Control 8000 Bent Panel– Jollibee’s (SN: KA020JJ and below-GAS) (SN: KB020JJ and below-ELEC.)	1
√ 29*	65463RB	Assembly – Control 8000 Flat Panel – Jollibee’s (SN: KA021JJ to GA085JB-GAS) (SN: KB021JJ to HB013JB-ELEC.)	1
√ 29*	65464RB	Assembly – Control 8000 Flat Panel– Jollibee’s (SN: GA086JB and above-GAS) (SN: HB014JB and above-ELEC.)	1
√ 29*	65171RB	Assembly - Control 8000 – Express Foods	1
√ 29*	65193RB	Assembly - Control 8000 – Servequip	1
√ 29*	68409RB	Assy - Control 8000 - 600 – Wendy’s w/SSI/FPS (SN: GA086JB and above-GAS)	1
√ 29*	68683RB	Assy - Control 8000 – Wendy’s w/SSI/FPS (SN: GA085JB and below-GAS)	1
√ 29*	70001RB	Assembly - Control 8000-’02-GM w/FPS	1
√ 29*	69307RB	Assembly - Control 8000-’02 – Giant Eagle	1
√ 29*	65097RB	PC Board Only – Wendy’s/Davco	1
√ 29*	14756	Assembly – Control 8000 – McDonalds	1
√ 30*	64120	PCB – Amp Sensor	1
√ 31*	65893RB	Assy – Dual Gas Module I/O W/PS	1

√ recommended parts

\*not shown

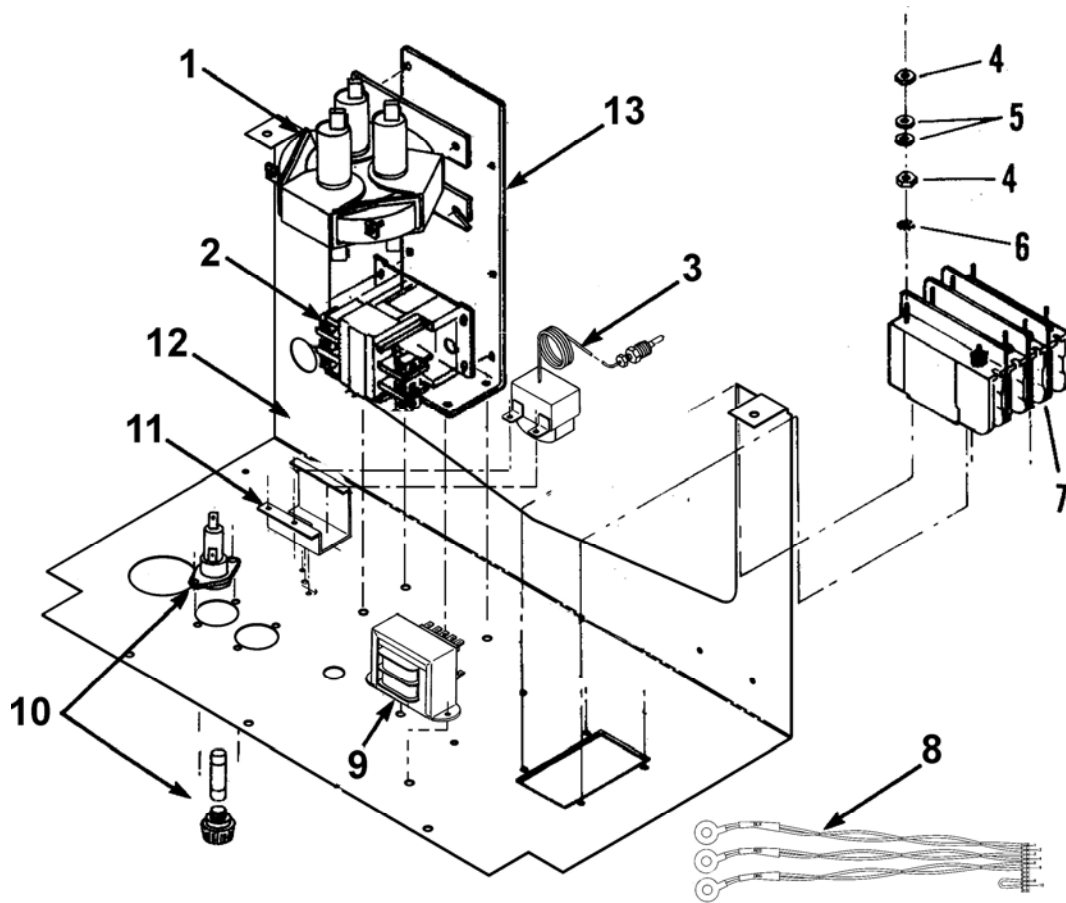

Figure 5-2. Computron 8000 - 500 - 1 phase Exploded View

Item Number	Part Number	Description	Qty
√ 1	29510	CONTACTOR, Mercury - 24 VAC	1
√ 1	65073	CONTACTOR - Square D - 24 VAC - CE	1
√ 2	29509	CONTACTOR - 24 Volt	1
√ 3	16738	CONTROL, High Limit Temperature	1
4	NS01-014	NUT, Hex	16
5	WA01-007	WASHER	16
6	LW02-005	LOCKWASHER	8
7	18242	BREAKER, CIRCUIT 50 amp	1
8	24347	ASSY, Current Sense Xformers	1
√ 9	72854	ASSY, Transformer - 10/24 VAC	1
√ 10	18364	ASSY, Fuse Holder - 15 amp	2
√ 10	EF02-007	FUSE, 15 amp	2
√ 10	EF02-006	HOLDER, Fuse	2
11	17216	ASSY, Bracket - High Limit	1
12	18244	SHROUD, Single Phase (KB020JJ & below)	1
12	63226	SHROUD, Single Phase (KB021JJ to HB013JB)	1
12	27418	SHROUD, Single Phase (HB014JB & above)	1
13	29687	BRACKET, Double Contactor	1

√ recommended parts  
108

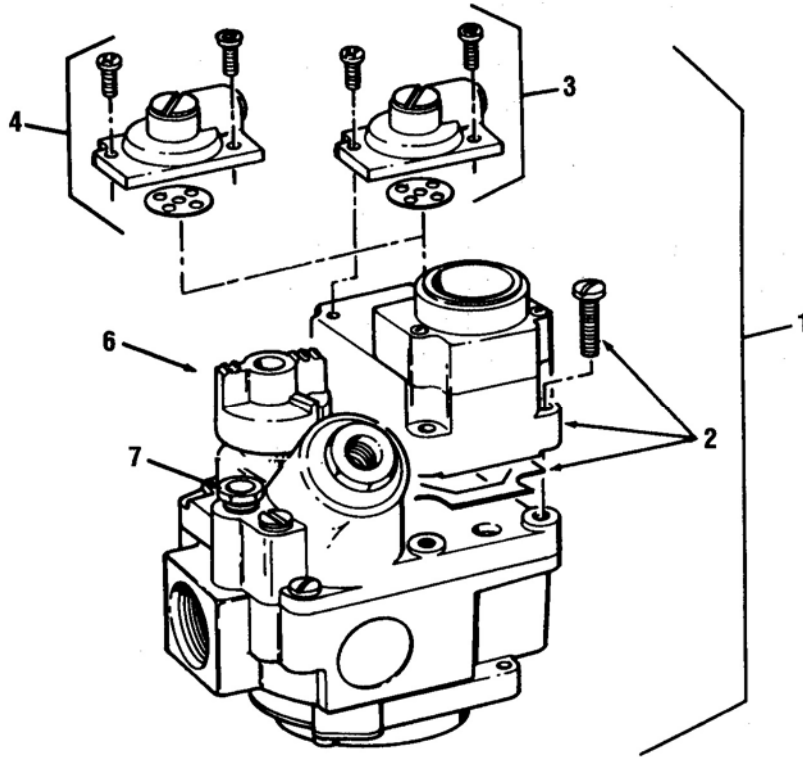

Figure 5-3. Computron 8000 - 600 – Gas Control Valve

ITEM NO.	PART NUMBER	DESCRIPTION	PER ASSY
√ 1a	58863	VALVE, Control, Natural Gas, 24 Volt - SN: KA021JJ & Above	1
√ 1a	16216	VALVE, Control, Natural Gas, 120 Volt	1
√ 1b	64036	VALVE, Control, Propane Gas, 24 Volt - SN: KA021JJ & Above	1
√ 1b	16217	VALVE, Control, Propane Gas, 120 Volt	1
√ 1a	16380	VALVE, Control, Natural Gas, 208-240 Volt	1
√ 1b	16381	VALVE, Control, Propane Gas, 208-240 Volt	1
√ 1a	29614	VALVE, Control, Natural Gas, 24 Volt-SN: KA020JJ & below	1
√ 1b	29728	VALVE, Control, Propane Gas, 24 Volt-SN: KA020JJ & below	1
√ 2	16254	OPERATOR, Gas Control Valve, 120 Volt, Natural	1
√ 2	16710	OPERATOR, Gas Control Valve, 208-240 Volt, Natural	1
√ 2	16386	OPERATOR, Gas Control Valve, 120 Volt, Propane	1
√ 2	16384	OPERATOR, Gas Control Valve, 208-240 Volt, Propane	1
√ 3	16253	REGULATOR, Gas Control Valve, Natural Gas	1
√ 4	16352	REGULATOR, Gas Control Valve, Propane Gas	1
√ 6	16267	KNOB, Gas Control Valve	1
√ 7	16373	FITTING, Compression - Pilot Tube	2

√ recommended parts

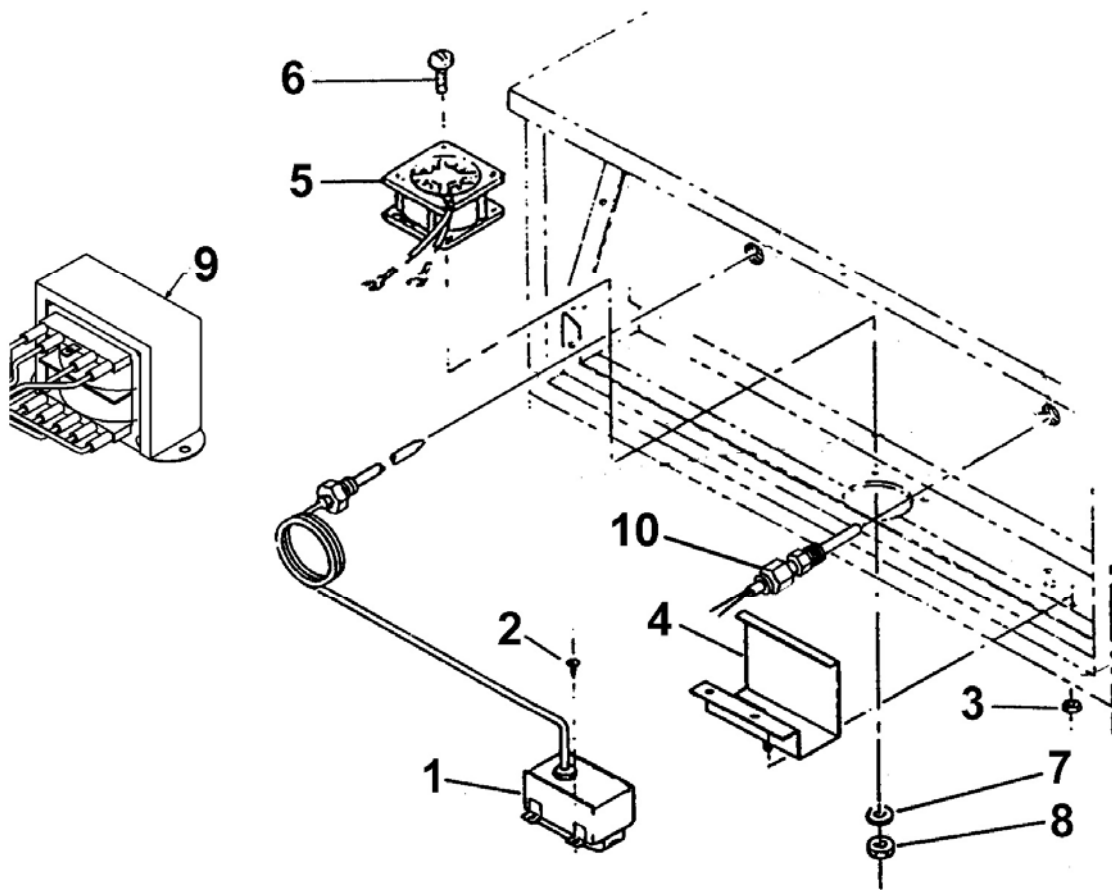

Figure 5-3. Computron 8000 - 600 – Gas Components

ITEM NO.	PART NUMBER	DESCRIPTION	PER ASSY
√ 1	16738	CONTROL, High Temperature Limit	1
2	SC02-018	SCREW, Thread Forming #8	2
3	NS02-001	NUT, #10-32 Hex Keys	2
4	17216	BRACKET ASSY, High Limit Thermostat	1
√ 5	16684	FAN, 120 Volt (where applicable)	1
6	SC01-010	SCREW, Fan	4
7	WA01-006	WASHER, Fan	4
8	NS02-005	NUT, Fan	4
√ 9	72854	ASSY, TRANSFORMER - 10/24 VAC	1
√ 10	14331	KIT, Temperature Probe	1
10	14877	Kit – 600 FPS Temp. Probe	1
√ 11*	36097	PROBE GUARD	1

√ recommended parts

\*not shown



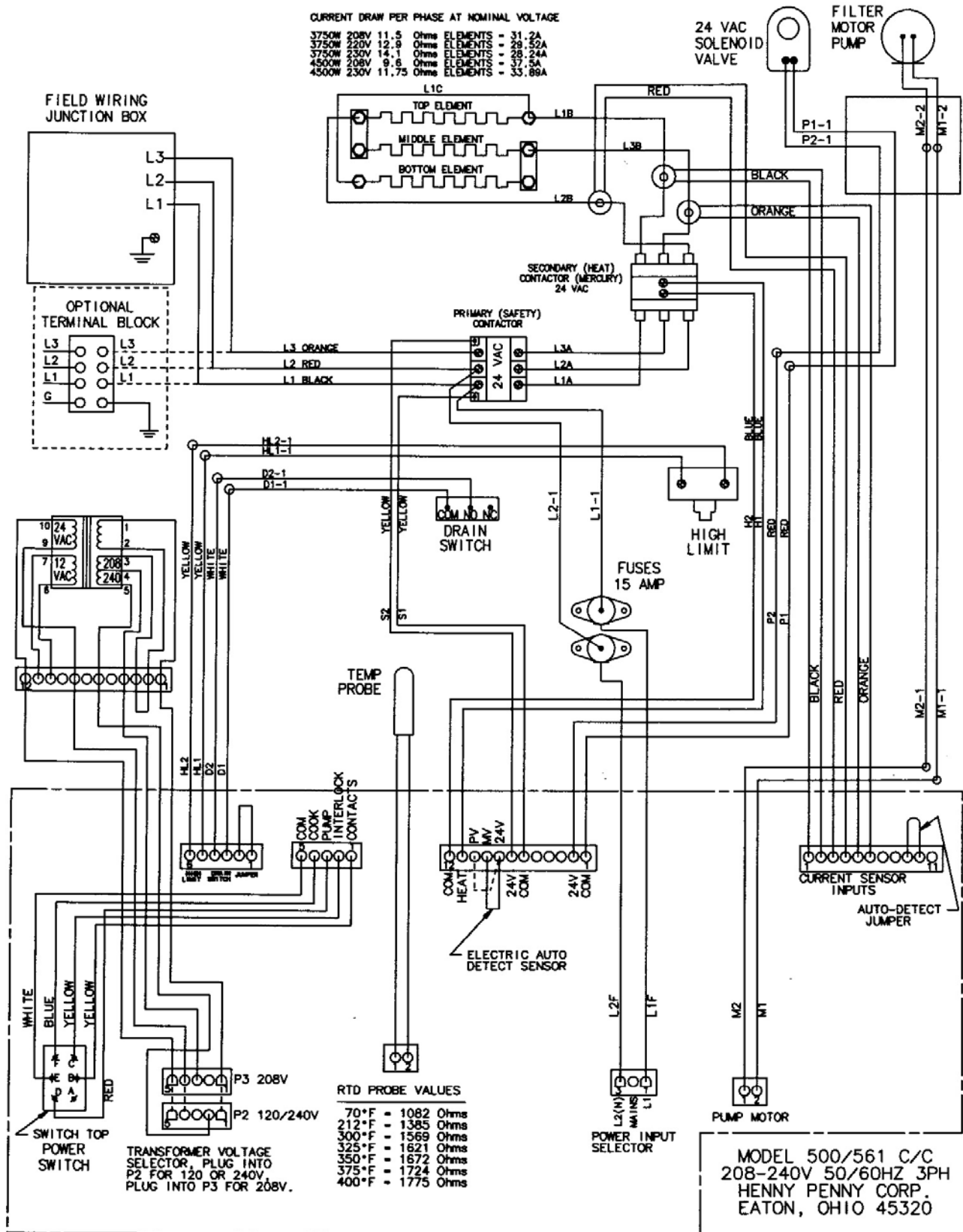

24674

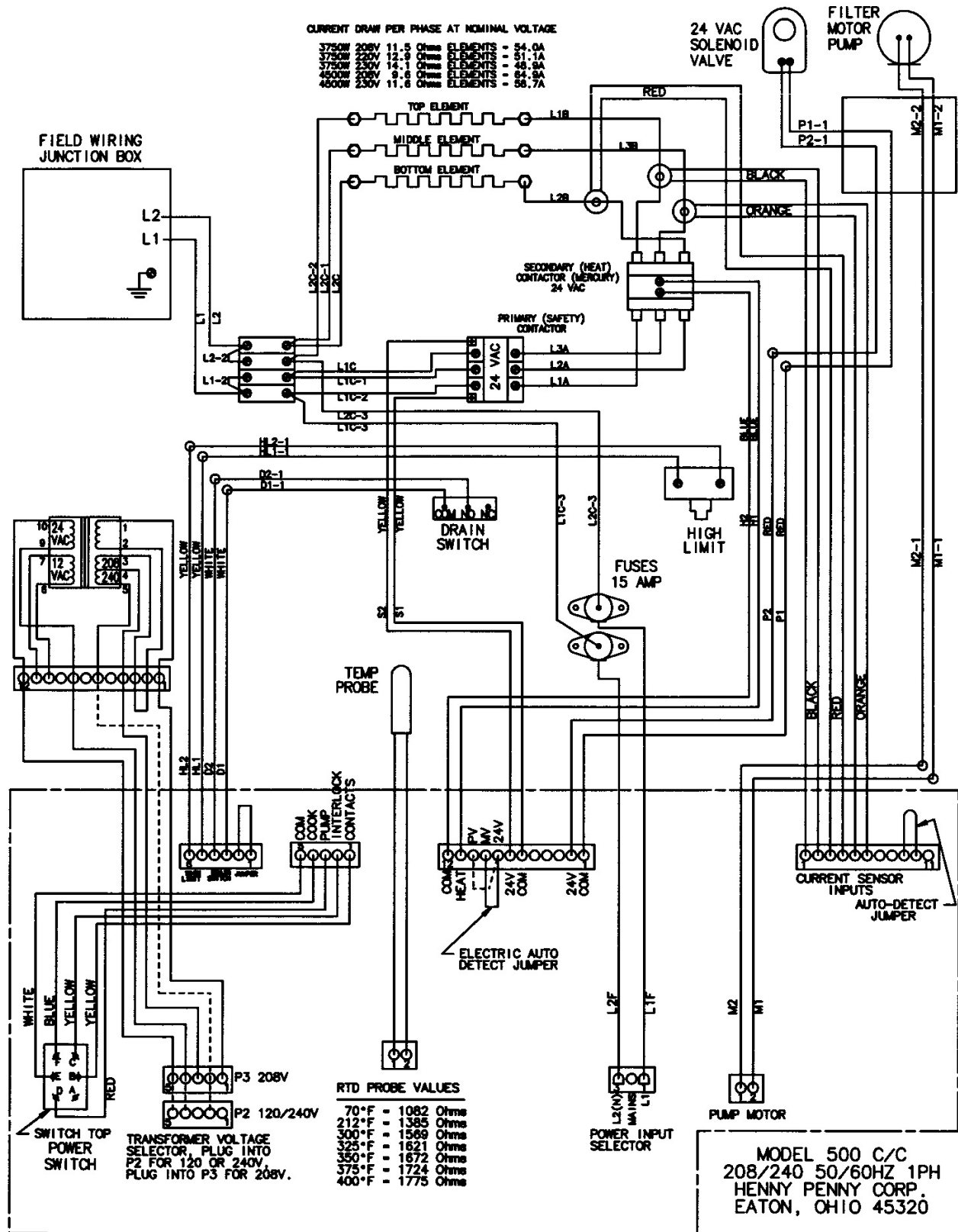

24675



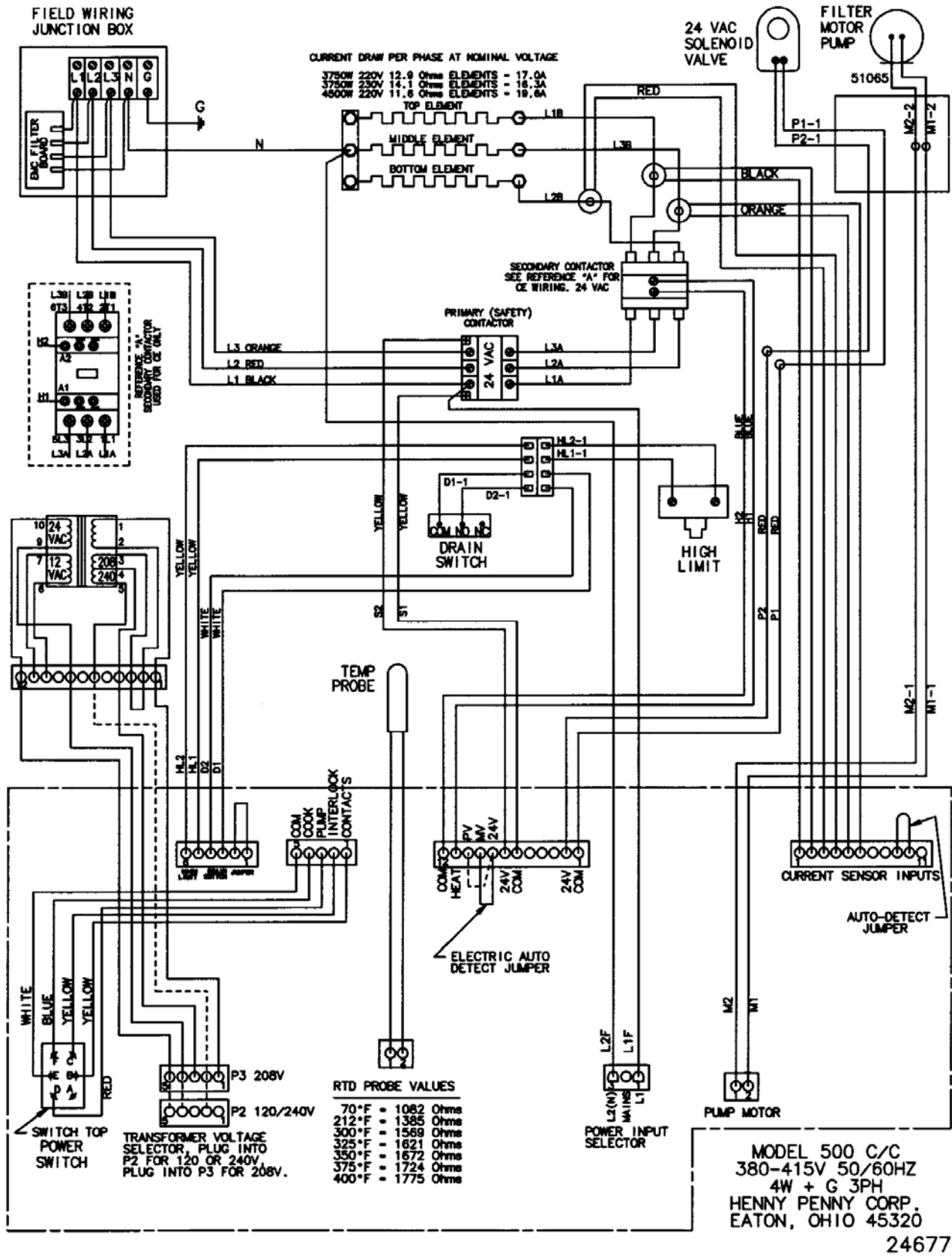

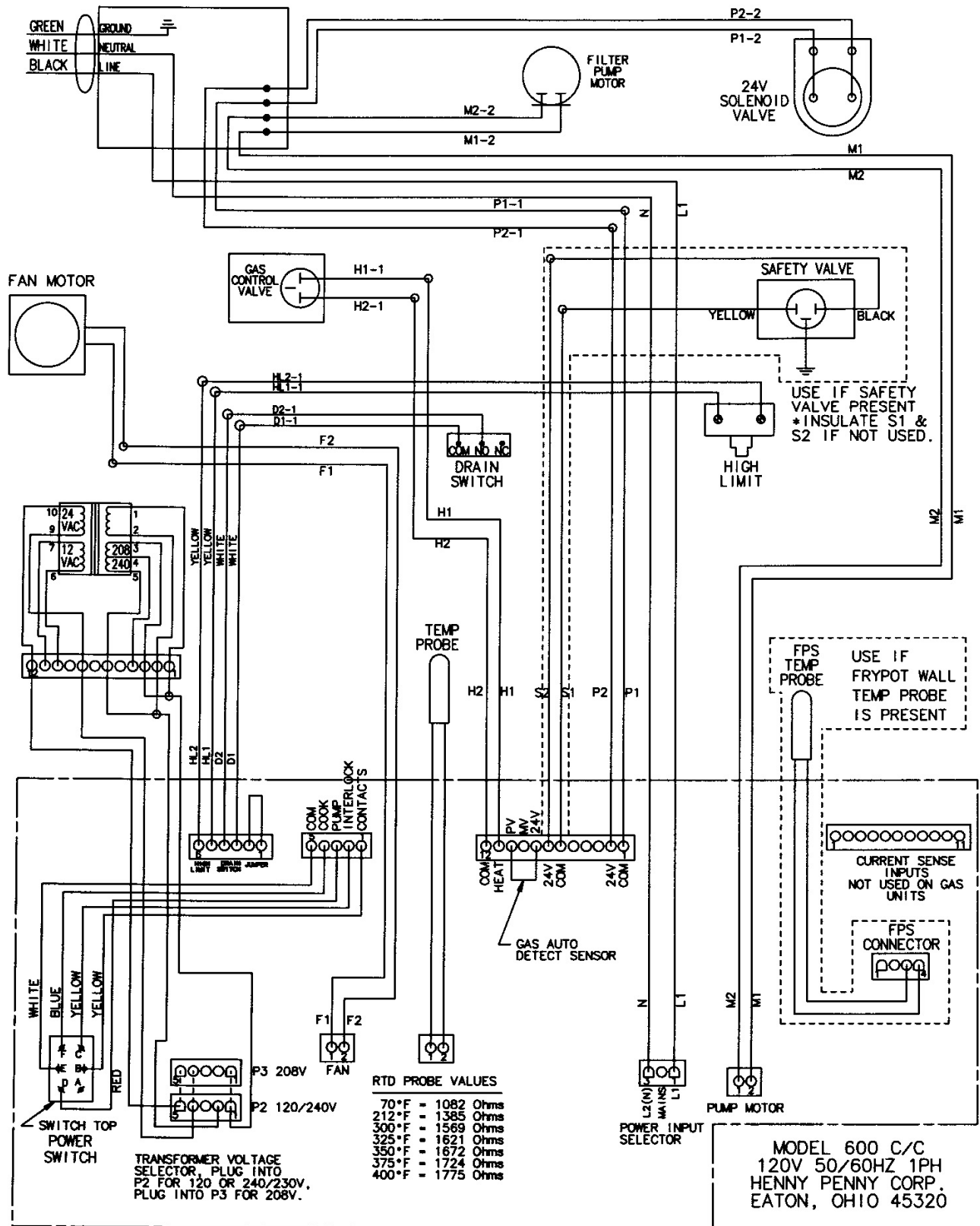

32760

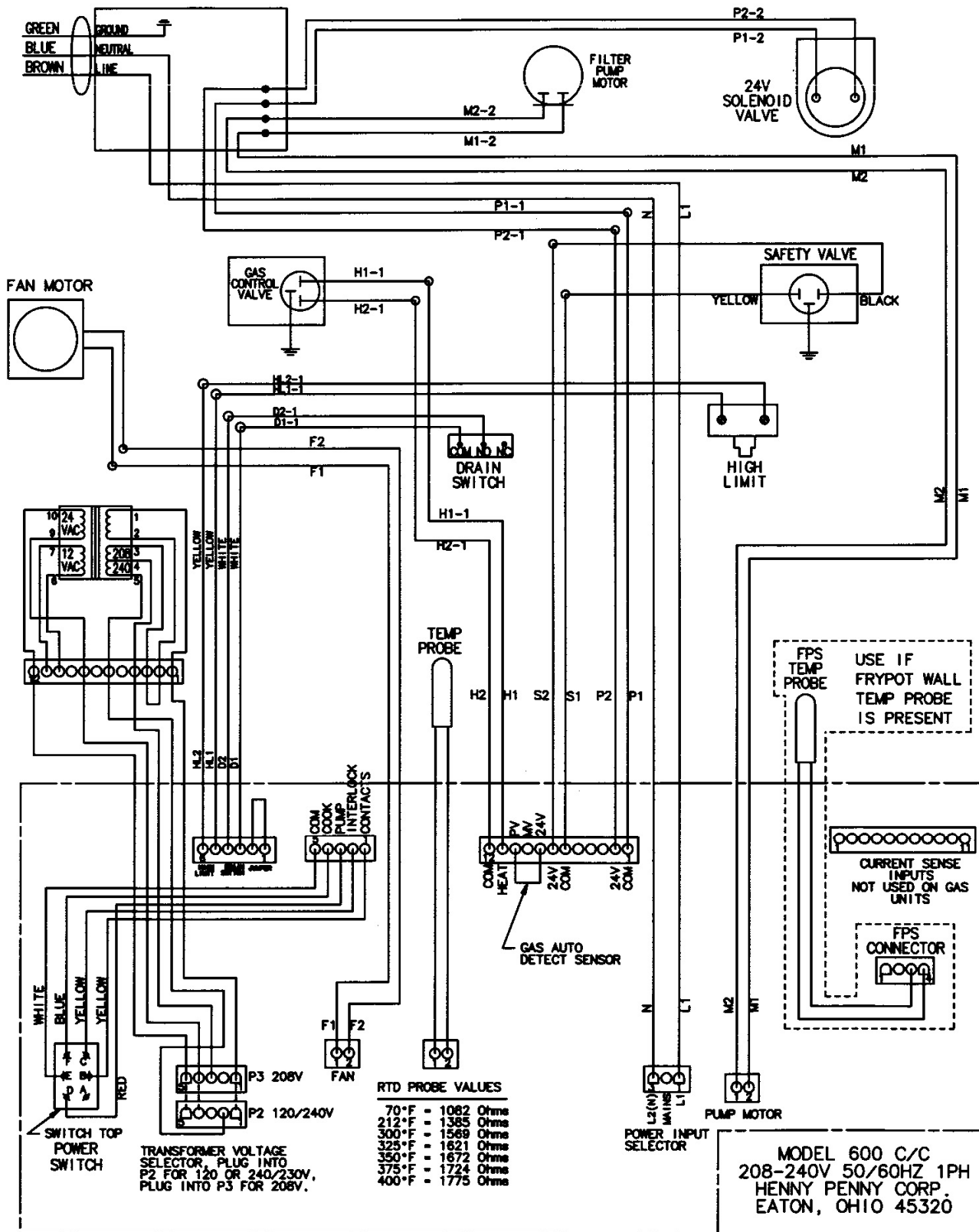

MODEL 600 C/C  
208-240V 50/60HZ 1PH  
HENNY PENNY CORP.  
EATON, OHIO 45320

32759

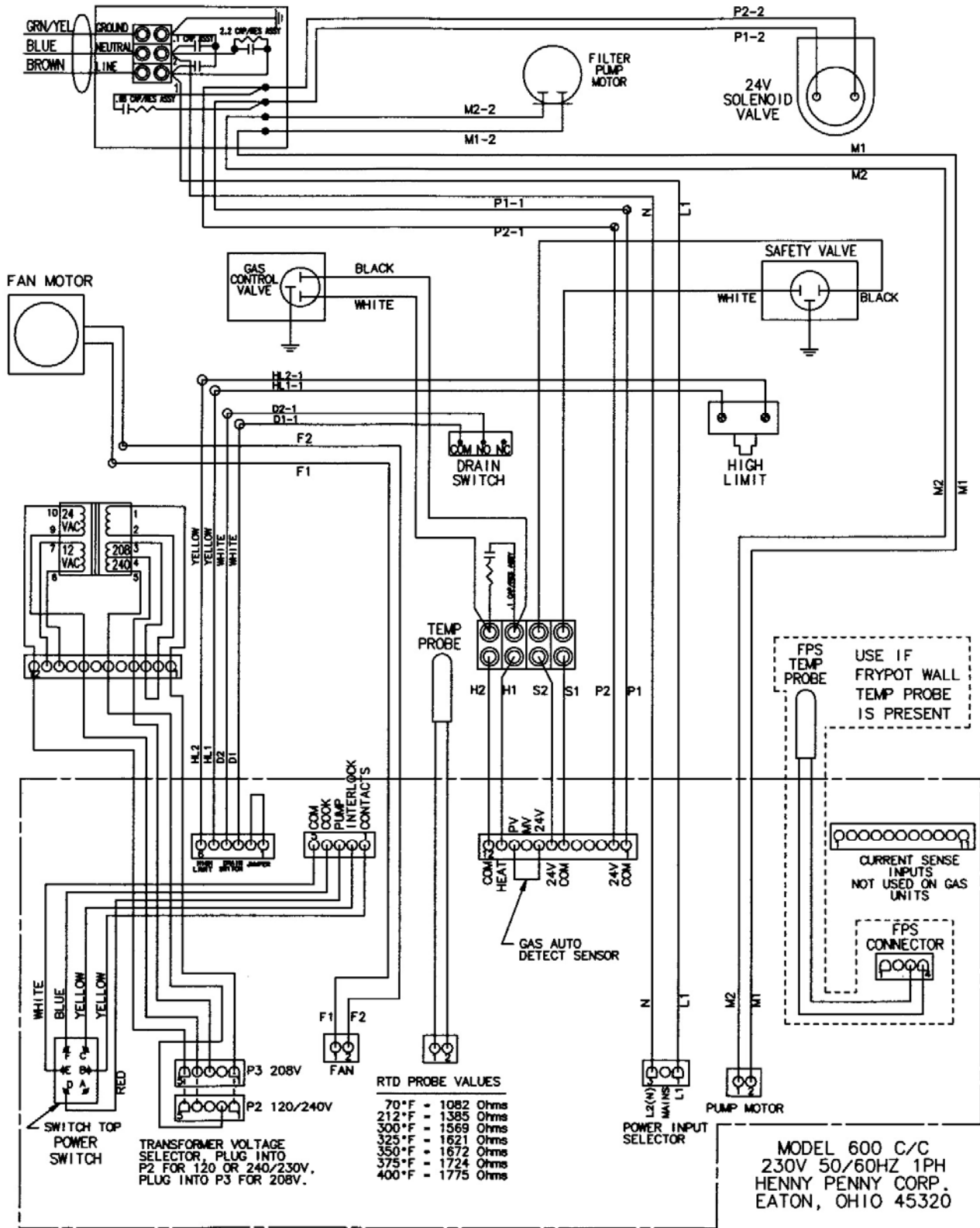

32758



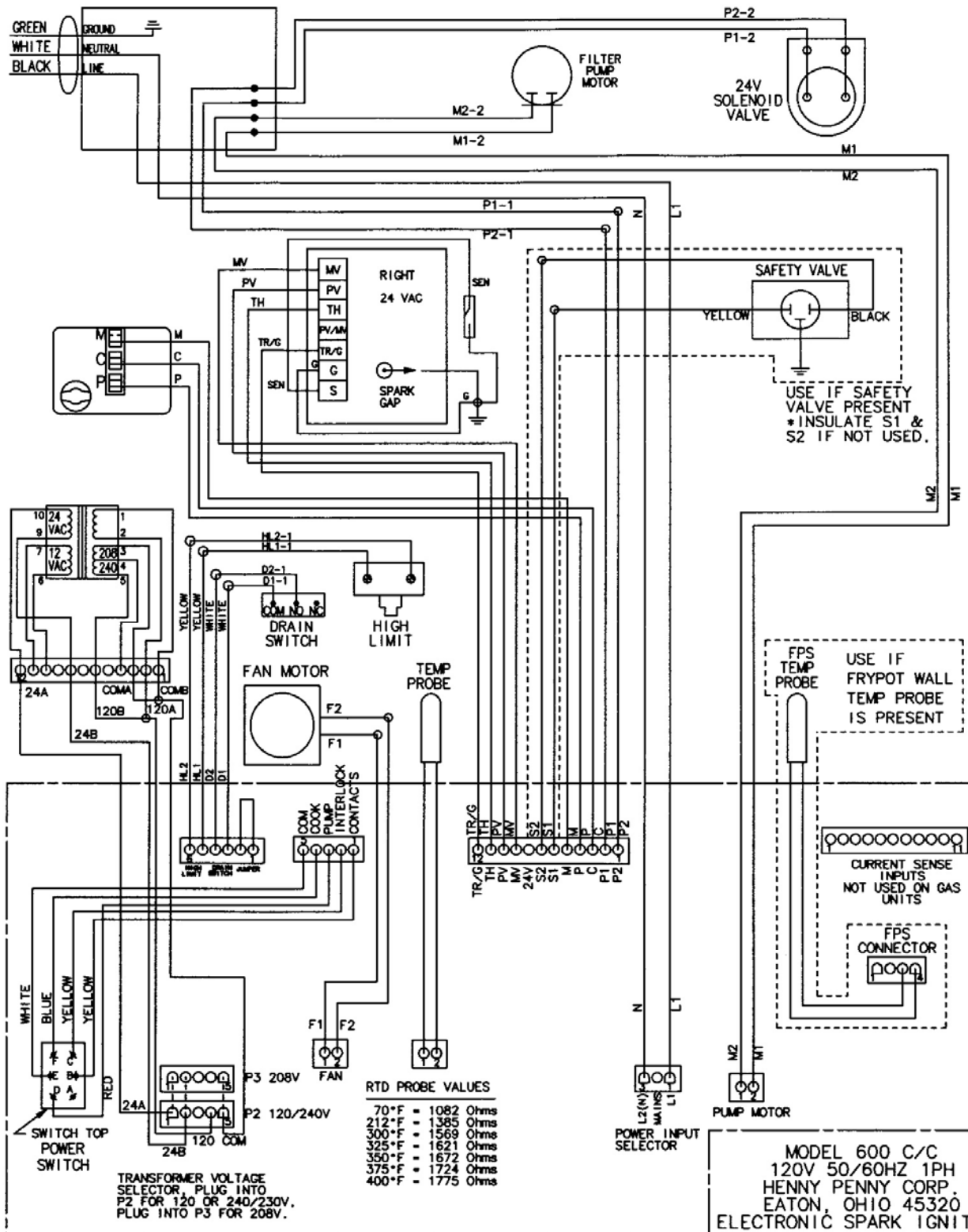

67199

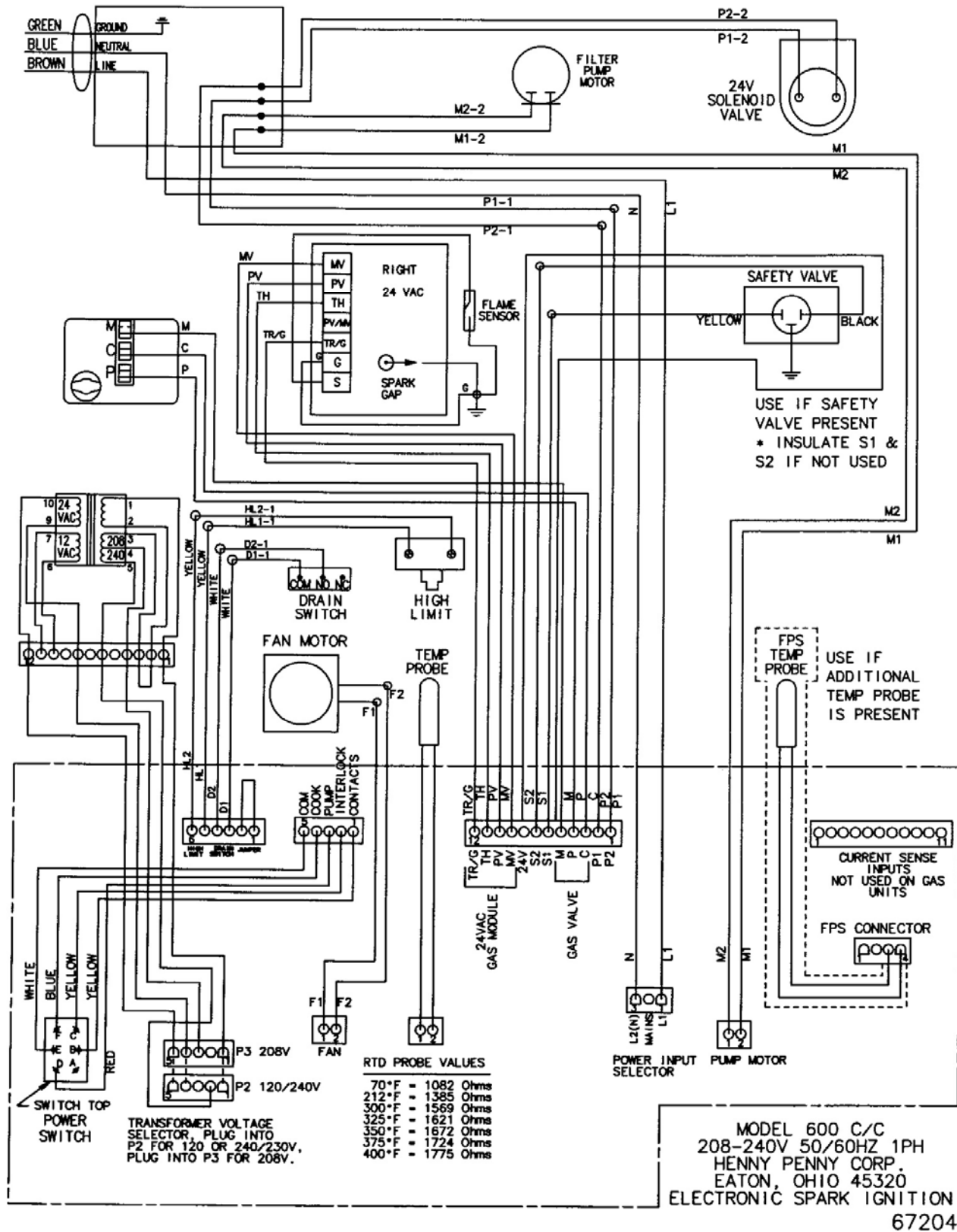

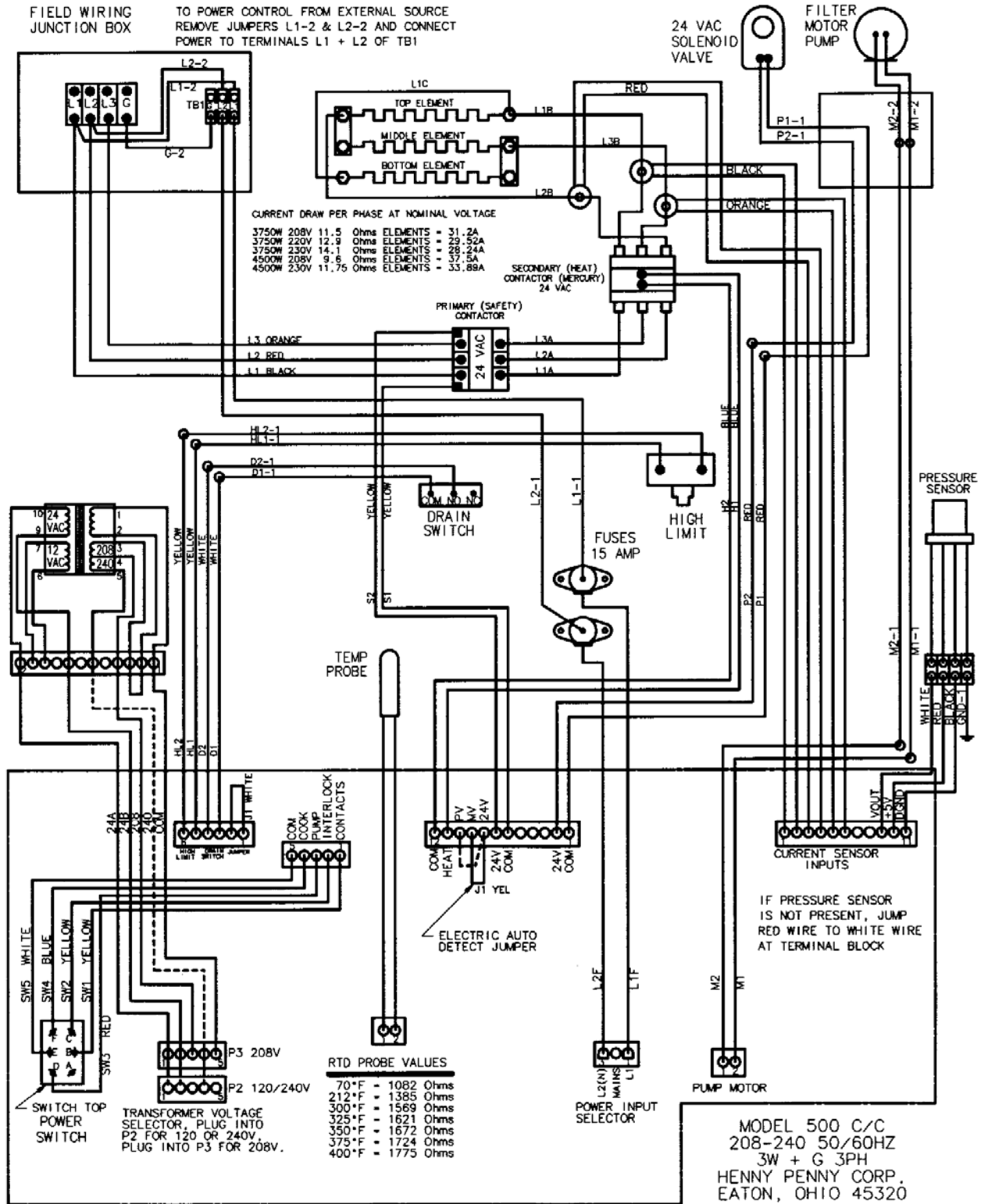

70513

**Express Foods**





**Henny Penny Corporation**  
**P.O.Box 60**  
**Eaton,OH 45320**

**1-937-456-8400**  
**1-937-456-8402 Fax**

**Toll free in USA**  
**1-800-417-8417**  
**1-800-417-8434 Fax**

**\* FM01 - 909 - G \***

Henny Penny Corp., Eaton, Ohio 45320, Revised 01-03-08

**[www.hennypenny.com](http://www.hennypenny.com)**