

SERVICE SINK FAUCET

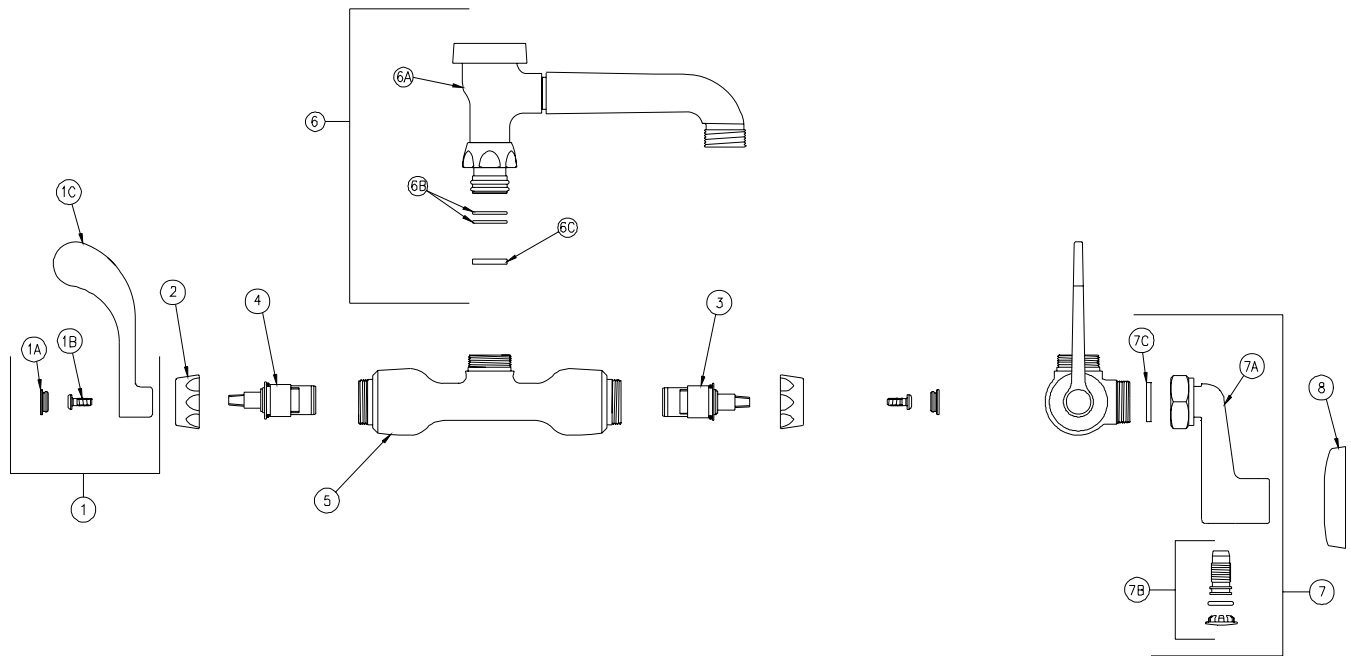

Z841N4 Parts List



Item	Part Number	Description	Qty.
1	G60504	4" [102mm] Vandal-Resistant Metal Wrist Blade Handles	1
1A	G60500	Hot/Cold Color-Coded Indexes	1
	59454001	Hot Index	1
	59454002	Cold Index	1
1B	62464001	10-32 Screw	2
1C	59453001	Wrist Blade Handle	2
2	59523001	Handle Nut	2
3	59517002	Short Hot Cartridge	1
4	59517001	Short Cold Cartridge	1
5	59464001	Body	1
6	G60556	6" Cast Vacuum Breaker 'N' Spout Assembly -PC	1
6A	60864005	6" Vacuum Breaker Spout Sub-Assembly	1
6B	58155018	O-Ring	2
6C	59436001	Spacer Washer	1
7	G60528	Long Supply Arm and Integral Stop Assembly	2
7A	60810003	Long Supply Arm	1
7B	G60527	Screwdriver Integral Stop Assembly	1
	59536001	Stop Plug	1
	58155013	O-Ring	1
	59667001	Hole Plug	1
7C	59748001	Gasket	2
8	G65300	Escutcheon Assembly	2

ZURN INDUSTRIES, INC. ♦ COMMERCIAL BRASS OPERATION ♦ 2640 SOUTH WORK STREET ♦ FALCONER NY 14733

Phone: 1-716-665-1132 ♦ Fax: 1-716-665-1135 ♦ World Wide Web: www.zurn.com

In Canada: ZURN INDUSTRIES LIMITED ♦ 3544 Nashua Drive ♦ Mississauga, Ontario L4V1L2 ♦ Phone: 905/405-8272 Fax: 905/405-1292