

BEVERAGE-AIR

SP/DP/UC/WT
SPD/WTRD/UCRD



PARTS

MANUAL

115V/60HZ & 220V/50HZ

ILLUSTRATIONS 29' BASE REFRIGERATORS
CABINET COMPONENTS

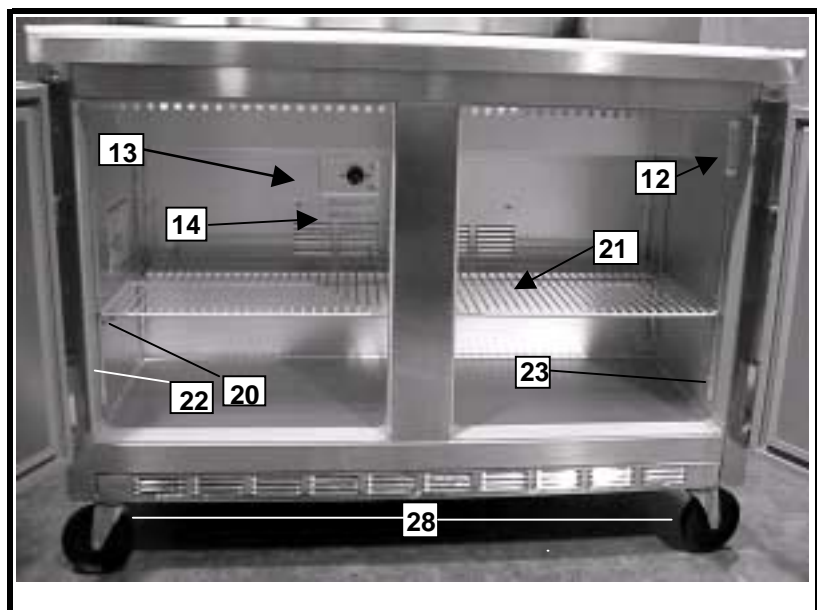
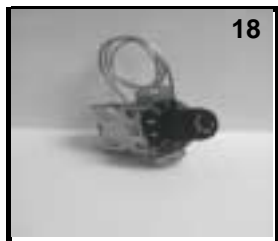
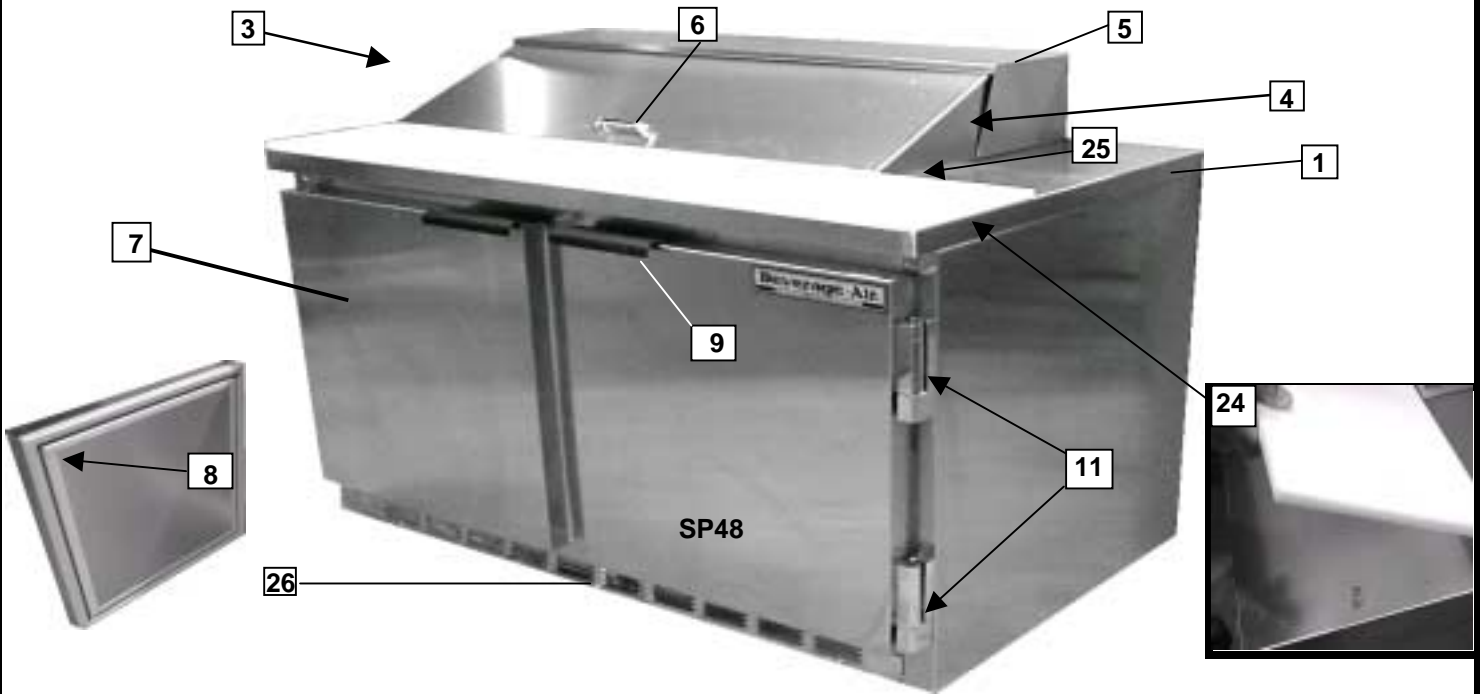
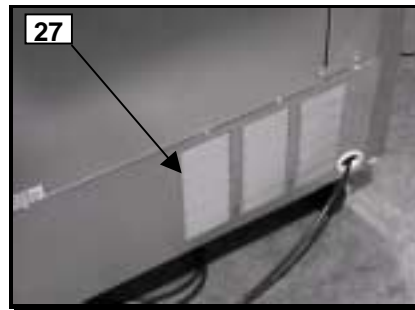
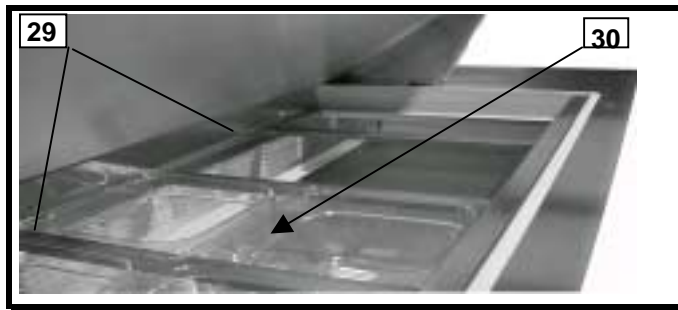

TOP ASSEMBLES

29" BASE REFRIGERATORS

ITEM	MODEL	DESCRIPTION	PART NUMBER
1	SP27/SP27-16	TOP ASSY. COMPLETE	01B35-254C-01
	SP27C	TOP ASSY. COMPLETE	01B35-255C-01
	SP27-12M	TOP ASSY. COMPLETE	01B35-246C-01
	SP48-08	TOP ASSY. COMPLETE	01B35-256D-01
	SP48-08C	TOP ASSY. COMPLETE	01B35-259D-01
	SP48-10	TOP ASSY. COMPLETE	01B35-257D-01
	SP48-10C	TOP ASSY. COMPLETE	01B35-260D-01
	SP48-12	TOP ASSY. COMPLETE	01B35-258D-01
	SP48-12C	TOP ASSY. COMPLETE	01B35-261D-01
	SP48-12M	TOP ASSY. COMPLETE	01B35-262D-01
	SP48-18M	TOP ASSY. COMPLETE	01B35-247D-01
	SP60-08	TOP ASSY. COMPLETE	01B35-263D-01
	SP60-12	TOP ASSY. COMPLETE	01B35-265D-01
	SP60-12M	TOP ASSY. COMPLETE	01B35-271D-01
	SP60-16	TOP ASSY. COMPLETE	01B35-266D-01
	SP60-18M	TOP ASSY. COMPLETE	01B35-272D-01
	SP60-24M	TOP ASSY. COMPLETE	01B35-248D-01
	SP72-08	TOP ASSY. COMPLETE	01B35-273D-01
	SP72-08C	TOP ASSY. COMPLETE	01B35-277D-01
	SP72-10	TOP ASSY. COMPLETE	01B35-274D-01
	SP72-10C	TOP ASSY. COMPLETE	01B35-278D-01
	SP72-12	TOP ASSY. COMPLETE	01B35-275D-01
	SP72-12C	TOP ASSY. COMPLETE	01B35-279D-01
	SP72-12M	TOP ASSY. COMPLETE	01B35-281D-01
	SP72-18	TOP ASSY. COMPLETE	01B35-276D-01
	SP72-18M	TOP ASSY. COMPLETE	01B35-282D-01
	SP72-18C	TOP ASSY. COMPLETE	01B35-280D-01
	SP72-24M	TOP ASSY. COMPLETE	01B35-283D-01
	SP72-30M	TOP ASSY. COMPLETE	01B35-249D-01
	UCR27A	TOP ASSY. COMPLETE	01B35-250C-04
	UCR48A	TOP ASSY. COMPLETE	01B35-251C-04
	UCR60A	TOP ASSY. COMPLETE	01B35-252D-04
	UCR72A	TOP ASSY. COMPLETE	01B35-253D-04
	WTR27A	TOP ASSY. COMPLETE	01B35-284C-04
WTR48A	TOP ASSY. COMPLETE	01B35-285D-04	
WTR60A	TOP ASSY. COMPLETE	01B35-286D-04	
WTR72A	TOP ASSY. COMPLETE	01B35-287D-04	
*2	WTR27-A	SPLASH BOARD	01B36-010B
	WTR48A	SPLASH BOARD	01B36-011B
3	SP27/-16/16C/SPD27	TOP COVER ASSY.	01B36-082A-01
	SP27-12M	TOP COVER ASSY.	01B36-069C-01
	SP48-08/08C	TOP COVER ASSY.	01B36-084A-03
	SP48-10/10C	TOP COVER ASSY.	01B36-084A-02
	SP48-12/12C	TOP COVER ASSY.	01B36-084A-01
	SP48-12M	TOP COVER ASSY.	01B36-074A-02
	SP48-18M	TOP COVER ASSY.	01B36-074A-01
	SP60-08	TOP COVER ASSY.	01B36-084A-03
	SP60-12	TOP COVER ASSY.	01B36-085A-02
	SP60-12M	TOP COVER ASSY.	01B36-073A-01
	SP60-16	TOP COVER ASSY.	01B36-085A-01
	SP60-16 (AFTER #5006876)	(SINGLE) TOP COVER ASSY.	01B36-113A-01
	SP60-18M	TOP COVER ASSY.	01B36-074A-01
	SP60-24M	TOP COVER ASSY.	01B36-075A-01
SP72-08/08C	TOP COVER ASSY.	01B36-085A-04	

* Indicates part not illustrated

1/28/2000

ILLUSTRATIONS 34" BASE REFRIGERATORS
CABINET COMPONENTS

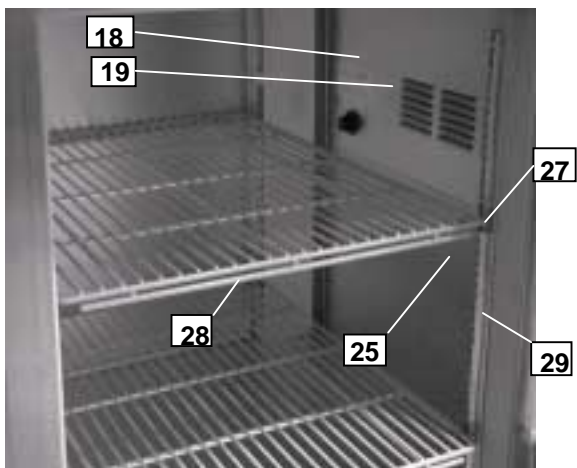
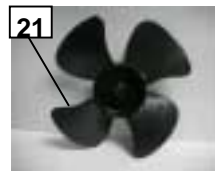
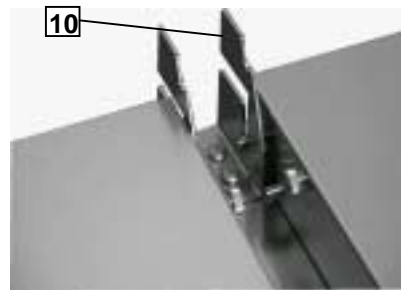

TOP ASSEMBLES
34" BASE REFRIGERATORS

ITEM	MODEL	DESCRIPTION	PART NUMBER
1	DP41	TOP ASSY. COMPLETE	03B01-170D-01
	WTR41	TOP ASSY. COMPLETE	03B01-106D
	UCR41	TOP ASSY. COMPLETE	01B35-184C
	DP46	TOP ASSY. COMPLETE	03B01-179D-01
	WTR46A	TOP ASSY. COMPLETE	03B01-181D-02
	UCR46A	TOP ASSY. COMPLETE	01B35-290C-06
	UCR48A	TOP ASSY. COMPLETE	01B35-251C-04
	WTR48A	TOP ASSY. COMPLETE	04B02-176C-02
	DP67	TOP ASSY. COMPLETE	03B01-172D-01
	WTR67A	TOP ASSY. COMPLETE	04B02-171C-01
	UCR67A	TOP ASSY. COMPLETE	01B35-190C
	DP93	TOP ASSY. COMPLETE	03B01-174D-01
	WTR93A	TOP ASSY. COMPLETE	03B01-108D
	UCR93A	TOP ASSY. COMPLETE	01B35-196C
	DP119	TOP ASSY. COMPLETE	03B01-176D-01
WTR119A	TOP ASSY. COMPLETE	03B01-109D	
UCR119A	TOP ASSY. COMPLETE	01B35-202C	
2	DP41	LID ASSY. (1 NEEDED)	03B04-018D-01
	DP46	LID ASSY.(1 NEEDED)	03B04-024D-01
	DP67	LID ASSY. (SHORT)	03B04-024D-02
		LID ASSY.(LONG)	03B04-024D-03
	DP93	LID ASSY. (LONG) (2 NEEDED)	03B04-024D-03
	DP119	LID ASSY. (LONG) (2 NEEDED)	03B04-024D-03
		LID ASSY.(SHORT) (1 NEEDED)	03B04-024D-04
3	ALL	LID HANDLE	401-201A
	*ALL	LID HANDLE SCREW	603-340A
4	ALL DP	HINGE BRACKET PLATE(RH)	03B03-019B
5	ALL DP	HINGE BRACKET PLATE(LH)	03B03-020B
6	ALL DP	HINGE PIN	604-196A
*7	ALL DP	INSERT #10-32 LOW HEAD	604-161A
8	ALL DP	TOP COVER HINGE (L.H.)	03A07-022C-04
9	ALL DP	TOP COVER HINGE (R.H.)	03A07-021C-04
10	DP67/93/119	TOP COVER HINGE (CENTER)	03A07-023C-04

DOOR ASSEMBLES
34" BASE REFRIGERATORS

ITEM	MODEL	DESCRIPTION	PART NUMBER
11	ALL DP/UC/WT-A	DOOR ASSEMBLY COMPLETE	02B01-257C
12	ALL DP/UC/WT-A	DOOR GASKET (23-1/8X25-1/8)	703-963D-05
13	ALL DP/UC/WT-A	DOOR HANDLE	401-506C
*14	ALL DP/UC/WT-A	DOOR HANDLE SCREWS	603-338A
15	ALL DP/UC/WT-A	DOOR HINGE (TOP/BOTTOM/LH&RH)	401-657B
16	ALL DP/UC/WT-A	HINGE COVER	401-244B
*17	ALL DP/UC/WT-A	HINGE PIVOT CAM (NYLON)	401-242B

ILLUSTRATIONS FOR UNDER COUNTER & WORK TOP FREEZERS
CABINET COMPONENTS



CABINET COMPONENTS UNDER COUNTER & WORK TOP FREEZERS

ITEM	MODEL	DESCRIPTION	PART NUMBER
1	UCF/WTF27A	TOP ASSY. COMPLETE	01B35-284C-04
	UCF/WTF48A	TOP ASSY. COMPLETE	01B35-285D-04
	UCF/WTF67	TOP ASSY. COMPLETE	03B01-107D
2	UCF/WTF27A	SPLASH BOARD ASSY.	01B36-010B
	UCF/WTF48A	SPLASH BOARD ASSY.	01B36-011B

DOOR ASSEMBLES UNDER COUNTER & WORK TOP FREEZERS

ITEM	MODEL	DESCRIPTION	PART NUMBER
3	UCF/WTF27A	D00R ASSEMBLY COMPLETE	02B01-249C
	UCF/WTF48A	D00R ASSEMBLY COMPLETE	02B01-253C
	UCF/WTF67	D00R ASSEMBLY COMPLETE	02B01-257C
4	UCF/WTF27A	DOOR GASKET (23-18X24-1/2)	703-963D-02
	UCF/WTF48A	DOOR GASKET (21-1/16X23-1/8)	703-963D-03
	UCF/WTF67	DOOR GASKET (23-1/8X25-1/8)	703-963D-05
5	UCF/WTF27/48A	DOOR HANDLE	401-506C
*6	UCF/WTF27/48A	DOOR HANDLE SCREWS	603-338A
7	UCF/WTF27/48A	DOOR HINGE (TOP/BOTTOM/LH&RH)	401-657B
8	UCF/WTF27/48A	HINGE COVER	401-244B
*9	UCF/WTF27/48A	HINGE PIVOT CAM (NYLON)	401-242B
*10	UCF/WTF27/48A	THERMOMETER	402-233B
*11	UCF/WTF27A&67	FACE HEATER	504-247B
	UCF/WTF48A	FACE HEATER	504-248B

EVAPORATOR HOUSINGS UNDER COUNTER & WORK TOP FREEZERS

ITEM	MODEL	DESCRIPTION	PART NUMBER
12	UCF/WTF27/48A	EVAP. HOUSING ASSY.	04B01-076D-02
	UCF/WTF27/48A	EVAP HSG. ONLY	04A02-356D-09
*13	UCF/WTF67	EVAP.FAN MOUNT ASSY.	04B04-036C
14	UCF/WTF67	EVAP.FRT.COVER ASSY.	04B04-043C
	UCF/WTF27/48A	EVAP.FRT.COVER ASSY.	04B02-175D-04
15	ALL UCF/WTF	EVAP. TOP COVER	28D47-040D-10
Note: UCF/WTF/27/48A units have the evaporator pans incorporated into the cabinet and are not replaceable. After serial number 5100521			
*16	UCF/WTF67	PAN ASSY - EVAP	04B02-171C-01
17	UCF/WTF27/48A	DEFROST TIMER	502-171A
	UCF/WTF67	DEFROST TIMER	502-233A
18	UCF/WTF27/48A	TEMP. CONTROL	502-111A
	UCF/WTF67	TEMP. CONTROL	502-150A
19	ALL UCF/WTF	EVAPORATOR MOTOR	501-105B
20	ALL UCF/WTF	EVAPORATOR MOTOR BLADE	405-063A

ILLUSTRATIONS SPD/UCRD/WTRD/UCR UNITS
CABINET COMPONENTS

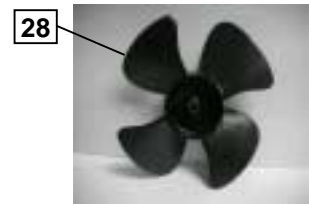
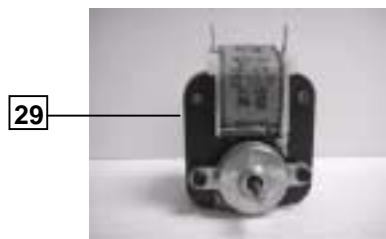
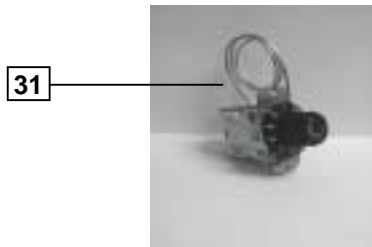
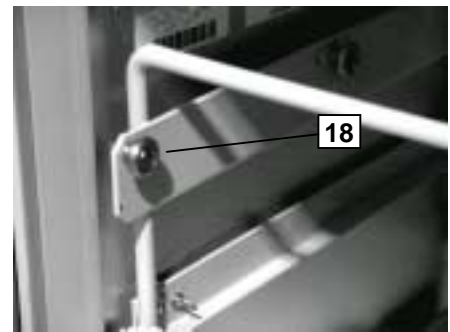
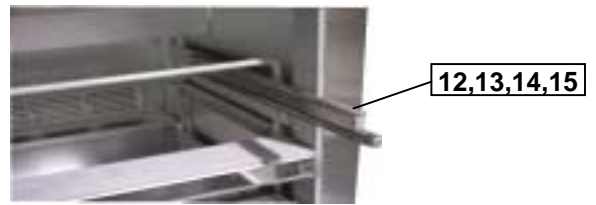
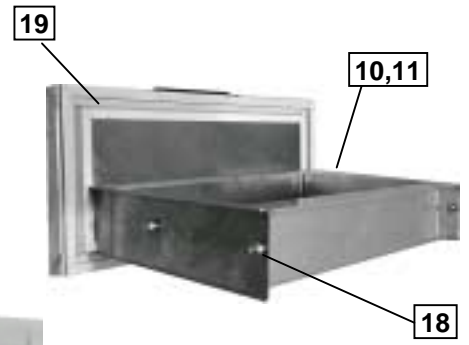
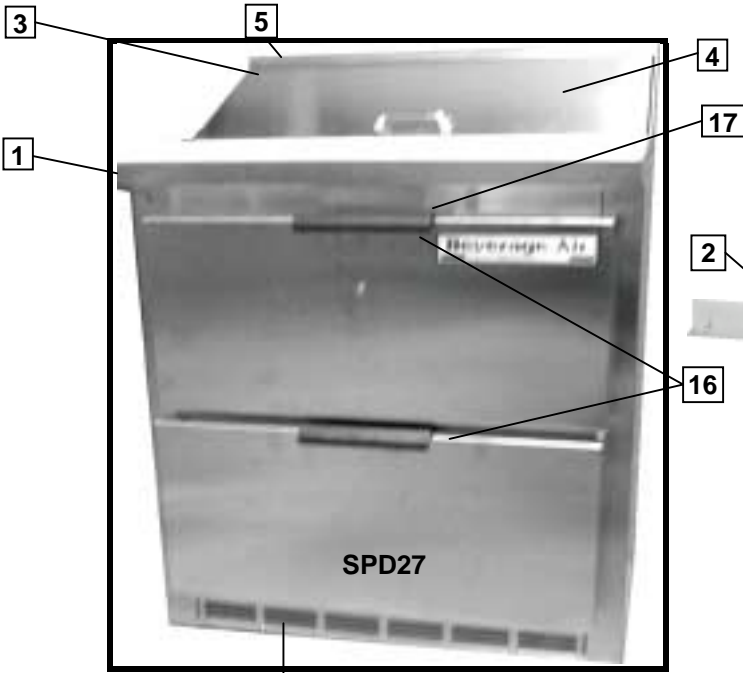
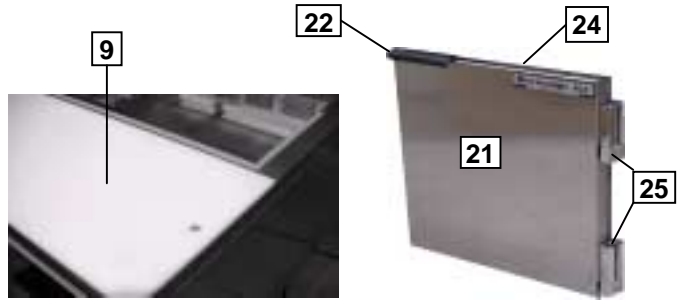
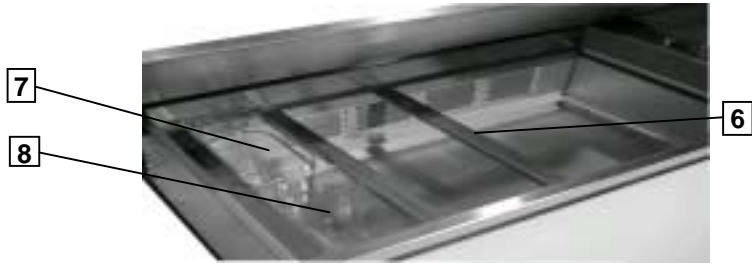

**TOP ASSEMBLES
SPD/UCRD/WTRD27/UCR20/34**

ITEM	MODEL	DESCRIPTION	PART NUMBER
1	SPD27	TOP ASSY. COMPLETE	01B35-254C-01
	UCRD27-A	TOP ASSY. COMPLETE	01B35-250C-04
	WTRD27-A	TOP ASSY. COMPLETE	01B35-284C-04
	UCR20	TOP ASSY. COMPLETE	01B35-237C-06
	UCR34	TOP ASSY. COMPLETE	01B35-214C
2	WTRD27-A	SPLASH BOARD	01B36-010B
3	SPD27	TOP COVER ASSY.	01B36-082A-01
4	SPD27	TOP COVER (LID)	01B40-002D-01
5	SPD27	SERVING BAR (LID HOUSING)	01B36-093C-01
6	SPD27	PAN SUPPORTS (3 NEEDED)	28D40-056C-05
7	SPD27	PAN 1/6 4 DEEP PLASTIC	403-490C
8		PAN 1/9 4 DEEP PLASTIC	403-493C
9	SPD27	CUTTING BOARD (10")	705-290C-01

**DRAWER ASSEMBLES
SPD/UCRD/WTRD27 ONLY**

ITEM	MODEL	DESCRIPTION	PART NUMBER
10	SPD27/UCRD WTRD27-A	DRAWER ASSY -COMP TOP	00B27-089D-02
11	SPD27/UCRD WTRD27-A	DRAWER ASSY -COMP BOT	00B27-088D-02
12	SPD27/UCRD WTRD27-A	RAIL ASSY - SLIDE LH	00B27-072C-01
13	SPD27/UCRD WTRD27-A	RAIL ASSY - SLIDE RH	00B27-072C-02
14	SPD27/UCRD WTRD27-A	SLIDE RAIL ASSY-BOT LH	00B27-086C-01
15	SPD27/UCRD WTRD27-A	SLIDE RAIL ASSY-BOT RH	00B27-086C-02
16	SPD27/UCRD WTRD27-A	DRAWER HANDLE	401-506C
17	SPD27/UCRD WTRD27-A	DRAWER HANDLE SCREWS	603-408A
18	SPD27/UCRD WTRD27-A	DRAWER ROLLERS	403-513A
19	SPD27/UCRD WTRD27-A	DRAWER GASKET	703-963D-15
20	SPD27/UCRD WTRD27-A	PAN SUPPORTS FOR DRAWERS	00A27-057B-04

220V/50HZ SECTION COMPRESSORS

ITEM	MODEL	DESCRIPTION	PART NUMBER
1	SP27/UCR WTR27-A DP/UCR/WTR46/67-A SPD/UCRD/WTRD27 UCR20	COMPRESSOR 1/6HP 220-50 SIC AZ0370Y	302-952B
	SP48/UCR48 WTR48-A DP/UCR/WTR93/119-A UCR34	COMPRESSOR 1/5HP 220-50 SIC AZA0395YXC	302-828B
	SP60/UCR60A WTR60A SP72/UCR72 WTR72A	COMPRESSOR 1/4HP 220-50 SIC AEA3430YXC	302-648B
	UCF/WTF27/48-A	COMPRESSOR 1/4HP 220-50 TEC AE2380Z	302-946B

OVERLOADS

ITEM	MODEL	DESCRIPTION	PART NUMBER
2	SP27/UCR WTR27-A DP/UCR/WTR46/67-A SPD/UCRD/WTRD27 UCR20	(TI) 4TM232NFBYY-53	302-971A
	SP48/UCR48 WTR48-A DP/UCR/WTR93/119-A UCR34	(TI)4TM739JDBYY-51	302-941A
	SP60/UCR60A WTR60A SP72/UCR72 WTR72A	(TI) MRP 59 AMK-69	302-838A
	UCF/WTF27/48-A	(TI)MRP61AMN-69	313-002A

RELAYS

ITEM	MODEL	DESCRIPTION	PART NUMBER
3	SP27/UCR WTR27-A DP/UCR/WTR46/67-A SPD/UCRD/WTRD27 UCR20	(TI) 8EA203	302-972A
	SP48/UCR48 WTR48-A DP/UCR/WTR93/119-A UCR34	(TI)8EA203	302-940A
	SP60/UCR60A WTR60A SP72/UCR72 WTR72A	(TEC)8200EMBE64	314-010A
	UCF/WTF27/48-A	(TEC)8200EMBJ49	314-001A

START CAPACITORS

ITEM	MODEL	DESCRIPTION	PART NUMBER
4	UCF/WTF27/48-A	START CAP (TEC)855S220C66	315-002A
	UCF/WTF27/48-A	CAP/RELAY ASSY	317-002A

EVAPORATOR FAN MOTORS

ITEM	MODEL	DESCRIPTION	PART NUMBER
5	ALL	.40 AMPS 220-50	501-087B

CONDENSER FAN MOTORS

ITEM	MODEL	DESCRIPTION	PART NUMBER
6	ALL	5 WATTS 230-50/60	501-055B

Note* All other parts will be the same as standard units located in the first portion of this manual.

DOOR ASSEMBLES UCR20/34 ONLY

ITEM	MODEL	DESCRIPTION	PART NUMBER
21	UCR20	DOOR ASSY.COMP.	02B01-241C
	UCR34	DOOR ASSY.COMP.	02B01-245C
22	UCR20/34	DOOR HANDLE	401-506C
23	UCR20/34	DOOR HANDLE SCREWS	603-364A
24	UCR20	DOOR GASKET	703-963D-11
	UCR34	DOOR GASKET	703-963D-01
25	UCR20/34	DOOR HINGE (TOP & BOTTOM)	401-657B

EVAPORATOR ASSEMBLES SPD/UCRD/WTRD27/UCR20/34

ITEM	MODEL	DESCRIPTION	PART NUMBER
26	SPD27/UCRD WTRD27-A	HSG ASSY-EVAP	04B01-076D-02
	UCR20	HSG ASSY-EVAP	04B01-056D
	UCR34	HSG ASSY-EVAP	04B01-066D-02
27	SPD27/UCRD WTRD27-A	COVER ASSY - EVAP	04B02-175D-02
	UCR20	EVAP.HSG.FRT.GRL.ASSY	04B02-102C
	UCR34	EVAP.FRT.GRILLE ASSY	04B02-091C
28	SPD27/UCRD WTRD27-A UCR20/34	EVAP. FAN BLADE	405-063A
29	SPD27/UCRD WTRD27-A UCR20/34	EVAP. FAN MOTOR	501-105B
30	ALL	EVAP. MOTOR BRCKET	42A37P011B
31	SPD27/UCRD WTRD27-A	TEMP. CONTROL	502-269A
	UCR20	TEMP. CONTROL	502-205A
	UCR34	TEMP. CONTROL	502-236A
32	SPD27/UCRD WTRD27	EVAPORATOR PANS ARE INCORPORATED INTO THE CABINET & ARE NOT REPLACEABLE AFTER SERIAL #5100521	NA
	UCR20	EVAP. DRAIN PAN	04B02-101C
	UCR34	EVAP. DRAIN PAN	04B02-090C
33	ALL	THERMOMETER - HORIZ PUSH-IN	402-223B

SHELVES UCR20/34 ONLY

ITEM	MODEL	DESCRIPTION	PART NUMBER
34	UCR20	SHELF 12.13X15.3812.13X15.38	403-419D
	UCR24	SHELF 11X29.38	403-339D
35	UCR20/34	SHELF CLIPS	403-169A
36	UCR20/34	PILASTER 27/48 15"	403-154A
37	UCR20/34	PILASTER 10"	403-307A
38	ALL	CASTER KIT	00C31-038A

GRILLS SPD/UCRD/WTRD27/UCR20/34

ITEM	MODEL	DESCRIPTION	PART NUMBER
39	SPD27/UCRD WTRD27-A	GRILLE ASSY -FRONT	07B31-061B
	UCR20	GRILLE ASSY -FRONT	07B31-062C
	UCR34	GRILLE ASSY -FRONT	07B31-051C
40	SPD27/UCRD WTRD27-A	GRILLE - REAR	28D37-090D-03
	UCR20	GRILLE - REAR	28D37-054D
	UCR34	GRILLE - REAR	28D37-052D

REFRIGERATION

SPD/UCRD/WTRD27UCR20/34

ITEM	MODEL	DESCRIPTION	PART NUMBER
1	SPD27/UCRD WTRD27	REFRIGERATION ASSEMBLY	19B36-086D-01
	UCR20	REFRIGERATION ASSEMBLY	19C30-091C
	UCR34	REFRIGERATION ASSEMBLY	19C30-089C
2	SPD27/UCRD WTRD27	CONDENSING UNIT	15B33-045C
	UCR20	CONDENSING UNIT	15B33-063C
	UCR34	CONDENSING UNIT	15B33-061C
3	SPD27/UCRD WTRD27/UCR20	COMPRESSOR (1/6HP) (AZA0370YXA)	302-687B
	UCR34	COMPRESSOR (1/5HP) (AZA0395YXA)	302-676B
4	SPD27/UCRD WTRD27/UCR20	OVERLOAD	302-688A
	UCR34	OVERLOAD	302-918A
5	SPD27/UCRD WTRD27/UCR20	RELAY	302-702A
	UCR34	RELAY	302-677A
6	UCR34	START CAPACITOR	302-919A
7	ALL	DRYER	303-143A
8	SPD27/UCRD WTRD27-A/UCR34	CONDENSER COIL(5-5/16X7-7/8X3)	305-144C
	UCR20	CONDENSER COIL(5-1/8X8X2)	305-204C
9	SPD27/UCRD WTRD27A UCR20/34	CONDENSER FAN MOTOR (5 WATTS)	501-019B
10	SPD27/UCRD WTRD27	CONDENSER FAN BLADE(6.75") (3 PED ALUM)	405-015A--
	UCR20/34	CONDENSER FAN BLADE	405-058A
11	SPD27/UCRD WTRD27-A	EVAPORATOR COIL ASSY.	19B31-021D
	UCR20	EVAPORATOR COIL ASSY.	20B30-088D
	UCR34	EVAPORATOR COIL ASSY.	20B30-083D
12	SPD27/UCRD WTRD27-A	EVAP COIL (20X4X3)	305-175C
	UCR20	EVAP COIL (10X4X3)	305-202C
	UCR34	EVAP COIL (20X4X3)	305-209C

* Indicates part not illustrated

03/27/2000

REFRIGERATION (CONTINUED)

SPD/UCRD/WTRD27

UCR20/34

ITEM	MODEL	DESCRIPTION	PART NUMBER
13	UCR20	SUC/CAP ASSY	20B35-077D
	UCR34	SUC/CAP ASSY	20B35-075D
14	SPD27/UCRD WTRD27-A/UCR34	CAP TUBE .036ID X .087OD X 120	203-048A--
	UCR20	CAP TUBE .031ID X .081OD X 48	203-129A
15	SPD27/UCRD WTRD27-A	ACCUMULATOR	303-071A
	UCR20/34	ACCUMULATOR	303-094A
16	SPD27/UCRD WTRD27-A	REFRIGERANT	0.4375
	UCR20	REFRIGERANT	0.3125
	UCR34	REFRIGERANT	0.28125
17	SPD27	WIRING DIAGRAM	*IL-1792B
	UCRD/WTRD27-A	WIRING DIAGRAM	*IL-1811D
	UCR20/34	WIRING DIAGRAM	*ILB-1351
18	SPD27	WIRE HARNESS	504-762C
	UCRD/WTRD27A UCR20/34	WIRE HARNESS	504-430C
19	SPD27	CONDENSATE PAN	08B30-041D-01
	UCRD/WTRD27-A	CONDENSATE PAN	706-047C
	UCR20	CONDENSATE PAN	30D02-014C
	UCR34	CONDENSATE PAN	30D02-013C

REFRIGERATION ASSEMBLY COMPONENTS
(REFRIGERATORS)

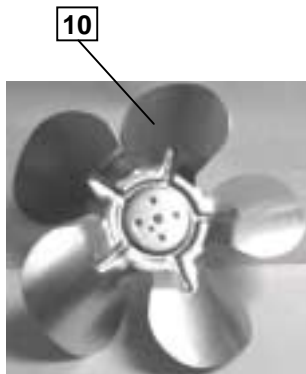
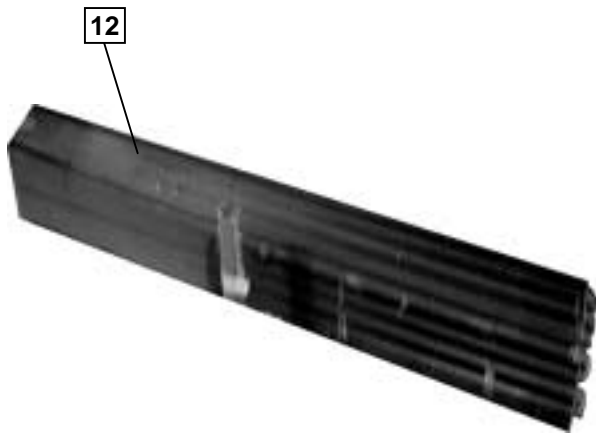

**SHELVES & GRILLS
UNDER COUNTER & WORK TOP FREEZERS**

ITEM	MODEL	DESCRIPTION	PART NUMBER
21	UCF/WTF27A	22.25X15.5	403-294D
	UCF/WTF48A	20.88X14.5	403-293D
	UCF/WTF67	20.82X26	403-507D
22	ALL UCF/WTF	SHELF CLIPS	403-169A
23	UCF/WTF27/48A	15"	403-154A
	UCF/WTF67	21"	403-514B
24	UCF/WTF24/48A	FRONT GRILL	07B31-061B
	UCF/WTF67	FRONT GRILL	28D37-033C
*25	UCF/WTF27/48A	REAR GRILL	28D37-088D-03
26	UCF/WTF27/48A	CASTER KIT	00C31-038A
	UCF/WTF67	CASTER KIT	29B02-015A

REFRIGERATION UNDER COUNTER & WORK TOP FREEZERS

ITEM	MODEL	DESCRIPTION	PART NUMBER
*1	UCF/WTF27/48A	REFRIGERATION ASSEMBLY	19B36-082D-01
	UCF/WTF67	REFRIGERATION ASSEMBLY	19B36-059D
2	UCF/WTF27/48A	CONDENSING UNIT	19B34-037D-01
	UCF/WTF67	CONDENSING UNIT	15B01-052D
3	UCF/WTF27/48A	COMPRESSOR(1/4HP 115-60 AEA2380ZXA)	302-924B
	UCF/WTF67	COMPRESSOR(3/4HP 115-60 RS64CIE-CAA)	302-881B
4	UCF/WTF27/48A	OVERLOAD (TI)MRP30AGK-69)	313-003A
	UCF/WTF67	OVERLOAD (071-0127-43)	302-882A
5	UCF/WTF27/48A	RELAY (3ARR12-KPL226)	314-002A
	UCF/WTF67	RELAY (040-0001-38)	302-883A
6	UCF/WTF27/48A	START CAP.(243-292 MFD @ 110V)	302-993A
	UCF/WTF67	START CAP.(81-90 MFD @ 320V)	302-885A
	UCF/WTF67	RUN CAP.(30MFD @ 440V)	302-884A
	UCF/WTF67	RUN CAP. ASSY.(514-1207-48)	302-886A
7	ALL UCF/WTF	DRYER	303-143A
8	UCF/WTF27/48A	CONDENSER COIL (6X8.13X3.5)	305-362C
	UCF/WTF67	CONDENSER COIL (11X10-7/8X4)	305-160C
9	UCF/WTF27A	CONDENSER FAN MOTOR (5 WATTS)	501-019B
	UCF/WTF48A&67	CONDENSER FAN MOTOR (9 WATTS)	501-148B
10	UCF/WTF27A	CONDENSER FAN BLADE	405-015A--
	UCF/WTF48A	CONDENSER FAN BLADE	405-050A
	UCF/WTF67	CONDENSER FAN BLADE	405-066B
*11	UCF/WTF27/48A	EVAP. COIL ASSY.	19B31-008D-01
	UCF/WTF67	EVAP. COIL ASSY.	20B30-102D
12	UCF/WTF27/48A	EVAP. COIL ONLY.(20X4X4)	305-176C
	UCF/WTF67	EVAP. COIL ONLY.(20X7X4)	305-222C
*13	UCF/WTF27/48A	SUCTION LINE AND CAP. ASSY.	19B30-025D
	UCF/WTF67	SUCTION LINE AND CAP. ASSY.	20B35-093D
14	UCF/WTF27/48A	CAP. TUBE .036IDX.087ODX84	203-126A
	UCF/WTF67	CAP. TUBE .042ID X .093OD X 68	203-109A
*15	ALL	ACCUMULATOR	303-071A
*16	UCF/WTF27/48A	REFRIGERANT .37500 LBS	R404A
	UCF/WTF67	REFRIGERANT .96900 LBS	R404A
*17	UCF/WTF27/48A	WIRING DIAGRAM	*ILA-0886
	UCF/WTF67	WIRING DIAGRAM	*ILB-1488
*18	WTF27	WIRING HARNESS	504-787C
	WTF48	WIRING HARNESS	504-291C
	UCF/WTF67	WIRING HARNESS	504-291C
*19	UCF/WTF27/48A	CONDENSATE PAN	706-047C
	UCF/WTF67	CONDENSATE PAN	43B35-012C
20	UCF/WTF27/48A	DEFROST HEATER	504-454B
	UCF/WTF67	DEFROST HEATER	504-465B
	ALL UCF/WTF	DEFROST LIMIT SWITCH	502-089A

*Indicates parts not illustrated

3/01/2000

REFRIGERATION ASSEMBLY COMPONENTS
(FREEZERS)

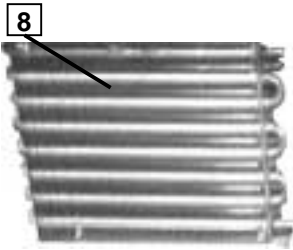

EVAPORATOR HOUSINGS 34" BASE REFRIGERATORS

ITEM	MODEL	DESCRIPTION	PART NUMBER
18	UCR/WTR27/48A	EVAP. HOUSING	04B01-076D-02
19	ALL DP	EVAP. FAN COVER	04B04-050C
	UCR/WTR27A	EVAP. FAN COVER	04B02-175D-02
	UCR/WTR46/67/93/119A	EVAP. FAN COVER	04B04-043C
	UCR/WTR48A	EVAP. FAN COVER	04B02-176C-02
*20	ALL DP	EVAP. FAN MOUNT ASSY.	04B04-055C-02
	WTR46/67A	EVAP. FAN MOUNT ASSY.	04B04-016C
	UCR/WTR93/119A	EVAP. FAN MOUNT ASSY.	04B04-018C
21	UCR/UTR41/46/48/93/119-A ALL DP	EVAP.FAN BLADE (6" WHITE)	405-062A
	UCR/WTR27A	EVAP.FAN BLADE (6"BLACK)	405-063A
22	ALL DP/UCR/WTR	EVAP. MOTOR	501-105B
*23	ALL DP/UCR/WTR	EVAP. MOTOR BRACKET	42A37-011B
24	ALL DP	TEMP. CONT	502-140A
	UCR/WTR27A	TEMP. CONT	502-269A
	UCR/WTR41-46/48/67/93/119A	TEMP. CONT	502-290B
25	ALL DP	EVAP. DRAIN PAN ASSY.	04B02-060C
	UCR/WTR41-46/67/93/119A	EVAP. DRAIN PAN ASSY.	04B02-171C-01
*26	ALL DP	THERMOMETER	401-236B

SHELVES, CUTTING BOARDS & GRILLS 34" BASE REFRIGERATORS

ITEM	MODEL	DESCRIPTION	PART NUMBER
27	ALL DP/WT/UC-A	SHELF SUPPORT	403-169A
28	ALL DP/WT/UC-A	SHELF (20.82X36)	403-507D
29	ALL DP/WT/UC-A	PILASTER (21")	403-514B
30	DP41	CUTTING BOARD (19X41)	705-285B
	DP46	CUTTING BOARD (19X46)	705-307C-01
	DP67	CUTTING BOARD (19X67)	705-286B
	DP93	CUTTING BOARD (19X93)	705-287B
	DP119	CUTTING BOARD (19X119)	705-288B
31	DP41	CUTTING BOARD RETAINER	28D40-053B-05
	DP46	CUTTING BOARD RETAINER	107-429C-01
	DP67	CUTTING BOARD RETAINER	107-429C-02
	DP93	CUTTING BOARD RETAINER	107-429C-03
	DP119	CUTTING BOARD RETAINER	107-429C-04
32	ALL DP/UCR/WTR	GRILL ASSY. (FRONT)	28D37-033C
33	DP41/46/67/93/WTR/UCR41/46/ 67/93-A	CASTER ASSY.	29B02-015A
	DP/WT119	CASTER ASSY.	29B02-016A

PAN SUPPORTS 34" BASE REFRIGERATORS

ITEM	UNIT	DESCRIPTION	PART NUMBER
34	DP41	PAN SUPPORTS (1 NEEDED)	28D40-054B-05
	DP46	PAN SUPPORTS (2 NEEDED)	28D40-054B-05
	DP67	PAN SUPPORTS (5 NEEDED)	28D40-054B-05
	DP93	PAN SUPPORTS (3 NEEDED)	28D40-054B-05
	DP93	PAN SUPPORTS (1 NEEDED)	28D40-055B-05
	DP119	PAN SUPPORTS (4 NEEDED)	28D40-054B-05

REFRIGERATION 34" BASE REFRIGERATORS

ITEM	UNIT	DESCRIPTION	PART NUMBER
1	DP41/DP/UCR/WTR46/67-A	REFRIGERATION ASSEMBLY	19B36-078D
	DP93/119/UC/WT93-A	REFRIGERATION ASSEMBLY	19B36-079D-01
	UCR/WTR41	REFRIGERATION ASSEMBLY	19B36-042D
	UCR/WTR119-A	REFRIGERATION ASSEMBLY	19B36-062D-01
2	DP41/DP/UCR/WTR46/67-A	CONDENSING UNIT	15B01-038D
	DP/UCR/WTR41/93/119-A	CONDENSING UNIT	15B01-036D
3	DP41/DP/UCR/WTR46/67-A	COMPRESSOR1/6 HP (AE3440YXA)	302-803B
	DP/UCR/WTR41/93/119-A	COMPRESSOR1/5 HP (AE3430YXA)	302-804B
4	DP41/DP/UCR/WTR46/67-A	OVERLOAD (TI)MRP26ALL-69	302-815A
	DP/UCR/WTR41/93/119-A	OVERLOAD (TI) MRT24AIK-69	302-911A
5	DP41/DP/UCR/WTR46/67-A	RELAY (TI) 966-042-176	302-646B
	DP/UCR/WTR41/93/119-A	RELAY (TI) 9660-042-182	302-350A
6		START CAP.	NA
7	ALL	DRYER	303-143A
8	DP41/DP/UCR/WTR46/67-A	COND. COIL (11X10-7/8X2)	305-150C
	DP/UCR/WTR41/93/119-A	COND. COIL (11X10-7/8X3)	305-151C
9	DP41/DP/UCR/WTR46/67-A	COND. FAN MOTOR (5WATT) 115/60	501-148B
10	DP/UCR/WTR41/93/119-A	COND. FAN BLADE (6.75")	405-066B
11	DP41/DP/UCR/WTR46/67-A	EVAP. COIL ASSY.	19B31-014C
	DP93/119/UC/WT93-A	EVAP. COIL ASSY	19B31-015C
	UCR/WTR41	EVAP. COIL ASSY	20B30-100C
	UCR/WTR119-A	EVAP. COIL ASSY	20B30-111C
12	DP41/46/67 UCR/WTR41/46/67-A	EVAP. COIL ONLY (20X6X3)	305-172C
	DP93/119 UCR/WTR93/119-A	EVAP. COIL ONLY (20X7X4)	305-173C
*13	DP41/DP/UCR/WTR46/67-A	SUCTION LINE AND CAP. TUBE ASSY.	19B30-038D
	DP93/119/UC/WT93-A	SUCTION LINE AND CAP. TUBE ASSY.	19B30-039D
	UCR/WTR41	SUCTION LINE AND CAP. TUBE ASSY.	20B35-088D
	UCR/WTR119-A	SUCTION LINE AND CAP. TUBE ASSY.	20B35-098D
*14	DP41/46/67 UCR/WTR41/46/67-A	CAP. TUBE (.049ID X .099OD X 132)	203-039A--
	DP93/119 UCR/WTR93/119-A	CAP. TUBE (.054ID X .106OD X 120)	203-124A
*15	ALL	ACCUMULATOR	303-071A
*16	DP41/DP/UCR/WTR46/67-A	REFRIGERANT CHARGE	0.4219
	DP93/119/UC/WT93-A	REFRIGERANT CHARGE	0.594
	UCR/WTR41	REFRIGERANT CHARGE	0.4219
	UCR/WTR119-A	REFRIGERANT CHARGE	0.5938
*17	ALL	WIRING DIAGRAM	ILB-1351
*18	ALL	WIRE HARNESS	504-430C
*19	DP/UCR/WTR41/46/67	CONDENSATE PAN ASSY.	43B35-004C
	DP/UCR/WTR93/119	CONDENSATE PAN	43B35-005C

REFRIGERATION ASSEMBLY COMPONENTS
(REFRIGERATORS)

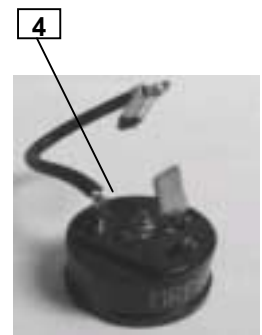
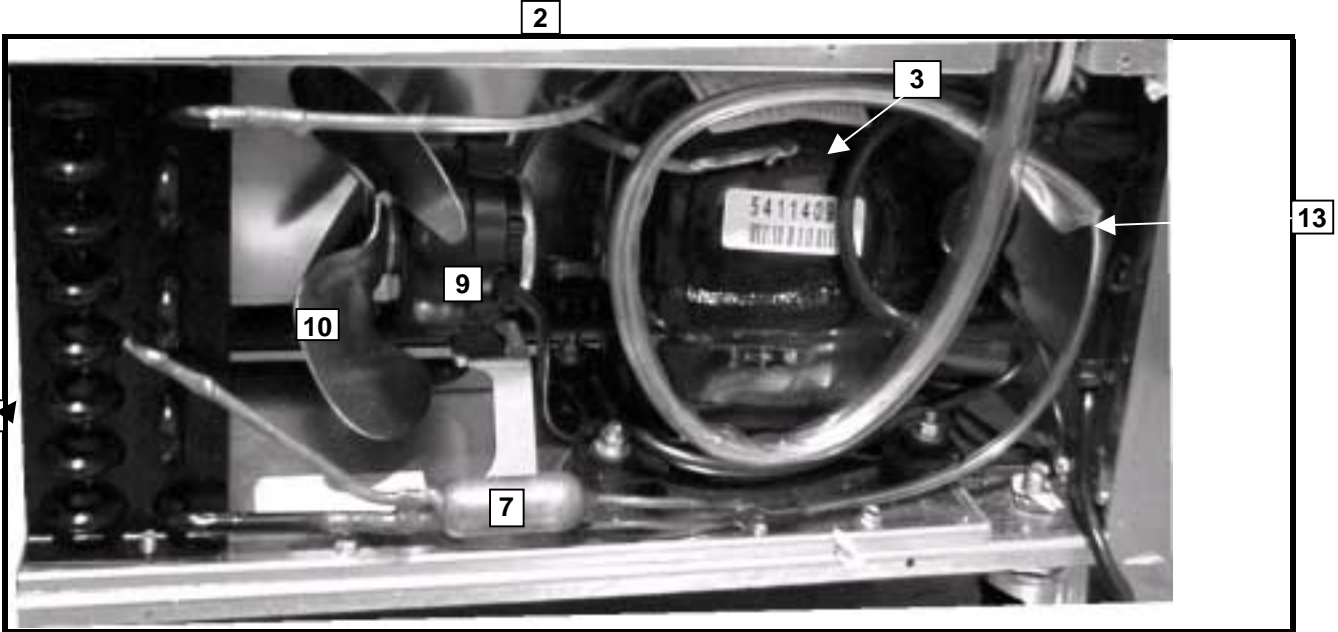

TOP ASSEMBLES
29" BASE REFRIGERATORS (CONTINUED)

ITEM	MODEL	DESCRIPTION	PART NUMBER
3	SP72-10/10C	TOP COVER ASSY.	01B36-085A-03
	SP72-12	TOP COVER ASSY.	01B36-085A-02
	SP72-12C	TOP COVER ASSY.	01B36-084A-01
	SP72-12M	TOP COVER ASSY.	01B36-075A-03
	SP72-18/18C/18M	TOP COVER ASSY.	01B36-075A-02
	SP72-24M	TOP COVER ASSY.	01B36-075A-01
	SP72-30M	TOP COVER ASSY.	01B36-076A-01
4	SP27/08/16/C/SPD27	TOP COVER (LID)	01B40-002D-01
	SP2712M	TOP COVER (LID)	01B40-001D-01
	SP48-08/08C	TOP COVER (LID)	01B40-002D-02
	SP48-10/10C	TOP COVER (LID)	01B40-002D-03
	SP48-12/12C	TOP COVER (LID)	01B40-002D-04
	SP48-12M	TOP COVER (LID)	01B40-001D-01
	SP48-18M	TOP COVER (LID)	01B40-001D-02
	SP60-08	TOP COVER (LID)	01B40-002D-02
	SP60-12	TOP COVER (LID)	01B40-002D-04
	SP60-12M	TOP COVER (LID)	01B40-001D-01
	SP60-16	TOP COVER (LID) (LH)	01B38-048D
	SP60-16	TOP COVER (LID) (RH)	01B38-047D
	SP60-16 (AFTER #5006876)	(SINGLE) TOP COVER LID	01B36-116D-01
	SP60-18M	TOP COVER (LID)	01B40-001D-03
	SP60-24M	TOP COVER (LID)	01B40-001D-04
	SP72-08/08C	COVER ONLY (LID)	01B40-002D-02
	SP72-10/10C/12	COVER ONLY (LID)	01B40-002D-03
	SP12C/12M/18C/18M	COVER ONLY (LID)	01B40-002D-04
	SP72-18	COVER ONLY (LID)	01B40-002D-04
	SP72-18M/18C	COVER ONLY (LONG LID)	01B40-002D-07
	SP72-18M/18C	COVER ONLY (SHORT LID)	01B40-002D-08
	SP72-24M/30M	COVER ONLY (LONG LID)	01B40-001D-04
	SP72-30M	COVER ONLY (SHORT LID)	01B40-001D-05
All	LID STUD. (2 PER LID)	604-094A	
5	SP27/27C/27-16	SERVING BAR (LID HOUSING)	01B36-093C-01
	SP27-12M	SERVING BAR (LID HOUSING)	01B36-077C-01
	SP48-08/08C	SERVING BAR (LID HOUSING)	01B36-098C-01
	SP48-10/10C	SERVING BAR (LID HOUSING)	01B36-094C-01
	SP48-12/12C	SERVING BAR (LID HOUSING)	01B36-098C-01
	SP48-12M	SERVING BAR (LID HOUSING)	01B36-100C-01
	SP48-18M	SERVING BAR (LID HOUSING)	01B36-078C-01
	SP60-08	SERVING BAR (LID HOUSING)	01B36-098C-01
	SP60-12	SERVING BAR (LID HOUSING)	01B36-095C-01
	SP60-12M	SERVING BAR (LID HOUSING)	01B36-077C-01
	SP60-16	SERVING BAR (LID HOUSING)	01B36-096C-01
	SP60-16(AFTER SERIAL#5006875)	(SINGLE)SERVING BAR (LID HOUSING)	01B36-114D-01
	SP60-18M	SERVING BAR (LID HOUSING)	01B36-078C-01
	SP60-24M	SERVING BAR (LID HOUSING)	01B36-079D-01
	SP72-08/08C	SERVING BAR (LID HOUSING)	01B36-098C-01
	SP72-10/10C	SERVING BAR (LID HOUSING)	01B36-094C-01
	SP72-12/12C	SERVING BAR (LID HOUSING)	01B36-095C-01
	SP72-18	SERVING BAR (LID HOUSING)	01B36-077D-01
	SP72-18M/18C	SERVING BAR (LID HOUSING)	01B36-097D-01
	SP72-18C	SERVING BAR (LID HOUSING)	01B36-078D-01
SP72-24M	SERVING BAR (LID HOUSING)	01B36-079D-01	
SP72-30M	SERVING BAR (LID HOUSING)	01B36-097D-01	
6	ALL/ SP	TOP COVER HANDLE	401-201A
	ALL/ SP	TOP COVER HANDLE SCREW	603-340A

* Indicates part not illustrated

1/28/2000

DOOR ASSEMBLES
29" BASE REFRIGERATORS

ITEM	MODEL	DESCRIPTION	PART NUMBER
7	SP/UC/WT27/60	D00R ASSEMBLY COMPLETE	02B01-249C
	SP/UC/WT48/72	D00R ASSEMBLY COMPLETE	02B01-253C
8	SP/UC/WT27/60	DOOR GASKET (23-18X24-1/2)	703-963D-02
	SP/UC/WT48/72	DOOR GASKET (21-1/16X23-1/8)	703-963D-03
9	ALL SP/UC/WT	DOOR HANDLE	401-506C
*10	ALL SP/UC/WT	DOOR HANDLE SCREWS	603-338A
11	ALL SP/UC/WT	DOOR HINGE (TOP/BOTTOM/LH&RH)	401-657B
*	ALL SP/UC/WT	HINGE COVER	401-244B
*	ALL SP/UC/WT	HINGE PIVOT CAM (NYLON)	401-242B
*12	ALL SP/UC/WT	THERMOMETER	402-233B

EVAPORATOR HOUSINGS
29" BASE REFRIGERATORS

ITEM	MODEL	DESCRIPTION	PART NUMBER
13	SP27/48 & UCR/WTR27A/48A	EVAP. HOUSING ASSY.	04B01-076D-02
	SP60/72 & UCR/WTR60/72A	EVAP. HOUSING ASSY.	04B01-077D-02
14	SP27/48 & UCR/WTR27A/48A	EVAP. COVER ASSY.	04B02-175D-02
	SP60/72 & UCR/WTR60/72A	EVAP. COVER ASSY.	04B02-177D-02
15	SP27/48 & UCR/WTR27A/48A	EVAP. BLADE	405-063A
16	SP60/72 & UCR/WTR60/72A	EVAP. MOTOR	501-105B
*17	SP27/48 & UCR/WTR27A/48A	EVAP. MOTOR BRACKET	42A37-011B
18	ALL SP/UC/WT	TEMP. CONT	502-290B

Evaporator pans below will be used for units produced before serial number **#5100522**. Units produced after this serial number have the evaporator pans incorporated into the cabinet and are not replaceable.

19	ALL SP27	EVAP. DRAIN PAN ASSY.	04B02-164C-01
	ALL SP48	EVAP. DRAIN PAN ASSY.	04B02-164C-02
	ALLSP60	EVAP. DRAIN PAN ASSY.	04B02-164C-03
	ALL SP72	EVAP. DRAIN PAN ASSY.	04B02-064C-04
	ALL SP48	EVAP. DRAIN PAN ASSY.	04B02-164C-02
	ALLSP60	EVAP. DRAIN PAN ASSY.	04B02-164C-03
	ALL SP72	EVAP. DRAIN PAN ASSY.	04B02-064C-04

SHELVES, CUTTING BOARDS & GRILLS
29" BASE REFRIGERATORS

ITEM	MODEL	DESCRIPTION	PART NUMBER
20	ALL SP	SHELF SUPPORT	403-169A
21	SP/27 & UCR/WTR27A	SHELF	403-628D
	SP48 & UCR/WTR48A	SHELF	403-630D
	SP60 & UCR/WTR60A	SHELF	403-631D
	SP72 & UCR/WTR72A	SHELF (CTR)	403-629D
	SP72 & UCR/WTR72A	SHELF. (END)	403-630D
22	SP/UCR/WTR	PILASTER (15")	403-154A
*23	SP/UCR/WTR	PILASTER SCREWS	603-415A
24	ALL SP27	CUTTING BOARD (10" WIDE)	705-290C-01
	SP48-08/08C/10/10C/12	CUTTING BOARD (10" WIDE)	705-290C-02
	SP48-12C/12M/18M	CUTTING BOARD (17" WIDE)	705-265C
	ALL SP60	CUTTING BOARD (10" WIDE)	705-290C-03
	SP72-08/08C/10/12/12M/18/18M/24/30M	CUTTING BOARD (10" WIDE)	705-290C-04
	SP72-18C	CUTTING BOARD (17" WIDE)	705-267C
25	SP27	CUTTING BOARD RETAINER	107-430C-01
	SP48	CUTTING BOARD RETAINER	107-430C-02
	SP60	CUTTING BOARD RETAINER	107-430C-03
	SP72	CUTTING BOARD RETAINER	107-430C-04

SHELVES, CUTTING BOARDS & GRILLS
29" BASE REFRIGERATORS (CONTINUED)

ITEM	MODEL	DESCRIPTION	PART NUMBER
26	SP27 & UCR/WTR27A	GRILL ASSY. (FRONT)	07B31-061B
	SP48 & UCR/WTR48A	GRILL ASSY. (FRONT)	07B31-057B
	SP60 & UCR/WTR60A	GRILL ASSY. (FRONT)	07B31-059B
	SP72 & UCR/WTR72A	GRILL ASSY. (FRONT)	07B31-055B
27	SP27 & UCR/WTR27A	GRILL ASSY. (REAR)	28D37-090D-03
	SP48 & UCR/WTR48A	GRILL ASSY. (REAR)	28D37-091D-03
	SP60 & UCR/WTR60A	GRILL ASSY. (REAR)	28D37-092D-03
	SP72 & UCR/WTR72A	GRILL ASSY. (REAR)	28D37-093D-03
28	ALL SP	CASTER KIT	00C31-038A

PAN SUPPORTS

29" BASE REFRIGERATORS

ITEM	UNIT	DESCRIPTION	PART NUMBER
29	SP27/27C/SPD27/SP72-12M	PAN SUPPORTS 3 NEEDED	28D40-056C-05
	SP27-16	PAN SUPPORTS 5 NEEDED	28D40-056C-05
	SP27-12M/SP60-12M	PAN SUPPORTS 3 NEEDED	28D40-051C-05
	SP48-18M/SP60-12M/SP72-18M	PAN SUPPORTS 5 NEEDED	28D40-051C-05
	SP60-24M/SP72-24M	PAN SUPPORTS 6 NEEDED	28D40-051C-05
	SP72-30M	PAN SUPPORTS 8 NEEDED	28D40-051C-05
	SP48-12/SP60-12/SP72-12/12C	PAN SUPPORTS 5 NEEDED	28D40-060C-05
	SP60-10/SP72-10/10C	PAN SUPPORTS 3 NEEDED	28D40-060C-05
	SP48-10/SP72-10/10C	PAN SUPPORTS 4 NEEDED	28D40-060C-05
	SP60-16/SP72-18/18C	PAN SUPPORTS 7 NEEDED	28D40-060C-05

PANS

29" BASE REFRIGERATORS

ITEM	UNIT	DESCRIPTION	PART NUMBER
30	SP27 & 27C	PANS 1/6 4" DEEP (6 NEEDED)	403-490C
		PANS 1/9 4" DEEP (2 NEEDED)	403-493C
	SP48-08C & SP60-08C	PANS 1/6 4" DEEP (8 NEEDED)	403-490C
		PANS 1/6 4" DEEP (10 NEEDED)	403-490C
	SP48-18M	PANS 1/6" DEEP(6 NEEDED)	403-490C
		PANS 1/2" DEEP (2 NEEDED)	403-495C
	SP60-12C	PANS 1/6" DEEP (12 NEEDED)	403-490C
		SP60-18M	PANS 1/6" DEEP (6 NEEDED)
	PANS 1/2" DEEP (2 NEEDED)		403-495C
	PANS FULL 4" DEEP (1 NEEDED)		403-497C
	SP60-24M	PANS 1/4" DEEP (4 NEEDED)	403-490C
		PANS 1/2" DEEP (2 NEEDED)	403-495C
	SP72-12M	PANS 1/6 4" DEEP (6 NEEDED)	403-490C
		PANS 1/2" DEEP (2 NEEDED)	403-495C
	SP72-18M	PANS 1/6 4" DEEP (6 NEEDED)	403-490C
		PANS 1/2" DEEP (2 NEEDED)	403-495C
		PANS FULL 4" DEEP (1 NEEDED)	403-497C
	SP72-24M	PANS 1/6 4" DEEP (12 NEEDED)	403-490C
		PANS 1/2" DEEP (2 NEEDED)	403-495C
		PANS FULL 4" DEEP (1 NEEDED)	403-497C
	SP72-30M	PANS 1/4" DEEP (18 NEEDED)	403-490C
		PANS 1/2" DEEP (2 NEEDED)	403-495C
		PANS FULL 4" DEEP (1 NEEDED)	403-497C

REFRIGERATION 29" BASE REFRIGERATORS

ITEM	UNIT	DESCRIPTION	PART NUMBER
1	SP27/UCR27A/WTR27A	REFRIGERATION ASSEMBLY	19B36-086D-01
	SP48/UCR48A/WTR48A	REFRIGERATION ASSEMBLY	19B36-087D-01
	SP60/UCR60A/WTR60A SP72/UCR72A/WTR72A	REFRIGERATION ASSEMBLY	19B36-088D-01
2	SP27/UCR27A/WTR27A	CONDENSING UNIT	15B33-045C
	SP48/UCR48A/WTR48A	CONDENSING UNIT	15B33-043C
	SP60/UCR60A/WTR60A SP72/UCR72A/WTR72A	CONDENSING UNIT	15B33-051C
3	SP27/UCR27A/WTR27A	1/6 HP (AZA0370YXA)	302-687B
	SP48/UCR48A/WTR48A	1/5 HP (AZA0395YXA)	302-687B
	SP60/UCR60A/WTR60A SP72/UCR72A/WTR72A	1/4 HP (AEA3430YXA)	302-803B
4	SP27/UCR27A/WTR27A	COMP.OVERLOAD (TI) MRP57ALK-69	302-688A
	SP48/UCR48A/WTR48A	COMP. OVERLOAD (TI) MRP40AJN-69	302-918A
	SP60/UCR60A/WTR60A SP72/UCR72A/WTR72A	COMP. OVERLOAD (TI) MRP26ALL-69	302-815A
5	SP27/UCR27A/WTR27A	COMP. RELAY (TI) 9660-042-152	302-702A
	SP48/UCR48A/WTR48A	COMP. RELAY (TI) 9660-071-161	302-677A
	SP60/UCR60A/WTR60A SP72/UCR72A/WTR72A	COMP. RELAY (TI) 9660-042-176	302-646A
6	SP27/UCR27A/WTR27A	COMP. START CAPACITOR	NA
	SP48/UCR48A/WTR48A	COMP. START CAPACITOR.(161-193MFD)	302-919A
	SP60/UCR60A/WTR60A SP72/UCR72A/WTR72A	COMP. START CAPACITOR	NA
7	ALL SP/UC/WT	DRYER	303-126A
8	SP27/48 & UCR/WTR27A/48A	COND. COIL (5-5/16X7-7/8X3)	305-144C
	SP60/72 & UCR/WTR60A/72A	COND. COIL (5-5/16x7-7/8x4)	305-155C
9	ALL SP/UC/WT	COND. FAN MOTOR (5WATT) 115/60	501-019B
10	ALL SP/UC/WT	COND. FAN BLADE (6.75")	405-015A--
11	SP27/UCR27A/WTR27A	EVAP. COIL ASSY.	19B31-021D
	SP48/UCR48A/WTR48A	EVAP. COIL ASSY	19B31-022D
	SP60/UCR60A/WTR60A SP72/UCR72A/WTR72A	EVAP. COIL ASSY.	19B31-023D
12	SP27/UCR27A/WTR27A	EVAP. COIL ONLY (20X4X3)	305-175C
	SP48/UCR48A/WTR48A	EVAP. COIL ONLY (20X4X4)	305-176C
	SP60/UCR60A/WTR60A SP72/UCR72A/WTR72A	EVAP. COIL ONLY 30X4X4	305-154C
13	SP27/48 & UCR/WTR27A	SUCTION LINE AND CAP. TUBE ASSY.	19B30-044D
	SP60/72 & UCR/WTR60/72A	SUCTION LINE AND CAP. TUBE ASSY.	19B30-045D
14	SP27/48 & UCR/WTR27A	CAP. TUBE (.036IDX.087ODX120")	203-048A--
	SP60/72 & UCR/WTR60/72A	CAP. TUBE (.036IDX.087ODX84)	203-126A
15	ALL SP/UC/WT	ACCUMULATOR	303-071A
16	SP27/UCR27A/WTR27A	REFRIGERANT 0.4375 LBS	R134A
	SP48/UCR48A/WTR48A	REFRIGERANT 0.453 LBS	R134A
	SP60/UCR60A/WTR60A SP72/UCR72A/WTR72A	REFRIGERANT 0.4375 LBS	R134A
17	ALL SP	WIRING DIAGRAM	IL-1792B
18	SP27/48	WIRE HARNESS	504-762C
	UCR/WTR27/48A	WIRE HARNESS	504-430C
	SP60/72	WIRE HARNESS	504-764C
	UCR/WTR 60/72A	WIRE HARNESS	504-298C
19	ALL SP	CONDENSATE PAN ASSY.	08B30-041D-01
	ALL UCR/WTR	CONDENSATE PAN	706-047C
	SP72(BEFORE #5308510) SP72(AFTER #5308510)	CONDENSATE PAN W/O HEATER CONDENSATE PAN HEATER	28D24-040C-04 504-763B-01

* Indicates part not illustrated

1/28/2000

REFRIGERATION ASSEMBLY COMPONENTS
(REFRIGERATORS)

