



# MODEL 630

This versatile unit shrink-wraps pizzas, deli platters, and hors d'oeuvre trays in seconds. Easy as 1-2-3!

**\*\*This unit requires the use of a food safe, heat activated shrink film. Not for use with a standard cling/plastic wrap.\*\***

## FEATURES:

- INCLUDES ADAPTER DISC FOR 10"-12" PIZZAS
- High watt density heating element
- Thermostatically controlled heating element provides controlled heat for continuous or intermittent operation
- Heat shroud reduces temperatures to prevent film sticking and provides extra measure of safety to prevent burns

## AVAILABLE ACCESSORIES:

Model 650-1-BW Single tier film dispenser

Model 650-BW 2 tier film dispenser

0016239

14" - 16" pizza adapter disc

0016240

6" - 8" pizza adapter disc

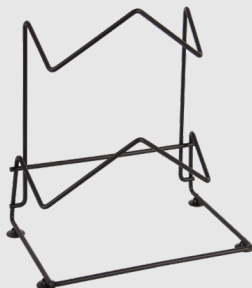

## ELECTRICAL DATA:

<b>VOLTS:</b>	120	<b>AMPS:</b>	12.5	<b>WATTS:</b>	1500
---------------	-----	--------------	------	---------------	------

- Best when operated on an individual branch circuit
- Approx. 70" power cord length

## DIMENSIONS:

- External: 12"W x 12"D x 7"H
- 14" Diameter Protective Shield

## SHIPPING INFORMATION:

- SHIPPING DIMENSIONS: 16"W x 17"D x 10"H
- SHIPPING WEIGHT: 13 LBS.



**IMPORTANT: Read the following safety and operation instructions to avoid damage to equipment or property.**

- Remove Deli-Wrap from carton
- Remove cardboard from bottom of unit and heating element.

 **(CAUTION: DO NOT PLUG UNIT IN WITH CARDBOARD HEATING ELEMENT SUPPORT IN PLACE).**

- Screw threaded rod into disc.
- Thread wing nut on the opposite end of rod so the wings of the nut face jam nut.
- Thread disc and rod assembly into grille assembly until the height is approx. 4-1/2" to 5".
- Lock wing nut against grille assembly. (The 4-1/2" to 5" dimension given is only a starting place. Due to the differences in wrapping mediums, you may have to adjust your pedestal height to attain best wrapping results.)
- Place grille with pedestal assembly on the brackets riveted to the inner shroud.
- Clean out tray can then be put in place. Clean out tray should be centered between shroud support brackets and resting on the base of the unit.

 **CAUTION: THE CARDBOARD SUPPORT MUST BE REMOVED FROM THE HEATING ELEMENT BEFORE ENERGIZING UNIT.**

 Plug unit into a properly grounded electrical outlet of the correct voltage, size, and plug configuration for this unit. We recommend usage on an individual branch circuit of at least 15 amps for best results. Failure to do so may result in decreased performance of the warmer.

 Exterior surfaces on unit may get hot. Use caution when touching these areas to avoid injury.

 Unplug warmer when not in use.

### CLEANING INSTRUCTIONS

 Unit is not waterproof. Do not submerge in water. Do not operate if unit has been submerged in water.

 Unplug unit from power source, and allow to cool completely before performing any maintenance or cleaning.

 Do not steam clean or use excessive water on unit to avoid personal injury or electrical shock.

It is recommended that the interior and exterior surfaces be cleaned daily with a mild soap and damp cloth. Stubborn stains on base of unit and/or shelves may be removed with a non-abrasive cleaner and a damp cloth. Usage of an abrasive cleanser could scratch or damage the finish of your unit.

### OPERATION:

Plug unit in and turn the thermostat switch to the Medium to High position. Pre-heat Deli Wrap machine for approximately 3 minutes.

Place the product being wrapped on the center of the pedestal, immediately tear off a sheet of shrink wrap material from the Deli-Wrap dispenser and place over product paying special attention to the symmetry. Best results will be achieved if the wrapping material is evenly laid over the product.

In approximately 10 to 20 seconds your product will be enveloped and sealed. Remove from pedestal and allow to cool. **CAUTION: DO NOT LEAVE PRODUCT UNATTENDED WHEN WRAP-**



# Pizzawrap and Capper

FAST and EFFICIENT

4 SIMPLE  
STEPS



**Step 1:** Tear shrink film at the perforation

\*Be sure to place film on dispenser so it feeds from the bottom. If you pull film from "over" the roll tearing could occur.

**Step 2:** Place cardboard round w/pizza on heated deli wrapper;  
Place shrink film on top of pizza

**Step 3:** Allow deli wrapper to shrink film around pizza.

**Step 4:** Professionally wrapped pizza is now ready for sale.



\*\*This unit requires the use of a food safe, heat activated shrink film. Not for use with a standard cling/plastic wrap.\*\*

# Model 630-1 Exploded View

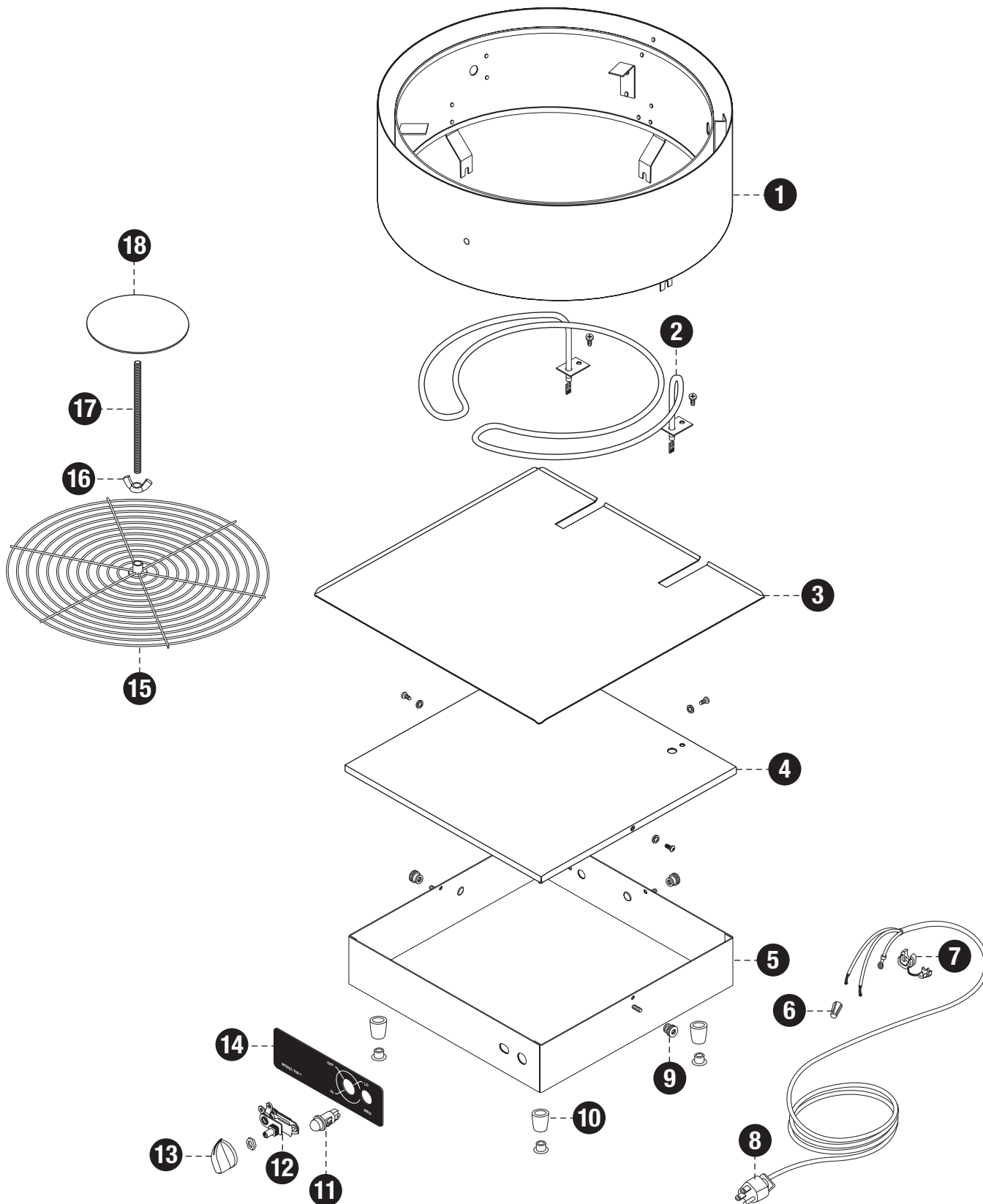

Rev. Date: 05/24/2012

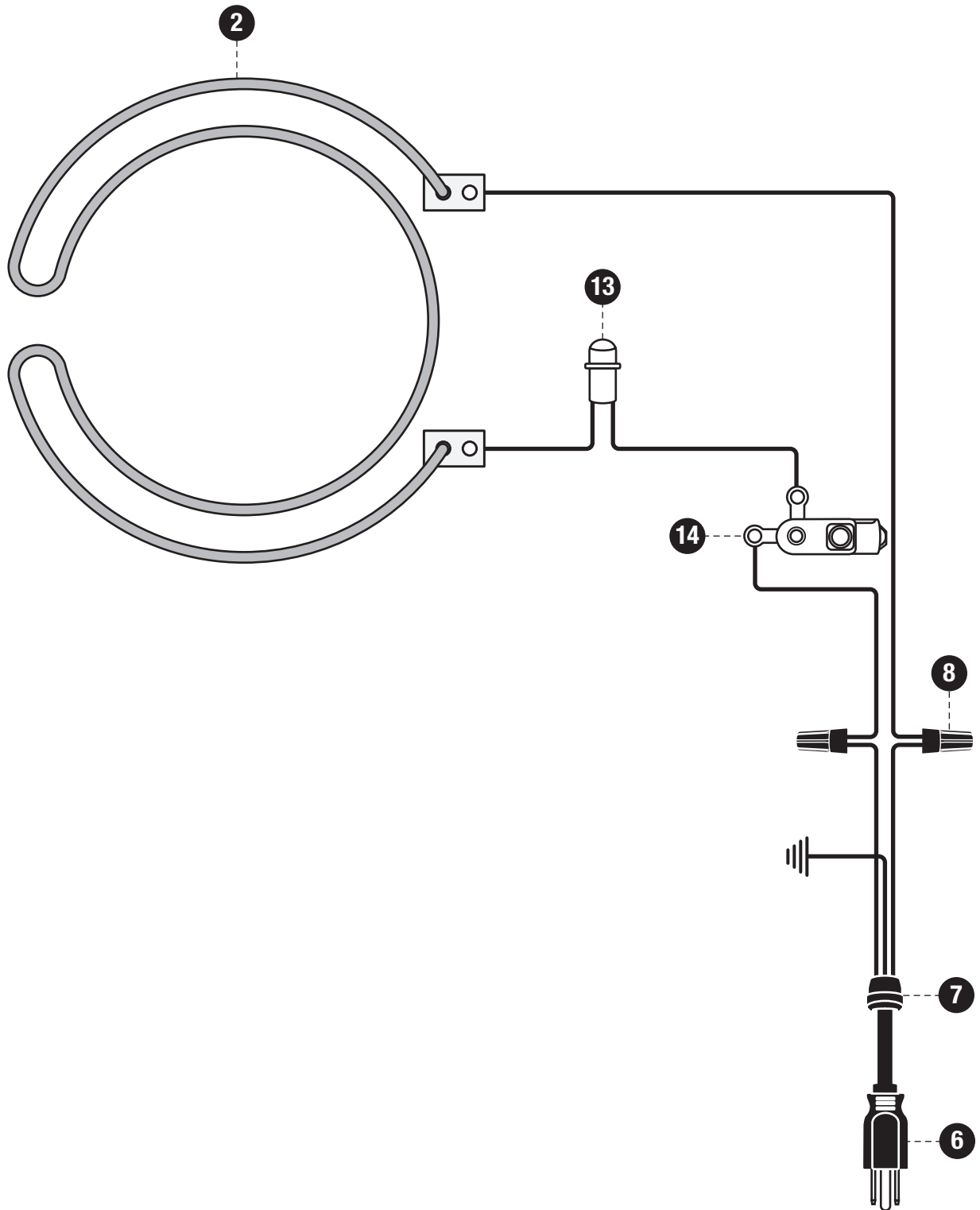

**PARTS LIST:****MODEL 630**

<b>ITEM #</b>	<b>PART#</b>	<b>DESCRIPTION</b>
1.	0016220	SHROUD ASSEMBLY
2.	0016000	1500W HEATING ELEMENT
3.	0016018	CLEAN OUT TRAY
4.	0016006	TOP
5.	0016215	CASE (630-1)
6.	00140	WIRE NUT
7.	00131	STRAIN RELIEF
8.	00448	POWER CORD
9.	00116	THUMB NUT 10-24
10.	0018032SK	BOTTOM FOOT SERVICE KIT
11.	009092	RED PILOT LIGHT
12.	0016015	THERMOSTAT
*	0016119	ON/OFF SWITCH
13.	00100	THERMOSTAT KNOB
14.	I013154	630-1 CONTROL DECAL
15.	0016002	GRILL STAND
16.	0016009	3/8 - 16 WING NUT
17.	0016011	ROD, THREADED
18.	0016240	3-1/2" ADAPTER DISC (for 6-8" pizzas)
*	0016244	DISC W/NUT (for 10-12" pizzas)
*	0016239	10" ADAPTER DISC (for 14-16" pizzas)
*	0016030	14-1/2" WHITE WIRE LEAD
*	0016031	13" WHITE WIRE LEAD
		*Need 1 of each #0016030 & #0016031 for old style unit only
*	00650-1-BW	SINGLE TIER SHRINK FILM DISEPENSER
*	00650-BW	2 TIER SHRINK FILM DISPENSER

## 1 YEAR REPLACEMENT/EXCHANGE

Wisco Industries, Inc. warrants its equipment against defects in materials and workmanship subject to the following conditions:

Should any product fail to function in its intended manner under normal use within the limits defined in this warranty, Wisco Industries will determine if the item is to be repaired or replaced by Wisco Industries. Failure to follow authorizing instructions may void any claim and/or warranty.

\* Contact Wisco Industries for repair/replacement by calling (608) 835-3106 or toll free (800) 999-4726.

You can also email us at: [contact@wiscoind.com](mailto:contact@wiscoind.com)

\* An authorizing RMA# must be obtained through Wisco Industries BEFORE any warranty issues can be resolved. Failure to do so in advance may void the warranty/claim resulting in Wisco Industries not being responsible for any incurred expenses and/or charges.

\* At time of call Wisco Industries will assist you in:

- getting your unit replaced/exchanged
- and/or obtaining repair parts
- and/or authorizing a service agent

This warranty covers products shipped into the 48 contiguous United States, Hawaii and metropolitan areas of Alaska only. Warranty for international or areas not listed above will consist of replacement of parts only. There will be no labor coverage and parts must be shipped to an address within the 48 contiguous United States, Hawaii or metropolitan areas of Alaska only.

### Time Period

One year from date of shipment from our manufacturing facility. Parts replaced under this warranty are warranted for the un-expired portion of the original product warranty only.

### Exclusions

The following conditions are not covered by warranty:

- Equipment failure relating to improper installation and improper utility connection or supply.
- Equipment that has not been properly maintained or damage from improper cleaning and/or water damage to controls.
- Equipment that has not been used for its intended purpose or has been subject to misuse or misapplication, neglect, abuse, accident, alteration, negligence, damage during subsequent transit, delivery or installation, fire, flood, riot or act of god.
- Equipment that has the model number or serial number removed or altered.

WISCO INDUSTRIES, INC. DISCLAIMS AND EXCLUDES ANY AND ALL OTHER EXPRESS OR IMPLIED WARRANTIES, INCLUDING WITHOUT LIMITATION, ANY AND ALL WARRANTIES OF MERCHANTABILITY OR FITNESS FOR A PARTICULAR PURPOSE.

Buyer agrees that its SOLE AND EXCLUSIVE REMEDY against Wisco and Wisco's SOLE AND EXCLUSIVE LIABILITY arising out of any defect or nonconformity in the product shall be replacement/exchange of such nonconforming countertop food service equipment at Wisco's expense. No countertop food service equipment shall be returned without Wisco's consent. IT IS AGREED THAT WISCO'S MAXIMUM LIABILITY SHALL NOT IN ANY CASE EXCEED THE SALE PRICE FOR THE COUNTERTOP EQUIPMENT CLAIMED TO BE DEFECTIVE OR NONCONFORMING.

Without limiting the generality of the foregoing, SUCH WARRANTIES DO NOT COVER: Glass, plastic enclosures/panels, door assemblies, hardware, light bulbs & wire pizza oven heating elements.

---

## SHIPPING DAMAGE

If the outside packaging of your order is visibly dented, crushed, torn or otherwise significantly damaged, or if you move the carton and you hear broken glass, please reject the shipment while driver is still with you if possible. Please call us at (800)999-4726 or email [contact@wiscoind.com](mailto:contact@wiscoind.com) to notify us of the issue. We will confirm the damage with the carrier and re-ship your order immediately.

---

## RETURN POLICY

You may return any unused, undamaged items within 30 days of receipt at your expense. We will issue a refund in the form of your original payment, less a 20% restock fee. Wisco Industries will not reimburse any shipping and handling fees. All returns must be received in resalable condition. Wisco Industries will not accept a return with shipping damage.

If you would like to return an item please call us at 608-835-3106 or toll free at 1-800-999-4726 and ask for our Food Service Equipment Division or you may send an email to us at: [contact@wiscoind.com](mailto:contact@wiscoind.com) You will be given a return # and return instructions. We can not accept returns without a return #. Please be sure to include a copy of the packing list with the return.