



**INSTALLATION  
AND  
OPERATING  
INSTRUCTIONS**

Models: **WS-2, WS-3, WS-4, WS-5, WS-6**

**WARMING SHELVES**  
INTENDED FOR OTHER THAN HOUSEHOLD USE

**RETAIN THIS MANUAL FOR FUTURE REFERENCE  
UNIT MUST BE KEPT CLEAR OF COMBUSTIBLES AT ALL TIMES**

**IMPORTANT FOR FUTURE REFERENCE**

Please complete this information and retain this manual for the life of the equipment. For Warranty Service and/or Parts, this information is required.

\_\_\_\_\_   
Model Number

\_\_\_\_\_   
Serial Number

\_\_\_\_\_   
Date Purchased



**WARNING:** Improper installation, adjustment, alteration, service or maintenance can cause property damage, injury or death. Read the Installation, Operating and Maintenance Instructions thoroughly before installing or servicing this equipment.



This equipment has been engineered to provide you with year-round dependable service when used according to the instructions in this manual and standard commercial kitchen practices.

Phone: +1 (307) 634-5801  
Fax: +1 (307) 637-8071  
Toll Free: +1 (800) 752-0863  
Website: [www.apwwyott.com](http://www.apwwyott.com)  
E-mail: [info@apwwyott.com](mailto:info@apwwyott.com)

P/N 8806100 Rev. 9/05

**APW WYOTT**  
P.O. Box 1829  
Cheyenne, WY 82003

**APW Wyott** takes pride in the design and quality of our products. When used as intended and with proper care and maintenance, you will experience years of reliable operation from this equipment. To ensure best results, it is important that you read and follow the instructions in this manual carefully.



Installation and start-up should be performed by a qualified installer who thoroughly read, understands and follows these instruction.



If you have questions concerning the installation, operation, maintenance or service of this product, write Technical Service Department APW/Wyott Foodservice Equipment Company, P.O. Box 1829, Cheyenne, WY 82003.



## SAFETY PRECAUTIONS



Before installing and operating this equipment be sure everyone involved in its operation are fully trained and are aware of all precautions. Accidents and problems can result by a failure to follow fundamental rules and precautions.

The following words and symbols, found in this manual, alert you to hazards to the operator, service personnel or the equipment. The words are defined as follows:

 **DANGER:** This symbol warns of imminent hazard which will result in serious injury or death. 



 **WARNING:** This symbol refers to a potential hazard or unsafe practice, which could result in serious injury or death. 



 **CAUTION:** This symbol refers to a potential hazard or unsafe practice, which may result in minor or moderate injury or product or property damage. 



 **NOTICE:** This symbol refers to information that needs special attention or must be fully understood even though not dangerous. 



---



---



 **CAUTION:** These models are designed, built, and sold for commercial use. If these models are positioned so the general public can use the equipment make sure that cautions, warnings, and operating instructions are clearly posted near each unit so that anyone using the equipment will use it correctly and not injure themselves or harm the equipment. 



 **WARNING:** Check the data plate on this unit before installation. Connect the unit only to the voltage and frequency listed on the data plate. Connect only to 1 or 3 phase as listed on the data plate. 



 **WARNING:** Electrical and grounding connections must comply with the applicable portions of the national electrical code and/or other local electrical codes. 



 **WARNING:** Disconnect device from electrical power supply and place a Tag Out-Lockout on the power plug, indicating that you are working on the circuit. 



 **WARNING:** Never clean any electrical unit by immersing it in water. Turn off before cleaning surface. 



 **WARNING:** Install per the spacing requirements listed in the installation section of this manual. We strongly recommend having a competent professional install the equipment. A licensed electrician should make the electrical connections and connect power to the unit. Local codes should always be used when connecting these units to electrical power. In the absence of local codes, use the latest version of the National Electrical Code. 

 **WARNING: This appliance must be serviced by an Authorized Service Technician only. Disconnect the power supply before cleaning or servicing the oven.**   
Regular and thorough cleaning will help to keep the ovens operating properly. If service is required, contact an Authorized Service Agency, your dealer or the factory to obtain a qualified technician for the required maintenance/service.

 **WARNING:** An earthing cable must connect the appliance to all other units in the complete installation and from there to an independent earth connection. 

 **NOTICE:** The unit when installed, must be electrically grounded and comply with local codes, or in the absence of local codes, with the national electrical code ANSI/NFPA70- latest edition. Canadian installation must comply with CSA-STANDARD C.22.2 Number 0 M1982 General Requirements-Canadian Electrical Code Part II, 109-M1981-Commercial Cooking Appliances. 

 **NOTICE:** Local codes regarding installation vary greatly from one area to another. The National Fire Protection Association, Inc. states in its NFPA96 latest edition that local codes are “Authority Having Jurisdiction” when it comes to requirement for installation of equipment. Therefore, installation should comply with all local codes. 

 **WARNING: SHOCK HAZARD** - De-energize all power to equipment before cleaning the equipment. 

## CONTENTS

Safety Precautions.....	2
Specifications.....	4
Installation.....	4
Electrical Connections.....	5
Operating Instructions.....	5
Maintenance.....	5
General Troubleshooting.....	6
Wiring Diagram.....	6
Parts Lists & Exploded View.....	7
Warranty.....	11

### LOCATION OF DATA PLATE

The data plate for the warming shelf is located on the back of the unit by the power cord.



### IMMEDIATELY INSPECT FOR SHIPPING DAMAGE



All containers should be examined for damage before and during unloading. The freight carrier has assumed responsibility for its safe transit and delivery. If equipment is received damaged, either apparent or concealed, a claim must be made with the delivering carrier.

A) Apparent damage or loss must be noted on the freight bill at the time of delivery. It must then be signed by the carrier representative (Driver). If this is not done, the carrier may refuse the claim. The carrier can supply the necessary forms.

B) Concealed damage or loss if not apparent until after equipment is uncrated, a request for inspection must be made to the carrier within 15 days. The carrier should arrange an inspection. Be certain to hold all contents and packaging material.

Installation and start-up should be performed by a qualified installer who thoroughly read, understands and follows these instructions.

 **WARNING:** This product is intended for commercial use only. Not for household use. Retain this manual for future reference. Oven must be kept clear of combustibles at all times. 

 **CAUTION:** These models are designed, built, and sold for commercial use. If these models are positioned so the general public can use the equipment, make sure that cautions, warnings, and operating instructions are clearly posted near each unit so that anyone using the equipment will use it correctly and not injure themselves or harm the equipment. 



## SPECIFICATIONS



### DOMESTIC MODELS

MODEL	DESCRIPTION	ELECTRICAL	DIMENSIONS
WS-2	24" surface	120V, 200W, 1.7 Amps	2 3/8" H x 18" W x 24" L
WS-3	36" surface	120V, 300W, 2.5 Amps	2 3/8" H x 18" W x 36" L
WS-4	48" surface	120V, 400W, 3.3 Amps	2 3/8" H x 18" W x 48" L
WS-5	60" surface	120V, 500W, 4.2 Amps	2 3/8" H x 18" W x 60" L
WS-6	72" surface	120V, 600W, 5.0 Amps	2 3/8" H x 18" W x 72" L

### EXPORT MODELS

MODEL	DESCRIPTION	ELECTRICAL	DIMENSIONS
WS-2	24" surface	220v, 200W, .9 Amps	2 3/8" H x 18" W x 24" L
WS-3	36" surface	220V, 300W, 1.3 Amps	2 3/8" H x 18" W x 36" L
WS-4	48" surface	220V, 400W, 1.8 Amps	2 3/8" H x 18" W x 48" L
WS-5	60" surface	220V, 500W, 2.2 Amps	2 3/8" H x 18" W x 60" L
WS-6	72" surface	220V, 600W, 2.7 Amps	2 3/8" H x 18" W x 72" L

 **WARNING: SHOCK HAZARD** - Do not open any panels that require the use of tools. 

 **WARNING:** Improper installation, adjustment, alteration, service or maintenance can cause property damage, injury or death. Read the Installation, Operating and Maintenance Instructions thoroughly before installing or servicing this equipment. 

## INSTALLATION

The warming shelf has been inspected and tested at the factory prior to shipment.



Unpack the warming shelf and remove all packing materials. Place it on a flat, horizontal surface at the desired location.

Clean the unit before using. Wipe body and the inside of the unit with a hot, wet cloth to remove any shipping dust or protective oil.

**NOTE:** At 120 volts, this unit draws up to 5 amperes. If connected to a circuit loaded down with too many other appliances, the fuse will blow out or the circuit breaker will trip, or a reduction in performance will be experienced.

All food service equipment should be operated by trained personnel.

Never hold food below 150°F or above 40°F.

 **WARNING:** This unit is not intended to hold potentially hazardous foods such as un-cooked or un-preserved meats and sausages. 

## ELECTRICAL CONNECTIONS

Check the data plate to determine for which voltage this unit is wired and what voltage service is to use. These units have been provided with the appropriate cord and plug set. Do not attempt to defeat its purpose by substituting a plug with different configuration.

When installed, the plug for this unit should be accessible.



**CAUTION:** Check the data plate on this unit before installation. Connect the unit only to the voltage and frequency listed on the data plate. Connect only to 1- or 3-phase as listed on the data plate.



**CAUTION:** If the power cord is damaged, replace only with an identical power cord.



**WARNING:** Improper grounding could result in electrical shock. This appliance is equipped with a three-prong (grounded plug) for your protection against shock hazard and should be plugged directly into a properly grounded three-prong receptacle. Do not cut or remove the grounding prong from this plug.



## OPERATING INSTRUCTIONS

1. Switch power to on. NOTE: auxiliary outlet will be energized at this time.
2. Adjust heater to a setting of 7 1/2.
3. Allow 20-30 minutes for unit to come up to temperature. Surface temperature of the shelf will be between 180°F and 190°F. If too hot or too cool, adjust knob to a better setting for the product. Higher numbers are hotter and lower numbers are cooler.

## MAINTENANCE

Once a week, or more often if necessary, clean the warming shelf thoroughly. Turn off the warming shelf and allow it to cool.

**STAINLESS STEEL:** To remove normal dirt or product residue from stainless steel, use ordinary soap and water (with or without detergent) applied with a sponge or cloth. Dry thoroughly with a clean cloth. Never use vinegar or corrosive cleaner. Do not use chlorine based cleaners.

To remove grease and food splatter or condensed vapors that have hardened on the equipment, apply cleaners to a damp cloth or sponge and rub cleanser on the metal in the direction of the polished lines on the metal. Rubbing cleanser as gently as possible in the direction of the polished lines will not mar the finish of the stainless steel. NEVER RUB WITH A CIRCULAR MOTION. Soil and burned on deposits which do not respond to the above procedure can usually be removed by rubbing the surface with SCOTCH-BRITE scouring pads or STAINLESS scouring pads.

**NEVER USE** a wire brush, steel or abrasive scouring pads (except stainless), scraper, file or other steel tools. Surfaces which are marred collect dirt more rapidly and become more difficult to clean. Marring also increases the possibility of corrosive attack.

**NEVER** use any corrosive cleaner. Use only cleaners approved for stainless steel.

**NEVER** use cleaning solvents with a hydrocarbon base.



**WARNING:** Never clean any electrical unit by immersing it in water. Turn off before cleaning surface.



**CAUTION:** Do not use ordinary steel wool as any particles left on the surface will rust.



**WARNING: SHOCK HAZARD** - De-energize all power to equipment before cleaning the equipment.



# GENERAL TROUBLESHOOTING

If the unit fails to operate, check the following.

1. Make sure the unit is connected to a live power source.
2. Check the circuit breaker to be sure it has not been tripped.
3. Check if the power switch is on and the indicator light is glowing.
4. Check the data plate and make sure the unit is operating on the proper voltage.

If the above checks out and you still have problems, call an APW Wyott Foodservice authorized service agency.

**NOTICE:** Service work should be performed only by a qualified technician who is experienced in and knowledge-able with the operation of commercial gas, electric, steam cooking equipment. Contact the Authorized Service Agency for reliable service, dependable advice or other assistance and for genuine factory parts.

Warranty will be void and the manufacturer is relieved of all liability if:

- A. Service work is performed by other than an APW Wyott Foodservice authorized Service Agency; or
- B. Other than Genuine APW Wyott Foodservice replacement parts are installed.

A current listing of all authorized APW Wyott Foodservice authorized parts/service distributors is included with this product manual at the time of shipment. In the absence of this list, you can call the APW Wyott 24-hour Service Hot Line which gives access to the nearest Authorized APW Wyott parts/service distributor. Call 1-800-733-2203.

## WIRING DIAGRAM

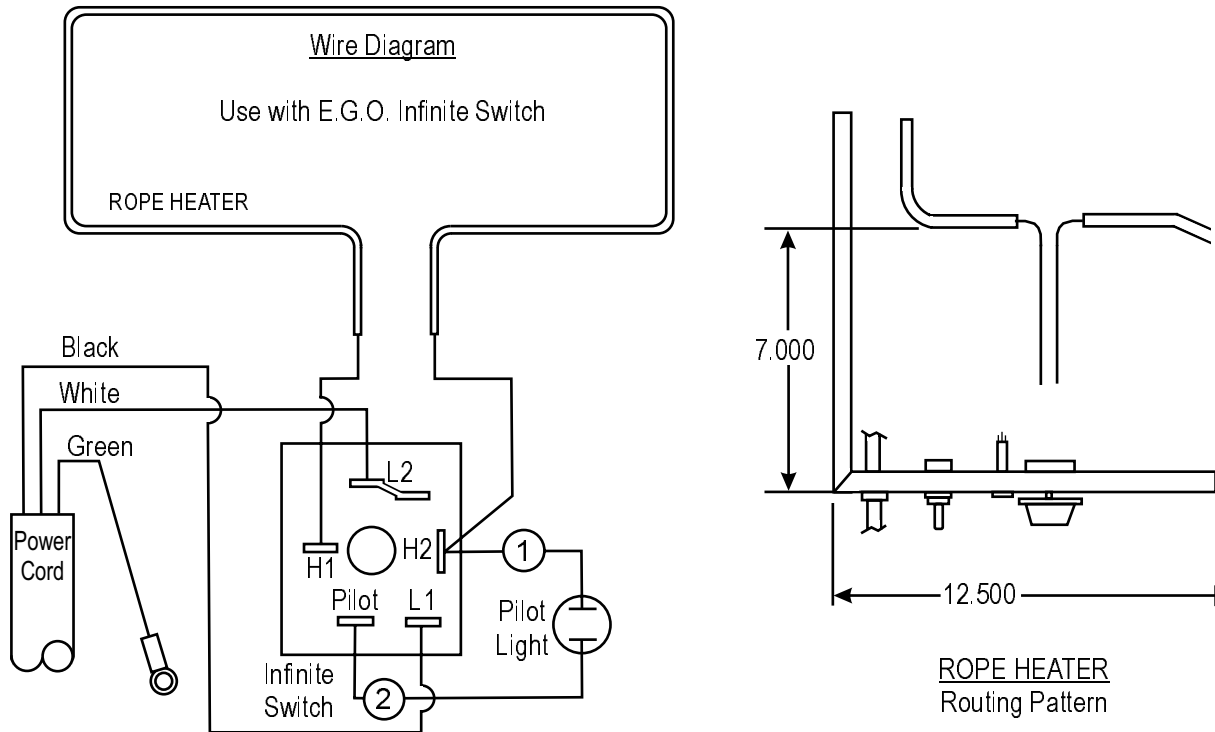

## PARTS LISTS & EXPLODED VIEW

120 VOLT UNITS				220 VOLT UNITS			
UNIT SIZE	ITEM	P/N	DESCRIPTION	UNIT SIZE	ITEM	P/N	DESCRIPTION
24"	1	8705610	KNOB	24"	1	8705610	KNOB
	2	1513903	INDICATOR LIGHT		2	1514000	INDICATOR LIGHT
	3	1532500	78" CORD SET 16/3AWG		3	1506600	78" CORD SET, EUR
	4	8967400	STRAIN RELIEF		4	8967400	STRAIN RELIEF
	5	1327900	INFINITE SWITCH		5	1327310	INFINITE SWITCH
	6	1431101	HEAT CABLE, 60", 120V		6	1431125	HEAT CABLE, 60", 240V
	7	2119200	BUMBER FEET		7	2119200	BUMBER FEET
36"	1	8705610	KNOB	36"	1	8705610	KNOB
	2	1513903	INDICATOR LIGHT		2	1514000	INDICATOR LIGHT
	3	1532500	78" CORD SET 16/3AWG		3	1506600	78" CORD SET, EUR
	4	8967400	STRAIN RELIEF		4	8967400	STRAIN RELIEF
	5	1327900	INFINITE SWITCH		5	1327310	INFINITE SWITCH
	6	1431102	HEAT CABLE, 84", 120V		6	1431126	HEAT CABLE, 84", 240V
	7	2119200	BUMBER FEET		7	2119200	BUMBER FEET
48"	1	8705610	KNOB	48"	1	8705610	KNOB
	2	1513903	INDICATOR LIGHT		2	1514000	INDICATOR LIGHT
	3	1532500	78" CORD SET 16/3AWG		3	1506600	78" CORD SET, EUR
	4	8967400	STRAIN RELIEF		4	8967400	STRAIN RELIEF
	5	1327900	INFINITE SWITCH		5	1327310	INFINITE SWITCH
	6	1431105	HEAT CABLE, 108", 120V		6	1431129	HEAT CABLE, 108", 240V
	7	2119200	BUMBER FEET		7	2119200	BUMBER FEET
60"	1	8705610	KNOB	60"	1	8705610	KNOB
	2	1513903	INDICATOR LIGHT		2	1514000	INDICATOR LIGHT
	3	1532500	78" CORD SET 16/3AWG		3	1506600	78" CORD SET, EUR
	4	8967400	STRAIN RELIEF		4	8967400	STRAIN RELIEF
	5	1327900	INFINITE SWITCH		5	1327310	INFINITE SWITCH
	6	1431108	HEAT CABLE, 136", 120V		6	1431132	HEAT CABLE, 136", 240V
	7	2119200	BUMBER FEET		7	2119200	BUMBER FEET
72"	1	8705610	KNOB	72"	1	8705610	KNOB
	2	1513903	INDICATOR LIGHT		2	1514000	INDICATOR LIGHT
	3	1532500	78" CORD SET 16/3AWG		3	1506600	78" CORD SET, EUR
	4	8967400	STRAIN RELIEF		4	8967400	STRAIN RELIEF
	5	1327900	INFINITE SWITCH		5	1327310	INFINITE SWITCH
	6	1431111	HEAT CABLE, 160", 120V		6	1431135	HEAT CABLE, 160", 240V
	7	2119200	BUMBER FEET		7	2119200	BUMBER FEET

208 VOLT UNITS				240 VOLT UNITS			
UNIT SIZE	ITEM	P/N	DESCRIPTION	UNIT SIZE	ITEM	P/N	DESCRIPTION
24"	1	8705610	KNOB	24"	1	8705610	KNOB
	2	1513903	INDICATOR LIGHT		2	1513903	INDICATOR LIGHT
	3	1547000	CORD SET 16/3		3	1547000	CORD SET, 16/3
	4	8967400	STRAIN RELIEF		4	8967400	STRAIN RELIEF
	5	1328200	INFINITE SWITCH		5	1328200	INFINITE SWITCH
	6	1431113	HEAT CABLE, 60", 208V		6	1431125	HEAT CABLE, 60", 240V
	7	2119200	BUMBER FEET		7	2119200	BUMBER FEET
36"	1	8705610	KNOB	36"	1	8705610	KNOB
	2	1513903	INDICATOR LIGHT		2	1513903	INDICATOR LIGHT
	3	1547000	CORD SET 16/3		3	1547000	CORD SET, 16/3
	4	8967400	STRAIN RELIEF		4	8967400	STRAIN RELIEF
	5	1328200	INFINITE SWITCH		5	1328200	INFINITE SWITCH
	6	1431114	HEAT CABLE, 84", 208V		6	1431128	HEAT CABLE, 84", 240V
	7	2119200	BUMBER FEET		7	2119200	BUMBER FEET
48"	1	8705610	KNOB	48"	1	8705610	KNOB
	2	1513903	INDICATOR LIGHT		2	1513903	INDICATOR LIGHT
	3	1547000	CORD SET 16/3		3	1547000	CORD SET, 16/3
	4	8967400	STRAIN RELIEF		4	8967400	STRAIN RELIEF
	5	1328200	INFINITE SWITCH		5	1328200	INFINITE SWITCH
	6	1431117	HEAT CABLE, 108", 208V		6	1431129	HEAT CABLE, 108", 240V
	7	2119200	BUMBER FEET		7	2119200	BUMBER FEET
60"	1	8705610	KNOB	60"	1	8705610	KNOB
	2	1513903	INDICATOR LIGHT		2	1513903	INDICATOR LIGHT
	3	1547000	CORD SET 16/3		3	1547000	CORD SET, 16/3
	4	8967400	STRAIN RELIEF		4	8967400	STRAIN RELIEF
	5	1328200	INFINITE SWITCH		5	1328200	INFINITE SWITCH
	6	1431120	HEAT CABLE, 136", 208V		6	1431132	HEAT CABLE, 136", 240V
	7	2119200	BUMBER FEET		7	2119200	BUMBER FEET
72"	1	8705610	KNOB	72"	1	8705610	KNOB
	2	1513903	INDICATOR LIGHT		2	1513903	INDICATOR LIGHT
	3	1547000	CORD SET 16/3		3	1547000	CORD SET, 16/3
	4	8967400	STRAIN RELIEF		4	8967400	STRAIN RELIEF
	5	1328200	INFINITE SWITCH		5	1328200	INFINITE SWITCH
	6	1431123	HEAT CABLE, 160", 208V		6	1431135	HEAT CABLE, 160", 240V
	7	2119200	BUMBER FEET		7	2119200	BUMBER FEET

EXPLODED VIEW

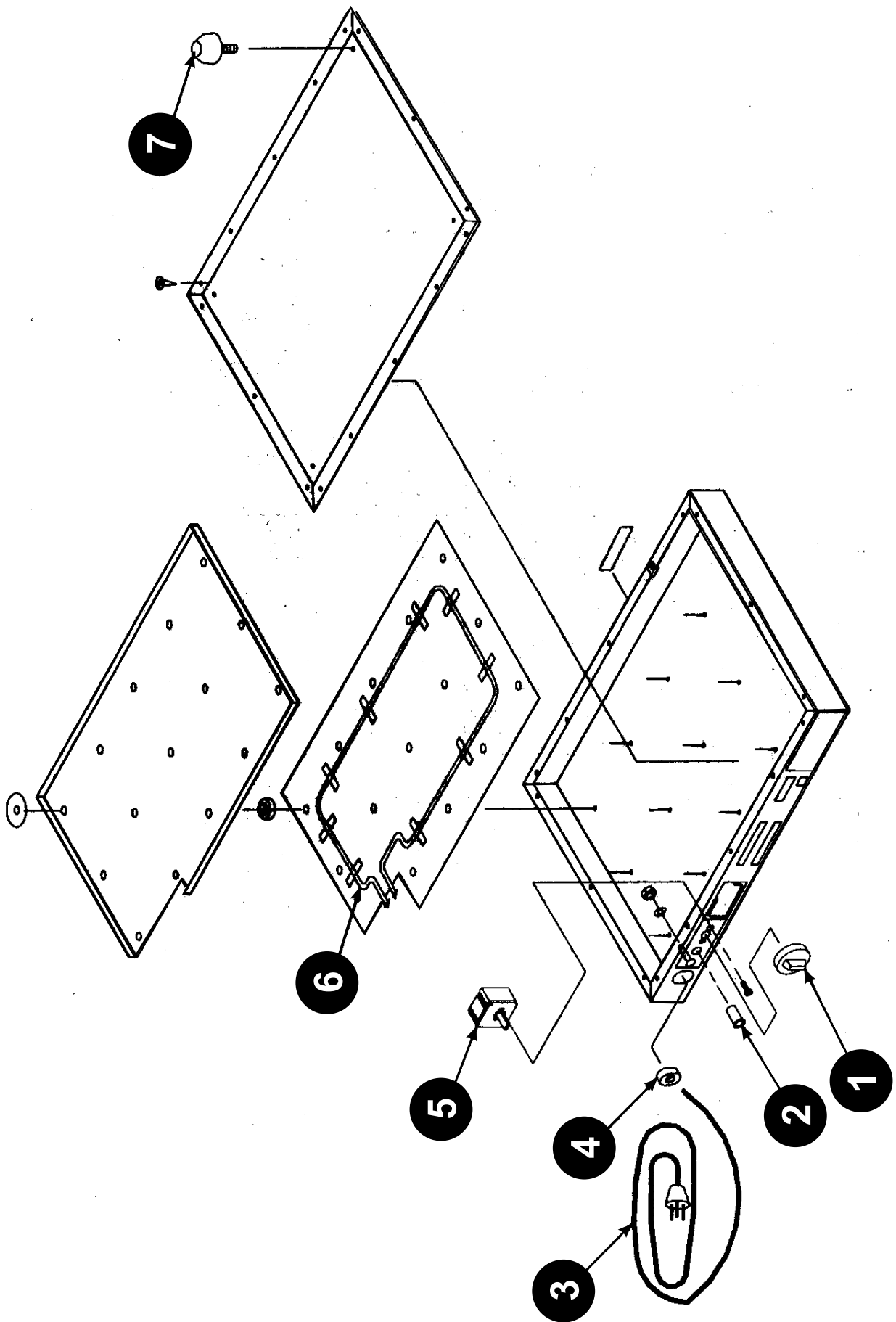



## APW WYOTT EQUIPMENT LIMITED WARRANTY

APW Wyott Foodservice Equipment Company warrants its equipment against defects in materials and workmanship, subject to the following conditions:

This warranty applies to the original owner only and is not assignable.

Should any product fail to function in its intended manner under normal use within the limits defined in this warranty, at the option of APW Wyott such product will be repaired or replaced by APW Wyott or its Authorized Service Agency. APW Wyott will only be responsible for charges incurred or service performed by its Authorized Service Agencies. The use of other than APW Wyott Authorized Service Agencies will void this warranty and APW Wyott will not be responsible for such work or any charges associated with same. The closest APW Wyott Authorized Service Agent must be used.

This warranty covers products shipped into the 48 contiguous United States, Hawaii, metropolitan areas of Alaska and Canada. There will be no labor coverage for equipment located on any island not connected by roadway to the mainland.

Warranty coverage on products used outside the 48 contiguous United States, Hawaii, and metropolitan areas of Alaska and Canada may vary. Contact the international APW Wyott distributor, dealer, or service agency for details.

### Time Period

One year for parts and one year for labor, effective from the date of purchase by the original owner. The Authorized Service Agency may, at their option, require proof of purchase. Parts replaced under this warranty are warranted for the un-expired portion of the original product warranty only.

### Exceptions

**\*Gas/Electric Cookline:** Models GCB, GCRB, GF, GGM, GGT, CHP-H, EF, EG, EHP. Three (3) Year Warranty on all component parts, except switches and thermostats. (2 additional years on parts only. No labor on second or third year.)

**\*Broiler Briquettes, Rock Grates, Cooking Grates, Burner Shields, Fireboxes:** 90 Day Material Only. No Labor.

**\*Heat Strips:** Models FD, FDL, FDD, FDDL. Two (2) Year Warranty on element only. No labor second year.

**\*Glass Windows, Doors, Seals, Rubber Seals, Light Bulbs:** 90 Day Material Only. No Labor.

In all cases, parts covered by extended warranty will be shipped FOB the factory after the first year.

### Portable Carry In Products

Equipment weighing over 70 pounds or permanently installed will be serviced on-site as per the terms of this warranty. Equipment weighing 70 pounds or under, and which is not permanently installed, i.e. with cord and plug, is considered portable and is subject to the following warranty handling limitations. If portable equipment fails to operate in its intended manner on the first day of connection, or use, at APW Wyott's option or its Authorized Service Agency, it will be serviced on site or replaced.

From day two through the conclusion of this warranty period, portable units must be taken to or sent prepaid to the APW Wyott Authorized Service Agency for in-warranty repairs. No mileage or travel charges are allowed on portable units after the first day of use. If the customer wants on-site service, they may receive same by paying the travel and mileage charges. Exceptions to this rule: (1) countertop warmers and cookers, which are covered under the Enhanced Warranty Program, and (2) toasters or rollergrills which have in store service.

### Exclusions

The following conditions are not covered by warranty:

\*Equipment failure relating to improper installation, improper utility connection or supply and problems due to ventilation.

\*Equipment that has not been properly maintained, calibration of controls, adjustments, damage from improper cleaning and water damage to controls.

\*Equipment that has not been used in an appropriate manner, or has been subject to misuse or misapplication, neglect, abuse, accident, alteration, negligence, damage during transit, delivery or installation, fire, flood, riot or act of god.

\*Equipment that has the model number or serial number removed or altered.

If the equipment has been changed, altered, modified or repaired by other than an Authorized Service Agency during or after the warranty period, then the manufacturer shall not be liable for any damages to any person or to any property, which may result from the use of the equipment thereafter.

This warranty does not cover services performed at overtime or premium labor rates. Should service be required at times which normally involve overtime or premium labor rates, the owner shall be charged for the difference between normal service rates and such premium rates. APW Wyott does not assume any liability for extended delays in replacing or repairing any items beyond its control.

In all cases, the use of other than APW Wyott Authorized OEM Replacement Parts will void this warranty.

This equipment is intended for commercial use only. Warranty is void if equipment is installed in other than commercial application.

### Water Quality Requirements

Water supply intended for a unit that has in excess of 3.0 grains of hardness per gallon (GPG) must be treated or softened before being used. Water containing over 3.0 GPG will decrease the efficiency and reduce the operation life of the unit.

**Note: Product failure caused by liming or sediment buildup is not covered under warranty.**

**"THE FOREGOING WARRANTY IS IN LIEU OF ANY AND ALL OTHER WARRANTIES EXPRESSED OR IMPLIED INCLUDING ANY IMPLIED WARRANTY OF MERCHANTABILITY OR FITNESS FOR PARTICULAR PURPOSES AND CONSTITUTES THE ENTIRE LIABILITY OF APW WYOTT. IN NO EVENT DOES THE LIMITED WARRANTY EXTEND BEYOND THE TERMS STATED HEREIN."**

9/05



---

Phone: +1 (307) 634-5801  
Fax: +1 (307) 637-8071  
Toll Free: +1 (800) 752-0863  
Website: [www.apwwyott.com](http://www.apwwyott.com)  
E-mail: [info@apwwyott.com](mailto:info@apwwyott.com)

**APW WYOTT**  
P.O. Box 1829  
Cheyenne, WY 82003