



COMMERCIAL INFRARED STRIP HEATER

Operating Instruction Manual



ESH-1

Optional Accessory

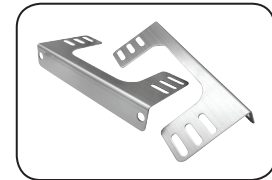

ESH-1-HB

ESH-1-HB Hanging Brackets for ESH-1



For California Customers
WARNING: Cancer and Reproductive Harm -
www.P65Warnings.ca.gov

Model	Voltage	Power	Amperage	Plug Type	Overall Dimensions			Product Weight
					Length	Depth	Height	
ESH-1	120V~ 50/60Hz	500W	4.2 A	NEMA 5-15P	26-1/8" (664mm)	14-1/4" (362mm)	18" (457mm)	6.61 lbs 3 kgs
							20-5/8" (524mm)	
							22-7/8" (581mm)	

BEFORE OPERATING ANY EQUIPMENT, READ AND FAMILIARIZE YOURSELF WITH THESE USE AND SAFETY INSTRUCTIONS

Congratulations on your purchase of this WINCO commercial equipment. WINCO takes pride in the quality of its products. When used as intended and with proper care and maintenance, you will experience years of reliable operation from this equipment. To ensure best results, it is important that you read and follow the instructions in this manual carefully. It's important to save these instructions for future reference.

Commercial Infrared Strip Heater

Important For Future Reference

Please complete this information and retain this manual for the life of the equipment. For Warranty Service and/or parts, this information is required.

Model Number

Serial Number

Date Purchased



WARNING: IMPROPER INSTALLATION, ADJUSTMENT, ALTERATION, SERVICE OR MAINTENANCE CAN CAUSE PROPERTY DAMAGE, INJURY, OR DEATH. READ THE INSTALLATION, OPERATION, AND MAINTENANCE INSTRUCTIONS THOROUGHLY BEFORE INSTALLING OR SERVICING THIS EQUIPMENT.

AVERTISSEMENT: TOUTE INSTALLATION, RÉGLAGE, MODIFICATION, RÉPARATION OU ENTRETIEN INCORRECT PEUT OCCASIONNER DES DOMMAGES MATÉRIELS, DES BLESSURES GRAVES OU LA MORT. LIRE LES INTRUCTIONS D'INSTALLATION, D'UTILISATION ET D'ENTRETIEN ATTENTIVEMENT AVANT D'INSTALLER OU DE RÉPARER CET APPAREIL.



CAUTION: THESE MODELS ARE DESIGNED, BUILT, AND SOLD FOR COMMERCIAL USE ONLY. IF THESE MODELS ARE POSITIONED SO THE GENERAL PUBLIC CAN USE THE EQUIPMENT, MAKE SURE THAT CAUTION SIGNS, WARNINGS, AND OPERATING INSTRUCTIONS ARE CLEARLY POSTED NEAR EACH UNIT SO THAT ANYONE USING THE EQUIPMENT WILL USE IT CORRECTLY AND NOT INJURE THEMSELVES OR HARM THE EQUIPMENT.

ATTENTION: CES MODÈLES SONT CONÇUS, FABRIQUÉS, ET VENDUS POUR UN USAGE COMMERCIAL SEULEMENT. SI CES MODÈLES SONT PLACÉS POUR QUE LE GRAND PUBLIC PUISSE LES UTILISER, ASSUREZ-VOUS QUE LES CONSIGNES D'ATTENTION, D'AVERTISSEMENT, ET LES INSTRUCTIONS D'UTILISATION SOIENT CLAIREMENT AFFICHÉES PRÈS DE CHAQUE UNITÉ DE SORTE QUE N'IMPORTE QUEL UTILISATEUR DE L'APPAREIL L'EMPLOIE CORRECTEMENT ET NE SE BLESSE PAS OU N'ENDOMMAGE PAS L'APPAREIL.



WARNING: A FACTORY AUTHORIZED SERVICE PROVIDER SHOULD HANDLE ALL MAINTENANCE AND REPAIR. BEFORE DOING ANY MAINTENANCE OR REPAIR, FOLLOW SERVICE SET UP ARRANGEMENT ON PAGE 11.

AVERTISSEMENT: UN TECHNICIEN AUTORISÉ PAR L'USINE DEVRA EFFECTUER TOUT L'ENTRETIEN ET LES RÉPARATIONS. AVANT DE FAIRE TOUT ENTRETIEN OU RÉPARATION, VEUILLEZ CONTACTER WINCO.



Introduction

Congratulations on the purchase of WINCO® equipment. Please take time to carefully read through this manual to ensure the equipment is operated and maintained properly, to ensure the best possible performance from the product for many years. Winco will not accept liability for the following if:

- The instructions in this manual have not been followed correctly.
- Non-authorized personnel have tampered with the equipment.
- Non-original spare parts are used.
- The equipment has not been handled and cleaned correctly.
- There is any use damage to the unit.

Immediately Inspect for Shipping Damage

All containers should be examined for damage before and during unloading. The freight carrier has assumed responsibility for its safe transit and delivery. If equipment is received damaged, either apparent or concealed, a claim must be made with the delivering carrier.

- A. Apparent damage or loss must be noted on the freight bill at the time of delivery. It must then be signed by the carrier representative (Driver). If this is not done, the carrier may refuse the claim. The carrier can supply the necessary forms.
- B. If concealed damage or loss is not apparent until after equipment is uncrated, a request for inspection must be made to the carrier within 15 days. The carrier should arrange an inspection. Be certain to keep all contents and packaging material.

Commercial Infrared Strip Heater

Table of Contents

Specifications	1
Warnings	2
Introduction	2
Table of Contents	3
Packaging	3
Important Safeguards.....	4
Operation	6
Cleaning, Care & Maintenance	6
Safety	7
Troubleshooting	7
Service & Repair	7
Exploded View	8
Parts List.....	8
Electrical Diagram	9
Limited Warranty	10

Package Contents

All units come with an Operating Instruction Manual and the following:

- Electric Strip Heater
- Adjustable Stand

WINCO prides itself on quality and service, ensuring that at the time of packing, all products are supplied fully functional and free of damage. Should you find any damage as result of freight, please contact your WINCO dealer immediately.

Unpacking the Equipment

DISPOSE OF ALL PACKAGING MATERIALS IN AN ENVIRONMENTALLY RESPONSIBLE MANNER.

1. Remove all packing materials and tape, as well as any protective plastic and cardboard, from the unit.
2. Clean any glue residue left over from the plastic or tape.
3. Place the unit in the desired position and height.

SAVE THE ORIGINAL BOX AND PACKAGING FOR USE IN PACKAGING AND SHIPPING THE EQUIPMENT IF SERVICES ARE NEEDED.

Installation and start-up must be performed by a qualified installer who has thoroughly read, understands and follows these instructions.

Please keep this manual in a safe place for future use!

NOTE

Please remember that this manual and the warning labels do not replace the need to be alert, to properly train and supervise operators, and to use common sense when using this equipment.

Important Safeguards

To ensure safe installation and operation, please carefully read and understand the following statements.

Unless the operator is adequately trained and supervised there is a possibility of serious injury. Owners of this equipment bear the responsibility to make certain that this equipment is used properly and safely, and to strictly follow all of the instructions contained in this manual and the requirements of local, state or federal law.



Owners should not permit anyone to touch this equipment unless they are over 18 years old, are adequately trained and supervised, and have read and understood this manual.

Owners should also ensure that no customers, visitors or other unauthorized personnel come in contact with this equipment. It is the responsibility of the owner and the operator to remain alert to any hazards posed by the function of this equipment.

If there is ever uncertainty about a particular task or the proper method of operating this equipment, ask an experienced supervisor.

Warnings

This manual contains a number of precautions to follow to help promote safe use of this equipment.

 HOT	WARNING  AVERTISSEMENT
	DO NOT TOUCH HOT LIQUID OR HEATING SURFACES WHILE THE UNIT IS HEATING UP OR OPERATING.
	Ne touchez pas le liquide chaud ou les surfaces de chauffage lorsque l'appareil chauffe ou en fonctionnement.

FOR YOUR SAFETY

Do not store or use gasoline or other flammable vapors and liquids in the vicinity of this or any other appliance.

ESURE DE SECURITE

Ne pas entreposer ni utiliser d'essence ni autres vapeurs ou liquides inflammables a proximite de cet appareil ou de tout autre appareil!

WARNING

Improper installation, adjustment, alteration, service or maintenance can cause property damage, injury or death. Read these installation, operating and maintenance instructions thoroughly before installing or servicing this equipment.

AVERTISSEMENT

L'installation, le réglage, la modification, la réparation ou l'entretien incorrect de cet appareil peut causer des dommages matériels, des blessures ou la mort. Lire attentivement les instructions d'installation, de fonctionnement et d'entretien avant de procéder a son installation ou entretien.

TO PURCHASER

Contact your local gas supplier and ask for instructions in the event the user smells gas. This information should be posted in a prominent location.

À L'ACHETEUR

Communiquez avec votre distributeur de gaz et informez vous quant aux procédés a suivre si vous détectez une odeur de gaz. Cette information doit être affichée a un endroit facile d'accès et très visible.

Warning

Improper installation, adjustment, alteration, service or maintenance can cause property damage, injury or death. Read the installation, operation, and maintenance instructions thoroughly before installing or servicing this equipment.

Caution Before Using Appliance

1. Read all instructions carefully. Do not use this appliance for anything other than its intended use.
2. Do not touch surfaces that may be hot - be sure to always use handles or knobs.
3. Unplug from outlet when not in use, prior to installing or removing parts, and before cleaning. Allow for the device to cool first.
4. To protect against the risk of electrical shock, do not immerse the appliance, cord or plug in water or other liquids.

WARNING ⚠️ AVERTISSEMENT	
	Electrical Shock Hazard Keep water and other liquids from entering the inside of the unit. Liquid inside the unit could cause an electrical shock.
	Risque de choc électrique Conserver l'eau et d'autres liquides de pénétrer à l'intérieur de l'appareil. Liquide à l'intérieur de l'appareil pourrait provoquer un choc électrique.
	Do not spray water or cleaning products. Liquid could contact the electrical components and cause a short circuit or an electrical shock. Do not use unit if power cord is damaged or has been modified.
	Ne pas pulvériser de l'eau ou des produits de nettoyage. Le liquide pourrait contacter avec les composants électriques et causer un court-circuit ou un choc électrique. Ne pas utiliser l'appareil si le cordon d'alimentation est endommagé ou a été modifié.

5. DO NOT operate this device or any other electrical equipment with a damaged cord or plug, or after the unit malfunctions, is dropped or damaged in any manner. Return to the nearest WINCO Authorized Service Center for examination, repair, and / or adjustment.
6. The use of accessory attachments not recommended by WINCO may cause fire, electric shock or injury.
7. Not intended for outdoor installation.
8. DO NOT let the cord hang over the edge of a table or counter, or touch hot surfaces.
9. DO NOT place on or near a hot gas or electric burner or in a heated oven.
10. This appliance should always be on a stable and steady countertop or table when legs are in use.

WARNING ⚠️ AVERTISSEMENT	
	Fire Hazard. Correct installation precautions, procedures and regulations must be followed. Operation and safety training is necessary for all users of this equipment.
	Risque d'incendie La surchauffe des vapeurs d'huile ou de l'huile peut s'enflammer et provoquer un incendie. Surveillez la température, la qualité et le niveau d'huile. Utilisez et entretenez le système d'élimination des vapeurs d'huile.

11. This appliance is not intended for use by individuals (including children) with reduced or impaired physical, sensory, or mental capabilities, or lack of experience or knowledge, unless they have been given proper supervision or instruction concerning the use of this appliance by a person responsible for their safety.
12. Children should be supervised at all times to ensure that they do not play with this appliance.
13. Clean the unit with caution – do not clean when unit is plugged in or when hot.
14. Do not place metal objects such as knives, forks or spoons in the heater as it may damage the unit, and may also result in injury.
15. Do not store any item on top of this unit when in operation.
16. Never place materials such as paper, cardboard, plastic, etc. on or under this unit.

Proper Grounding · Mise à la terre correcte

This machine is provided with a three-pronged grounding plug. The outlet to which this plug is connected must be properly grounded. If the receptacle is not the proper grounding type, contact an electrician. DO NOT, under any circumstances, cut or remove the third ground prong from the power cord or use any adapter plug.

Cette machine est équipée d'une fiche à trois broches. La prise sur laquelle cette fiche est branchée doit être correctement mise à la terre. Si la prise n'est pas le type de mise à la terre, contactez avec un électricien. NE PAS, en aucun cas couper ou enlever la troisième broche de terre à partir du cordon d'alimentation ou utiliser un adaptateur.

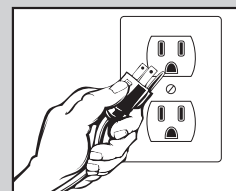

**USE A GROUNDED OUTLET
DO NOT ADD AN ADAPTOR
TO THE PLUG**

**UTILISER UNE PRISE AVEC MISE
À LA TERRE NE PAS AJOUTER UN
ADAPTEUR SUR LA FICHE**

ESH-1

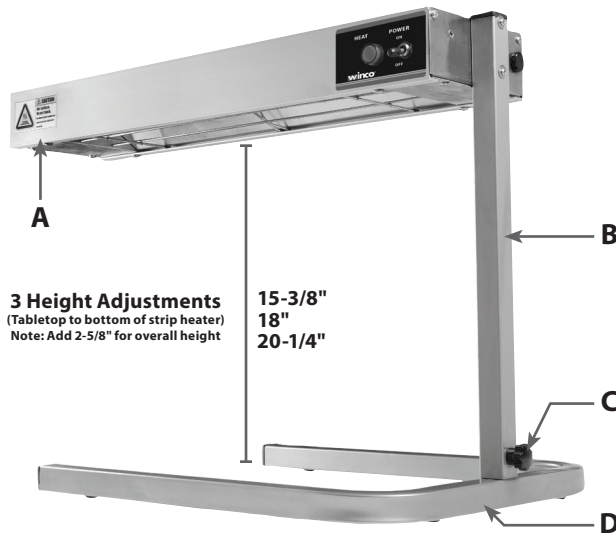

- A. Strip Heater
B. Support
C. Locking Screw
D. Stand

3 Height Adjustments
(Tabletop to bottom of strip heater)
Note: Add 2-5/8" for overall height

15-3/8"
18"
20-1/4"

Preparation

1. Set unit on a flat surface.
2. If unit fails to work properly when first operated, contact Winco customer service at EquipService@wincous.com or call: 973-295-3899.

Operation

1. Slide the support onto the stand and secure with the locking screw.
Note: There are 3 heights available.
2. Route the power supply away from the heat source, and secure power cord safely as required. It is recommended ziptieing them to the stand or other nearby supports to a receptacle.
3. Plug power cord into a receptacle.
4. Turn on the unit via the power switch.
5. Turn off unit when not in use.

CAUTION:

Do not clean when plugged in - HOT!
Unplug the unit and wait for unit to cool before cleaning.

Cleaning & Maintenance

Before using this equipment it must be cleaned and dried thoroughly. Clean all surfaces before use. Failure to clean surfaces before using the unit could cause food contamination.

Always unplug the unit after every use and before cleaning. Unplug the unit when not in operation.

- Allow unit to cool completely before cleaning.
- Clean main body with a damp cloth and degreaser solution if desired.
- Allow to dry before turning the unit back on.
- Do not immerse the device completely in water to clean. The appliance should also NOT be cleaned with a water jet.

NOTE:

Proper cleaning instructions must be followed; otherwise, operation of the unit may be seriously impaired. Do not wash parts in an automatic dishwasher.

WINCO authorized service personnel must perform any other servicing.

Safety

SAFETY PRECAUTIONS

Before installing and operating this equipment be sure everyone involved in its operation are fully trained and aware of all precautions. Accidents and problems can result from a failure to follow fundamental rules and precautions.

- A WINCO® Approved Recommended Qualified Service Technician should carry out repairs if necessary. Do not remove any components or service panels on this product.
- Allow the unit to cool down after use before dismantling for cleaning; **the unit will be too hot to handle immediately after use.**
- Before cleaning, switch power OFF and disconnect power cord from the outlet.
- **Do not immerse unit in water or use hose to clean.**
Ne jamais immerger l'appareil dans l'eau ni utilisez un jet d'eau pour le nettoyer.
- If the power cord is damaged, it must be replaced by a WINCO® Approved Recommended Qualified Service Technician in order to avoid a hazard.

Troubleshooting

If your WINCO Infrared Strip Heater does not operate, please check the following prior to placing a service call.

ISSUE	MIGHT BE CAUSED BY	RECOMMENDED SOLUTION
The unit is not turning on	Power supply cord or circuit breaker.	Check that the power supply cord is correctly plugged into the outlet and the circuit breaker is not tripped.
	Switches have not been turned on	Check that the switch is in the ON position.
	Plug/cord or external wiring is damaged	Remove and replace damaged plug and wiring <i>- Replacement must be done by an authorized service provider.</i>
	Internal wiring fault	
The unit is not heating up	Indicator light does not come on	See "unit is not turning on" section.
	Faulty heating element	Remove and replace faulty wiring - <i>Replacement must be done by an authorized service provider.</i>
Heating light does not come but the unit does heat up	Faulty indicator light	Remove and replace heating light - <i>Replacement must be done by an authorized service provider.</i>

Service and Repair

THIS EQUIPMENT MUST ONLY BE SERVICED BY AN AUTHORIZED AGENT.

NOTE

Parts protected by the manufacturer or its agent are not to be adjusted by the installer unless the installer is an authorized service agent.

If you have any questions or problems DO NOT send unit to WINCO® without first contacting our customer service department.

See "Limited Warranty" section on page 10 for details.

Exploded Views

MODEL: ESH-1

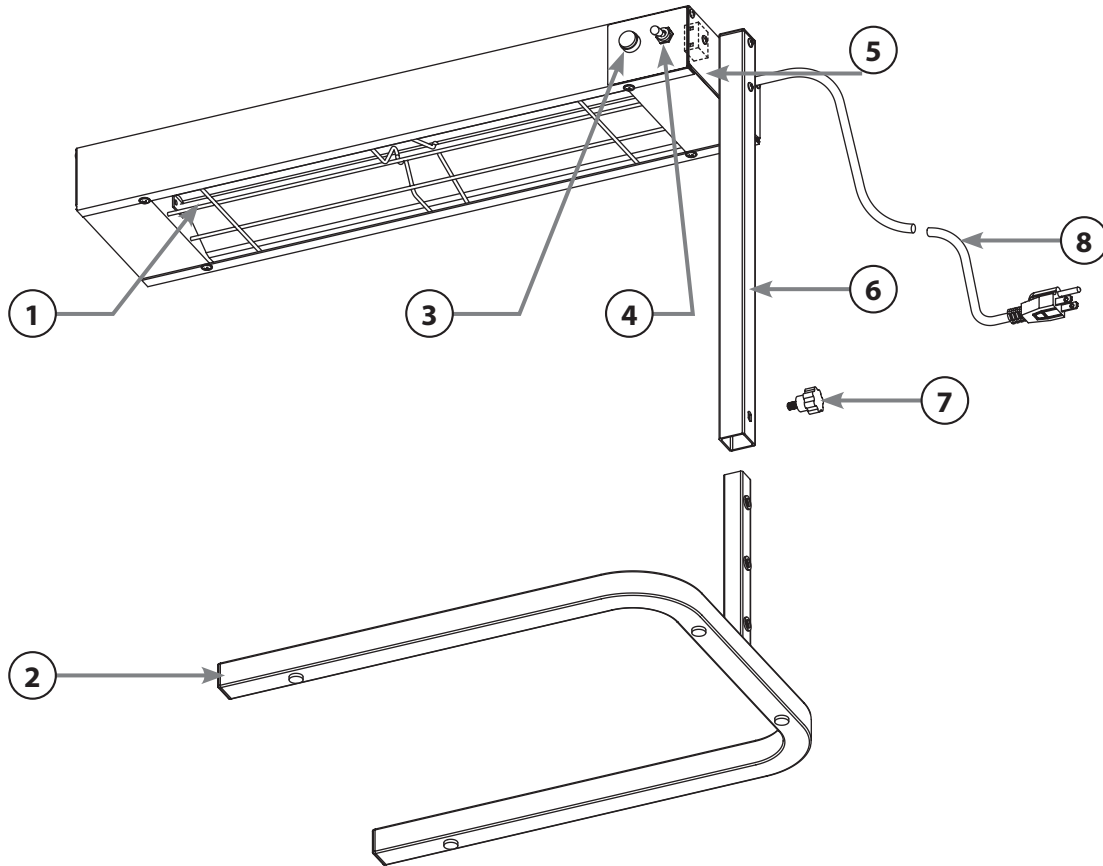

Parts List

MODEL: ESH-1

#	Description	Part #	QTY
1	Heating Elements for ESH-1 and ESH-24	ESH-P2	1
2	Stand for ESH-1	ESH-1-ST	1
3	Indicator Light	FWS500-P10	1
4	Toggle Switch	ESH-P1	1
5	Terminal Block for ESH-Series	ESW66-P40	1
6	Support for ESH-1	ESH-1-SP	1
7	Height Adjustment Knob for ESH-1	ESH-1-KB	1
8	Power Cord for ESH-1	ESH-P8	1
	OPTIONAL Hanging Brackets for ESH-1	ESH-1-HB	

Please contact factory for special order parts not listed.

Electrical Circuit Diagram

MODEL: ESH-1

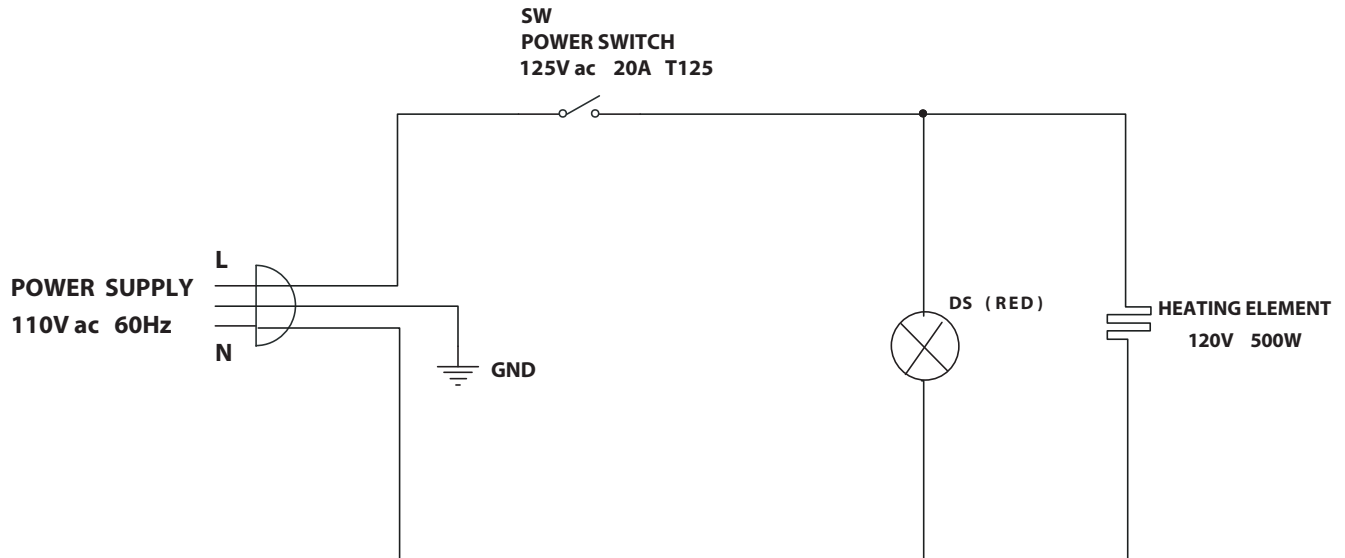

This circuit diagram has been provided to assist qualified electricians; only WINCO service agents or qualified electricians should carry out repairs if required.
Do not remove any components or service panels on this product.

Limited Warranty

WINCO® warrants to the original purchaser of new equipment that said equipment, when installed in accordance with our instructions within North America and subjected to normal use, is free from defects in material or workmanship for a period of 1 year. The labor warranty is one year from original installation or 18 months from actual factory shipment date, whichever date occurs first.

THIS WARRANTY IS IN LIEU OF ALL OTHER WARRANTIES, WHETHER EXPRESSED OR IMPLIED. WINCO EXPRESSLY DISCLAIMS ANY IMPLIED WARRANTY OF MERCHANTABILITY OR EXPRESSED OR IMPLIED WARRANTY OF FITNESS FOR A PARTICULAR PURPOSE.

WINCO'S OBLIGATION AND LIABILITY UNDER THIS WARRANTY IS EXPRESSLY LIMITED TO REPAIRING AND REPLACING EQUIPMENT THAT PROVES TO BE DEFECTIVE IN MATERIAL OR WORKMANSHIP WITHIN THE APPLICABLE WARRANTY PERIOD.

IN NO EVENT SHALL WINCO BE LIABLE FOR INCIDENTAL OR CONSEQUENTIAL DAMAGES TO BUYER OR ANY THIRD PARTY, INCLUDING, WITHOUT LIMITATION, LOSS OF PROPERTY, PERSONAL INJURY, LOSS OF BUSINESS OR PROFITS OR OTHER ECONOMIC LOSSES, OR STATUTORY OR EXEMPLARY DAMAGES, WHETHER IN NEGLIGENCE, WARRANTY, STRICT LIABILITY, OR OTHERWISE.

This warranty is given only to the first purchaser from a retail dealer. No warranty is given to subsequent transferees.

Warranty does not cover product failures caused by: failure to maintain, neglect, abuse, damage due to excess water, fire, normal wear, improper set up and use. Periodic maintenance is not covered.

This warranty is not in force until such time as a properly completed and digitally signed Installation/Warranty Registration has been received by WINCO within 30 days from the date of installation.

WARRANTY SERVICE

To initiate warranty service contact: **EquipService@wincous.com**
or call: 973-295-3899

DO NOT send unit to WINCO® without first contacting our customer service department.

REGISTER ONLINE AT:

<http://www.wincous.com>

Proof of purchase is required to extend warranty more than 1 year from date of shipment from the factory.

THE FOREGOING WARRANTY PROVISIONS ARE A COMPLETE AND EXCLUSIVE STATEMENT BETWEEN THE BUYER AND SELLER. WINCO® NEITHER ASSUMES NOR AUTHORIZES ANY PERSONS TO ASSUME FOR IT ANY OTHER OBLIGATION OR LIABILITY IN CONNECTION WITH SAID EQUIPMENT.

Examples of items not covered under warranty, but not limited to just these items:

1. Natural disasters (ie: earthquakes, tornadoes, hurricanes, etc.), fire, water damage, burglary, accident, theft.
2. Freight damage.
3. Improper installation or alteration of equipment.
4. Use of generic or after-market parts.
5. Repairs made by anyone other than a WINCO® designated service provider.
6. Lubrication.
7. Expendable wear parts, adjustable feet, blown fuses, lamps, etc.
8. Cleaning of equipment.
9. Misuse or abuse.

Please keep this manual in a safe place for future use!



Model: ESH-1

www.wincous.com