

# ACCELMIX™

# winco®

## COMMERCIAL BLENDER WITH PADDLE CONTROLS

### Operating Instruction Manual



Model	Voltage ~ Hz	Power	Amperage	Power Cord	Volume	Overall Height		
XLB-1000	120V ~ 60Hz	1450W	12.1A	15A	68oz (2 L)	20" (508mm)		
				Plug Type		Base Dimensions		
				NEMA 5-15P		Width	Depth	Height
						9" (228mm)	10" (254mm)	8-1/2" (216mm)

#### BEFORE OPERATING ANY EQUIPMENT, READ AND FAMILIARIZE YOURSELF WITH THESE USE AND SAFETY INSTRUCTIONS

Congratulations on your purchase of this ACCELMIX™ commercial blender. When used as intended, and with proper care and maintenance, you are sure to experience years of reliable operation from this equipment. To ensure best results, it is important that you read and follow the instructions in this manual carefully. **It is important to keep these instructions in a safe place for future reference.**

## Commercial Blender with Paddle Controls

### Important For Future Reference

Please complete the following information and retain this manual for the life of the product. This information is required for Warranty Service and/or parts. Please see Page 10 for more information on your Warranty and How to Register.

**XLB-1000**

Model Number

Serial Number

Date Purchased



**WARNING: IMPROPER INSTALLATION, ADJUSTMENT, ALTERATION, SERVICE OR MAINTENANCE CAN CAUSE PROPERTY DAMAGE, INJURY, OR DEATH. READ THE INSTALLATION, OPERATION, AND MAINTENANCE INSTRUCTIONS THOROUGHLY BEFORE INSTALLING OR SERVICING THIS EQUIPMENT.**

**AVERTISSEMENT: TOUTE INSTALLATION, RÉGLAGE, MODIFICATION, RÉPARATION OU ENTRETIEN INCORRECT PEUT OCCASIONNER DES DOMMAGES MATÉRIELS, DES BLESSURES GRAVES OU LA MORT. LIRE LES INTRUCTIONS D'INSTALLATION, D'UTILISATION ET D'ENTRETIEN ATTENTIVEMENT AVANT D'INSTALLER OU DE RÉPARER CET APPAREIL.**



**CAUTION: THESE MODELS ARE DESIGNED, BUILT, AND SOLD FOR COMMERCIAL USE ONLY. IF THESE MODELS ARE POSITIONED SO THE GENERAL PUBLIC CAN USE THE EQUIPMENT, MAKE SURE THAT CAUTION SIGNS, WARNINGS, AND OPERATING INSTRUCTIONS ARE CLEARLY POSTED NEAR EACH UNIT SO THAT ANYONE USING THE EQUIPMENT WILL USE IT CORRECTLY AND NOT INJURE THEMSELVES OR HARM THE EQUIPMENT.**

**ATTENTION: CES MODÈLES SONT CONÇUS, FABRIQUÉS, ET VENDUS POUR UN USAGE COMMERCIAL SEULEMENT. SI CES MODÈLES SONT PLACÉS POUR QUE LE GRAND PUBLIC PUISSE LES UTILISER, ASSUREZ-VOUS QUE LES CONSIGNES D'ATTENTION, D'AVERTISSEMENT, ET LES INSTRUCTIONS D'UTILISATION SOIENT CLAIEMENT AFFICHÉES PRÈS DE CHAQUE UNITÉ DE SORTE QUE N'IMPORTE QUEL UTILISATEUR DE L'APPAREIL L'EMPLOIE CORRECTEMENT ET NE SE BLESSE PAS OU N'ENDOMMAGE PAS L'APPAREIL.**



**WARNING: A FACTORY AUTHORIZED SERVICE PROVIDER SHOULD HANDLE ALL MAINTENANCE AND REPAIR. BEFORE DOING ANY MAINTENANCE OR REPAIR, FOLLOW SERVICE SET UP ARRANGEMENT ON PAGE 10.**

**AVERTISSEMENT: UN TECHNICIEN AUTORISÉ PAR L'USINE DEVRA EFFECTUER TOUT L'ENTRETIEN ET LES RÉPARATIONS. AVANT DE FAIRE TOUT ENTRETIEN OU RÉPARATION, VEUILLEZ CONTACTER WINCO.**



### Introduction

Congratulations on the purchase of your ACCELMIX™ machine. Please take the time to carefully read through this manual to ensure the machine is operated and maintained properly, to ensure the best possible performance from this product for many years.

WINCO will not accept liability if:

- The instructions in this manual have not been followed correctly.
- Non-authorized personnel have tampered with the machine.
- Non-original spare parts are used.
- The machine has not been handled and cleaned correctly.
- There is any use damage to the unit.

## Commercial Blender with Paddle Controls

### Table of Contents

---

Specifications.....	1
Warnings .....	2
Introduction .....	2
Table of Contents .....	3
Packaging .....	3
Important Safeguards .....	4
Operation .....	6
Cleaning, Care & Maintenance .....	6
Safety & Troubleshooting .....	7
Exploded View .....	8
Parts List .....	9
Limited Warranty .....	10

### Package Contents

---

All units come with an Operating Instruction Manual and the following:

- XLB-1000 Commercial Blender Base
- 68 oz. (2 L) Blender Container and Lid
- Tamper

WINCO® prides itself on quality and service, ensuring that at the time of packing, all products are supplied fully functional and free of damage. Should you find any damage as result of freight, please contact your WINCO® dealer immediately.

### Function and Purpose

---

This unit is intended to be used in commercial food-service operations only. It is not intended for household, industrial or laboratory use.

### NOTE

---

***Please remember that this manual and the warning labels do not replace the need to be alert, to properly train and supervise operators, and to use common sense when using this equipment.***

### Unpacking the Equipment

---

#### **DISPOSE OF ALL PACKAGING MATERIALS IN AN ENVIRONMENTALLY RESPONSIBLE MANNER.**

1. Remove all packing materials and tape, as well as any protective plastic and cardboard from the unit.
2. Clean any glue residue left over from the plastic or tape.
3. Place the unit in the desired position and height.

**SAVE THE ORIGINAL BOX AND PACKAGING FOR USE IN PACKAGING AND SHIPPING THE EQUIPMENT IF SERVICES ARE NEEDED.**

## Important Safeguards

To ensure safe installation and operation, please carefully read and understand the following statements.

Unless the operator is adequately trained and supervised there is a possibility of serious injury. Owners of this equipment bear the responsibility to make certain that this equipment is used properly and safely, and to strictly follow all of the instructions contained in this manual and the requirements of local, state or federal law.



Owners should not permit anyone to touch this equipment unless they are over 18 years old, are adequately trained and supervised, and have read and understood this manual.



Owners should also ensure that no customers, visitors or other unauthorized personnel come in contact with this equipment. It is the responsibility of the owner and the operator to remain alert to any hazards posed by the function of this equipment.

If there is ever uncertainty about a particular task or the proper method of operating this equipment, ask an experienced supervisor.

## Safety Warnings

This manual contains a number of precautions to follow to help promote safe use of this equipment.

	<b>WARNING</b>  <b>AVERTISSEMENT</b>	
	USE CAUTION WHEN TOUCHING THE UNIT.	NE TOUCHEZ PAS L'UNITÉ CHAUDE.
<b>HOT</b>		

	<b>WARNING</b>  <b>AVERTISSEMENT</b>	
	USE CAUTION WHEN HANDLING THE UNIT.	MANIPULER L'APPAREIL AVEC PRUDENCE.
<b>CUT</b>		

### FOR YOUR SAFETY

Do not store or use gasoline or other flammable vapors and liquids in the vicinity of this or any other appliance.

### ESURE DE SECURITE

Ne pas entreposer ni utiliser de'essence ni autres vapeurs ou liquides inflammables a proximite de cet appareil ou de tout autre appareil!

### WARNING

Improper installation, adjustment, alteration, service or maintenance can cause property damage, injury or death.

Read these installation, operating and maintenance instructions thoroughly before installing or servicing this equipment.

### AVERTISSEMENT

L'installation, le réglage, la modification, la réparation ou l'entretien incorrect de cet appareil peut causer des dommages matériels, des blessures ou la mort. Lire attentivement les instructions d'installation, de fonctionnement et d'entretien avant de procéder a son installation ou entretien.

## Warning

Improper installation, adjustment, alteration, service, or maintenance can cause property damage, injury, or death. Read the installation, operation, and maintenance instructions thoroughly before installing or servicing this equipment.

## Caution Before Using Appliance

1. Read all instructions carefully. Do not use this appliance for anything other than its intended use.
2. Unplug from outlet when not in use, prior to installing or removing parts, and before cleaning. Allow for the device blades/gear to stop rotating.
3. To protect against the risk of electrical shock, do not immerse the appliance, cord or plug in water or other liquids.

<b>WARNING ⚠️ AVERTISSEMENT</b>	
	<b>Electrical Shock Hazard</b> Keep water and other liquids from entering the inside of the unit. Liquid inside the unit could cause an electrical shock.
	<b>Risque de choc électrique</b> Conserver l'eau et d'autres liquides de pénétrer à l'intérieur de l'appareil. Liquide à l'intérieur de l'appareil pourrait provoquer un choc électrique.
	Do not spray water or cleaning products. Liquid could contact the electrical components and cause a short circuit or an electrical shock. Do not use unit if power cord is damaged or has been modified.
	Ne pas pulvériser de l'eau ou des produits de nettoyage. Le liquide pourrait contacter avec les composants électriques et causer un court-circuit ou un choc électrique. Ne pas utiliser l'appareil si le cordon d'alimentation est endommagé, ou a été modifié.

4. Avoid contact with moving parts.
5. Do not operate this device or any other electrical equipment with a damaged cord or plug, or after the unit malfunctions, or is dropped or damaged in any manner. Return to the nearest WINCO® Authorized Service Center for examination, repair, and / or adjustment.

### Proper Grounding · Mise à la terre correcte

This machine is provided with a three-pronged grounding plug. The outlet to which this plug is connected must be properly grounded. If the receptacle is not the proper grounding type, contact an electrician. DO NOT, under any circumstances, cut or remove the third ground prong from the power cord or use any adapter plug.

*Cette machine est équipée d'une fiche à trois broches. La prise sur laquelle cette fiche est branchée doit être correctement mise à la terre. Si la prise n'est pas le type de mise à la terre, contactez avec un électricien. NE PAS, en aucun cas couper ou enlever la troisième broche de terre à partir du cordon d'alimentation ou utiliser un adaptateur.*

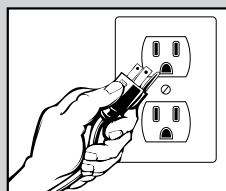

**USE A GROUNDED OUTLET  
DO NOT ADD AN ADAPTOR  
TO THE PLUG**

**UTILISER UNE PRISE AVEC MISE  
À LA TERRE NE PAS AJOUTER UN  
ADAPTEUR SUR LA FICHE**

<b>WARNING ⚠️ AVERTISSEMENT</b>	
	<b>Fire Hazard.</b> Correct installation precautions, procedures and regulations must be followed. Operation and safety training is necessary for all users of this equipment.
	<b>Risque d'incendie</b> La surchauffe des vapeurs d'huile ou de l'huile peut s'enflammer et provoquer un incendie. Surveillez la température, la qualité et le niveau d'huile. Utilisez et entretenez le système d'élimination des vapeurs d'huile.

6. The use of accessory attachments not recommended by WINCO may cause fire, electric shock, or injury.
7. Not intended for outdoor installation.
8. Do not let the cord hang over the edge of a table or counter, or touch hot surfaces.
9. Do not place on or near a heat source.
10. Do not overload the unit.
11. This appliance should always be on a stable and steady countertop or table.
12. This appliance is not intended for use by individuals (including children) with reduced or impaired physical, sensory, or mental capabilities, or lack of experience or knowledge, unless they have been given proper supervision or instruction concerning the use of this appliance by a person responsible for their safety.
13. Children should be supervised at all times to ensure that they do not play with this appliance.
14. Do not place metal objects such as knives, forks or spoons in blender container as they can damage the blender and/or cause serious injury.
15. Ensure proper grounding: Use of attached 3-prong plug.
16. Do not try to override the safety switch on the blender base for the blender container. This may damage the switch and cause injury.
17. Do not try to stop the center rotating gear on the blender base or prevent it from spinning. This may cause damage to the unit and/or injury.

## Operation

---

1. Make sure power is off and speed dial is turned to low.
2. Plug in power cord attached to the base into an electrical outlet.
3. Secure the container on top of base.
4. Add ingredients as desired.
5. Place lid on container.
6. Turn on and increase speed or pulse ingredients to desired consistency.
7. If ingredients stick to the walls or do not fall near the blades, remove the clear plug in center of lid and use tamper to move items down toward the blades.
8. When blending is complete, turn off and allow blades to come to a complete stop before removing container.

## Caution

---

DO NOT use the tamper without the container lid securely on. The lid will keep the tamper from touching the blades. If lid is completely removed, the tamper could make contact with the blades, causing contamination of ingredients, damage to the blades/motor and possible injury.

The blender has a safety which will prevent it from spinning unless the container is properly secured to the base. Removing the container will automatically stop the unit. However, doing this is not recommended due to possible damage to the gears between the base and container.

## Cleaning & Sanitizing

---

***Before using this equipment it must be cleaned and dried thoroughly. Clean all surfaces before use. Failure to clean surfaces before using the unit could cause food contamination.***

- Wash, rinse, sanitize and dry container prior to initial use, and whenever it will not be used again within a period of 1 hour. Follow manufacturer's instructions for detergent and sanitizer concentration.
- Half fill the container with warm water and a non-sudsing detergent.
- Attach the lid and lid plug.
- Turn the machine ON and gradually increase the speed to MAX and run for 60 seconds.
- Turn off, remove container and rinse with clear warm water.
- Fill container with sanitizing solution, cover and run for 60 seconds.
- Remove the lid and lid plug, and wash along with the tamper in warm soapy water. Rinse and dry with a soft cloth.
- The power base can be wiped off with a damp cloth.
- Do not immerse the base of unit completely in water or use a dishwasher to clean.

***Warning: do not allow excess liquid to drip into ventilation openings as this may affect the electrical and mechanical systems.***

### **NOTE:**

***Proper cleaning instructions must be followed; otherwise, operation of the unit may be seriously impaired. Do not wash parts in an automatic dishwasher.***

WINCO® authorized service personnel must perform any other servicing.

## Safety

A WINCO® Approved Service Technician should carry out repairs if necessary. Do not remove any components or service panels on this product.

If the power cord is damaged, it must be replaced by a WINCO® Approved Service Technician in order to avoid a hazard.

## Service and Repair

There are no user-serviceable parts within this appliance. To avoid serious injury or damage, **NEVER** attempt to repair the unit yourself.

To initiate warranty service contact: [support@wincous.com](mailto:support@wincous.com) or call: 973-295-3899.

DO NOT send unit to WINCO® without first contacting our customer service department.

See "Limited Warranty" section on page 10 for details.

## Troubleshooting

If your ACCELMIX™ blender does not operate, please check the following prior to placing a service call.

PROBLEM	POSSIBLE CAUSE	RECOMMENDED SOLUTION
The unit is not turning on	Power supply	Check that the power supply cord is correctly plugged in and outlet is working.
	Breaker has blown	Reset breaker button on the rear base of the unit.
	Container is not sitting on base properly	Make sure container is secured to the base correctly.
	Power switch has not been turned on	Check that the unit is plugged in and turned on.
	Plug/cord or external wiring is damaged	Call WINCO to make service arrangements through their service provider network.
	Internal wiring fault	
The unit is vibrating too much	Unit is not on stable surface	Place the unit on a level surface or on top of a vibration resistant surface such as a rubber mat.
	Lid is not on properly	Adjust the lid so that it fits tightly and is centered on the container.
	Loose hardware	Tighten any loose screws, nuts or bolts.

## Exploded View

MODEL XLB-1000

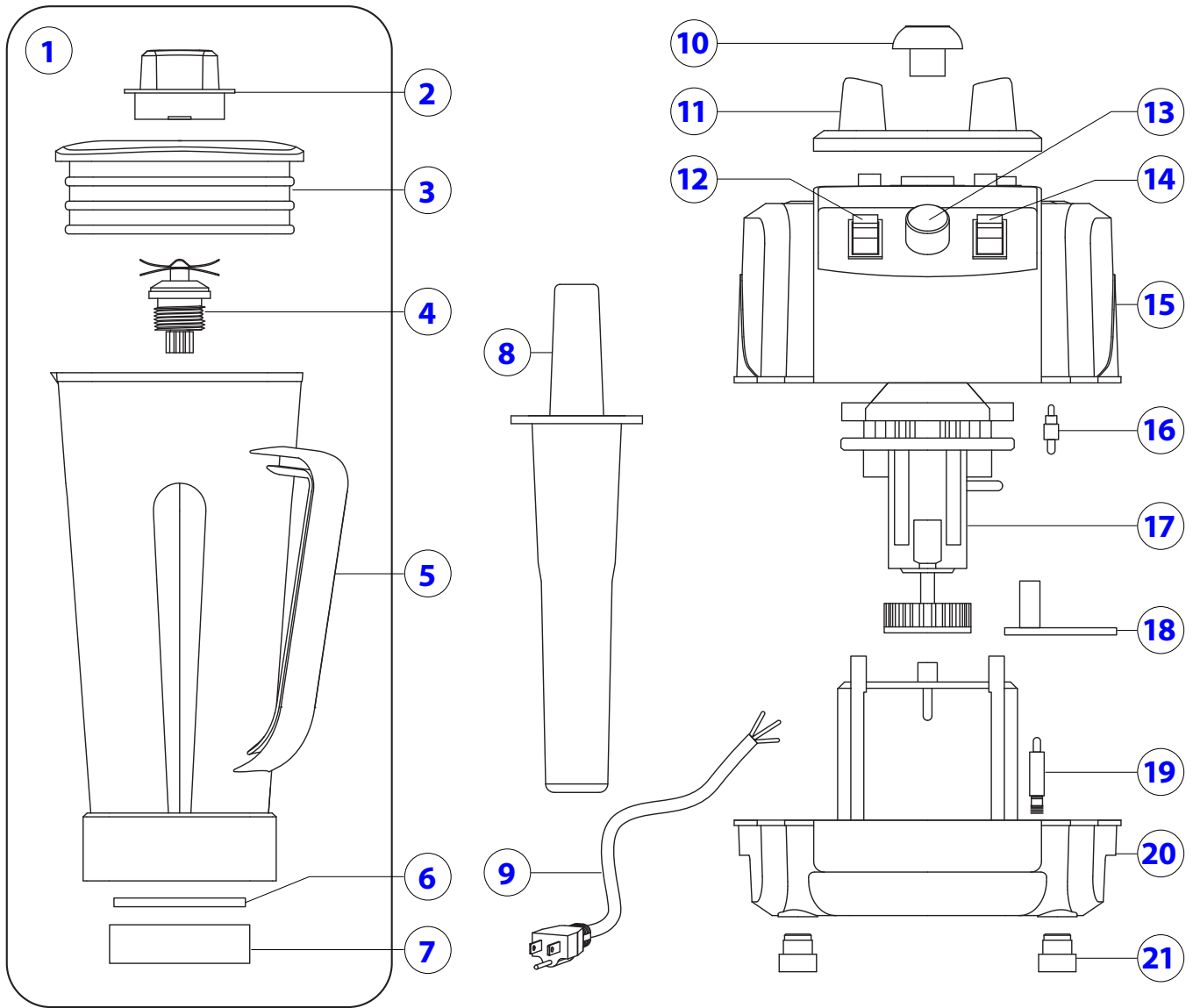

**Spare Parts List**

<b>Model : XLB-1000</b>			
<b>No.</b>	<b>Description</b>	<b>Part #</b>	<b>QTY</b>
1	Container set (2-7)	XLB1000P2	1
2	Refilling cap	XLB1000P4	1
3	Lid	XLB1000P3	1
4	Blade assembly	XLB1000P5	1
5	Pitcher	XLB1000P11	1
6	Gasket	XLB1000P12	1
7	Blade fixing block	XLB1000P13	1
8	Rod Set	XLB1000P1	1
9	Power cord	XLB1000P15	1
10	Mushroom head	XLB1000P10	1
11	Coaster	XLB1000P6	1
12	Power switch	XLB1000P8	1
13	Speed control knob	XLB1000P7	1
14	Pulse Switch	XLB1000P8	1
15	Upper cover	Contact Factory	1
16	Safety Switch	XLB1000P14	1
17	Motor	XLB1000P17	1
18	PCB Board	XLB1000P18	1
19	Over current Micro Switch	XLB1000P16	1
20	Bottom	Contact Factory	1
21	Rubber feet	XLB1000P9	4

## Limited Warranty

---

WINCO® warrants to the original purchaser of new equipment that said equipment, when installed in accordance with our instructions within North America and subjected to normal use, is free from defects in material or workmanship for a period of 1 year. The labor warranty is one year from original installation or 18 months from actual factory shipment date, whichever date occurs first.

**THIS WARRANTY IS IN LIEU OF ALL OTHER WARRANTIES, WHETHER EXPRESSED OR IMPLIED. WINCO EXPRESSLY DISCLAIMS ANY IMPLIED WARRANTY OF MERCHANTABILITY OR EXPRESSED OR IMPLIED WARRANTY OF FITNESS FOR A PARTICULAR PURPOSE.**

**WINCO'S OBLIGATION AND LIABILITY UNDER THIS WARRANTY IS EXPRESSLY LIMITED TO REPAIRING AND REPLACING EQUIPMENT THAT PROVES TO BE DEFECTIVE IN MATERIAL OR WORKMANSHIP WITHIN THE APPLICABLE WARRANTY PERIOD.**

**IN NO EVENT SHALL WINCO BE LIABLE FOR INCIDENTAL OR CONSEQUENTIAL DAMAGES TO BUYER OR ANY THIRD PARTY, INCLUDING, WITHOUT LIMITATION, LOSS OF PROPERTY, PERSONAL INJURY, LOSS OF BUSINESS OR PROFITS OR OTHER ECONOMIC LOSSES, OR STATUTORY OR EXEMPLARY DAMAGES, WHETHER IN NEGLIGENCE, WARRANTY, STRICT LIABILITY, OR OTHERWISE.**

This warranty is given only to the first purchaser from a retail dealer. No warranty is given to subsequent transferees.

Warranty does not cover product failures caused by: failure to maintain, neglect, abuse, damage due to excess water, fire, normal wear, improper set up and use. Periodic maintenance is not covered.

This warranty is not in force until such time as a properly completed and digitally signed Installation/Warranty Registration has been received by WINCO within 30 days from the date of installation.

### **WARRANTY SERVICE**

To initiate warranty service contact: [support@wincous.com](mailto:support@wincous.com)  
or call: 973-295-3899

DO NOT send unit to WINCO® without first contacting our customer service department.

### **REGISTER ONLINE AT:**

<http://support.wincous.com>

Proof of purchase is required to extend warranty more than 1 year from date of shipment from the factory.

## Limited Warranty

---

**THE FOREGOING WARRANTY PROVISIONS ARE A COMPLETE AND EXCLUSIVE STATEMENT BETWEEN THE BUYER AND SELLER. WINCO® NEITHER ASSUMES NOR AUTHORIZES ANY PERSONS TO ASSUME FOR IT ANY OTHER OBLIGATION OR LIABILITY IN CONNECTION WITH SAID EQUIPMENT.**

Examples of items not covered under warranty, but not limited to just these items:

1. Acts of God, fire, water damage, burglary, accident, theft.
2. Freight damage.
3. Improper installation or alteration of equipment.
4. Use of generic or after-market parts.
5. Repairs made by anyone other than a WINCO® designated service provider.
6. Lubrication.
7. Expendable wear parts, adjustable feet, blown fuses, lamps, etc.
8. Cleaning of equipment.
9. Misuse or abuse.

**Please keep this manual in a safe place for future use!**



**ACCELMIX™**

Model: [XLB-1000](#)

[www.wincous.com](http://www.wincous.com)