

WARING[®]

COMMERCIAL

HEAVY-DUTY DEEP FRYERS

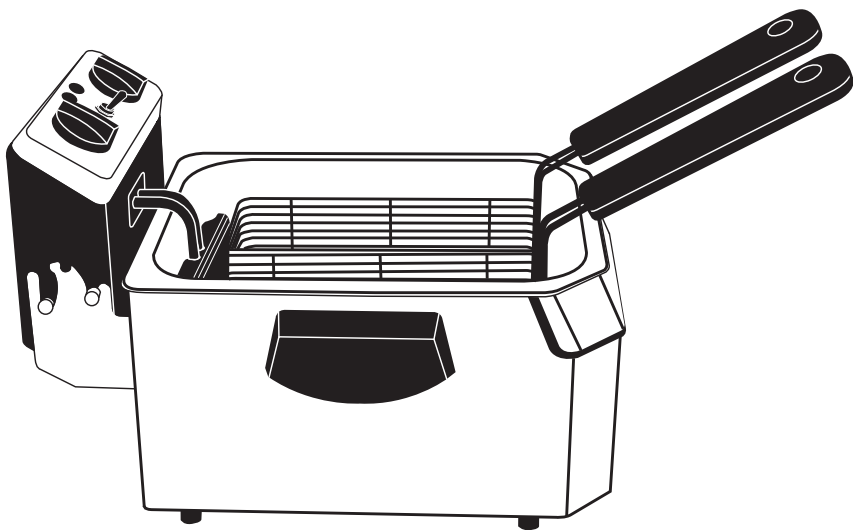

**WDF1000, WDF1000B, WDF1000D, WDF1000BD,
WDF1500B, WDF1500BD, WDF1550, WDF1550D**

For your safety and continued enjoyment of this product,
always read the instruction book carefully before using.

IMPORTANT SAFEGUARDS

When using electrical appliances, basic safety precautions should always be followed, including the following:

1. **READ ALL INSTRUCTIONS.**
2. Do not touch hot surfaces. Use handles and knobs.
3. To protect against electric shock, do not immerse heating element, cord, plug or deep fryer in water or other liquid.
4. This appliance should not be used by, on or near children or individuals with certain disabilities.
5. Never leave appliance unattended when connected to the power outlet.
6. Unplug from outlet when not in use and before cleaning. Allow to cool before putting on or taking off parts, and before cleaning the appliance.
7. Do not operate any appliance with a damaged cord or plug, or after the appliance malfunctions or has been damaged in any manner. Return appliance to the nearest authorized service center for examination, repair or adjustment.
8. The use of attachments not recommended or sold by the manufacturer may result in fire, electric shock or injury.
9. Do not use outdoors.
10. Do not let cord hang over edge of table or counter, or touch hot surfaces.
11. Do not place on or near a hot gas or electric burner, or in a heated oven.
12. Do not operate under cabinets.
13. Extreme caution must be used when moving the deep fryer if it contains hot oil or other liquids.
14. The appliance will automatically shut off if operation exceeds 12 minutes without oil. If this occurs, resetting of the appliance is required.
15. If appliance still does not function after following reset instructions, please contact a Waring® Certified Customer Service Center for assistance.

16. Do not use this appliance for other than intended use.
17. Do not attempt to operate unit while night cover is on. Only use night cover when the deep fryer is off and the oil is cool.
18. The [WDF1000D](#), [WDF1000BD](#), [WDF1500BD](#), and [WDF1550D](#) are supplied with two individual power cords. Each power cord must be plugged into its own separate branch circuit for the rated voltage and amps stated on the rating label.
19. Before moving the [WDF1000D](#), [WDF1000BD](#), [WDF1500BD](#), or [WDF1550D](#), both power cords must be unplugged from power source.

SAVE THESE INSTRUCTIONS FOR COMMERCIAL USE ONLY

IMPORTANT SAFETY TIPS

1. Use basket handle to raise and lower basket. Always raise basket out of hot oil and rest on basket hook, to allow food to drain for 10 to 20 seconds.
2. Wet food should be dried first with paper towels. Remove loose ice from frozen foods. Beware of splattering oil when food is put into the oil.
3. Keep appliance at least 4 inches away from walls or other objects during operation. Do not place any objects on top of appliance while it is operating.
4. Be sure oil container is filled to at least the minimum oil level. Do not fill above the maximum. Do not operate appliance without oil or with an insufficient amount of oil. Fill container only when it is cool. Never pour oil into heated oil container.
5. Do not operate this appliance if the oil container is not completely dry.
6. Keep this fryer out of reach of children while in use and away from edges of countertops where it could be pulled off or pushed over by children.

CAUTION: To prevent damage to countertop or tabletop finish, use a nonflammable, heat-resistant coaster or placemat between the appliance and the countertop or tabletop surface. Never place on carpet, furniture, or other combustible materials.

PARTS

- | | |
|--|-----------------------------------|
| 1. Stainless steel body | 7. Temperature control |
| 2. Baskets (Also includes large single basket) | 8. On/Off toggle switch |
| 3. Basket hook (not shown) | 9. Power On indicator light |
| 4. Oil container with pouring spout | 10. Oil Ready indicator light |
| 5. Basket handle | 11. Heating element with diffuser |
| 6. Mechanical timer | 12. Control panel |
| | 13. Reset button |
| | 14. Night cover |

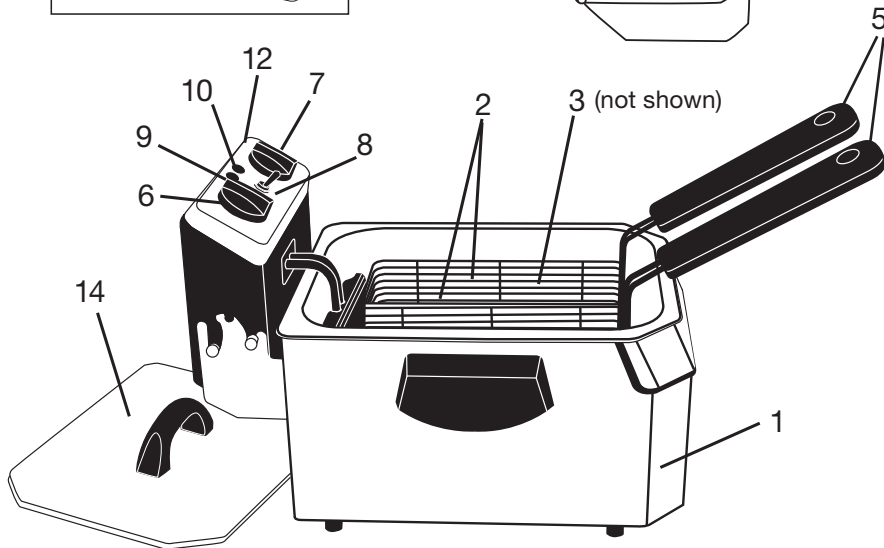
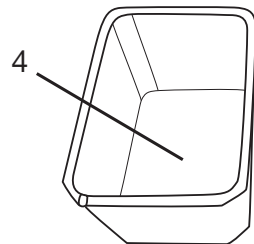
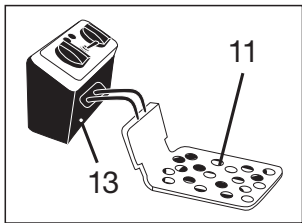

3

GROUNDING INSTRUCTIONS

For your protection, the Waring Commercial deep fryers are supplied with a molded 3-prong grounding-type plug and should be used in combination with a properly connected grounding-type outlet. Use of any other voltage or altering of the plug or cord may damage the unit, will void warranty and may cause injury.

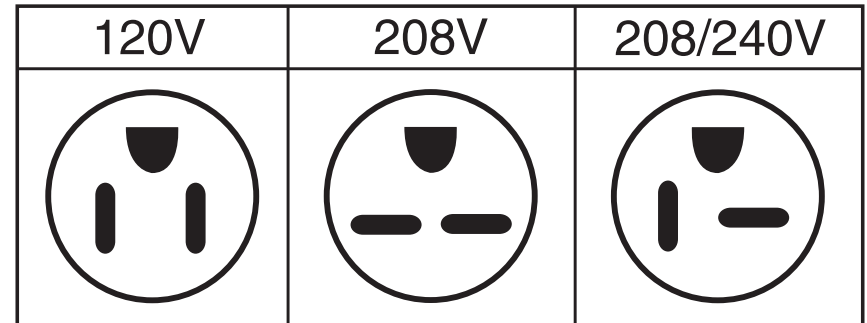

NEMA 5-15P
Models: WDF1000,
WDF1000D

NEMA 6-15P
Models: WDF1000B,
WDF1000BD

NEMA 6-20P
Models: WDF1500B,
WDF1500BD,
WDF1550,
WDF1550D

3 ft. Cord with Plug Configuration

10-LB FRYERS

MODEL	WDF1000	WDF1000D	WDF1000B	WDF1000BD
SINGLE / DOUBLE	SINGLE	DOUBLE	SINGLE	DOUBLE
VOLTS	120	120	208	208
WATTS (EACH HEATER)	1800	1800 (2)	2700	2700 (2)
PLUG	5-15	5-15	6-15	6-15
OIL CAPACITY PER CONTAINER (GALLONS)	1.32	1.32 (2)	1.32	1.32 (2)
DIMENSIONS (MM)	321 (W) X 425 (D) X 298 (H)	606 (W) X 425 (D) X 298 (H)	321 (W) X 425 (D) X 298 (H)	606 (W) X 425 (D) X 298 (H)

4

15-LB FRYERS

MODEL	WDF1500B	WDF1500BD	WDF1550	WDF1550D
SINGLE / DOUBLE	SINGLE	DOUBLE	SINGLE	DOUBLE
VOLTS	208	208	240	240
WATTS (EACH HEATER)	3300	3300 (2)	3840	3840 (2)
PLUG	6-20	6-20	6-20	6-20
OIL CAPACITY PER CONTAINER (GALLONS)	1.89	1.89 (2)	1.89	1.89 (2)
DIMENSIONS (MM)	362 (W) X 464 (D) X 311 (H)	678 (W) X 464 (D) X 311 (H)	362 (W) X 464 (D) X 311 (H)	678 (W) X 464 (D) X 311 (H)

ASSEMBLY OF DOUBLE FRYERS

A double fryer is constructed with two single fryer housings and a mounting bracket between them. To assemble, follow the following instructions:

1. Unpack all components.
2. Place both housings side-by-side with the bracket in the middle. The open end of the bracket should be facing toward the ground once assembled. There is no front or back to the bracket. Do not attempt to assemble with oil containers or heating elements in the housings.
3. The bracket in the middle has 8 pressed-in threaded standoffs (holes for mounting screws), 4 on each side. There are 8 screws and 8 spring washers supplied. Line up the holes of the standoffs with the 4 holes on the inside of one deep fryer housing. Place the supplied screws through the washers and then into each standoff hole with the top of the screw facing the inside of the housing. Tighten with screwdriver as tightly as possible.
4. Repeat step 3 with the other housing and additional 4 screws, and washers, to the other side of the mounting bracket.

SHORT CORD INSTRUCTIONS

CAUTION: A short power supply cord is provided to reduce the risk of personal injury resulting from becoming entangled in or tripping over a long cord.

EXTENSION CORD USE

An extension cord or longer detachable cord is not recommended for use with deep-fat fryers.

ELECTRIC POWER

If the electrical circuit is overloaded with other appliances, your appliance may not operate. It should be operated on an electrical circuit that is free from the other appliances. If you are not sure of the reason for overloading or cannot find a separate circuit, contact a qualified electrician.

ASSEMBLY OF BASKETS

The handle of each basket easily mounts to the steel basket with one wingscrew, washer, and nut. Find the included screw in its packaging. Line up the hole on the handle with the hole on the basket (as shown). With the nut on the inside of the basket, place the wingscrew through the washer, then the basket hole, then handle hole, then nut, and tighten with hands.

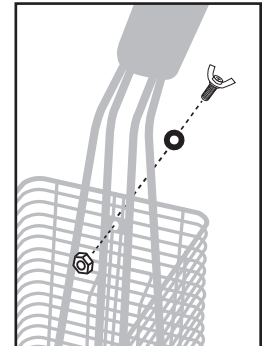

HOW TO USE YOUR WARING® COMMERCIAL DEEP FRYER

1. **This appliance is designed for commercial use only.**
2. Before the Waring® Commercial Deep Fryer is used for the first time, remove all packaging materials and follow cleaning instructions in this book.
3. Remove baskets from oil container.
4. Pour approximately 5 liters (1.32 gallons) for 10-lb containers, or 7.5 liters (1.89 gallons) for 15-lb containers of good quality vegetable, corn, canola, soybean, or peanut oil into reservoir until it reaches between the Min and Max marks inside container.

DO NOT OVER- OR UNDER-FILL.

VERY IMPORTANT: If solid shortening is used, be certain the shortening is pre-melted.

5. Plug cord into outlet.
6. Turn on the Waring® Commercial Deep Fryer by flipping the toggle switch up. The On light will glow to show the unit is on.
7. Set the temperature control knob to the desired temperature. The oil Ready light will turn green once the oil has reached the desired temperature.
8. Place basket(s) onto hook in oil container. Put food into basket(s). Do not exceed the MAX fill line on the basket(s). Lower basket(s) into oil.
9. Set timer (up to 30 minutes) to cooking time specified, depending on what you are cooking.
10. Timer will ring when set time has elapsed. Raise the basket(s) to see if the food has reached the required golden color. If the food is done, carefully lift and hang basket(s) on hooks inside the oil container. Allow oil to drain 10 to 20 seconds. Remove basket(s), and place cooked food onto absorbent paper towels.
NOTE: To preserve oil quality, do not add salt or spices to the food until after it has been removed from the fryer.
11. **WARNING: The timer does not switch appliance off.**
12. When cooking is finished, shut down fryer by switching toggle off. Unplug the cord from the wall outlet.
13. The night cover may be used to keep dust and foreign objects out of the oil when the unit is not in use.
IMPORTANT: Do not attempt to operate unit with the cover on.

CLEANING INSTRUCTIONS

1. Always unplug appliance, and let the oil cool down to room temperature before cleaning.
2. Lift out basket(s).
3. Tilt heating element up from back side of fryer. This will drain oil without causing a mess. Once drained, remove from fryer.
4. The control panel should never be immersed in water or other liquids. Clean the outer surface of the heating element with a damp cloth containing mild soap solution or plain water.
5. Carefully tilt oil container, using spout on the corner to pour oil into suitable container.
6. The frying baskets should be hand washed before first use and should be seasoned in oil before going into the dishwasher for the first time. Oil container is dishwasher-safe. Dry parts thoroughly after cleaning.
7. The stainless steel body is submersible and should be washed by hand with warm soapy water.
8. Ensure that the oil container is completely dry after washing and before use.
9. After cleaning, reassemble oil container, heating element and baskets onto deep fryer. The heating element must be seated properly or appliance will not operate properly.
10. Warning: When cleaning, use care – under-edge of deep fryer is sharp.
11. Tip: For ease in cleaning, wipe control panel with damp microfiber cloth. Microfiber cloths are available in most kitchenware stores.

SAFETY FEATURES

The Waring® Commercial Deep Fryer is equipped with the following features to ensure safety:

- **Thermostat Overload Protection** – Your Waring®

Commercial Deep Fryer is equipped with thermostat overload protection. If the unit heats up beyond the recommended temperature level, the deep fryer will automatically turn off. To reset, unplug the unit from the wall outlet and allow it to cool down. Remove the control panel and heating element from the unit.

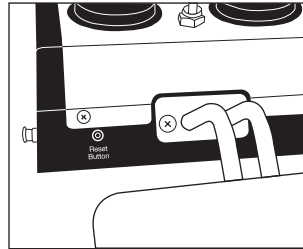

CAUTION: Heating element is extremely hot. Allow it to cool thoroughly before removing it. You will find a reset button on the front of the control panel below controls. Using a toothpick or another long, thin object, push the reset button and properly place the control panel back into position.

NOTE: The unit will not work if the control panel is not properly mounted. Plug the unit back in, turn on and continue use. If the unit still does not operate, repeat the steps above or call a Waring® Certified Customer Service Center for assistance.

HINTS

- When cooking foods dipped in fresh batter, first lower baskets. Using tongs, add food directly to oil. Use baskets to lift out food when finished cooking.
- Do not exceed the MAX fill line in the baskets. This helps maintain temperature of oil for better cooking results.
- Sort or cut food into uniform pieces. All the food will then be cooked in the same amount of time. To reduce splattering, remove excess moisture or ice from food.
- Leave oil in oil container for a limited time. When oil has cooled to room temperature, pour into a suitable container with lid and refrigerate.

- For best results, change oil in deep fryer after a maximum of ten uses.
- It is important to follow the temperature recommendation for every recipe. If the temperature is too low, the fried food absorbs oil. If the temperature is too high, a crust quickly forms on the outside while the inside remains uncooked.
- For best results, drop freshly sliced food into baskets one piece at a time.

FRYING FROZEN FOODS

- Due to their extremely low temperature, frozen foods inevitably lower the temperature of the oil. For best results, do not overload the baskets with frozen foods.
- Follow the instructions on the frozen food package for cooking time and temperature.
- Frozen foods are frequently covered with a coating of ice crystals, which should be removed before frying. Lower the baskets very slowly into the oil in order to ensure that oil does not boil over.

FILTERING AND CHANGING THE OIL

- Make sure the Waring® Commercial Deep Fryer is unplugged and the oil has cooled before cleaning or storing.
- The oil does not need to be changed after each use. In general, the oil will be tainted rather quickly when frying food containing a lot of protein (such as poultry, meat or fish). When oil is mainly used to fry potatoes and it is filtered after each use, it can be used 8 to 10 times. However, do not use the oil for longer than 6 months.
- **WARNING:** Always unplug from wall socket before cleaning. Allow the Waring® Commercial Deep Fryer and the oil to cool completely (approximately 2 hours) before cleaning. Never immerse the control panel, cord or plug in water or any other liquid.

©2009 Conair Corporation
Waring Commercial
314 Ella T. Grasso Avenue
Torrington, CT 06790
www.waringproducts.com
Printed in China

WDF1000SERIES IB
09WC12993

IB-9155A