

Unit Information

120 volt – 60Hz – 13 Amps

Limited 2 Year Motor Warranty
 Limited 2 Year Parts and Labor Warranty



035236

Control Panel Overlay

WARING COMMERCIAL® Torq 2.0 Blender

with Electronic Keypad, Timer
 & 64 oz. Stainless Steel
 Container
TBB160S6

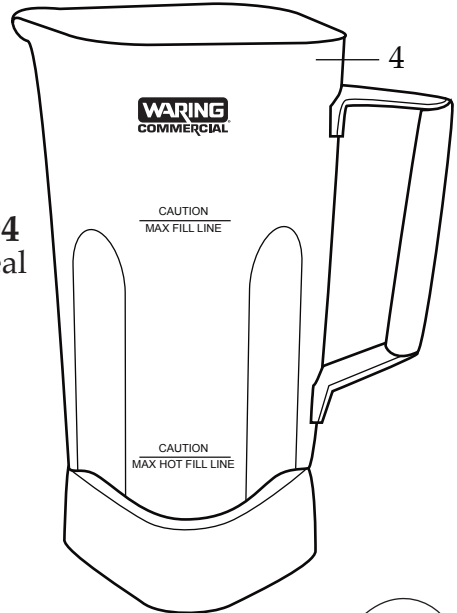
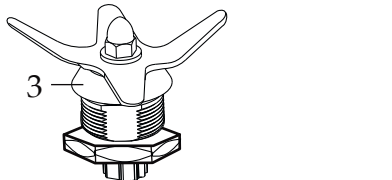
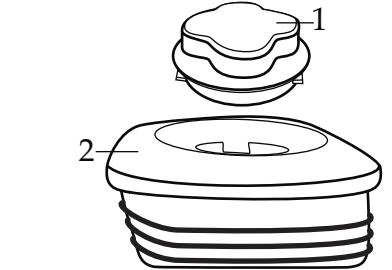
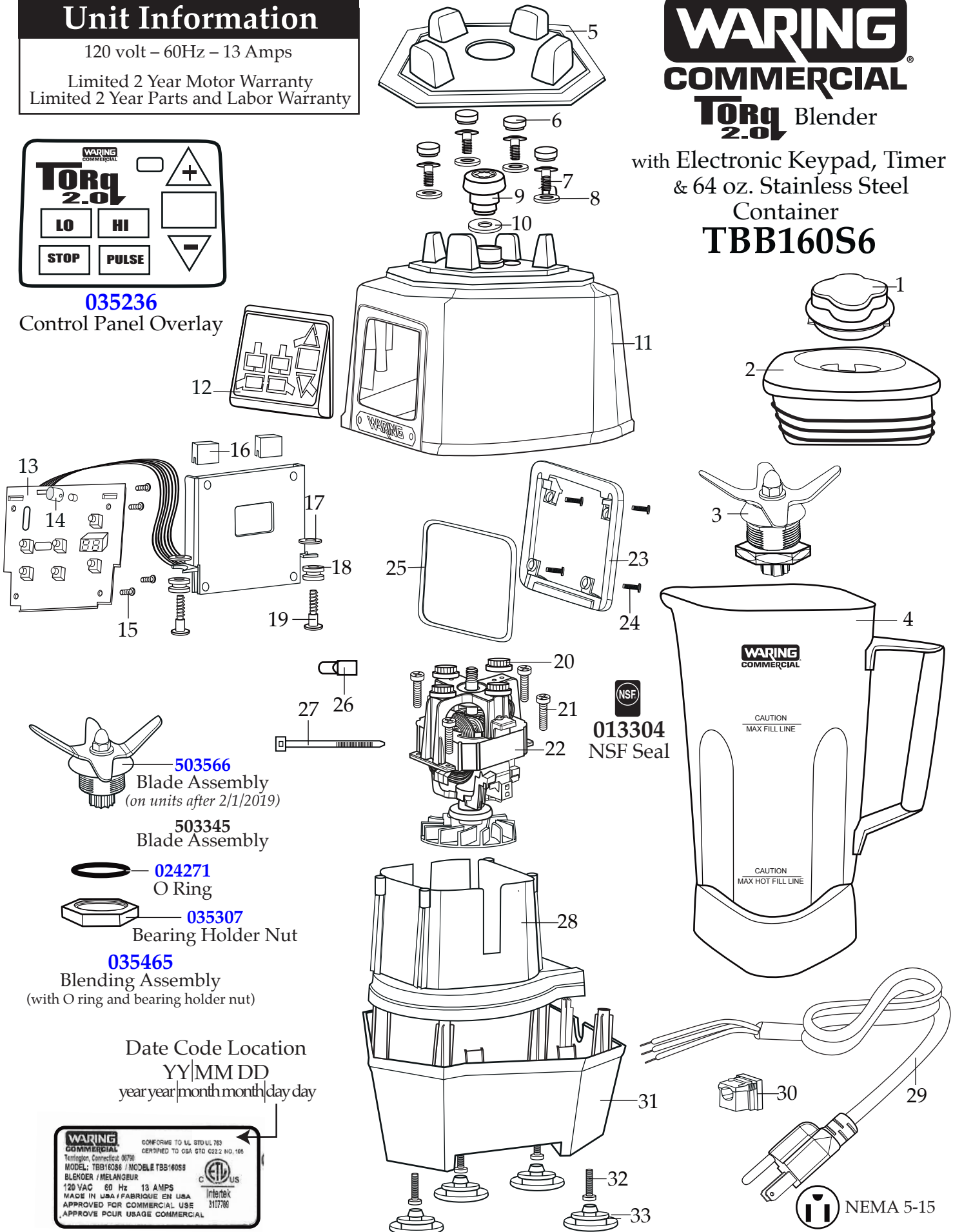

- 503566**
Blade Assembly
(on units after 2/1/2019)
- 503345**
Blade Assembly
- 024271**
O Ring
- 035307**
Bearing Holder Nut
- 035465**
Blending Assembly
(with O ring and bearing holder nut)

Date Code Location
 YY|MM DD
 year year | month month | day day

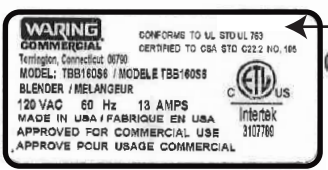

Illustration#	Part#	Description
1	026425-E	Eastman Jar Lid Cover
2	026424-V	Vinyl Jar Lid
3	032483	Blending Assembly Kit
4	503346	64 oz. Stainless Steel C
5	035885	Jar Pad
6	035085	Hole Plug (4 required)
7	034275	Sems (4 required)
8	034273	B Gasket (4 required)
9	037034 035251	Drive Coupling Machined 2 Gen. <i>(on units after 11/15/2019)</i> Drive Coupling
10	037033	Coupling Washer <i>(on units after 11/15/2019)</i>
11	503609 503460-160	Top Housing with Badge <i>(on units after 9/28/2022)</i> Top Housing Assembly
12	035234	Control Housing Front Bezel <i>(on units after 9/28/2022)</i>
13	037012 035162	Control Panel <i>(on units after 1/17/2022)</i> Control Panel Assembly
14	035253	LED Lens
15	035090	Screw (4 required)
16	034900	PCB Cushion (2 required)
17	013604	Washer (2 required)
18	034904	Rubber Grommet (2 required)
19	034902	Sems (2 required)
20	034272	A Gasket (4 required)
21	034274	Screw (4 required)
22	035815 034276	Chiphua Motor with Sensor <i>(on units after 6/4/2021)</i> ECM Motor /KB500
23	035237	Control Housing Back Bezel <i>(on units after 9/28/2022)</i>
24	035090	Screw (4 required)
25	038576	Top Housing Control Seal <i>(on units after 9/28/2022)</i>
26	012409 019123	Small Crimp Connectors (2 required) Large Crimp Connector (2 required)
27	013731	Cable Ties (6 required)
28	503483	Motor Housing with Dampeners

Illustration#	Part#	Description
29	035124	Cordset
30	033619	Strain Relief
31	035079 503480	Bottom Housing Bottom Housing with Feet Assembly
32	034274	Screw (4 required)
33	035088	Foot (4 required)

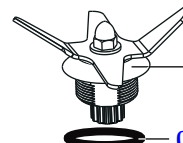

503566
Blade Assembly
(on units after 2/1/2019)

503345
Blade Assembly

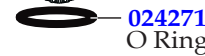

024271
O Ring



026798
Stainless Steel Washer

Part No Longer Used

(last used 10/11/2019)



035237

Control Housing Back Bezel

026648
64 oz Stainless Steel
Container ONLY

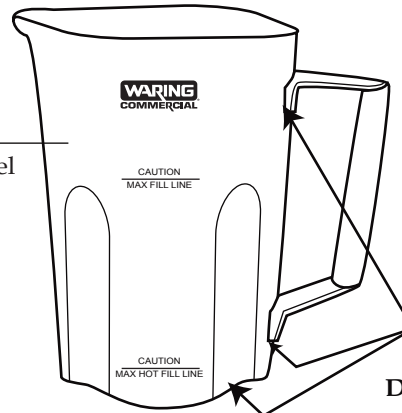

026649
Stainless Steel
Container Support

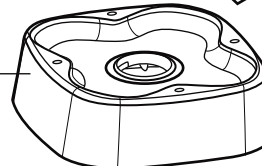

Notes:

Sealant applied all round these indicated areas.
Dow Corning Sealant RTV 733
Torque 100-125 in/lbs.
Lubricant applied to O Ring
Dow Corning 200 (R) Fluid

026797
Bearing Holder Gasket

026796
Stainless Steel Washer

026795
Hex Nut

Wiring Diagram

