



Operator's Manual

Medium Power Countertop Induction Ranges with Temperature Control Probe

SAFETY PRECAUTIONS

To ensure safe operation, read the following statements and understand their meaning. This manual contains safety precautions which are explained below. Please read carefully.

⚠ WARNING

Warning is used to indicate the presence of a hazard that will or can cause severe personal injury or death.

⚠ CAUTION

Caution is used to indicate the presence of a hazard that will or can cause minor or major personal injury if the caution is ignored.

NOTICE: Notice is used to note information that is important but not hazard-related.

To reduce risk of injury or damage to the equipment:

- Unplug this equipment from the wall outlet when not in use.
- Use this equipment only in a flat, level position.
- To protect against electrical shock, do not immerse the cord or plug in water. Keep the cord away from heated surface. Do not let the cord hang over the edge of table or counter.
- As a precaution, persons using a pacemaker should stand back 12" (30 cm) from an operating unit. Studies have shown that the induction element will not disrupt a pacemaker.
- Keep all credit cards, driver licenses, and other items with a magnetic strip away from an operating unit. The unit's magnetic field will damage the information on these strips.
- The heating surface is made of a strong, non-porous material. However, should it crack or break, stop using and immediately unplug the unit. Cleaning solutions and spills could penetrate the broken cook-top and create a risk of electrical shock.
- Do not operate this equipment with a damaged cord or plug or if it is not functioning properly.
- Do not operate unattended. Closely supervise units operating in public areas and/or around children.
- Do not place any objects inside the air intake or exhaust panels.
- Do not modify the equipment or attach any accessory other than the included temperature control probe and USB flash drive.

FUNCTION AND PURPOSE

This equipment is intended to heat food in commercial food service operations only. It is not intended for household, industrial, or laboratory use. It is intended to be used with induction-ready cookware. Performance is optimized with Vollrath induction-ready cookware. Other cookware may have different properties which may alter performance. The Temperature Control Probe is intended to provide advanced temperature control. It is not intended to be used as a thermometer for measuring the temperature of food. The temperature control probe port is intended for use only with the Vollrath supplied probe. It is not a headphone jack. The USB port is intended for use only with the supplied USB flash drive.



Item No.	Watts	Plug
MPI4-1800S	1800	NEMA 5-15P
MPI4-1440S	1440	

TABLE OF CONTENTS

Environment Requirements	page 2
Clearance Requirements	page 2
Features and Controls	page 3
Operation	page 4
Edit the Default Programs	page 7
Cleaning	page 8
Troubleshooting	page 9
Fuse Instructions	page 11

COOKWARE REQUIREMENTS

Compatible

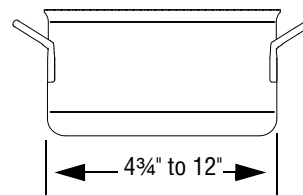

- Flat base 4 $\frac{3}{4}$ " to 12" (12.1 to 30.5 cm) in diameter
- Ferrous stainless steel, iron, cast iron

Incompatible

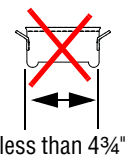

- Base is not flat
- Base is less than 4 $\frac{3}{4}$ " (12.1 cm) in diameter
- Pottery, glass, aluminum, bronze or copper cookware

Note: Cookware with inferior construction or material may not perform well. Cookware with a larger base diameter can be used, however only the area of the cookware above the induction coil will heat. The more cookware extends past the coil, the more the overall performance will be reduced.

ENVIRONMENT REQUIREMENTS

NOTICE: Indoor use only.

NOTICE: Do not place the equipment on or near heat-producing equipment.



NOTICE: This equipment requires a dedicated electrical circuit.



Maximum Ambient Temperature as measured at the air intake. See  below): 104°F (40°C)

CLEARANCE REQUIREMENTS

NOTICE: This equipment is not designed to be enclosed or built into any area. Sufficient airflow must be allowed around the equipment. Blocking the airflow could reduce performance.

 2" (5.1 cm) minimum clearance  Air intake  Air exhaust

Single Range

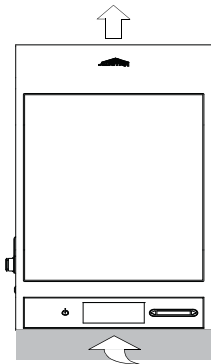

Two Ranges

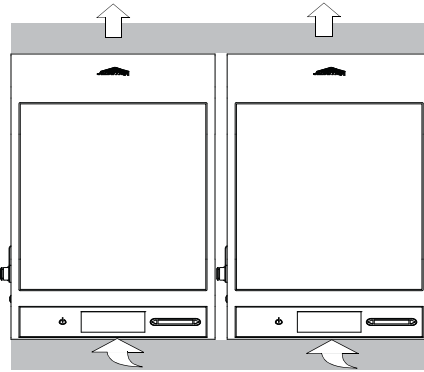
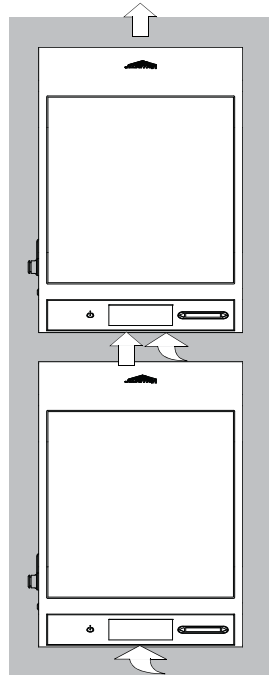

Three or More Ranges Placed Side to Side

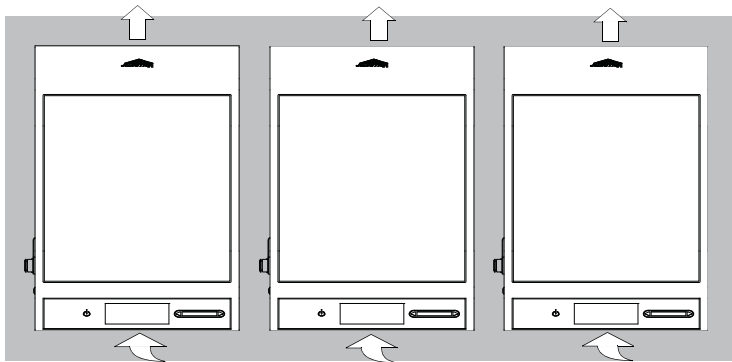

Four Ranges

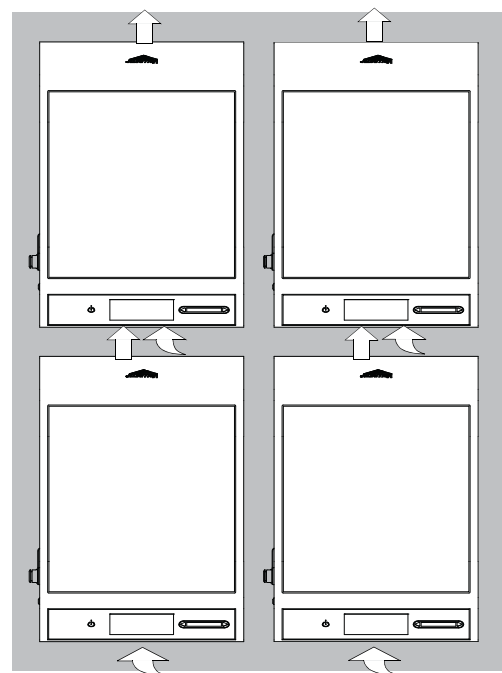

FEATURES AND CONTROLS

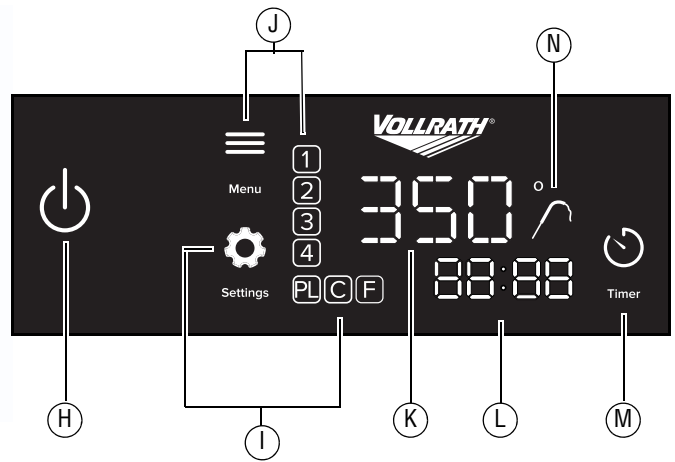

A Temperature Probe Clip

B Temperature Control Probe

- Monitors food and cooks at set temperature.
- Use for most precise temperature control.
- Use for sauces, stocks, deep frying.
- Not for use as a thermometer.

C USB Port

D USB Flash Drive

E Temperature Control Probe Port

F Control Panel

G Slider. Sets the power level, temperature, or time.

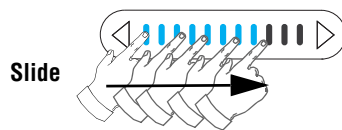
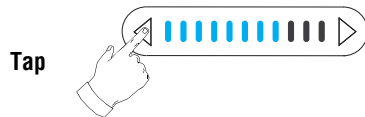

H Power On/Off

I Settings

PL 1-100% of power

- Responsive, gas flame-like control.
- Use for fast, powerful heating.
- Use for boiling, sautéing, searing, omelets.

C Temperature in °C

- Single degree increments in °F or °C.
- Steady, controlled heating.

F Temperature in °F

- Use for more precise pan control.
- Use for sauces, poaching.

J Programs. Four customizable programs. See “Edit the Default Programs” on page 7.

K Power Level and Temperature Display

L Timer Display

M Timer On/Off

N Temperature Control Probe Indicator

OPERATION



WARNING

Electrical Shock Hazard

Keep water and other liquids from entering the inside of the equipment. Liquid inside the equipment could cause an electrical shock.



CAUTION

Burn Hazard

Do not touch hot food, liquid or heating surfaces while equipment is heating or operating.

NOTICE: This equipment requires a dedicated electrical circuit.

NOTICE: Using a voltage other than the nameplate rated voltage modifying the power cord or electrical components may damage unit and will void the warranty.

NOTICE: Do not use extension cords, power strips or surge protectors with this equipment.

NOTICE: Do not preheat empty cookware or leave an empty pan on an operating unit. Because of the speed and efficiency of the induction range, cookware can very quickly overheat and be damaged.

NOTICE: Do not drop cooking utensils or other objects onto the cooking surface or control panel. The surfaces could break. The warranty does not cover broken cooktop or control panel glass.

NOTICE: Do not use heat-sealed cans or containers. They may explode.

NOTICE: When the temperature control probe or the USB flash drive are not in use, the covers must be installed over the ports. Operating this equipment without the covers could allow food debris or moisture to enter the ports which could damage the equipment. This type of damage is not covered by the warranty.

Turn on the Induction Range

1. Place the induction range on a flat stable surface.
2. Plug the power cord into a grounded electrical outlets that matches the voltage on the rating label.
3. Place a pan containing food or liquid onto the cooking surface.

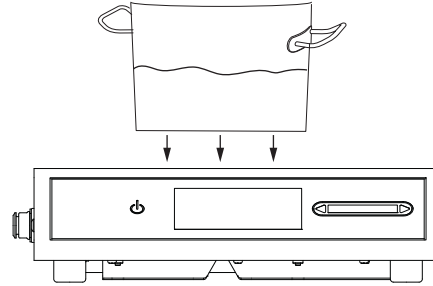







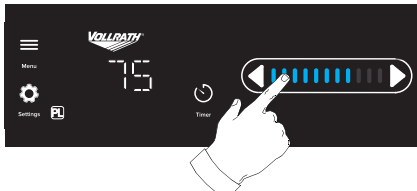

4. Touch 

OPERATION (CONTINUED)

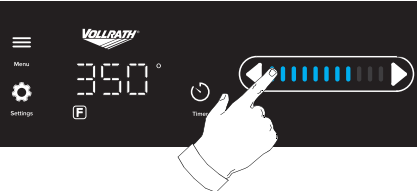
Select a cooking method

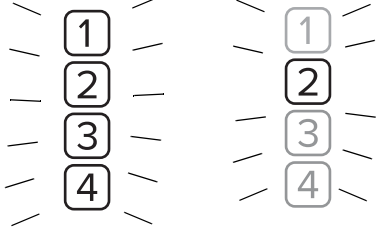
Choose between power level, pan temperature, or select one of the cooking programs.

Power Level <ul style="list-style-type: none"> Responsive, gas flame-like control. Use for fast, powerful heating. Use for boiling, sautéing, searing, omelets. 	Temperature <ul style="list-style-type: none"> Single degree increments in °F or °C. Steady, controlled heating. Use for more precise pan temperature. Use for sauces, poaching. 	Program <ul style="list-style-type: none"> Select a default program or see “Edit the Default Programs” on page 7 for how to create a custom program.
<p>1. Touch  repeatedly until PL is selected.</p> <p></p> <p>2. Tap an arrow or use the slider to select a power level.</p> 	<p>1. Touch  repeatedly until C or F is selected.</p> <p></p> <p>2. Tap an arrow or use the slider to select a temperature.</p> <p>Tip: When heating delicate foods, start with a lower temperature and gradually increase temperature.</p> 	<p>1. Touch .</p> <p>2. The program numbers will flash.</p> <p>3. Touch  repeatedly until the desired program is selected (not flashing)</p> <p></p> <p>1 Chocolate. Use the probe. Heat to 110° F. Hold at 90° F. No timer.</p> <p>2 Fajita Heater. Power Level 100 for 2 minutes.</p> <p>3 Simmer. Use the probe. Heat to 190° F. No timer.</p> <p>4 Rethermize Chilled Food. Use the probe. Heat to 165° F. Hold for 2 minutes. Hold at 155° F. No timer.</p> <p>4. After three seconds the program will start.</p> <p>The  will flash to indicate the program is running.</p> <p>To Cancel a Program</p> <p>Touch  repeatedly until all program numbers are unselected.</p>

OPERATION (CONTINUED)

Set the Timer (Optional)

1. Touch .
2. The time will flash.

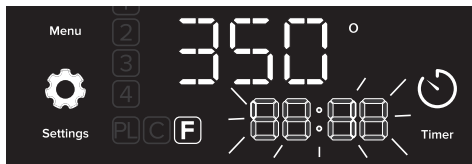

3. Touch  to set the time in 30 second increments.

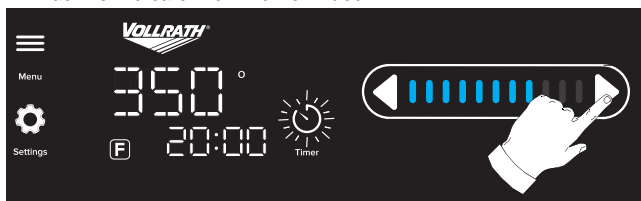

After three seconds, the timer will begin to count down and  will flash to indicate the timer is in use.

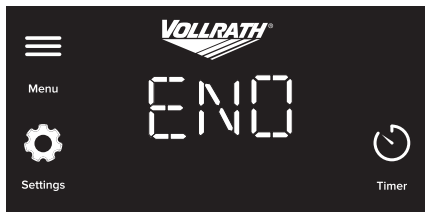

4. When the timer reaches zero, a buzzer will sound and the display will show END.



Change the Duration of Time

1. Touch .
2. Then touch  or .

Cancel the timer

- Touch  x 2.

Use the Temperature Control Probe (Optional)

The temperature control probe provides advanced temperature control. The probe monitors the temperature of the food and then automatically adjusts the output of the range as needed to heat the food to the selected temperature. For best performance and food quality, stir the food often when using the temperature control probe.

NOTE: The Temperature Control Probe is intended to provide a more consistent and accurate cooking temperature. It is not intended to be used as a thermometer for measuring the temperature of food.

Attach Probe and Insert into the Food

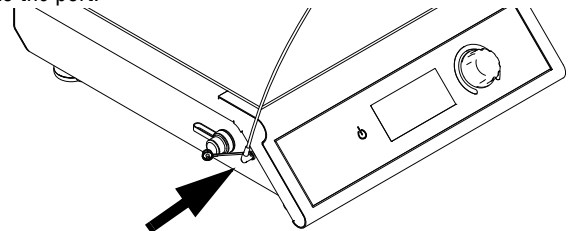

1. Use a soft clean cloth to wipe the tip of the probe. This is important to keep the port clean and working properly.
2. Remove the cover from the temperature control port. Plug the probe into the port.

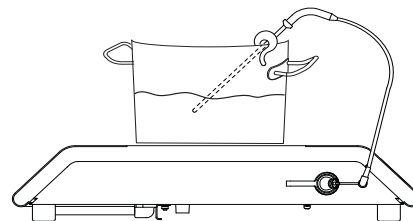

3. Place the probe into the center of the food. Use the included clip to secure the probe to the pan and suspend it in the center of the food. Do not allow the probe to rest on the bottom of the cookware. For accurate temperature control, the probe must be positioned into the center of the food, and not touch the bottom of the pan.



Set the Temperature

1. Touch  repeatedly until **C** or **F** is selected.
2. Touch  or  to select a temperature.

Heat the Food

1. The probe icon will flash as the food heats to the set temperature. The display shows the set temperature.



Set temperature

Food is heating to the set temperature.

2. The probe icon will change to a steady state when the probe detects the food has reached the set temperature.



Set temperature

Food has reached the set temperature.

EDIT THE DEFAULT PROGRAMS

The factory-set programs can be edited. Use a computer to access the program editor on the USB flash drive. Then load the new programs into the induction range. One USB flash drive can be used to program multiple induction ranges.

Load the Program Editor

1. Remove the USB flash drive from the induction range. Insert it into the USB port on your computer.

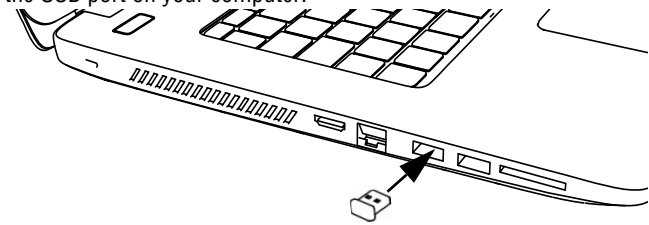

2. Open the Programs folder.

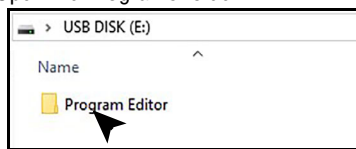

3. Double click the Programs Editor file.

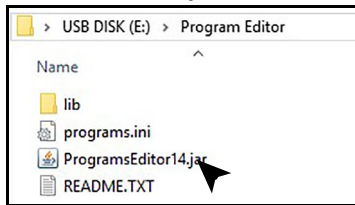

If the Program Editor does not open or if you are asked to choose a program, you may need to install or update the Java program on your computer. Java is free and can be downloaded from www.java.com.

Edit Programs

1. Enter data for up to four programs. Each program can have up to three stages.

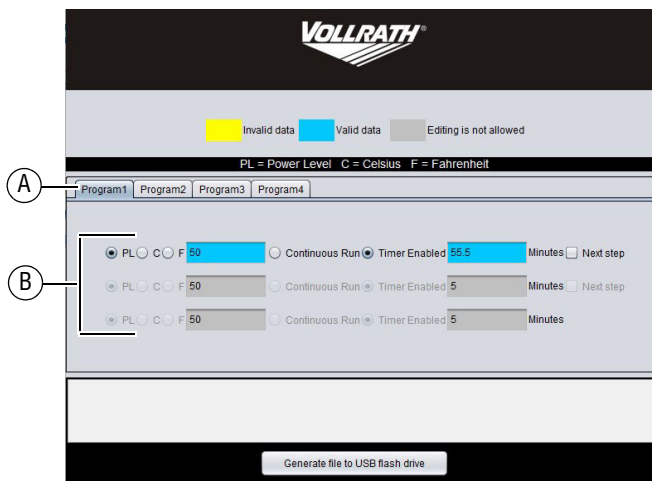

A Programs

B Stages

2. For each stage in the program:

Step 1	Step 2	Optional
Select One	Select One	Enter Time
<input checked="" type="radio"/> PL <input type="radio"/> C <input type="radio"/> F	Power level or temp (°C or °F) 50	Minutes* 5.5 Skip
	<input checked="" type="radio"/> Timer Enabled <input type="radio"/> Continuous Run	<input type="checkbox"/> Next step

*Time can be entered in full and half minutes. To enter a half minute, type .5. For example for five and one half minutes, type 5.5.

3. To edit another program, click the program tab.

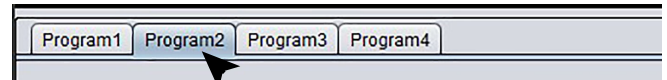

4. Enter data for each program you wish to create.

5. To save the programs, click the Generate File button.

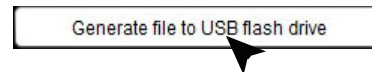

6. When you see the message at the bottom of the program editor window, remove and then re-insert the flash drive.

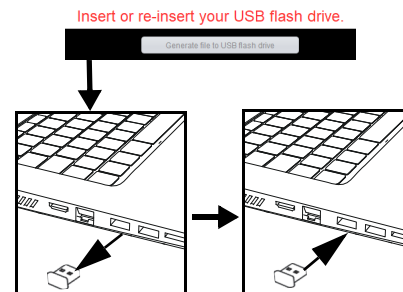

7. The programs are saved to the USB when you see this message

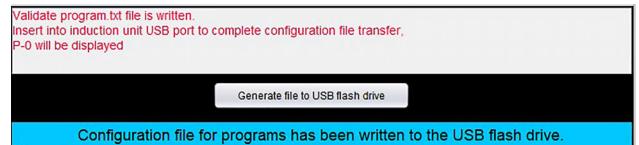

and the programs.txt appears on the file list.

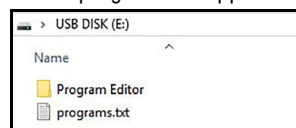

8. The edited programs are now ready to be transferred to the induction range.

EDIT THE DEFAULT PROGRAMS (CONTINUED)

Transfer Programs to the Induction Range

1. Plug in the induction range. Do NOT turn on the range.



2. Only the Vollrath logo on the control panel should be illuminated.

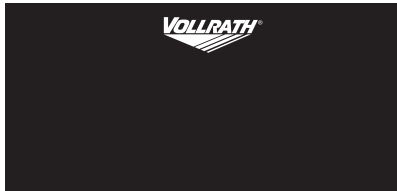

3. Insert the USB flash drive into the induction range. The USB flash drive can be left in the range for storage. Close the USB port cover.

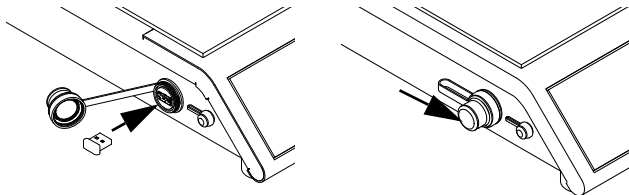

4. When the programs have transferred, the display will show:

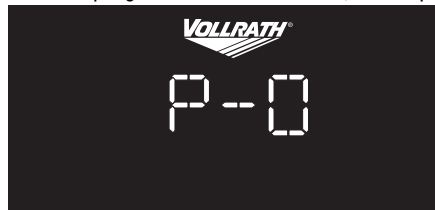

5. Press

6. The new programs are now available for use.

CLEANING

To maintain the appearance and increase the service life, clean your induction range daily.

	WARNING Electrical Shock Hazard Do not spray water or cleaning products. Liquid could contact the electrical components and cause a short circuit or an electrical shock.
--	---

	CAUTION Burn Hazard Heating surface remains hot after equipment is turned off. Hot surfaces and food can burn skin. Allow the hot surfaces to cool before handling.
--	---

NOTICE: Do not use abrasive materials, scratching cleansers or scouring pads to clean the equipment. These can damage the finish.

1. Touch to turn off the range. The display may show HOT until the cooking surface cools.



2. Unplug the cord from the wall outlet.
3. Allow the equipment to cool.
4. Wipe the exterior with a clean damp cloth.
5. Thoroughly wipe off any soap residue.

NOTICE: Soap residue could corrode the surface of the unit.

Clean the USB and Temperature Control Probe Ports (As needed)

The USB and temperature control probe port covers should always be in place when not in use to prevent food debris from entering the ports. However, if food debris does enter the ports, they can be cleaned.

1. Turn off and unplug the induction range.
2. Use a cotton swab dipped into isopropyl alcohol to gently remove the debris.
3. Allow the port(s) to air dry before placing the cap over the port(s).

TROUBLESHOOTING

Problem	Might be Caused By	Course of Action
The display is flashing.	There is not a pan on the range or the pan is not induction-ready.	Place a pan onto the range. Verify the pan is induction ready. See the Cookware Requirements section in this manual.
Message on the Display		
F-01	The range may have overheated because it is too close to heat producing equipment.	Relocate the equipment away from heat producing equipment. Contact Vollrath Technical Services if the problem persists.
F-02	The cookware may have been too hot when it was placed onto the range.	Remove the cookware. Allow it cool slightly before placing it on the cooking surface. Contact Vollrath Technical Services if the problem persists.
F-05, F-06, F-07, F10, F11, F24, F25	There may be a problem with an internal component.	Try to clear the error by turning the range off, and then on. Contact Vollrath Technical Services if the problem persists.
F-08	The range may have overheated due to insufficient airflow.	Make sure the equipment has adequate airflow. See the Clearance Requirements section in this manual. Verify the air intake under the equipment is not blocked. Contact Vollrath Technical Services if the problem persists.
F16	The sensor may have detected an empty pan was on the range for too long.	Remove the pan. Clear the error by turning the range off, and then on. Place only pans with food in them onto the range.
F17, F18	There may be an issue with the incoming power supply or there may have been a power surge.	Try plugging the range into an a electrical outlet that is on a different circuit. Contact Vollrath Technical Services if the problem persists.
F19, F20	There may be an issue with the incoming power supply quality.	Try plugging the range into an a electrical outlet that is on a different circuit. Contact an electrician to troubleshoot the electrical supply.
F22	The range is plugged into an outlet with the wrong voltage.	Make sure the power at the electrical outlet matches the rating tag on the underside of the range.
	A prolonged power surge.	Try to clear the error by unplugging, and then plugging in the range. Resume operation. Contact Vollrath Technical Services if the problem persists.
F23	The range is plugged into an outlet with the wrong voltage.	Make sure the power at the electrical outlet matches the rating tag on the underside of the range.
	A prolonged dip in the power supply	Try to clear the error by unplugging, and then plugging in the range. Resume operation. Contact Vollrath Technical Services if the problem persists.
HOT	The user turned off the range. The cooking surface is still hot.	This is normal operation.
Cookware is not Heating		
The range turned off after 10 minutes.	There is not a pot or pan on the induction range or it is not induction-ready cookware, so the induction range turned off. This is normal.	Verify the cookware is induction ready. See the Cookware Requirements section of this manual.
The pan suddenly stopped heating. No power level or temperature is displayed.	The timer was in use and time expired. The range stopped heating the pan.	This is normal. A program that includes a timer stage may have been in use or the timer may have been inadvertently activated.
Vollrath logo is not illuminated even though the range is plugged in.	There may be problem with the electrical supply.	Try plugging another piece of equipment into the outlet to verify the outlet is working. Verify the voltage at the outlet matches the voltage rating on the nameplate located on the underside of the range.
	The fuse may need to be replaced.	See "Fuse Instructions" on page 11.
Temperature Control Probe Issues		
The temperature on the display does not increase as the food heats.	This normal.	The display shows the selected temperature. It does not display the temperature of the food.
The temperature on the display does not match the temperature of food when checked with a food thermometer.	Temperature control probe may be placed incorrectly in the food.	Make sure the probe is in the center of the food and is not touching the bottom of the cookware.
	Food thermometer and temperature probe may have been inserted into different areas of the food.	For even heating and food quality, stir the food often.
The temperature probe icon is blinking.	This is normal.	The food is heating to the set temperature.

TROUBLESHOOTING (CONTINUED)

Problem	Might be Caused By	Course of Action
Food Not Heating as Expected		
Food is not heating evenly or seems to be taking too long to heat.	There could be an issue with the cookware.	Verify the cookware is compatible. See the Cookware Requirements section in this manual.
	The food may need more time to heat to the desired temperature.	For faster heating times, try using power level mode instead of temperature mode.
	The cookware may be too large.	With induction cooking, only the area of a pan that makes contact with the induction coil will heat.
	Trying to heat too much food at once.	In general, larger amounts of food take longer to heat. For faster heating times, try heating less food at a time. For best performance, stir food often.
	Insufficient airflow around the range.	Refer to the Clearance Requirements section of this manual.
	Ambient temperature may be too high.	
	The cooking application may not match the intended use of the range.	Vollrath offers induction ranges with different wattages and features designed to fit a variety of applications. Visit Vollrath.com for more information.
Noise		
Grinding, ticking noise, rattle sound coming from the vents.	There may be a problem with the fans.	Contact Vollrath Technical Services.
The fan is running. The range is turned off.	This is normal. The fans will run until the internal components have cooled.	Normal operation.
Range Does Not Turn On		
Range is plugged into a working electrical outlet with correct voltage, but the Vollrath logo is not illuminated.	The fuse may need to be replaced.	See "Fuse Instructions" on page 11.
Programs Editor		
Programs editor does not open.	Java may not be installed on the computer or may need to be updated.	Download a free version of Java.

FUSE INSTRUCTION

The Troubleshooting section of this manual describes situations in which the fuse may need to be replaced.

Determine Type of Fuse

- Internal Fuse - Contact Vollrath Technical Services for support. Internal fuse cannot be serviced by customer.
- External Fuse - proceed to the Tools You Will Need Section to replace fuse.

EXTERNAL FUSE REPLACEMENT

Tools You Will Need

- Small screwdriver.
 - Towel or soft cloth.
 - 314 20A fuse (Available on Vollrath.com and found at most hardware stores).
1. Turn off and unplug the induction range.
 2. Place a towel or soft cloth on a flat, stable surface.
 3. Gently and carefully, lay the induction range, glass-side down, onto the towel. Locate the fuse cap.

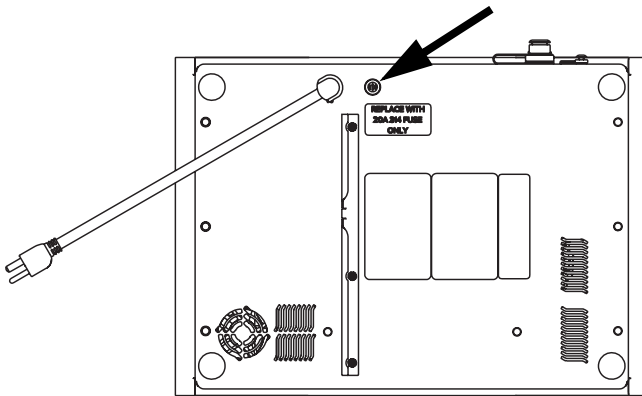

4. Using screwdriver; press down and turn the fuse holder cap to release it from the range.

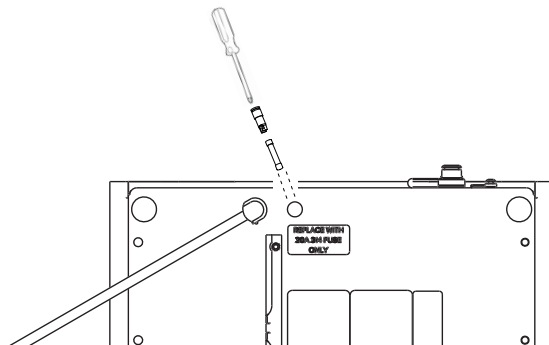

5. Remove the fuse from the holder.
6. Insert a replacement fuse into the holder.
7. Re-insert the holder and use the screwdriver to secure the cap into the range.
8. Ensure the cap holder is locked into place.

INTERNAL FUSE REPLACEMENT

Note: If induction range has an internal fuse you must contact Vollrath Tech Services for support. Internal fuse cannot be serviced by customer.

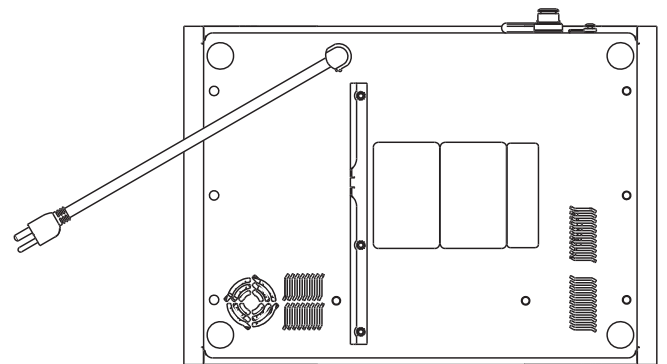

FCC STATEMENT

This equipment has been tested and found to comply with Part 18 of FCC Rules. These limits are designed to provide reasonable protection against harmful interference in a residential installation. This equipment generates, uses and can radiate radio frequency energy and, if not installed and used in accordance with the instructions, may cause harmful interference to radio communications. However, there is no guarantee that interference will not occur in a particular installation. If this equipment does cause harmful interference to radio or television reception, which can be determined by turning the equipment off and on, the user is encouraged to try to correct the interference by one or more of the following measures:

- Reorient or relocate the receiving antenna
- Increase the separation between the equipment and receiver
- Connect the equipment into an outlet on a circuit different from that to which the receiver is connected
- Consult the dealer or an experienced radio/TV technician for help

To assure continued compliance, any changes or modifications not expressly approved by the party Responsible for compliance could void the user's authority to operate this equipment.

SERVICE AND REPAIR

Serviceable parts are available on Vollrath.com.

To avoid serious injury or damage, never attempt to repair the unit or replace a damaged power cord yourself. Do not send units directly to The Vollrath Company LLC. Please contact Vollrath Technical Services for instructions.

When contacting Vollrath Technical Services, please be ready with the item number, model number (if applicable), serial number, and proof of purchase showing the date the unit was purchased.

WARRANTY STATEMENT FOR THE VOLLRATH CO. L.L.C.

The warranty period is 2 years. See Vollrath.com for full warranty details.

This warranty does not apply to products purchased for personal, family or household use, and The Vollrath Company LLC does not offer a written warranty to purchasers for such uses.

The Vollrath Company LLC warrants the products it manufactures or distributes against defects in materials and workmanship as specifically described in our full warranty statement. In all cases, the warranty runs from the date of the end user's original purchase date found on the receipt. Any damages from improper use, abuse, modification or damage resulting from improper packaging during return shipment for warranty repair will not be covered under warranty.

For complete warranty information, product registration and new product announcement, visit www.vollrath.com



www.vollrath.com

The Vollrath Company, L.L.C.

1236 North 18th Street
Sheboygan, WI 53081-3201 U.S.A.
Main Tel: 800.624.2051 or 920.457.4851
Main Fax: 800.752.5620 or 920.459.6573
Customer Service: 800.628.0830
Canada Customer Service: 800.695.8560

Technical Services

techservicereps@vollrathco.com
Induction Products: 800.825.6036
Countertop Warming Products: 800.354.1970
Toasters: 800-309-2250
All Other Products: 800.628.0832