



**Vogt Tube-Ice®
Large Size Machines
P34HL**

Manual Part Number 12A4171M18

Vogt Ice®, LLC
1000 W. Ormsby Ave.
Suite 19
Louisville, KY 40210 USA
Since 1880

Sales + Service: 1-502-635-3000
Parts: Your Local Distributor
SuperCare Technical: 1-502-635-3510 or 1-502-635-3052

Service Manual
\$50.00 USD

Important Safety Information



Any improper attempt to repair major equipment may result in personal injury, property damage, or loss of life. Before installing, operating, adjusting, or servicing the HFO10, please read this manual and become familiar with its contents, understand the operation of this machine, and be aware of possible dangers.

Safety Symbols and What They Mean

Heed the following safety symbols, which may appear in this manual and/or on the machine.

Symbol	Meaning
	Danger: Indicates an immediate hazard and that special precautions are necessary to avoid severe personal injury or death.
	Warning: Indicates a strong possibility of a hazard and that an unsafe practice could result in severe personal injury.
	Caution: Indicates that hazards or unsafe practices could result in personal injury or damage to product or property.

NOTICE

This manual belongs to the owner of the following Vogt Ice machine:

Model # _____ Serial # _____

This manual must remain on the premises with the above-listed machine at all times. After machine start-up, store the manual in a safe place where it can be readily available for future reference in maintaining, troubleshooting, or servicing the machine. Designate a person to be responsible for the manual.

Failure to comply with this notice will result in unnecessary inconvenience and possible additional expenses.

This manual is designed to assist with the installation, start-up, operation, maintenance, troubleshooting, and servicing of this equipment. This Tube-Ice® machine is designed to provide a lifetime of service when installed, maintained, and serviced properly.

This information is intended for use by individuals with adequate backgrounds in electrical, refrigeration, and mechanical expertise. Neither the manufacturer nor seller is responsible for the interpretation of this information, nor can they assume any liability in connection with its use.

If a situation calls for additional information not found in this manual, contact your distributor. If further assistance or information is needed, contact the factory by calling 1-502-635-3000 or faxing 1-502-635-3024.

Please read this manual carefully before attempting installation, operation, or servicing of this professionally designed piece of equipment.

The SuperCare group at Vogt Ice, LLC, provides assistance for all customer service needs, including part sales and warranty support. SuperCare also conducts training schools at the factory and can offer onsite training if needed.

The model and serial number of this Vogt equipment is located on the nameplate attached to the electrical control panel. If an electrical control panel was not furnished with this machine, the nameplate is located on the equipment frame or paneling. To enable SuperCare to handle your questions quickly and accurately, refer to the model and serial number when making inquiries about this machine.

Warranty Registration/Start-Up Form

The Warranty Registration/Start-Up Form on the next page must be completed and returned to Vogt Ice, LLC, within 2 weeks after the official start-up of the machine to initiate and ensure a full warranty. The form must be completed and either mailed to the address below, scanned and emailed to info@vogtice.com, or faxed to 1-800-770-8648. This form is also available online at www.vogtice.com/warrantyregistration/.

Please mail the completed form to:

Vogt Ice, LLC
1000 W. Ormsby Ave.
Suite 19
Louisville, KY 40210 USA

Table of Contents

P34HL Large Size Ice Machine

Important Safety Information	3
Safety Symbols and What They Mean.....	3
NOTICE.....	4
Warranty Registration/Start-Up Form.....	4
Chapter 1 Introduction	1-1
Chapter 2 How the P34HL Machine Works	2-1
Principles of Operation	2-1
Model Number	2-2
Piping	2-3
Freezing Period	2-6
Harvest Period	2-6
Refrigeration System Overview of Optionally Supplied HFOPAK50.....	2-7
Charging Refrigeration Systems	2-8
Chapter 3 Receipt of Machine	3-1
State of New Machine	3-1
Inspection	3-1
Delivery Inspection Checklist.....	3-1
Safety Tags and Labels.....	3-1
Pressure Relief Valves.....	3-1
Machine Location	3-2
Equipment Storage	3-2
Rated Capacity.....	3-2
Chapter 4 Installation of the P34HL	4-1
Machine Connections.....	4-1
Equipment Layout and Service Access	4-5
Lifting Procedures.....	4-7
Equipment Anchoring.....	4-11
Piping and Drain Connections	4-12
Cooling Tower (Optional)	4-12
Pressure Relief Valves.....	4-12
Wiring and Electrical Connections.....	4-13
Phase Check.....	4-14
Voltage Imbalance	4-14
Current Imbalance	4-15
Ice Bin Thermostat Sensor.....	4-15
Installation Checklist.....	4-16
Chapter 5 Start-Up, Shutdown, and Operation	5-1
Start-Up Checklist	5-1
Start-Up Procedure (Initial Start-Up).....	5-1
Shutdown Procedure.....	5-2
Start-Up and Shutdown Tips	5-2
Ice Quality.....	5-2

Adding Refrigerant.....	5-3
Chapter 6 Electrical Controls and Their Functions	6-1
Allen Bradley PLC with Touch Screen HMI	6-6
HMI Main Menu	6-6
For Optionally Supplied HFOPAK50 Remote High Sides	6-8
HMI Primary Submenus.....	6-8
HMI Home Screen.....	6-13
For Optionally Supplied HFOPAK50 Remote High Sides	6-15
HMI Detailed Screens	6-16
Control Panel Details	6-31
Chapter 7 Maintenance	7-1
Cleaning	7-1
Water Distributors.....	7-4
Water Tank.....	7-6
Freezer Cover	7-6
Water-Cooled Condensers	7-6
Chemical Cleaning	7-7
Mechanical Cleaning	7-8
Lubrication of the Cutter Motor Gear Reducer	7-9
Preventive Maintenance	7-10
Daily Checklist.....	7-10
Weekly Checklist.....	7-10
Monthly or Yearly Checklist.....	7-10
Preventive Maintenance Form	7-12
Chapter 8 Troubleshooting	8-1
Machine Not Running.....	8-1
Freeze-Up from Extended Freeze Period	8-2
Freeze-Up from Ice Failing to Discharge.....	8-3
Poor Ice Quality	8-4
Low Ice Capacity	8-4
High Head Pressure (Water-Cooled Machines).....	8-5
Chapter 9 Servicing Operations	9-1
Automatic Blowdown	9-1
Makeup Water Float Valve.....	9-1
Hand Expansion Valve	9-1
Freezer Pressure Switch on Touch Screen HMI.....	9-1
Freeze Timer on Touch Screen HMI	9-1
Low Pressure Safety on Touch Screen HMI	9-1
High Pressure Safety on Touch Screen HMI	9-2
Head Pressure Control.....	9-2
Control Circuit Protection.....	9-2
Harvest Timer	9-2
Pumpdown	9-3
Refrigerant Leaks	9-4
Non-Condensable Gases.....	9-4
Valve Stations	9-5
Capacitive Level Control	9-6
Set Point and Operation	9-7

Low Level Adjustment 9-7
Control Level Adjustment..... 9-7
High Level Adjustment 9-8
Simulation..... 9-8
Recalibration 9-8
Circulating Water Pump Motor 9-10
Cutter Gear Reducer 9-11
Cutter Motor Replacement 9-11
Drive Gear Replacement..... 9-11
Gear Reducer Replacement..... 9-12
Water Tank Removal 9-13
Cutter Assembly Removal and Reinstallation 9-14
Bearing Bracket and Cutter Disc Removal 9-14
Cutter Shaft and Bearing Removal 9-14
Cutter Ring Gear Replacement..... 9-15
Cutter Blade Replacement..... 9-15
Cutter Adapter Plate Installation..... 9-16
Cutter Shaft and Bearing Installation 9-16
Cutter Height Adjustment 9-17
Water Tank Installation 9-17
Circulating Water Pump Motor 9-21
Crushed Ice Production 9-21

Appendix A Optional Accessories A-1
Power Monitor, Wagner Model DTP-3..... A-1
The Display A-1
Adjustment of Parameters in Order of Display A-2

Appendix B Tables..... B-1

Appendix C Additional Documentation C-1

Chapter 1 Introduction

Since Vogt introduced Tube-Ice® machines in 1938, the process of making Tube-Ice® ice has been widely recognized as the most economical means of ice production. These machines' economic and reliable operation has been proven repeatedly in a variety of installations throughout the world. The skill in engineering and fabrication Vogt Ice has learned in more than eight decades of experience is reflected in your machine.

Using as little as one-third of the energy required by competing ice makers, Tube-Ice® machines produce the same amount of ice at great savings—in restaurants, sports arenas, packing plants, and wholesale operations around the world.

In addition, Tube-Ice® machines are renowned for their long service life, giving many customers more than 35 years of dependable service. Ask someone who owns one.

The P34HL machine was introduced in 2021 as the next evolution of the Tube-Ice machine. It was developed to provide end users with a long-term synthetic refrigerant solution for low side ice makers.

Hydrofluorocarbon (HFC) refrigerants are experiencing a phase-out in a variety of markets across the globe because of their high Global Warming Potential (GWP). This forces Original Equipment Manufacturers (OEMs) to build forward-thinking business strategies when selecting a replacement refrigerant for use in their equipment.

The challenge with implementing synthetic refrigerants in ice machines is to find the perfect balance between something that will work well in the application and be available for purchase for the foreseeable future. Finding this balance has been Vogt's focus.

Vogt's long-term refrigerant solution is HFO (hydrofluoroolefin) blends with similar properties as R134a. These HFO-based refrigerants have very low GWPs, which are in line with the European Union F-Gas Regulation phase-down and with projected refrigerant regulations in the United States.

In November 2017, at the International Packaged Ice Association convention, Vogt introduced the HFO10 mid-size self-contained machine. It is the first Tube-Ice machine designed to run on an HFO blend (R-513A). This blend, along with other R134a-like HFO blends, is expected to be a long-term synthetic refrigerant solution. However, HFO blends are likely to be replaced by pure HFO refrigerants of the R1234-family. These pure HFOs will be retrofittable to the P34HL machine, giving it a secure and well-defined future as the market evolves.

The P34HL is the continuation of Vogt's new focus to innovate and introduce superior products to the marketplace.

Chapter 2 How the P34HL Machine Works



Warning: Only service personnel experienced and certified in refrigeration and qualified to work with high-voltage electrical equipment should be allowed to install or work on this Tube-Ice® machine.

Principles of Operation

Manual operation of the machine is controlled by the **Off**, **Ice**, and **Start** touch screen buttons on the **Home** screen of the HMI. These buttons appear on the default screen when power is supplied to the machine.

Note: Further references in this manual to the **Off**, **Ice**, **Start**, or **Run Water Pump** buttons are found on the **Home** screen of the HMI. See Chapter 6.

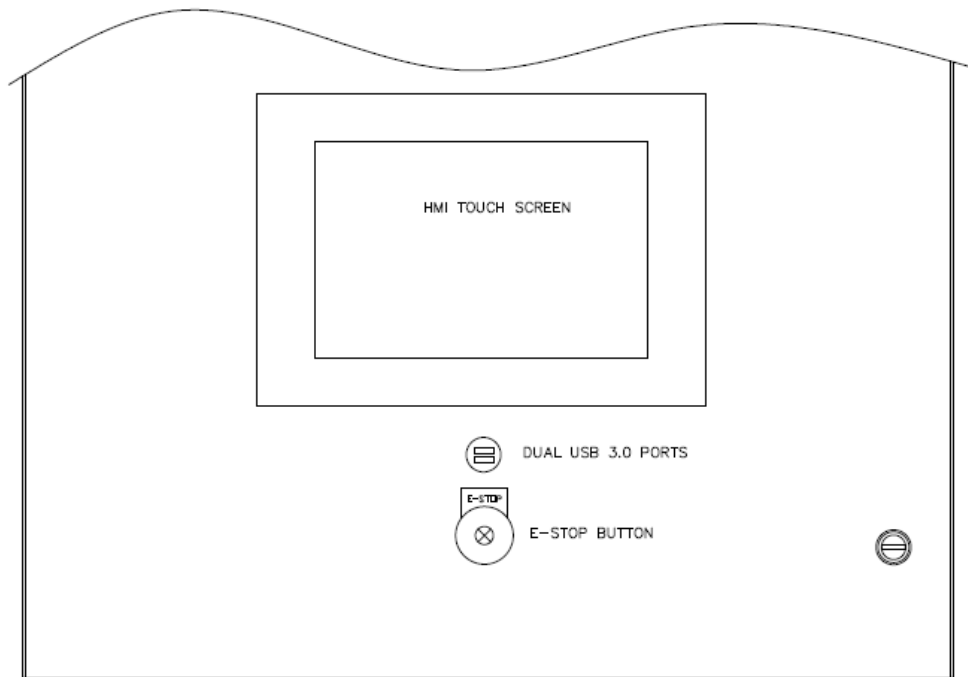

Figure 1: Control Panel Door

Automatic operation is controlled by the standard ice bin thermostats, which stop and start the ice maker based on the level of ice in the storage bin.

The length of ice produced is determined by how the machine cutter is set.

The unit will only stop when a thawing (harvest) period has been completed, whether by the pressing the **Off** touch screen button or the ice bin thermostat. To stop the machine instantly, push the **E-Stop** button. To restart the machine, turn the **E-Stop** button clockwise, clear the **E-Stop** fault on the touch screen, and push the **Start** touch screen button.

Model Number

The machine nameplate is located on the left side of the control panel. The model number and machine descriptions are located in the top left-hand corner. Figure 2 can be used to verify that the correct model has been received.

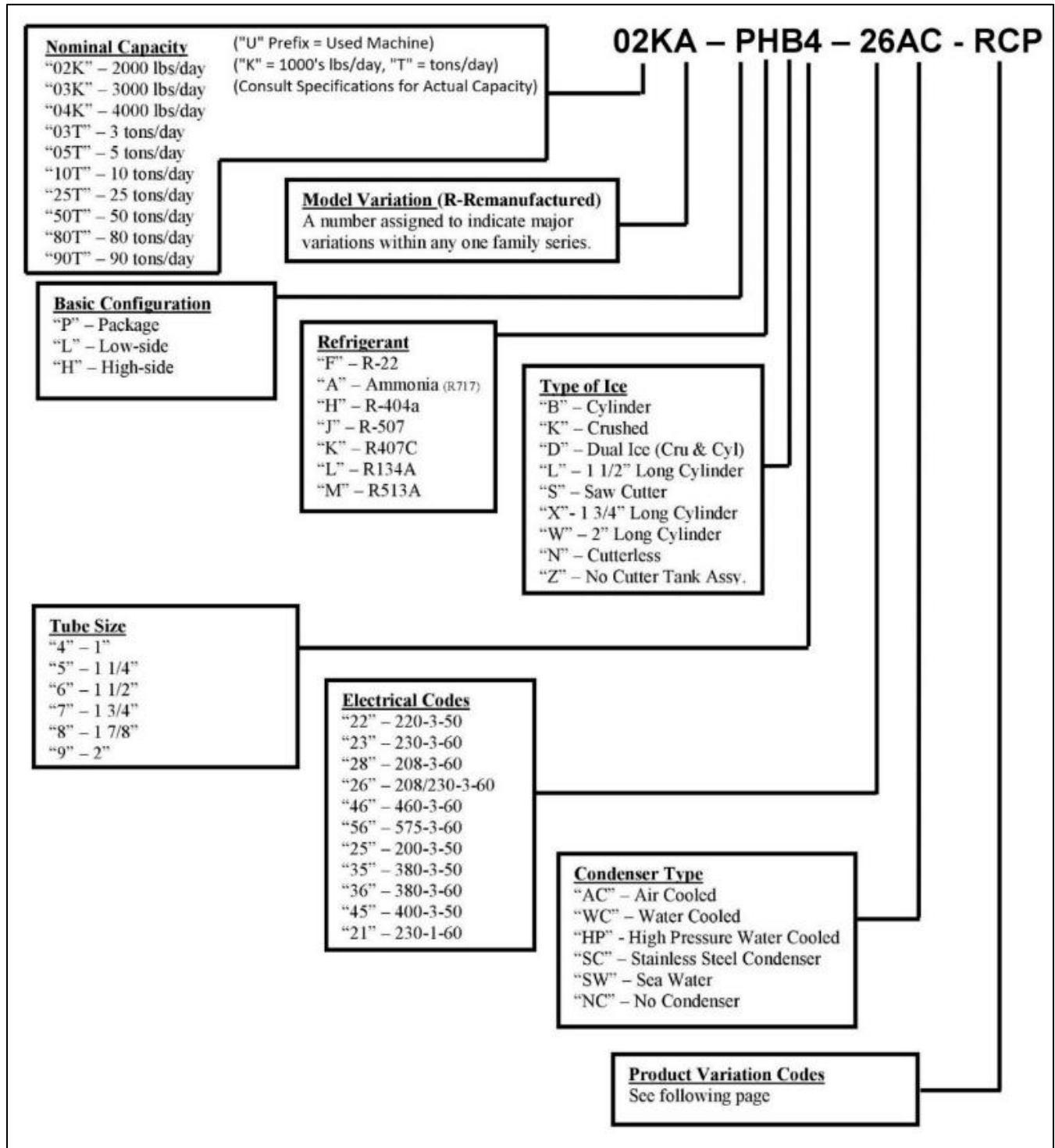

Figure 2: Vogt Model Nomenclature

Piping

Table 1 lists the piping nomenclature as labeled in Figure 3 and Figure 4, which illustrate the piping schematics of the refrigerant and water circuits of water- and air-cooled Tube-Ice® machines.

Table 1: P34HL and Optional HFOPAK50 Piping Nomenclature

	Description		Description
T	Make-Up Water Thermometer	52	3-Way Valve
6	Recirculating Water Pump	58	Liquid Isolation Valve (King Valve)
12	Make-Up Water Float Valve	59	Receiver Purge Valve
17	Main Liquid Line Valve Station	61	Freezer Drain Valve
18	Main Thaw Gas Valve Station	62	Make-Up Water Inlet Valve
18A	Auxiliary Thaw Gas Valve Station	63	Solenoid Flush Valve
20	Liquid Line Bypass Valve Station	65	Level Column Probe
28	Freezer Charging Valve	67	Level Column Sight Glass
31	Level Column Isolation Valve	69	Accumulator Access Valve
31A	Level Column Drain Valve	70	Oil Return Isolation Valve
35	Discharge Isolation Valve	76	Freezer Purge Valve
39	Water Tank Drain Valve	90	Thaw Gas Isolation Valve
43	Strainer	91	Liquid Return Isolation Valve
44	Receiver Drain Valve	92	Equalizer Line Isolation Valve
45	Liquid Line Purge Valve	101	Thaw Gas Check Valve
51	Relief Valve		

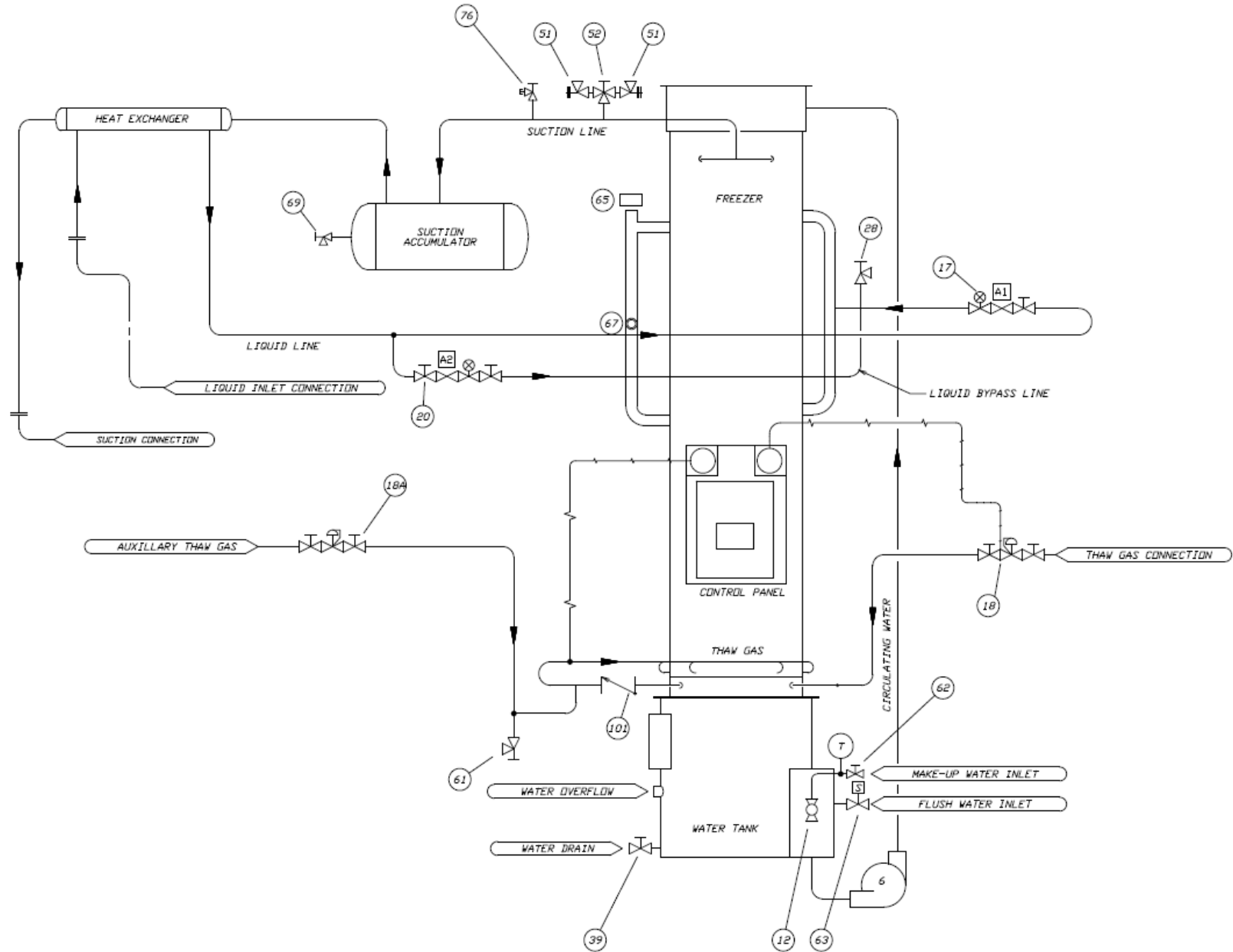

Figure 3: P34HL Low Side Only Piping Schematic

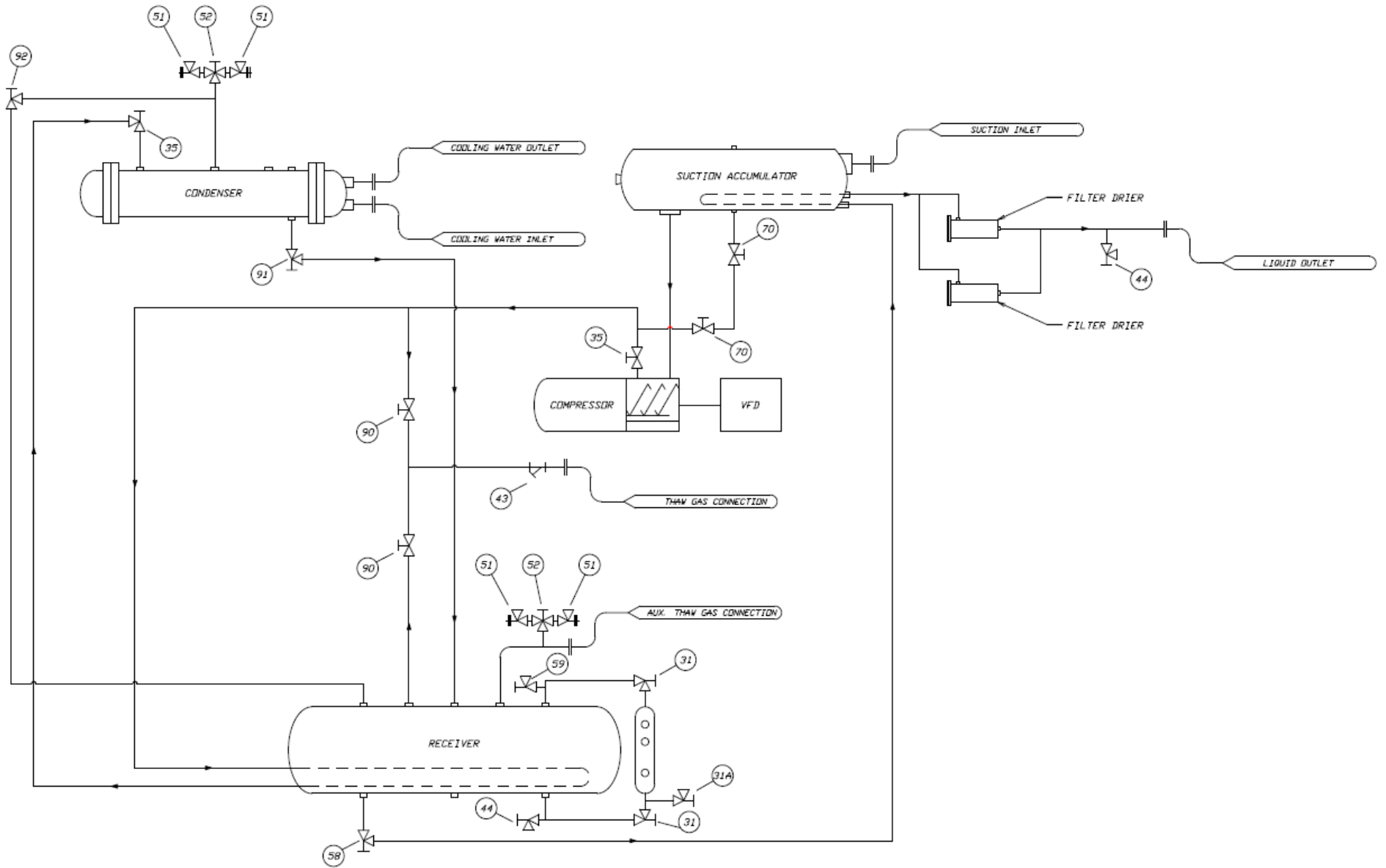

Figure 4: Optional HFOPAK50 High Side Piping Schematic for P34HL

Freezing Period

The freezer is a shell-and-tube type vessel, consisting of an outside shell with vertical tubes inside. Water freezes inside the tubes by the direct application of refrigerant to the shell side (outside) of the tubes. Ice is produced as the water continues to recirculate. As the ice thickens, the freezer suction pressure decreases. The **Freezer Pressure Switch** automatically initiates the thawing, or harvest, period as the freezer pressure reaches the setpoint in the PLC. The machine can also be set to run on the **Freeze Timer**. Refer to *Freezer Pressure Switch on Touch Screen HMI* and *Freeze Timer on Touch Screen HMI*.

During the freezing period:

1. Water is constantly recirculated through the freezer tubes by a centrifugal pump.
2. Makeup water is maintained at the appropriate level by a float valve in the water tank.
3. A liquid line solenoid valve (A) is open, and a thaw gas solenoid valve (D) is closed.
4. Refrigerant gas from the top of the freezer passes through the suction accumulator, the heat exchanger, and on to the remotely installed compressor package.
5. The following steps occur on optionally supplied HFOPAK50 remote high sides:
 - a. The cool gas is compressed to a high-temperature, high-pressure gas that discharges through the oil separator and into the condenser.
 - b. In the condenser, heat is removed, and the gas is condensed to a high-temperature, high-pressure liquid.
 - c. This high-pressure liquid goes through the accumulator boil-out coil and suction line heat exchanger, where it gives up heat to the suction gas for compressor protection.
 - d. This liquid is subcooled and carried to the receiver.
 - e. Condensed liquid refrigerant from the receiver flows through the thawing chamber of the freezer, the filter/dryer, the liquid line solenoid valve (A), and then the expansion valve and capillary.
6. At the expansion valve and capillary feed, the refrigerant expands from a saturated liquid state of relatively high pressure to a very low-pressure, low-temperature liquid.
7. The electronic liquid level indicator is wired to the liquid line solenoid valve (A).
8. The electronic liquid level indicator energizes and de-energizes the liquid line solenoid valve (A) in response to the level of refrigerant in the freezer.
9. The cold liquid refrigerant enters the freezer, where it absorbs heat from the circulating water.
10. This cool gas is pulled out of the freezer at the suction outlet, thereby completing the circuit.

The freezing period is completed by the **Freezer Pressure Switch** or by the **Freeze Timer** in the PLC.

1. The water pump stops, and the liquid line solenoid valve (A) closes.
2. The thawing (harvest) period begins.

Harvest Period

During the harvest period:

1. The PLC stops the water pump, closes the liquid line solenoid valve (A) and starts the **Harvest Timer**.
2. The cutter motor starts after an adjustable **Cutter Delay** and the thaw gas solenoid valve (D) opens after an adjustable **Thaw Gas Valve Delay**.
3. The adjustable Thaw Gas Valve setpoints stored in the PLC open and close the thaw gas solenoid valve (D) valve to maintain the proper pressure for ice to release without adding unnecessary heat.
4. Warm gas from the receiver or main compressor discharge line enters the freezer through the valve, and the outer edge of the ice slightly thaws for sizing by the rotating cutter.
5. As the ice releases and drops through the rotating cutter and onto the cutter disc, it discharges through the side opening of the water tank.
6. The **Harvest Timer** is set for the time required to discharge all the ice plus 30 seconds (can be up to 5 minutes).

CAUTION

To prevent refreezing, make sure all ice clears the freezer with at least 30 seconds to spare before the next freezing period begins.

Refrigeration System Overview of Optionally Supplied HFOPAK50

The HFOPAK50 is designed to operate on the hydrofluoroolefin (HFO) blend refrigerant R-513A.

It contains:

- Bitzer semi-hermetic compact screw compressor with integral oil separator
- Electronic refrigerant liquid level controller
- Expansion valve
- Flooded evaporator (freezer)
- Hot gas defrost

As shown in the piping schematic, the compressor discharge gas leaves the compressor and goes into the condenser. Here, the gas is condensed into liquid as heat is removed from the water as it passes through the condenser during the freezing period.

A reservoir of liquid is accumulated in the receiver and flows as required, passing through the coil in the suction accumulator and then through the filter/dryers. The liquid line solenoid valve (A) on the P34HL opens and closes in response to the liquid level in the freezer, as determined by the electronic liquid level controller on the side of the freezer.

Liquid refrigerant floods the evaporator and comes in contact with the outside of the ice-making tubes through which water is being circulated. The heat contained in this water passes through the walls of the tubes, lowering the temperature of the water, causing it to freeze and to form a long tube of ice that adheres to the inside of each freezer tube. Since the purest water freezes first, the flowing water keeps the accumulated ice clear by washing separated solids down into the sump area of the water tank. The blowdown valve on the circulating water pump discharge helps to rid the water tank of increased dissolved solids found in harder water by flushing them out of the overflow during water pump operation.

During the harvest period, the water pump stops, therefore, all the water circulating in the freezer drops to the tank, the tank level increases, and the overflow will get rid of that extra water. The overflow is a hole at the top of the tank. Refer to Chapter 9 for more information about automatic blowdown.

The transfer of heat from the water to the liquid refrigerant causes it to boil and convert into a liquid-vapor mixture at the suction connection at the top of the freezer. This liquid-vapor mixture passes through the suction accumulator and suction line heat exchanger on the P34HL, which act as the first means of removing large refrigerant droplets. From there, the mixture passes through the main suction accumulator on the HFOPAK50, where liquid droplets are removed and boiled off from the internal heating coil. This removes the remaining refrigerant droplets that may have passed through the system to this point, providing ample protection for the screw compressor.

As the ice forms in the freezer tubes, the suction pressure steadily decreases until it reaches the **Freezer Pressure Switch** setpoint or the **Freeze Timer**, initiating the harvest period.

During the harvest period, the thaw gas solenoid valve (D) is open, allowing warm high-pressure gas from the receiver to enter the freezer. This heat melts a thin film from the outside of the ice, reducing the outside diameter slightly, allowing it to fall free from the freezer tubes. This period may last up to 5 minutes.

Note: Freezing times will vary, depending on makeup water temperature and setting of the freezer pressure switch. As you become more familiar with the operation of your machine, you will be able to recognize and correct minor irregularities as they occur, which will help prevent major problems.

Charging Refrigeration Systems

CAUTION

Only technically qualified persons, experienced and knowledgeable in the handling of refrigerant and operation of refrigeration systems, should perform the operations described in this manual.

All local, federal, and EPA regulations must be strictly adhered to when handling refrigerants. If a refrigeration system is being charged from refrigerant cylinders, disconnect each cylinder when empty or when the system is fully charged.

The P34HL is not supplied with a refrigerant charge, but rather a small holding charge of nitrogen at 25 psi (1.7 bar). If supplied, the optionally available HFOPAK50 is also shipped with only a small holding charge of 25 psi (1.7 bar).

A gauge should be installed in the charging line to indicate refrigerant cylinder pressure. The cylinder may be considered empty of liquid refrigerant when the gauge pressure is 25 psig (1.7 bar) or less, and there is no frost on the cylinder. Close the refrigerant charging valve and cylinder valve before disconnecting the cylinder. Loosen the union in the refrigerant charging line carefully to avoid unnecessary release of refrigerant into the atmosphere. Refer to local and national regulations.

CAUTION

Immediately close the system charging valve at the commencement of the defrost or thawing cycle if a refrigerant cylinder is connected. Never leave a refrigerant cylinder connected to the system except during charging operation. Failure to observe either of these precautions can result in transferring refrigerant from the system to the refrigerant cylinder, over-filling it, and possibly causing the cylinder to rupture because of pressure from expansion of the liquid refrigerant.

CAUTION

It is not recommended that refrigerant be transferred from a refrigeration system directly into a cylinder. If such a transfer is made, the refrigerant cylinder must be an approved, clean cylinder that is free of any contaminants or foreign materials. The cylinder must be connected to an approved recovery mechanism with a safety shutoff sensor to ensure that contents do not exceed the net weight specified by the cylinder manufacturer or any applicable code requirements.

Chapter 3 Receipt of Machine

CAUTION

Only service personnel experienced in refrigeration and qualified to work with high-voltage electrical equipment should install or work on this machine. Eye protection must be worn by all personnel working on or around the machine. You must be familiar with and adhere to all local ordinances and laws regarding the handling, storing, and use of refrigerants. Refer to the safety data sheet.

State of New Machine

The P34HL is a low side only ice-making machine. The machine was shipped with a nitrogen charge of 25 psi (1.7 bar). All valves on the machine are tagged as to their state (open or closed) and their purpose. The machine was cleaned with ice machine cleaner and flushed so that it is ready for ice production.

Inspection

Upon receipt of the Tube-Ice® machine, inspect it for any obvious damage. If damage is found or suspected, note it on the trucker's Bill of Lading. Immediately submit a separate written request for inspection by the freight line's agent. Any repair work or alteration to the machine without the permission of Vogt Ice, LLC, can void the machine's warranty. Also, notify your Vogt distributor or the factory.

Delivery Inspection Checklist

- Inspect outer casings (if provided)
- Inspect piping and valves
- Inspect refrigerant sight glass for damage

Visually check all lines for mechanical damage. If a leak is suspected, check all joints with a refrigerant leak detector supporting HFO blend refrigerants. All leaks should be reported to Vogt Ice, LLC, to obtain authorization and instructions for repair.

The machine is factory tested before shipment and supplied with a Certificate of Test report confirming the conditions under which it operated at the factory and that the machine operated as designed. Minor adjustment may be required at the installation site to achieve optimal performance.

Safety Tags and Labels

Be sure to read and adhere to all special tags and labels attached to valves or applied to various areas of the machine. They provide important information necessary for safe and efficient operation of your equipment. The unit may have valves in the open or closed position and may be tagged with information about the required position for start-up.

Pressure Relief Valves

Pressure relief valves are included on this Tube-Ice® machine. Two are located on the freezer (low-side). The optionally available HFOPAK50 remote high side includes six pressure relief valves – two on the suction accumulator, two on the condenser, and two on the receiver. Vent each of the pressure relief valves to the atmosphere in compliance with local and national codes.



Failure to do so creates a safety hazard that could cause injury or loss of life.

Machine Location

The machine must be located inside a suitable building and must not be subjected to ambient temperatures below 50°F (10°C) or above 110°F (43°C). Heat from other sources, such as sunlight, furnaces, condensers, or unusual air currents (including fans or air-conditioning air flow) may affect the operation of the machine and should be avoided. The electrical components of the Tube-Ice® machine are rated NEMA 1 or IP10. As such, the machine should not be located in a hazardous area or sprayed with water. The machine should be installed on a drainable condensate drip pan or in an area where there is no possibility of standing water, but readily drain away from the machine.

Equipment Storage

If the equipment must be stored before installation, it should be indoors and protected from extreme temperatures and high humidity. These conditions can deteriorate the various components used in the manufacture and assembly of the equipment.

CAUTION

This equipment contains the HFO refrigerant blend R-513A under pressure. Do not store in an area exposed to temperatures above 115°F (46°C) or in direct sunlight at temperatures above 105°F (40°C) with a charge of refrigerant.

Rated Capacity

This machine is rated to produce a given amount of ice when operating under the proper conditions as specified in this manual. Be prepared to handle the ice produced as it is discharged from the machine and move it to the storage or bagging area promptly.

Chapter 4 Installation of the P34HL

Machine Connections



Warning: Only service personnel experienced and certified in refrigeration and qualified to work with high voltage electrical equipment are allowed to install or work on this Tube-Ice® machine.

Preparing the machine for operation requires connecting the following to the appropriate locations on the machine:

- Electrical supply
- Makeup water supply
- Water blowdown drain

The diagrams on the following pages show the basic connection locations and orientation of the P34HL machine.

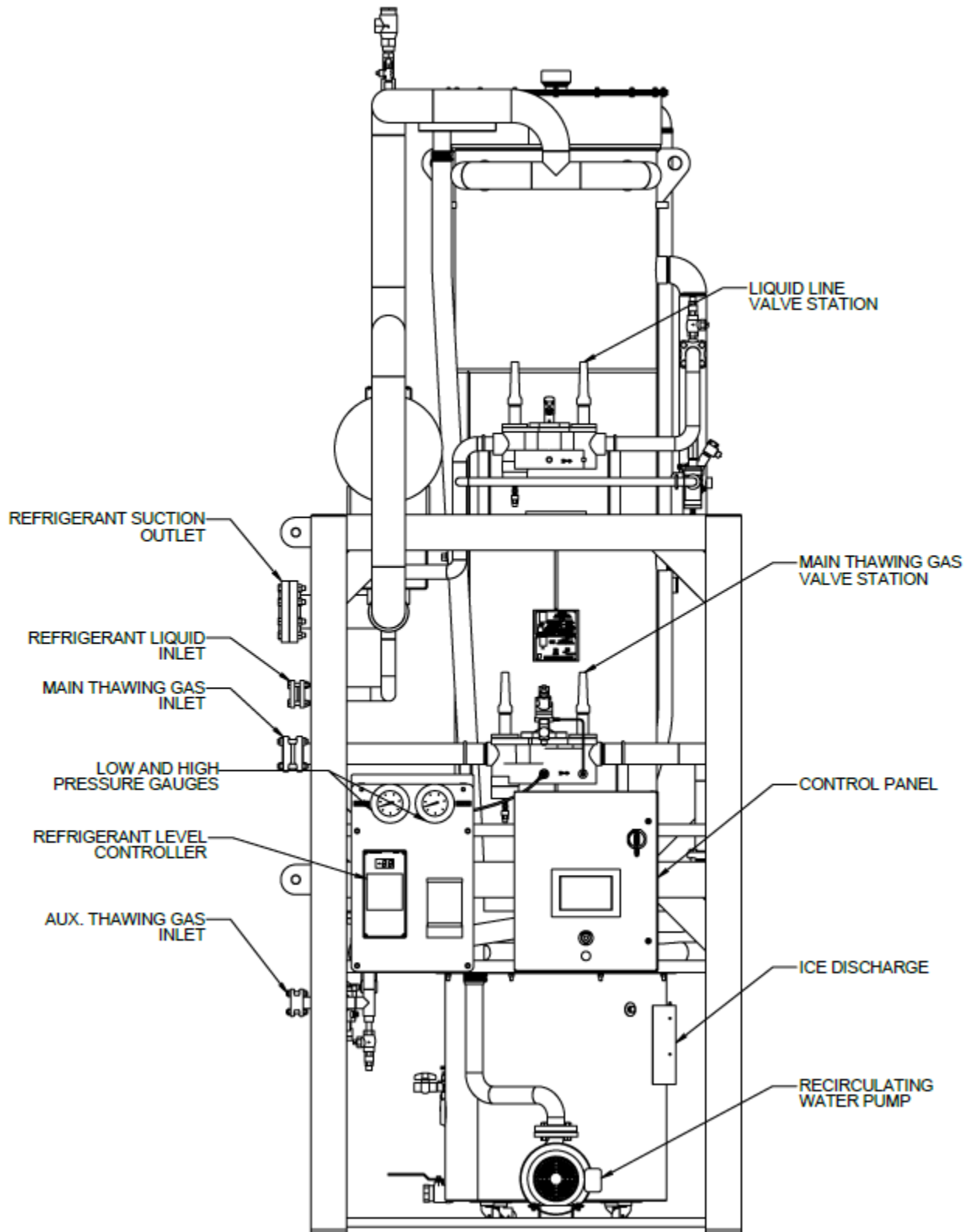

Figure 5: Assembly Front View

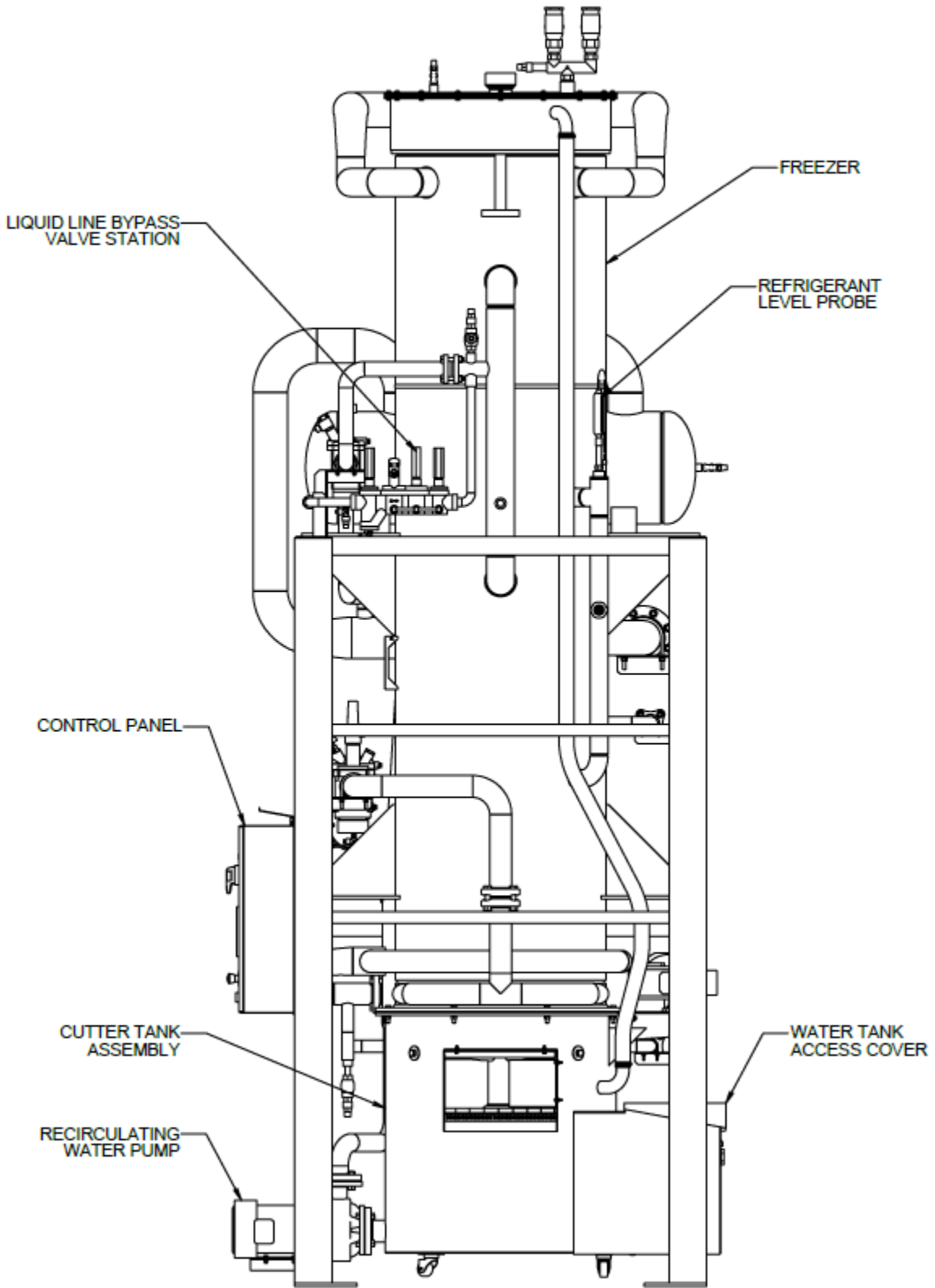

Figure 6: Assembly Right Side View

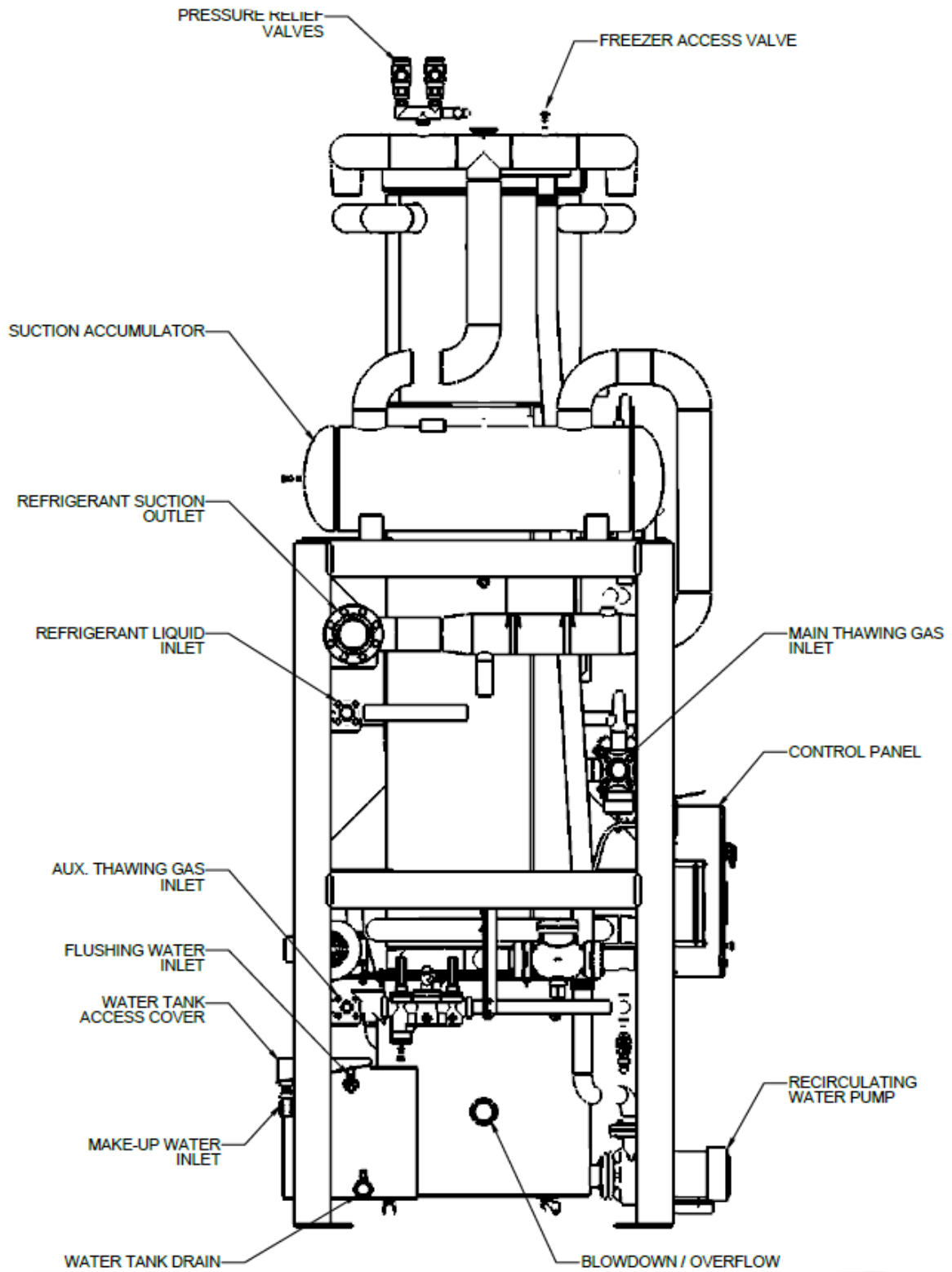

Figure 7: Assembly Left Side View

Equipment Layout and Service Access

CAUTION

The approximate operating weight for the P34HL is 11,350 lb (5,150 kg). The P34HL requires certain clearances around the unit for safety reasons and to provide access for servicing operations. Figure 8 and **Error! Reference source not found.** show clearance requirements.

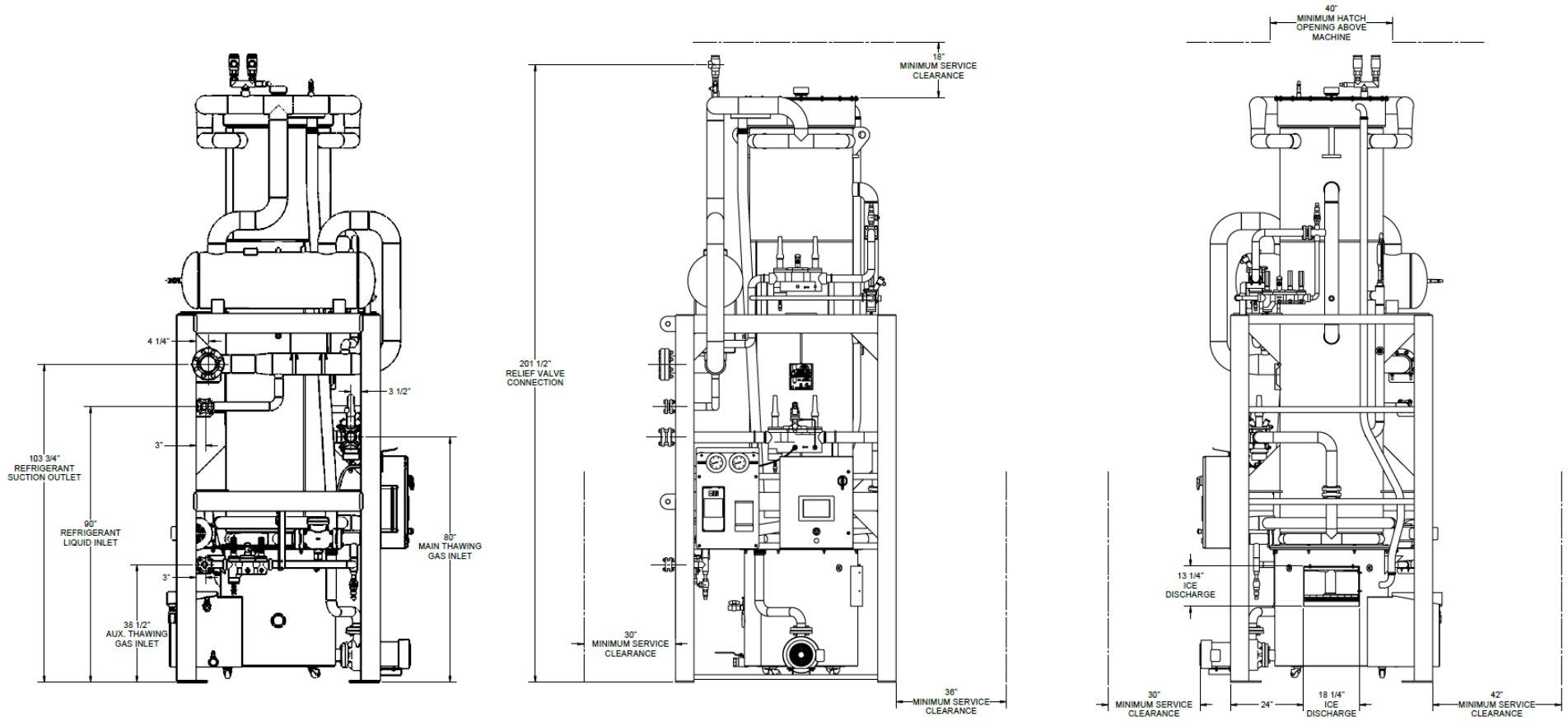

Figure 8: Connections and Clearance Diagram

Lifting Procedures



Warning: The machine weighs approximately 11,350 lb (5,150 kg). Use only the appropriate equipment with adequate loading capacity to move and install the machine.

The Tube-Ice® machine is top-heavy. The machine needs to be bound in place to prevent tipping.

Lift only from the top to avoid tipping. The machine frame has lifting lugs at each top corner for screw pin anchor shackle/eyebolt and hook to be used for lifting purposes. The lifting lugs should be used wherever possible.

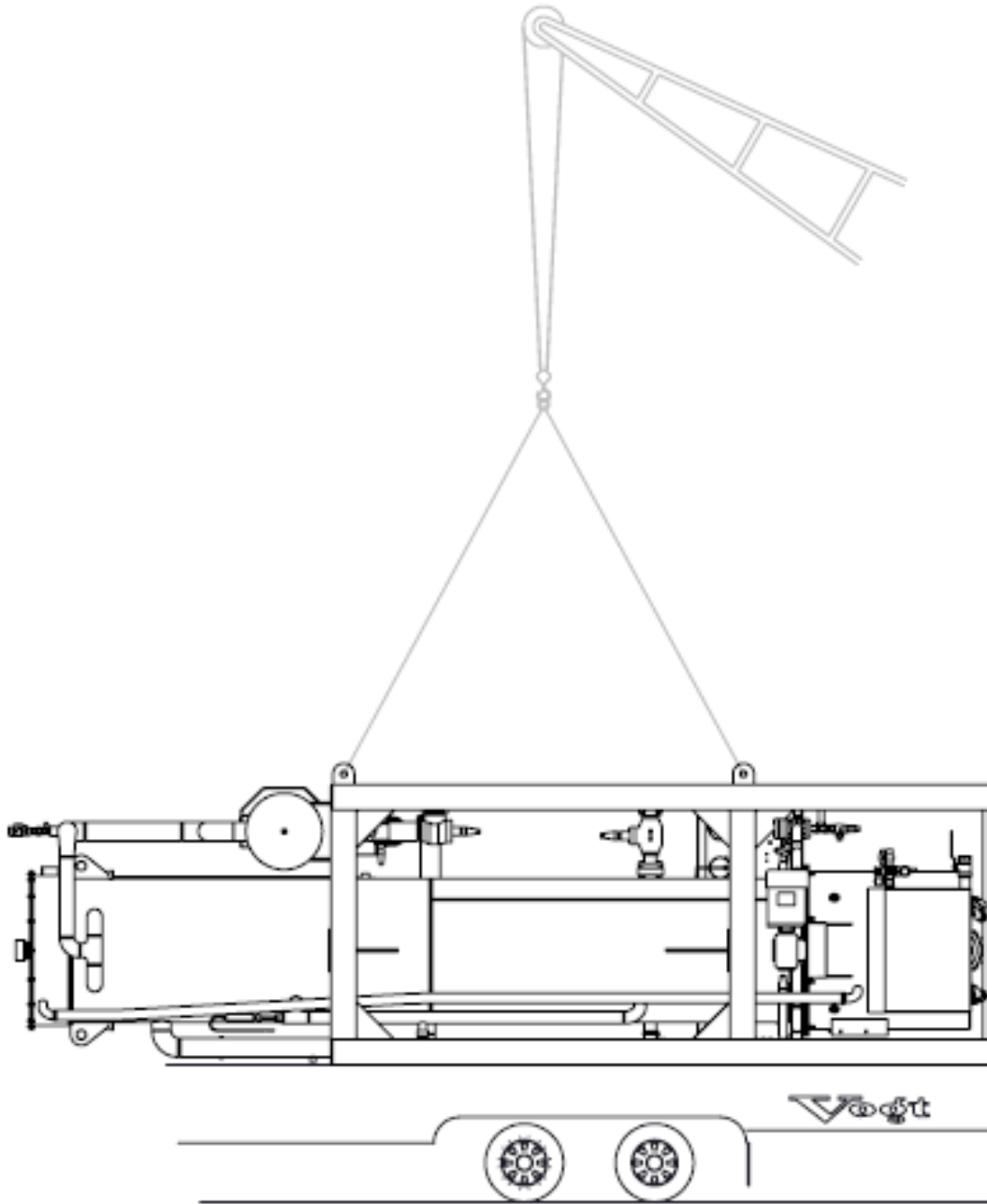

- LIFTING MACHINE FROM TRUCK -
1. CONNECT TO FREEZER LIFTING LUGS AS ILLUSTRATED (4 LUGS).
 2. LIFT MACHINE.
 3. MOVE MACHINE TO OPERATING SITE.

Figure 9: Machine Lifting Diagram – Step 1

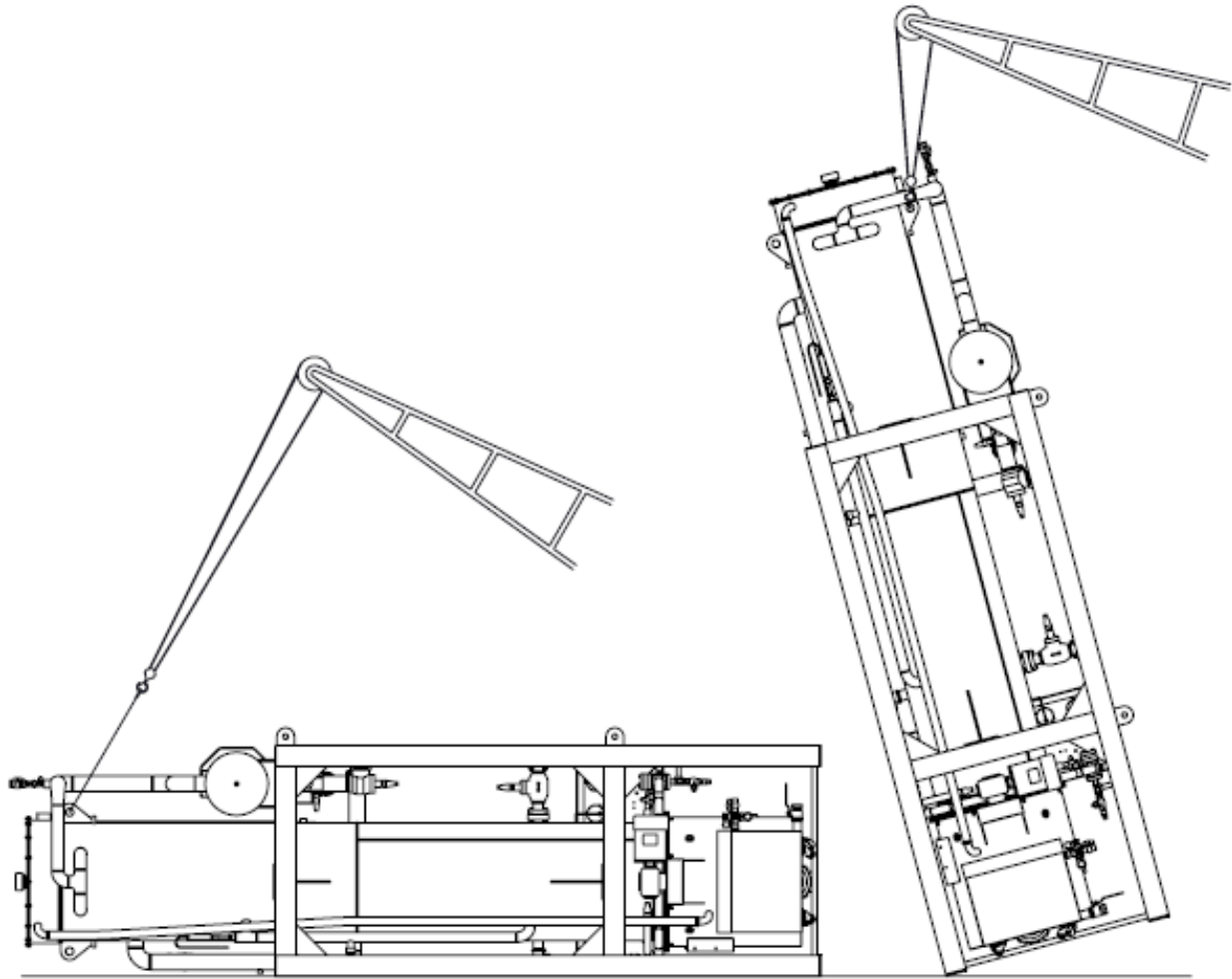

- LIFTING MACHINE UPRIGHT -
1. CONNECT TO FREEZER LIFTING LUG AS ILLUSTRATED.
 2. RAISE MACHINE SLOWLY. MACHINE WILL PIVOT ON BOTTOM SUPPORT BEAM.
 3. LOWER MACHINE TO AN UPRIGHT POSITION.

CAUTION -
POSITION CRANE CAREFULLY TO MINIMIZE SWING
WHEN MACHINE CLEARS GROUND.

Figure 10: Machine Lifting Diagram – Step 2

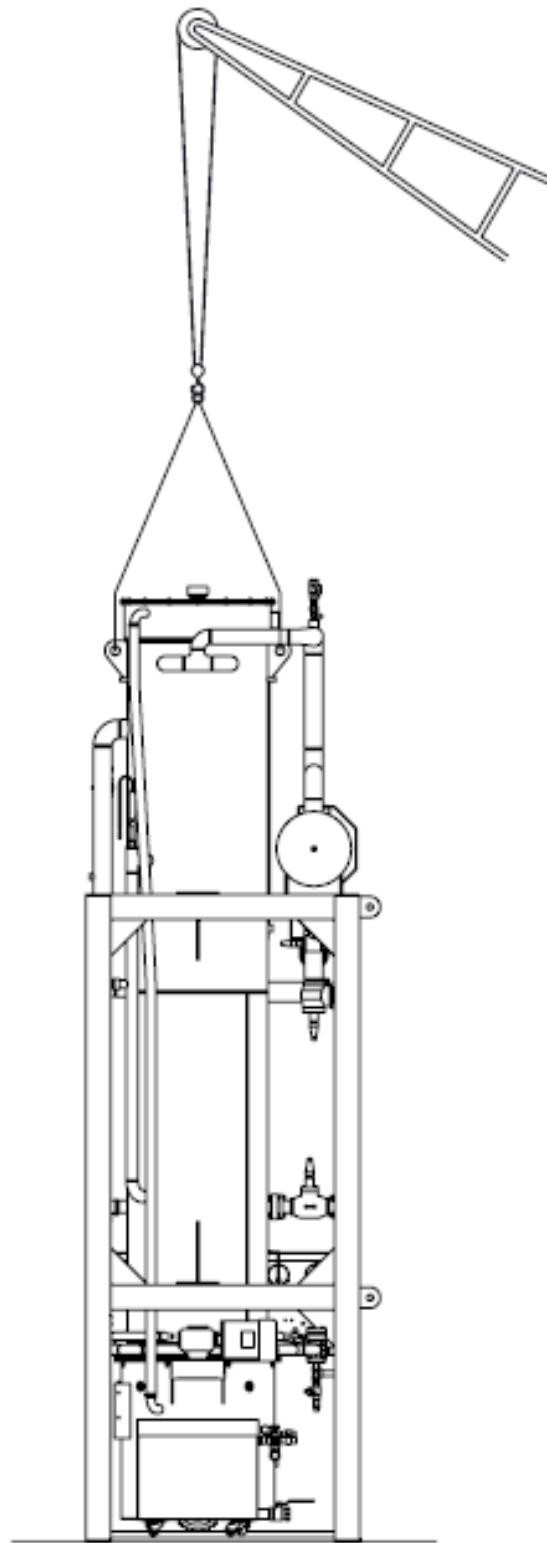

POSITIONING MACHINE -
LOWER MACHING TO OPERATING POSITION
USING ALL FREEZER LIFINTG LUGS.

KEEP CHAINS AND CABLES AWAY FROM
FREEZER COVER.

Figure 11: Machine Lifting Diagram – Step 3

Equipment Anchoring

The supporting foundation should be constructed from concrete or similar material in accordance with all local and federal codes and building regulations. Figure 12 indicates anchor bolt hole locations in the bottom frame of this Tube-Ice® machine. Consult local codes and regulations regarding seismic and wind load requirements. Additional bracing may be required.

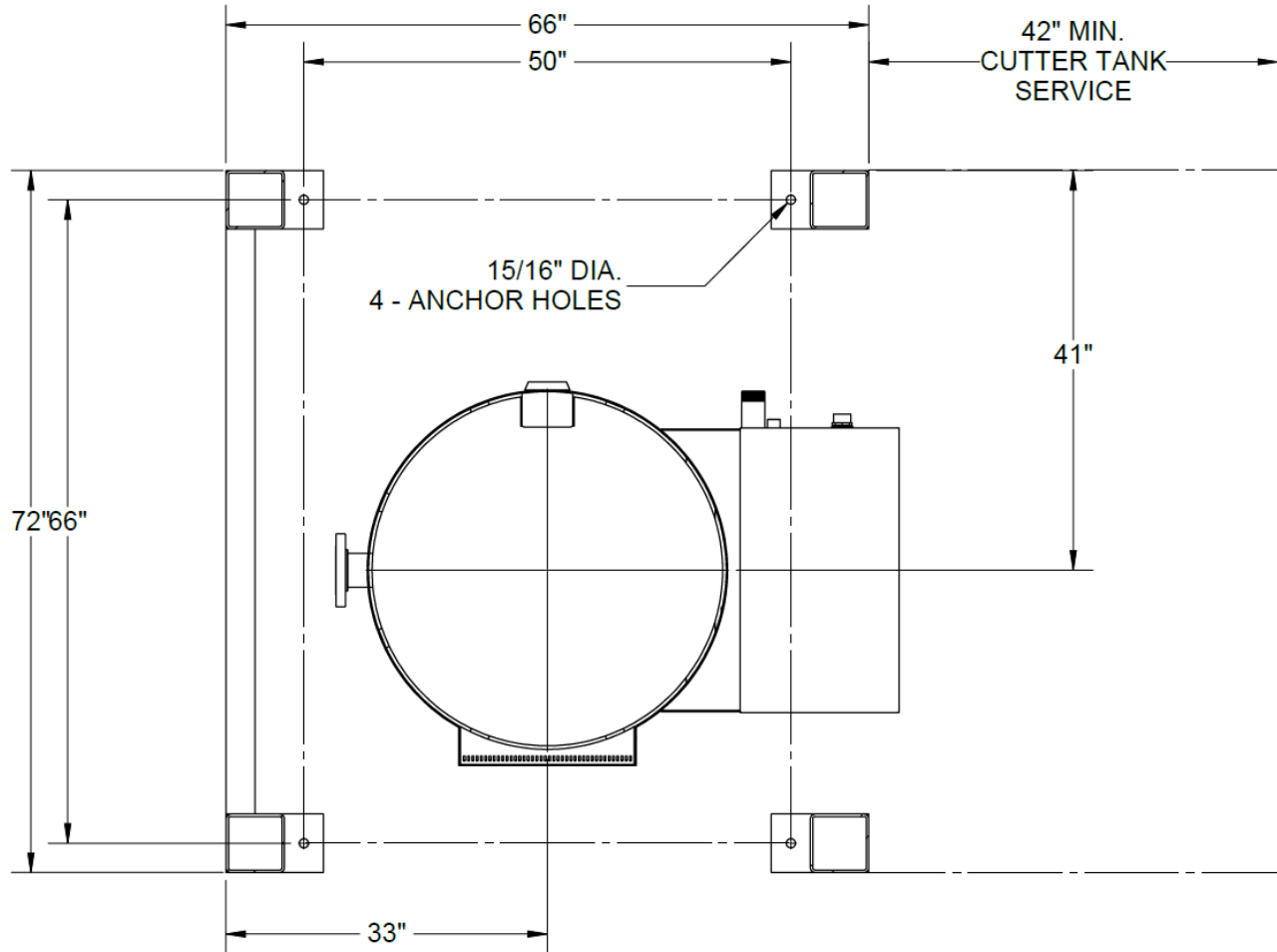

Figure 12: Machine Anchor Points

Piping and Drain Connections

CAUTION

External shut-off valves must be installed in the water inlet lines. The minimum inlet water pressure for satisfactory operation of the machine is 30 psig (2 bar). The maximum allowable pressure is 90 psig (6.2 bar).

Figure 5 to Figure 7 show locations for all connections. Table 2 shows drain sizes.

Table 2: Water Supply and Drain Sizes

Makeup Water In	Water Tank Drain	Blowdown Water Out
1-1/2 in. (DN 40) FPT	2 in. (DN 50) FPT	3 in. (DN 80) FPT

The blowdown outlet and water tank drain connections must be extended to an open drain or sump, arranged for visible discharge. Do not allow water to be trapped in the water tank drain line, because this will interfere with the operation of the automatic blowdown system.

Cooling Tower (Optional)

When selecting a cooling tower, pay careful attention to operating wet bulb conditions. Check with your local cooling tower distributor for their recommendations based on actual operating conditions in your area. An average wet bulb temperature of 78°F (25°C) is typical in the United States, but many localities have design wet bulb temperatures as low as 72°F (22°C) or as high as 82°F (28°C). All standard Vogt-supplied cooling towers are sized for 78°F (25°C).

The cooling tower water pump must be capable of delivering the required volume of water through the condenser. The pump must be sized for each installation, which depends on cooling tower location, pressure drop through water lines, and water regulating valves. The water piping for the cooling tower and the installation of the pump must be in accordance with the manufacturer's instructions.

Proper water treatment for the prevention of mineral and foreign matter accumulation in the condenser or cooling tower is recommended. A water analysis by an independent laboratory should be completed to determine the proper chemicals to use.

Pressure Relief Valves

Pressure relief valves are included with this Tube-Ice® machine. Two are located on the freezer (low-side). These valves are designed to vent in emergency conditions. This ensures that the vessel internal pressure does not exceed the maximum allowable pressures as stated on the vessel nameplates.

Vent each of the pressure relief valves to a safe outdoor location away from people and building openings in accordance with local and national codes.



Warning: Pressure relief valves must be replaced after five years of service. Before replacing relief valves, review requirements per current local and national codes. Valve replacement should be performed only by service personnel experienced and certified in refrigeration and qualified to work with high-voltage electrical equipment. If a relief valve discharges, the valve must be replaced before putting the machine back into service.

Relief valves do not properly reseal after a discharge event. Contact Vogt SuperCare Customer Service at 1-502-635-3000 or 1-800-853-8648 for replacement valves.

Wiring and Electrical Connections



Warning: Only service personnel experienced and certified in refrigeration and qualified to work with high-voltage electrical equipment are allowed to install or work on this Tube-Ice® machine.

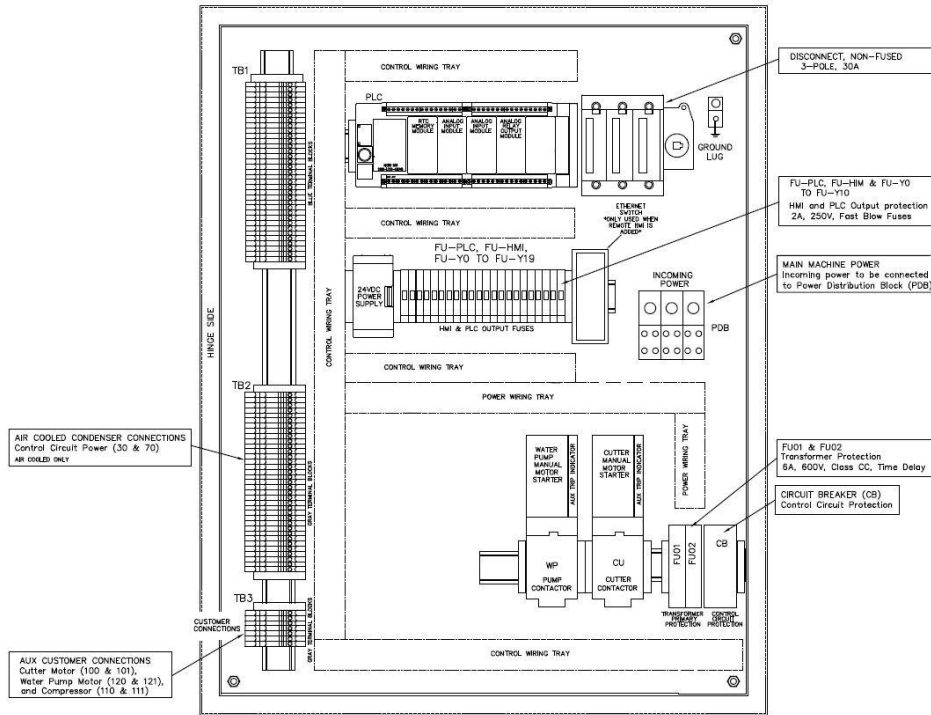

Figure 13: Control Panel Power Connections (60 Hz)

Table 3 shows how to properly size wiring connections. A fused disconnect must be provided near the Tube-Ice® machine. Connect three-phase power to Terminals L1, L2, and L3 on the power distribution block (PDB) for operation of the Tube-Ice® machine and its controls. Rotation checking of cutter motor and water pump is required. Also, if one leg of the three-phase power is higher or lower, then it should be connected to Terminal L2. Connect the ground wire to the provided ground lug (not shown).

Table 3: Electrical Specifications

Standard Voltages	Low Side Only, Water-Cooled			*Optional Remote High Side, Water Cooled		
	Full Load Amperage	Min. Ampacity	Max. Fuse	Full Load Amperage	Min. Ampacity	Max. Fuse
460V, 3ph, 60 Hz	13.3	16	30	333.3	413	735

* **Note:** Values include lowside unit

Phase Check

CAUTION

Do not attempt to start the machine without priming the water pump and insuring proper rotation of both the cutter motor and pump motor.

Cutter and pump motor rotation are synchronized at the factory but must be checked at installation. For ice production, the cutter disc, as viewed at the ice discharge opening, should turn from left to right. The pump rotation should match the marking on the pump housing. The pump must be primed by starting the machine in Clean mode and allowing it to run for several minutes. To change the direction of rotation for the motors, disconnect the power and reverse L1 and L3 (incoming power wires) at the motor contactor in the control panel.

Voltage Imbalance

Voltage imbalance can cause motors to overheat and fail. Voltage imbalance between any two legs should be no greater than 2%.

Example: Supply voltage = 230V – 3-Phase – 60 Hz

Voltage Readings:

A-B = 220 Volts	}	Average = 224 Volts
B-C = 225 Volts		
A-C = 227 Volts		

(A-B) $224 - 220 = 4$ Volts (Highest Deviation)

(B-C) $225 - 224 = 1$ Volt

(A-C) $227 - 224 = 3$ Volts

% Voltage Imbalance = $100 \times (4/224) = 1.78\%$ "Acceptable"

CAUTION

Contact your local electric utility company if the supply voltage phase imbalance is >2%.

Current Imbalance

Voltage imbalance causes a current imbalance, but a current imbalance does not necessarily mean that a voltage imbalance exists. A loose terminal connection or a buildup of dirt or carbon on one set of contacts would cause a higher resistance on that leg than on the other two legs. Current follows the path of least resistance; therefore, if Terminal L1 is loose or dirty, L2 and/or L3 will have higher current.

Higher current causes more heat to be generated in the motor windings. The maximum acceptable current imbalance is 10%.

Example:

Current Readings:

L1 = 96 Amps	}	Average = 95 Amps
L2 = 91 Amps		
L3 = 98 Amps		

(L1) $96 - 95 = 1$ Amp

(L2) $95 - 91 = 4$ Amps (Highest Deviation)

(L3) $98 - 95 = 3$ Amps

% Current Imbalance = $100 \times (4/95) = 4.2\%$ "Acceptable"

Ice Bin Thermostat Sensor

An electronic thermostat, a standard feature on every HFO machine, automates the machine's various cycles.

To ensure proper protection for the machine or auxiliary equipment, the thermostat's sensor must be positioned so that the ice will contact it when the bin is full. The distance between the top of the ice bin and the sensor must allow space for the machine to make an additional discharge of ice after the ice contacts the sensor.

Note: The sensor should also be mounted on the back side of the bracket, opposite of the front of the bin to reduce the possibility of damage from ice removal equipment.

The control panel is electrically connected so that the ice bin thermostat will stop the machine only upon the completion of a harvest period (freezer is empty of any ice).

Note: Actual location of the sensor will vary based on bin layout and ice distribution system.

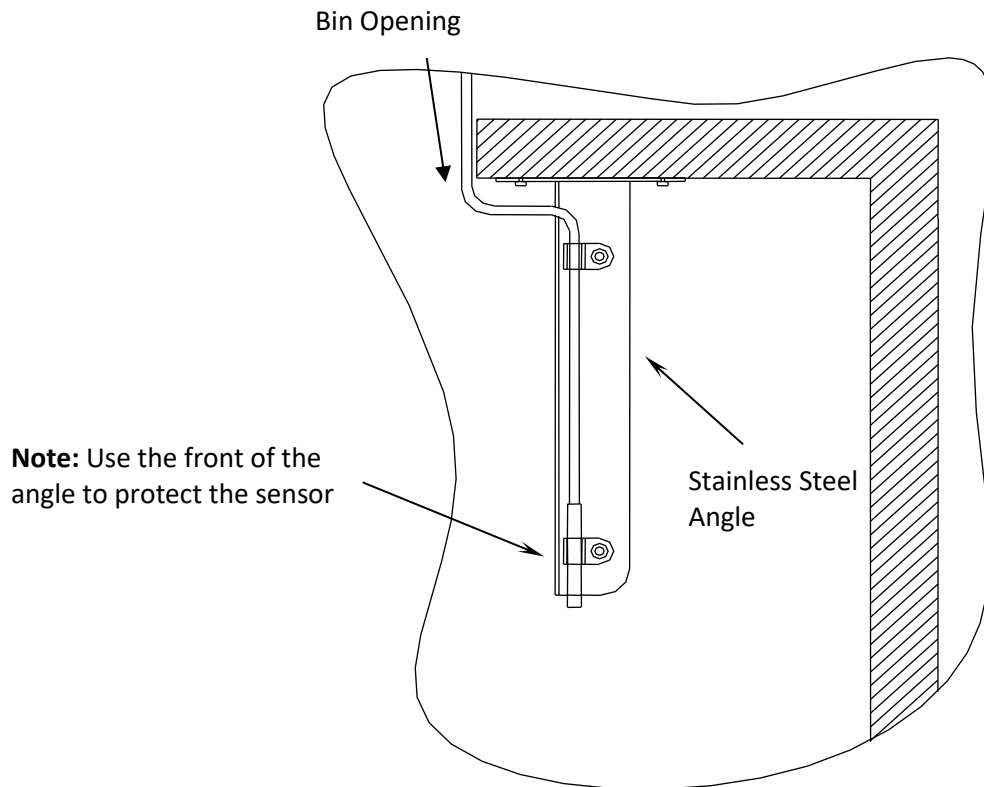

Figure 14: Typical Bin Sensor Mounting Bracket

Installation Checklist

Complete a visual check of the following before continuing or opening any valves:

- Check all joints for leaks that may have developed during shipment.
Note: The machine was shipped with a small positive pressure of 25 psig (1.7 bar). Verify with the freezer pressure gauge.
- All refrigerant piping, water supply, and drain connections properly conform to the requirements in this manual and are properly connected to inlets and outlets.
- The electrical supply is properly sized for fuses and for compliance to local and national codes. Refer to the machine nameplate for minimum circuit ampacity and maximum fuse size.
- All field-installed equipment (augers, conveyors, cooling towers, bin level controls, etc.) is properly installed.
- The applicable portion of the **Warranty Registration/Start-Up Form** has been completed and sent back to Vogt Ice.
- Check the oil level of the cutter gear reducer.
- The water distributors at the top of the freezer should be in position and fit snugly against the tubesheet face.

CAUTION

The compressor crankcase heater should be energized for a minimum of two hours, and the oil temperature should be 100°F–110°F (38°C–43°C) before attempting to start the compressor (by others).

Chapter 5 Start-Up, Shutdown, and Operation

Start-Up Checklist



Warning: Only service personnel experienced and certified in refrigeration and qualified to work with high-voltage electrical equipment should be allowed to install or work on this Tube-Ice® machine.

Make sure all of the following items have been checked before starting the machine for the first time:

- Check that the water inlet connections are attached properly. The water inlet shutoff valves for the water tank should be open. The water level in the water tank should be at a height where the makeup water float valve will be closed when the machine is idle, and water should not run out of the overflow.
- Fill the cooling tower sump (by others) and check the tower manufacturer installation and operation instructions prior to operation.
- Make sure the cutter motor gear reducer is lubricated.
- Check that the compressor crankcase oil level is at the proper height as indicated by the compressor body sight glass.
- Open all necessary valves, including:
 - Compressor service valves
 - Thawing gas-line stop valve
 - King valve
 - Both float switch stop valves
- Except the charging valves, check that all stop valves in the refrigerant system are open, according to the attached tags. All valves are tagged with instructions.
- Immediately after opening the refrigerant valves, check the entire machine for refrigerant leaks with an electronic leak detector or by doing a bubble test.
- Check that all water supply lines are open to the water tank and all water tank drain valves are closed.
- Close the exterior disconnect switch to energize the crankcase heater, and check supply voltage against that on motor nameplate for compliance before switching on disconnect.

Note: The AutoStart Delay will begin a 2-hour countdown before allowing the machine to start to ensure that the oil in the compressor is warm enough to operate the machine. The operator can bypass the AutoStart Delay if needed.

Start-Up Procedure (Initial Start-Up)

Note: The machine will start in harvest mode when set to **Ice**. If the pump is already primed, skip to Step 4.

To perform the start-up of the machine, follow the steps below:

1. Press the **Run Water Pump** touch screen button on the HMI to start the water pump.
2. The pump can be stopped and started by pushing **Run Water Pump** touch screen button. The water should be circulated for a minimum of 5 minutes to prime the pump, purge the tubing of air, and lubricate the cutter bearing. By default, the pump will run for 10 minutes and shut off.
3. When there is good water flow, press the **Ice** touch screen button. The screen will change and show the **Start** touch screen button. Pressing the **Start** touch screen button will start the machine in a harvest (thaw) period with the compressor running.
4. At the termination of the harvest (thaw) period, the machine will begin the freeze period.
5. Be sure to observe a minimum of 4 cycles of ice production to confirm the satisfactory operation of the machine (approximate time for 4 cycles is about 200 minutes).
6. Complete the remaining part of the **Warranty Registration/Start-Up Report** upon initial machine start-up and return it to Vogt Ice, LLC.

Shutdown Procedure

CAUTION

The red **E-Stop** button should only be used for emergency shutdown.

For normal shutdown, use the **Off** touch screen button on the HMI and follow the steps below:

1. Press the **Off** touch screen button. Do not use the machine disconnect or the red **E-Stop** to stop the machine. If the disconnect is used, the crankcase heater is de-energized, and liquid refrigerant migrates to the compressor.
2. During a freeze period, the machine will continue to run.
3. At the completion of the freeze period, the machine will harvest and stop. The completion of a cycle (1 freeze plus 1 harvest) ensures that all ice is removed from the freezer to prevent refreeze when the machine is restarted. Before turning off, the machine will perform a partial pumpdown.
4. During a harvest period, the machine will complete the harvest, perform a partial pumpdown, and stop.

Start-Up and Shutdown Tips

- If the operation of your machine is not controlled by a timer, bin level control, or some other mechanism to automatically start and stop ice production, you should use only the touch screen HMI to start and stop the machine.
- By pressing the **Off** touch screen button, the machine will stop after the next harvest period. It will perform a partial pumpdown before turning off.
- Do not use the **E-Stop** button or the machine disconnect for normal shutdown of the machine.
- Disconnect the machine only in an emergency or for safety when performing certain service or repairs to the machine. The compressor crankcase heater is de-energized when the machine is shut down.
- The **Manual Harvest** touch screen button can be used to initiate a harvest period. When it is pushed during a freeze period, it will immediately initiate a harvest period.

Ice Quality

Your P34HL needs to be set up to produce the desired Tube-Ice[®] hole size. The ice produced in the freezer should have a small hole in the middle of each tube to avoid permanently damaging the freezer. Table 4 shows recommended hole sizes for determining ice quality. For further information, refer to Chapter 9.

Table 4: Average Hole Size in Tube-Ice[®]

Tube Size in. (mm)	1 (25)	1-1/4 (32)	1-1/2 (38)
Hole Size in. (mm)	1/16–1/8 (1.6–3.2)	1/8–3/16 (3.2–4.8)	1/4–3/8 (6.4–9.5)

Adding Refrigerant

CAUTION

Be sure to follow all local and federal regulations regarding the handling of refrigerants and their illegal emission into the atmosphere.

Add refrigerant while the machine is running according to the steps below:

1. With a cylinder of refrigerant laying on it's side, the cylinder valve outlet pointing upward and the bottom end raised slightly above the valve end, connect a hose approved for use with R-513A between the freezer charging valve and the cylinder valve.
2. Purge all air from the charging hose and open the cylinder valve gradually to check for possible leaks around the packing nut or hose fittings. Fix leaks before continuing.
3. Open the cylinder valve fully.
4. With the refrigerant feed light off, open the freezer charging valve to allow refrigerant to flow from the cylinder to the freezer.
5. When the refrigerant feed light turns on, immediately close the cylinder valve. Repeat until properly charged.

For the optionally available HFOPAK50, the receiver can be charged directly until the level reaches the center of the highest sight glass on the level column. This indicates the maximum charge level that the HFOPAK50 can safely contain.

If adding refrigerant after a leak has been repaired, add new refrigerant into the P34HL according to the steps above. Check the refrigerant level after the machine has operated for a few cycles. Refrigerant should always be visible in the middle sight glass on the HFOPAK50 receiver level column at the end of the freezing period.

If the level is low at this time, enough refrigerant should be added to the system to raise the level above this point.

Note: Refrigerant can only be added during the freeze period.

Add no more than 10 lb. (4.5 kg) of refrigerant and allow the machine to operate for several cycles before checking the level again.

It is also possible to check the refrigerant level by pumping down the machine (Refer to *Pumpdown*). When the machine is pumped down, some liquid should be observed in the receiver's sight glass.

Refrigerant must be added in liquid form through the machine's charging valve. No air or other non-condensable gases should enter the system when filling the machine with refrigerant. The compressor crankcase heater must be energized for a minimum of two hours before starting and running the compressor.

While the machine is running, add refrigerant according to the steps below:

1. Connect the charging valve on the machine to the refrigerant cylinder using a hose or pipe suitable for R-513A service. Refer to the instruction card attached to the refrigerant cylinder.
2. Open the valve on the refrigerant cylinder and purge air out of the charging line at the charging valve connection.
3. Open the charging valve on the machine.
4. The charging valve must be closed when the freezer is in a harvest period.

DANGER

Immediately close the machine charging valve at the start of the harvest period if a refrigerant cylinder is connected. Never leave a refrigerant cylinder connected to the system except during charging operations. Failure to observe either of these precautions can result in transferring refrigerant from the system into the refrigerant cylinder, causing it to overfill and possibly rupture as the liquid refrigerant expands.

Chapter 6 Electrical Controls and Their Functions

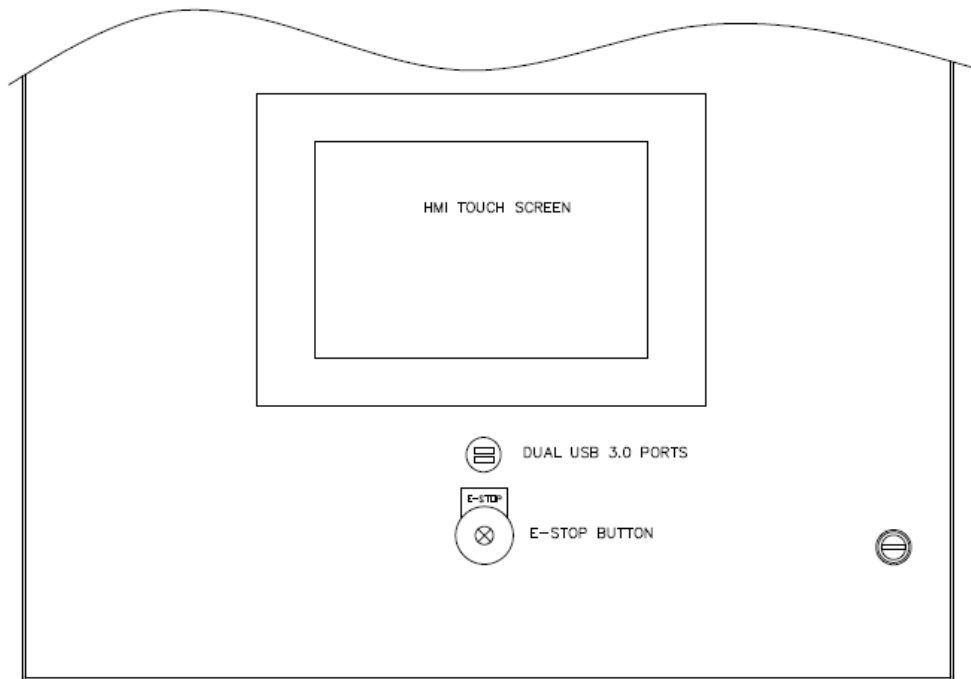

Figure 15: Control Panel (Exterior View)

This machine includes an Allen Bradley PLC with touch screen HMI. All machine control functions like the freezer pressure switch (FPS), the low-pressure safety, the high-pressure safety, the defrost pressure switch (DPS), and the condenser pressure switch (CPS), among others, are handled through pressure transducers and the touch screen.

Note: If damaged, the bin sensor can be replaced without replacing the entire unit. The sensor cable can be extended up to 500 feet (150 m) if using a 16 American wire gauge (AWG) wire. For more information, contact Vogt SuperCare Customer Service.

CAUTION

To provide proper protection for the Tube-Ice® machine and its component parts, be sure to follow the wiring schematic and electrical specification table when incorporating overloads.

CAUTION

The crankcase heater should be energized for a minimum of 2 hours. The crankcase must be free of liquid before attempting to operate the compressor.

The following diagrams show the electrical details for the panel layouts, control circuit, and 3-phase power.

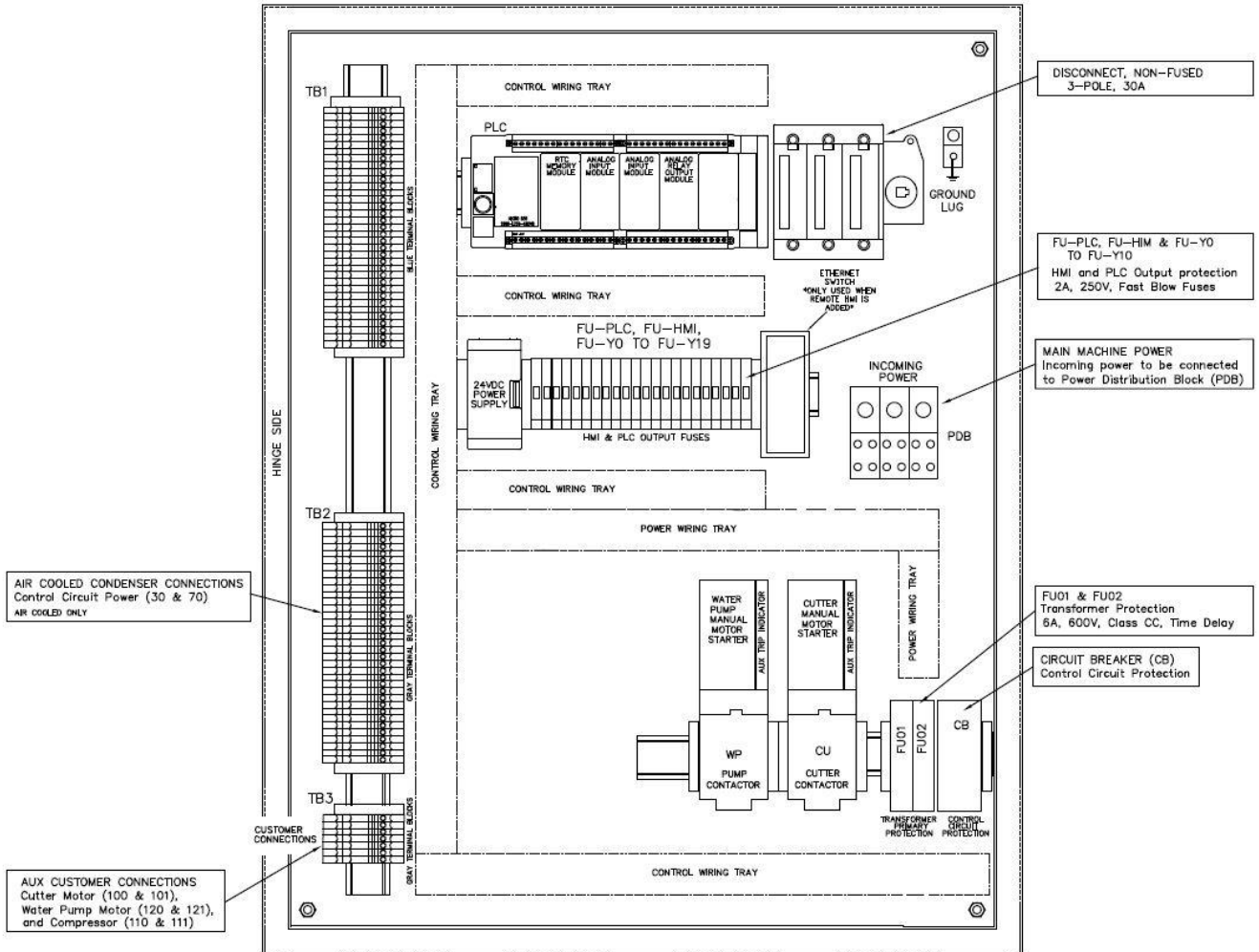

Figure 16: Panel Layout, 60-Hz Non-CE Machines

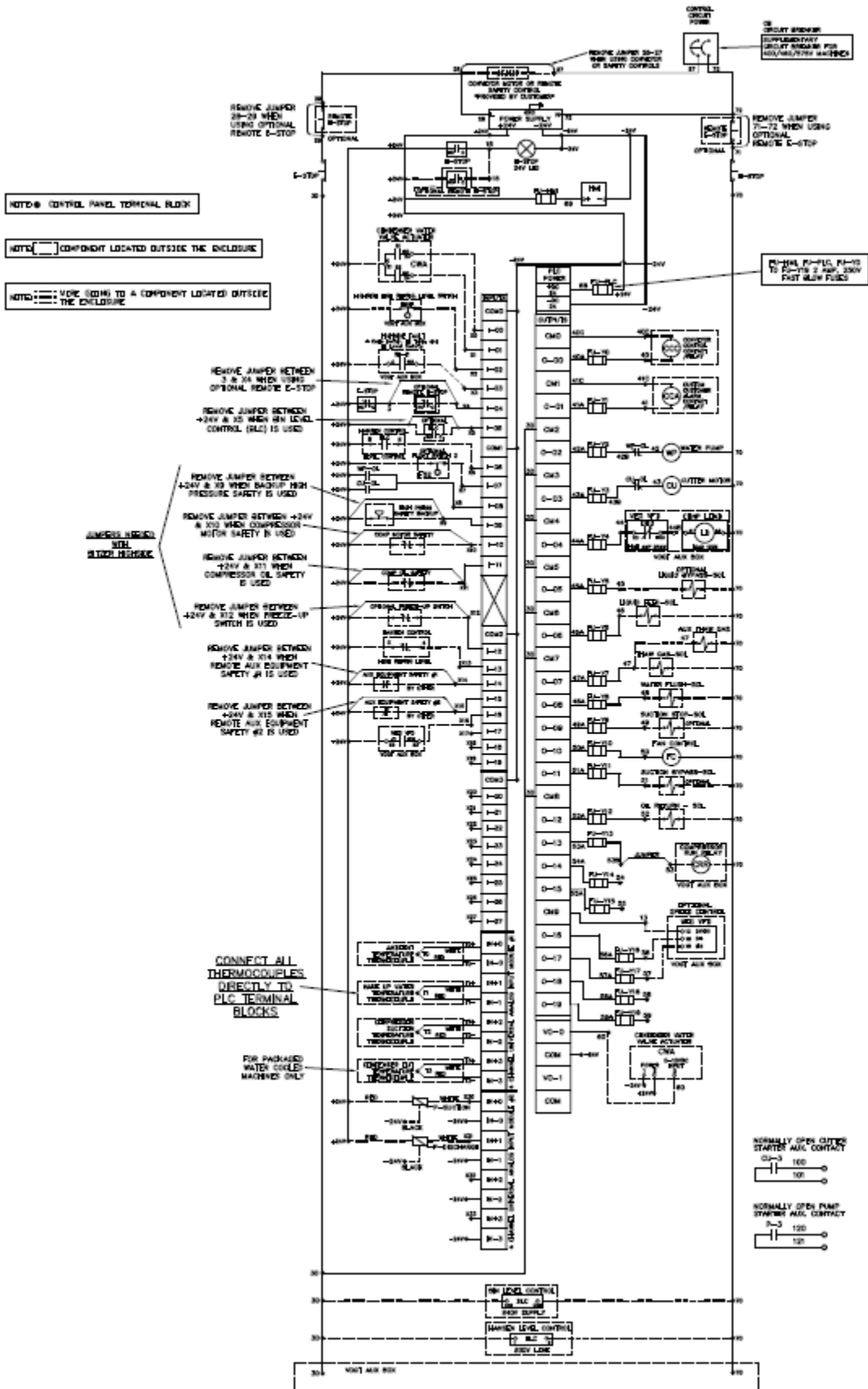

Figure 17: Electrical Schematic, Control Circuit, All Voltages, 60 Hz

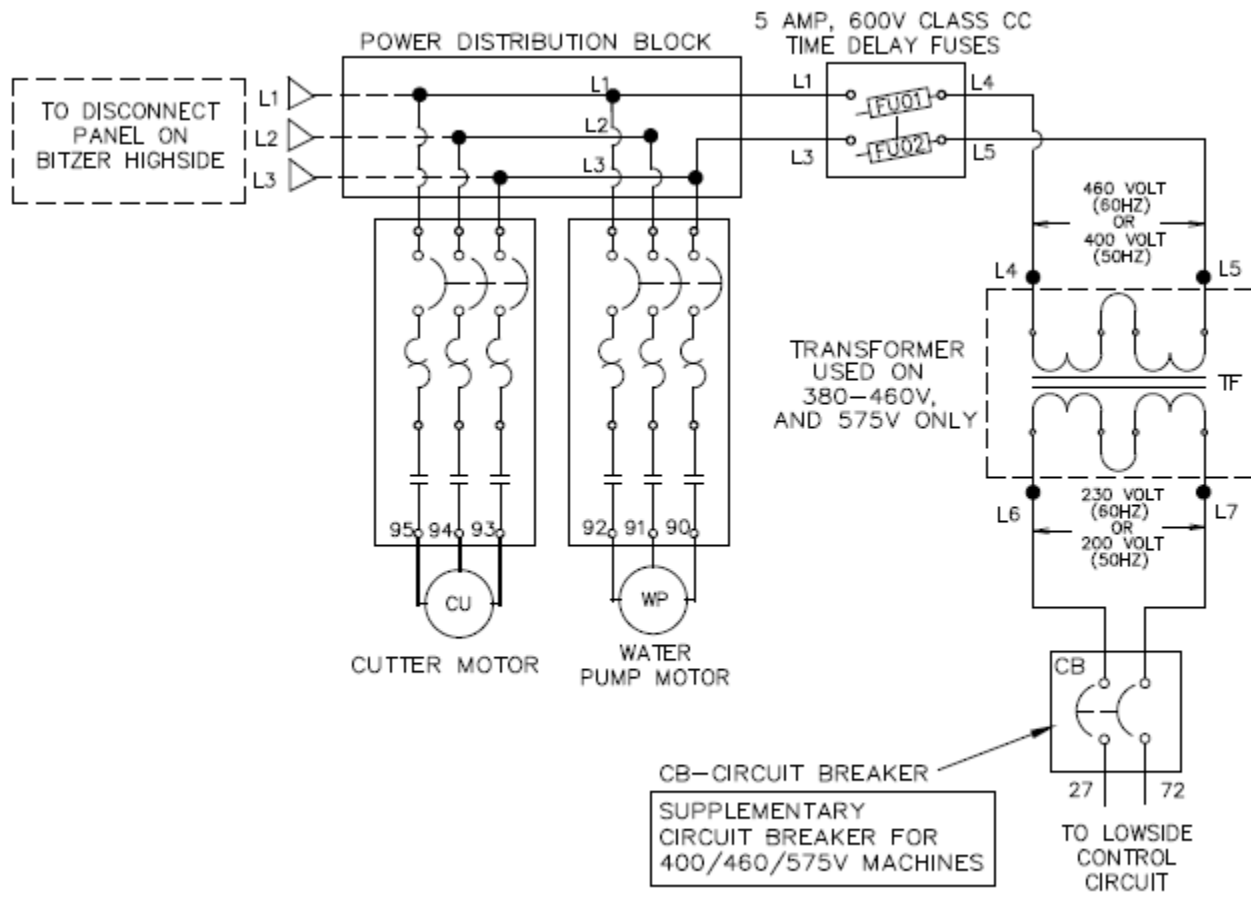

Figure 18: Electrical Schematic, 3-Phase Power, All Voltages 60 Hz

Table 5: Control Panel Parts

Label	Item	Vogt Part No.	Description
CB	Control Circuit Breaker	12A7515E22	Circuit Breaker, Supplementary, 6A, 2 Pole
CU	Cutter Motor Starter	12A7516E23	Contactora, 9A, 3 Pole, 1N.O. Aux, 208/240V
		12A7530E52UL	Manual Motor Starter, 0.63-1.0A
		12A7518E33UL	Aux. Trip Contactora, 6A, 1N.O., 1N.C.
E-Stop	Emergency Stop Button	12A7500E159	Illuminated Red, Push-Twist, E-Stop Button
		12A7500E160	Integrated White LED, w/Metal Latch, 24V AC/DC
		12A7500E161	Contact Block, 2N.C.
		12A7500E162	Contact Block, 1N.O., 1N.C.
FU01, FU02	Transformer Primary Fuses	12A7504E13	Fuse, 6A, 600V, Class CC, Time Delay
FU-HMI, FU-PLC, FU-Y0, TO FU-Y19	HMI & PLC Output Fuses	12A7504E23	Fuse, 2A, 250V, Fast Acting
BLC	Bin Level Control	12A2117G09	Ice Bin Level Controller
HMI	PLC Interface	12A7536M72	KEB C6 HMI, 10.1" Wide, Color, Touch Screen
PLC	Processor / Base	12A7536M33	PLC, Micro850, 28 DC Inputs, 20 Relay Outputs, 24VDC
	Real Time Clock/Memory Module	12A7536M75	Plug-In Memory backup & Real Time Clock
	Output Module	12A7536M67	Plug-In Module, Digital 4 Point Relay Output
	Input Module	12A7536M69	Plug-In Module, 4 Channel Universal Analog Input
	Optional Analog Output Module	12A7536M74	Plug-In Module, 2 Channel Analog Output
PS	24VDC Power Supply	12A7537E04	Power Supply, 120/240VAC In, 24VDC/2.5A Out
WP	Water Pump Motor Starter	12A7516E25	Contactora, 16A, 3 Pole, 1N.O. Aux, 208/240V
		12A7530E58UL	Manual Motor Starter, 10.0 - 16.0A
		12A7518E33UL	Aux Trip Contactora, 6A, 1N.O., 1N.C.
Misc Items	Temperature Sensors	12A2117G22	Thermocouple, Type K, Suction Temp (15ft), Water Temp (13ft), Ambient (3ft)
	Pressure Transducer(s)	12A2117J09	Pressure Transducer, 0-500 PSI, 12-33 VDC Excit, 0 to 10VDC Out
	Ethernet Cable	T080300042	Cat 5 Cable, 36", HMI to PLC

Allen Bradley PLC with Touch Screen HMI

The Allen Bradley PLC with Touch Screen HMI is replacing and integrating the former standalone freezer pressure switch (FPS), the bin thermostat, the low-pressure safety, the high-pressure safety, the defrost pressure switch (DPS), and the condenser pressure switch (CPS) with pressure transducers and thermocouples that interact with a touch screen interface. Features such as superheat trends, detailed fault history, and remote access have been added to aid in regular operation, maintenance, and service.

HMI Main Menu

The Touch Screen HMI is the visual representation of the control functions contained within the PLC. When the machine is first started, the user is presented with the **MENU** screen. The **MENU** screen is also accessed by pressing the grid touch screen button  from any screen in the HMI.

The touch screen buttons on the **MENU** screen access different submenus within the system. Refer to Figure 19.

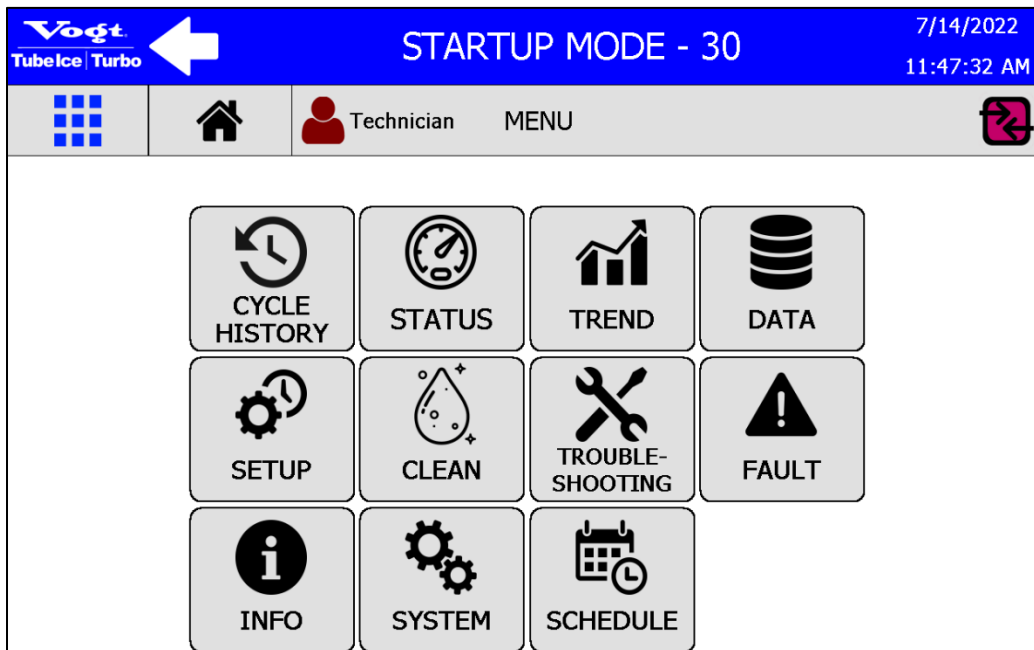

Figure 19: MENU Screen

The **MENU** screen gives access to the submenus below:

- **CYCLE HISTORY** – Displays the Cycle History for the last 50 cycles.
- **STATUS** – Displays the current Suction Pressure, Discharge Pressure, Ambient Temperature, Make-Up Water Temperature, Suction Temperature, and Superheat. Also displays the current setpoints for the **Freezer Pressure Switch** and **High Pressure Safety**, and the status of **PLC Inputs and Outputs**.
- **TREND** – Displays graphs of the Suction Pressure, Discharge Pressure, Ambient Temperature, Make-Up Water Temperature, and Compressor Superheat for the last 8 hours.
- **DATA** – Displays general analytics of the machine. Allows the operator to download or email machine data collected by the HMI and to set up automatic performance reporting.
- **SETUP** – Displays the user adjustable setpoints, delays, and safeties such as **Freezer Pressure Switch**, **High Pressure Safety**, **Cutter Delay**, **Harvest Time**, **Air Cooled Fan Cycling**, etc.
- **CLEAN** – Allows the operator to enter the clean mode on the machine and access the cleaning log.
- **TROUBLESHOOTING** – Allows the operator to perform a full pumpdown for maintenance, check the status of PLC inputs and outputs, and to activate individual PLC outputs to test individual components on the machine (i.e. – water pump, cutter motor, etc). Includes a Log that records maintenance events.
- **FAULT** – Displays historical fault data for the machine and resetting of faults.

- **INFO** – Displays information about the ice machine including Serial Number, Job Number, Manufactured Date, etc. Provides access to digital service manual.
- **SYSTEM** – Allows the operator to activate notifications and remote access capability. Provides access to the setup of machine user groups.
- **SCHEDULE** – Allows the operator to create schedules for automatic operation of the machine for defined times of day or a specified number of ice making cycles.

The top bar of the HMI displays shortcut menus and system status information. Refer to Figure 20.

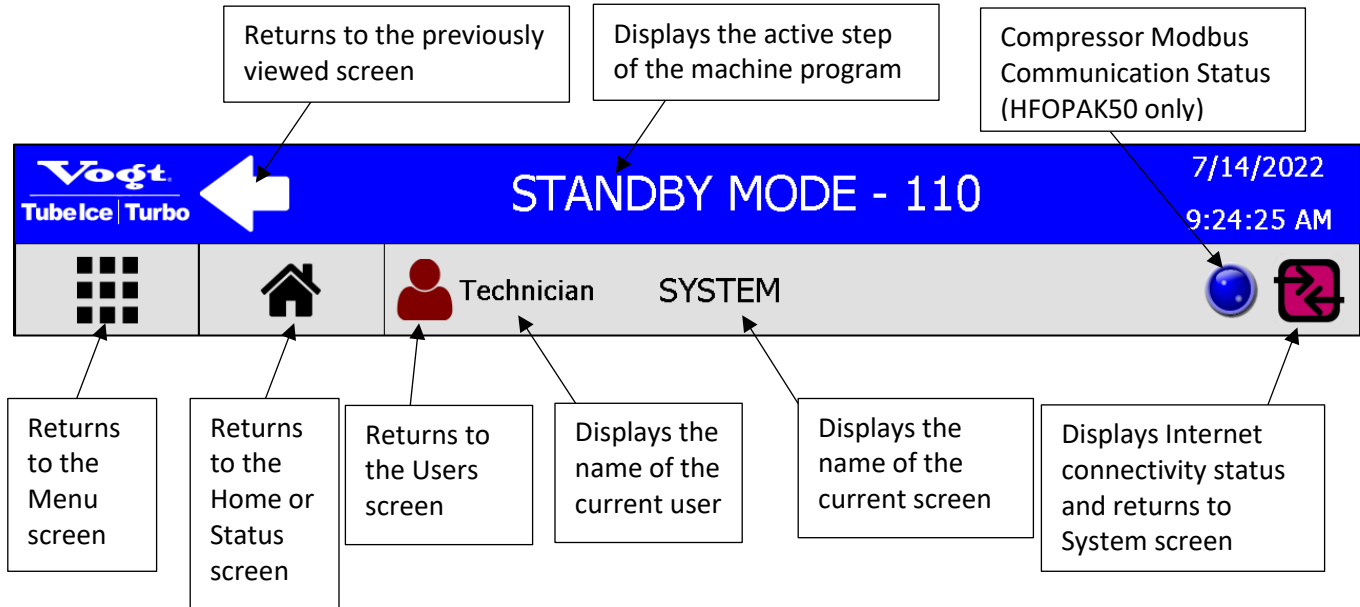









Figure 20: Top Screen Detail

For Internet connectivity status, the system status is according to the color code below:

-  The machine is connected to the Internet and a remote user is logged in.
-  The machine is connected to the Internet, but no remote users are logged in.
-  The machine is connected to the internet and remote access is turned off.
-  The machine is not connected to the Internet.
-  The machine is not connected to the Internet and remote access is turned off.

The Current User icon color is according to this color code:

-  Operator
-  Technician
-  Manager
-  Support
-  Developer

For Optionally Supplied HFOPAK50 Remote High Sides

If the Compressor Modbus Communication Status icon noted above is not blue, then the HMI and the HFOPAK50 are not in communication. The system can operate without Modbus communication, but compressor faults on the HFOPAK50 cannot be identified or reset from the HMI.

HMI Primary Submenus

The HMI contains submenus that provide access to machine functions and reports. The primary submenus are accessed from the **MENU** screen, Figure 19, and are detailed below. Refer to Figure 21 through Figure 30.







Vogt TubeIce Turbo		FREEZE CYCLE - 460				12/3/2020 5:01:47 PM
		 Technician	CYCLE HISTORY			
Cycle History		Page 1/10				 
Cycle Number	Current	2	3	4	5	
Freeze Start Date & Time	16:00:17 12/11/2020	15:38:08 12/11/2020	15:15:43 12/11/2020	14:53:30 12/11/2020	14:32:04 12/11/2020	
Freeze Time	18m32s	19m7s	19m24s	19m12s	18m25s	
Freeze Avg Make Up Water (°F)		56.6	56.5	55.9	54.7	
Freeze End Suction Pressure (PSI)		11.9	11.8	11.9	12.0	
Freeze Avg Discharge Pressure (PSI)	Data Logging in Progress	137.1	137.2	137.3	137.2	
Harvest Time		3m	3m	3m	3m	
Harvest Max Suction Pressure (PSI)		44.7	44.3	45.3	44.9	
Total Cycle Time		22m7s	22m25s	22m12s	21m25s	

Figure 21: CYCLE HISTORY Screen

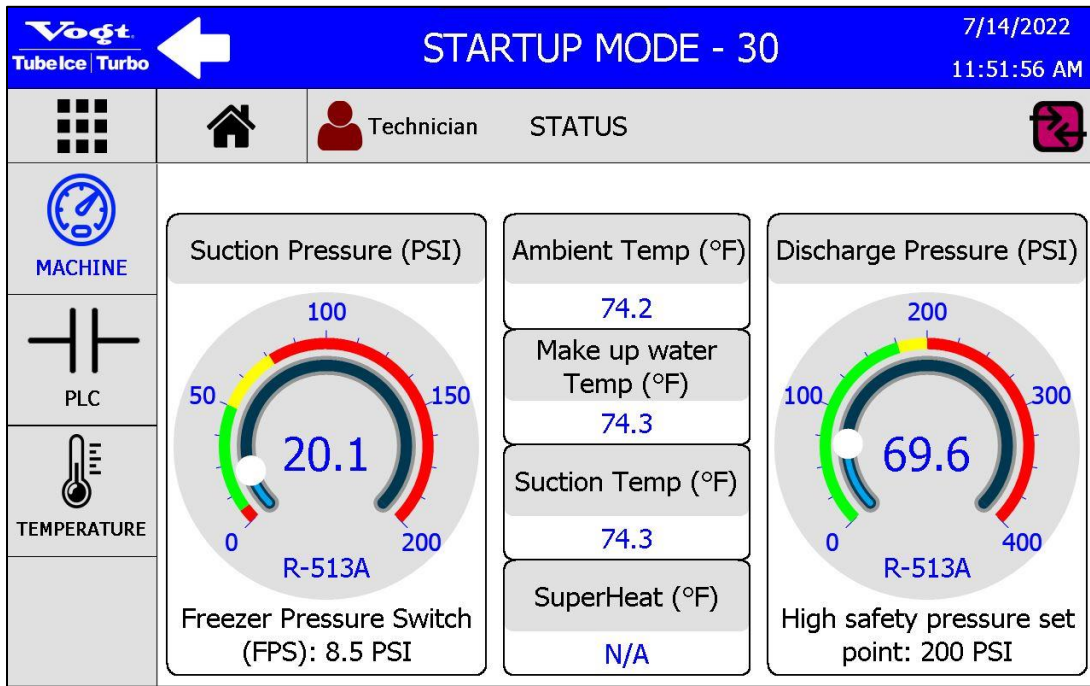

Figure 22: STATUS Screen

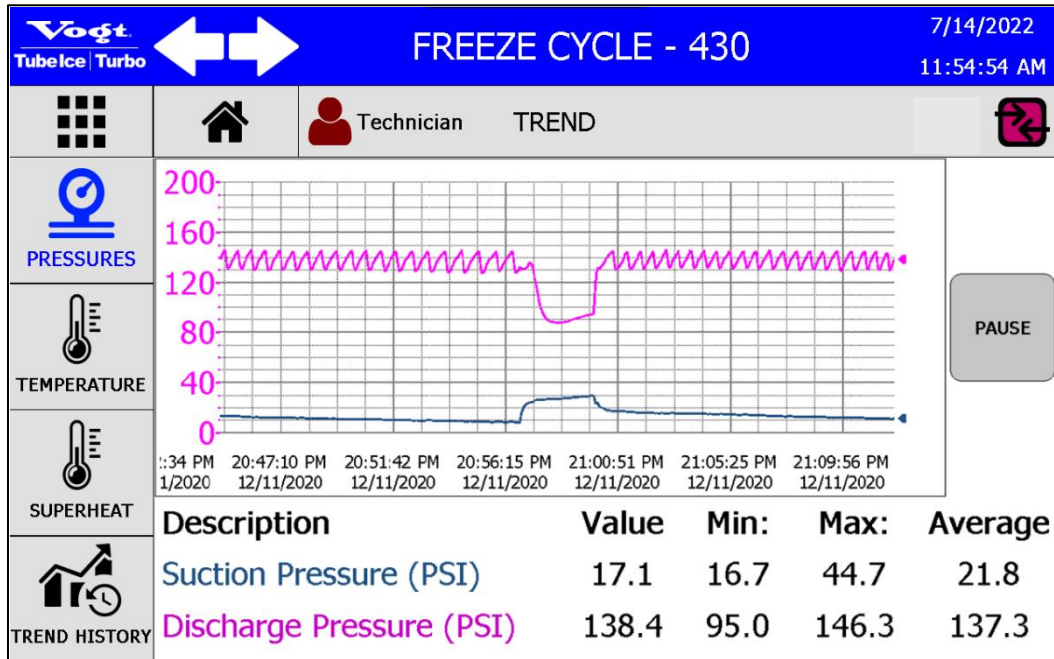

Figure 23: TREND Screen

Voigt Tubelce Turbo		STANDBY MODE - 110				7/14/2022 12:07:49 PM
		Technician	DATA			
SUMMARY		Daily	Week	Month	Year	Total
	Total Cycles	36	212	212	12887	12887
	Avg Cycle Time	5m	5m	5m	5m	5m
	Total Runtime	12h5m	70h41m	70h41m	4295h	4295h
DOWNLOAD	Freeze Avg SuperHeat (°F) @ Compressor	57.9	57.9	57.9	57.9	57.9
	Freeze Avg Discharge Pressure (PSI)	69.6	69.6	69.6	69.6	69.6
EMAIL	Avg Freeze Make Up Water Temp (°F)	76.6	76.6	76.6	76.6	76.6
	Power On Time	12h7m	84h7m	84h7m	4788h	4788h
PERFORMANCE REPORT	Time Since Machine Built					5148h

Figure 24: DATA Screen

Voigt Tubelce Turbo		HARVEST CYCLE - 330		7/14/2022 9:42:49 AM
		Technician	SETUP	
TIMERS	Harvest Timer (sec)	<input type="text" value="240"/>		Page 1/2
	Thaw Gas Valve Delay (sec)	<input type="text" value="0"/>		
PRESSURES	Cutter Delay (sec)	<input type="text" value="20"/>		
	Partial Pumpdown Timer (min)	<input type="text" value="1"/>		
ADVANCED				
SAFETIES				

Figure 25: SETUP Screen

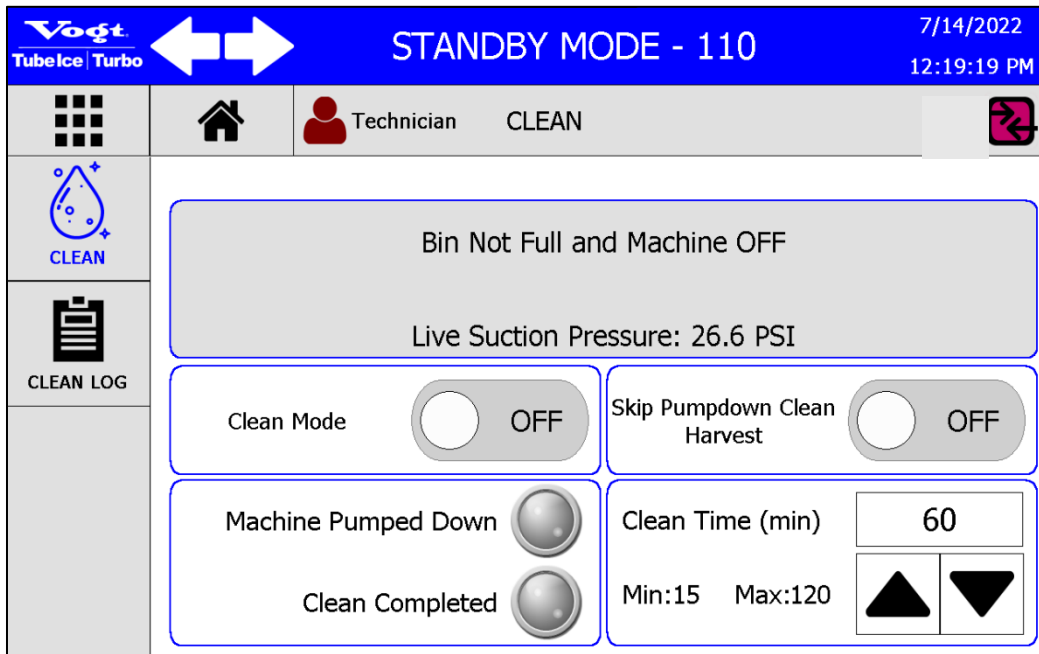

Figure 26: CLEAN Screen

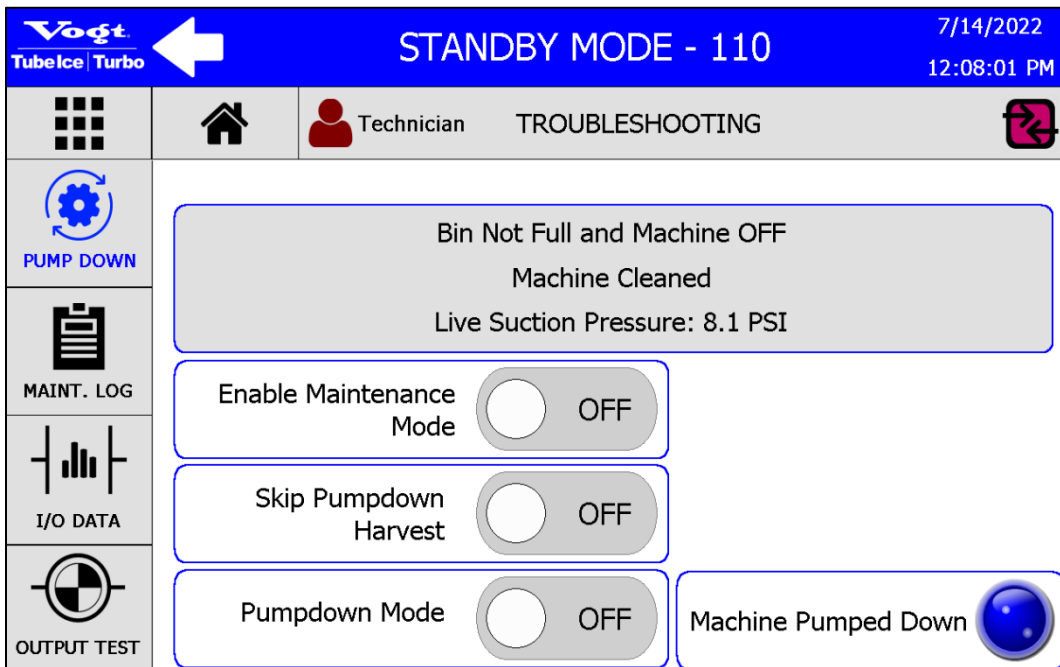

Figure 27: TROUBLESHOOTING Screen

Voegt
Tubelce Turbo

MACHINE FAULT - 9160

8/13/2022
5:52:23 AM

Technician FAULT

Event Time	User	Event	Description
8/13/2022 5:52:01 AM	Technician	FAULT ON	E-Stop Fault During: Standby Mode
8/11/2022 12:13:18 PM	Developer	FAULT RESET	Suction Transducer missing or defective
8/11/2022 12:07:10 PM	View_Only	FAULT ON	Suction Transducer missing or defective During: Startup Mode
7/14/2022 8:45:56 AM	Technician	FAULT RESET	Low Pressure Suction Fault

RESET FAULT Fault Page 1/2

Figure 28: FAULT Screen

Voegt
Tubelce Turbo

MACHINE FAULT - 9140

7/14/2022
12:13:34 PM

Technician INFORMATION

Short Model Number: HFO10

Model Number:

Serial Number:

Job Number:

Refrigerant Type: R-513A

Tube Size: 1 1/4 inch

Condenser Type: Air Cooled

Incoming Power Voltage: 208/230 V./3 P./60 Hz

Manufactured Date: 07/2022

MACHINE

DOCUMENTS

SUPPORT

Page 1/2

Figure 29: INFO Screen

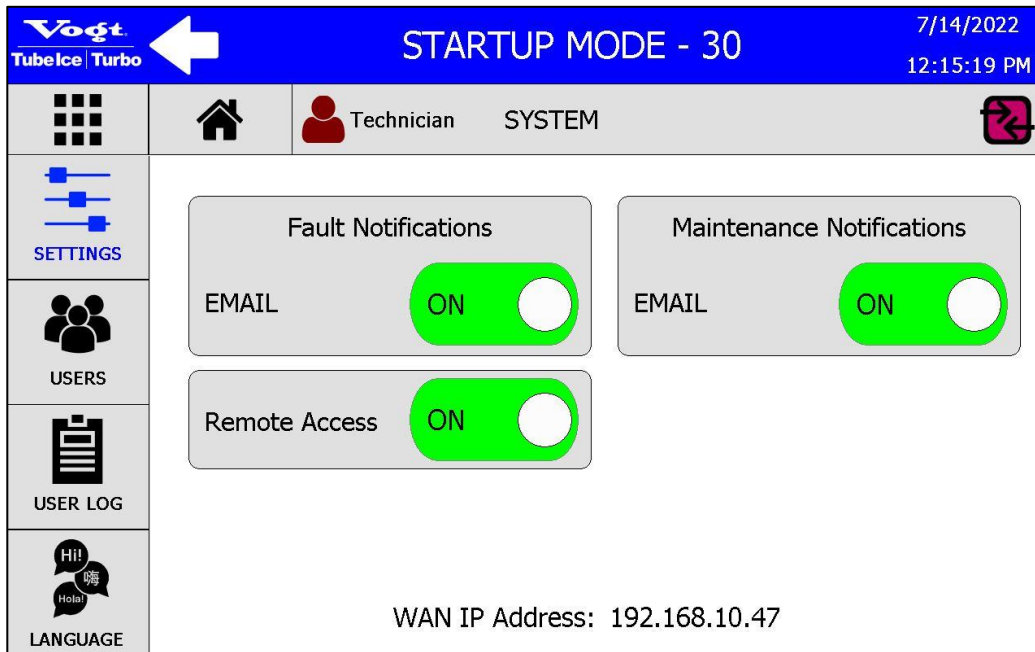



Figure 30: SYSTEM Screen

HMI Home Screen

Pressing the **HOME** touch screen button  from any screen in the HMI will take the operator to the **HOME** screen that displays the primary operational information of the ice machine. Refer to Figure 31.

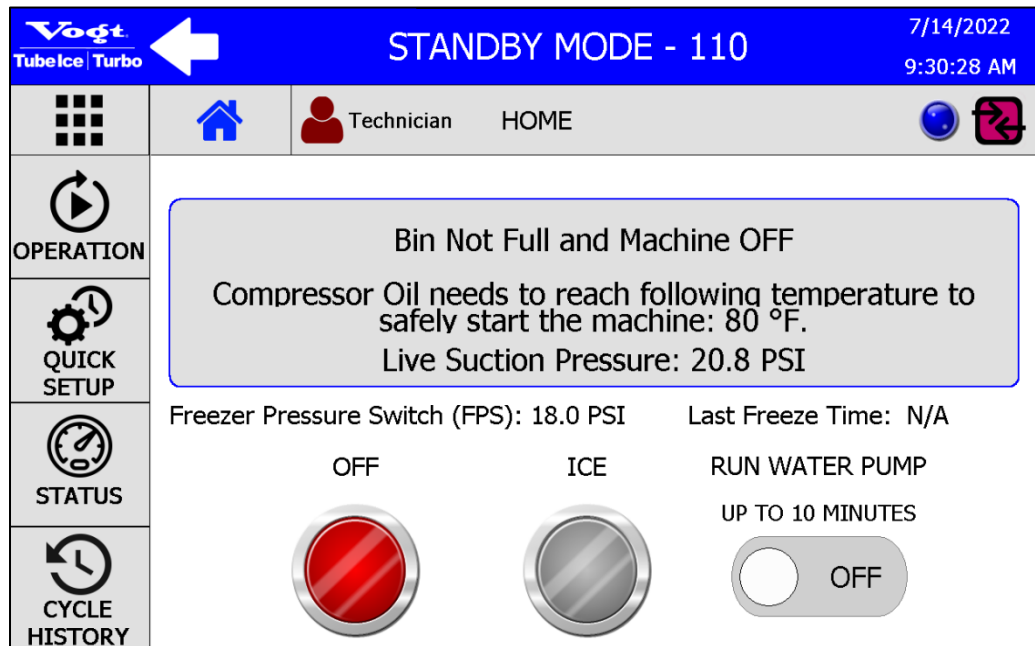

Figure 31: HOME Screen

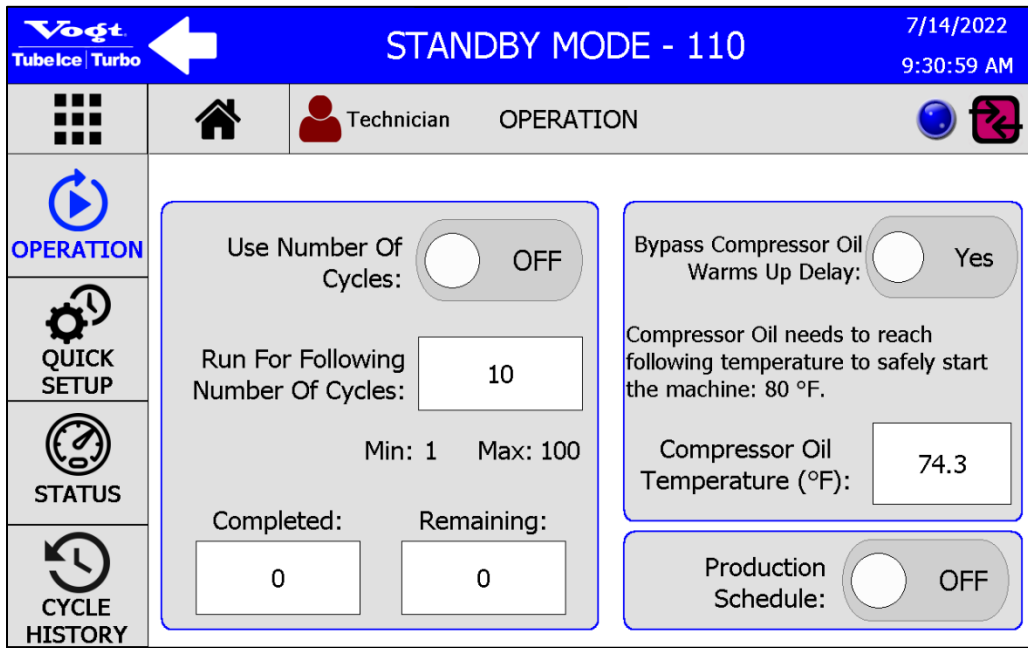

Figure 32: HOME Screen – Operation

Basic machine parameters such as the **Freezer Pressure Switch**, and the **Harvest Timer** can be quickly accessed in the **QUICK SETUP** submenu. See Figure 33.

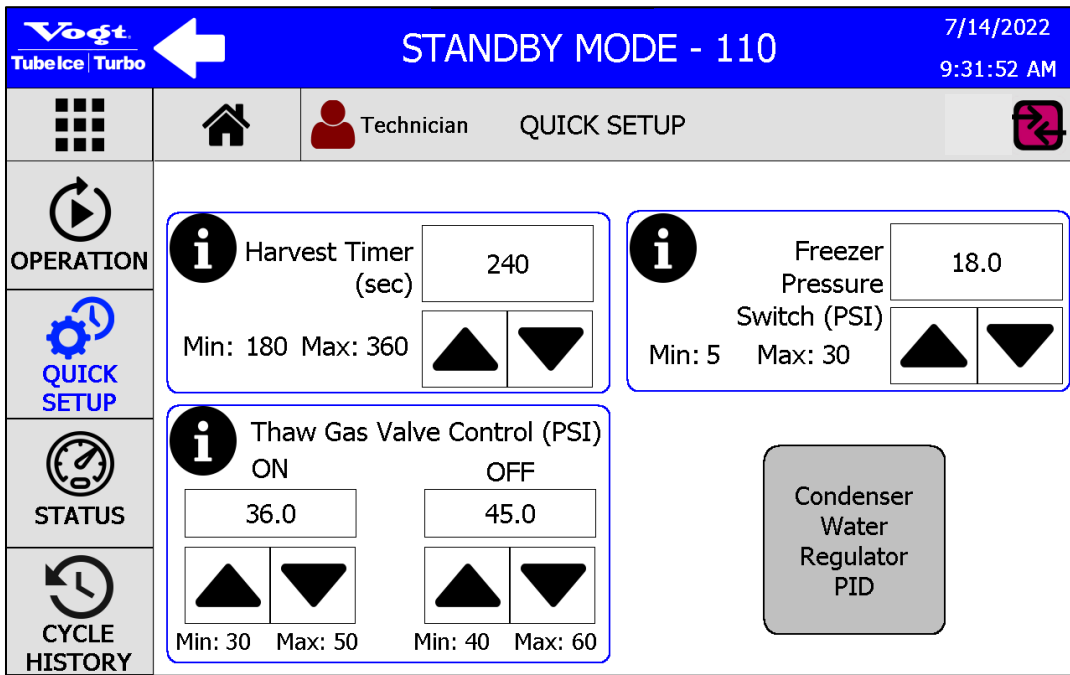

Figure 33: QUICK SETUP

Pressing the information icon **i** provides additional information about each parameter. Figure 34 shows the information available for the **Harvest Timer**.

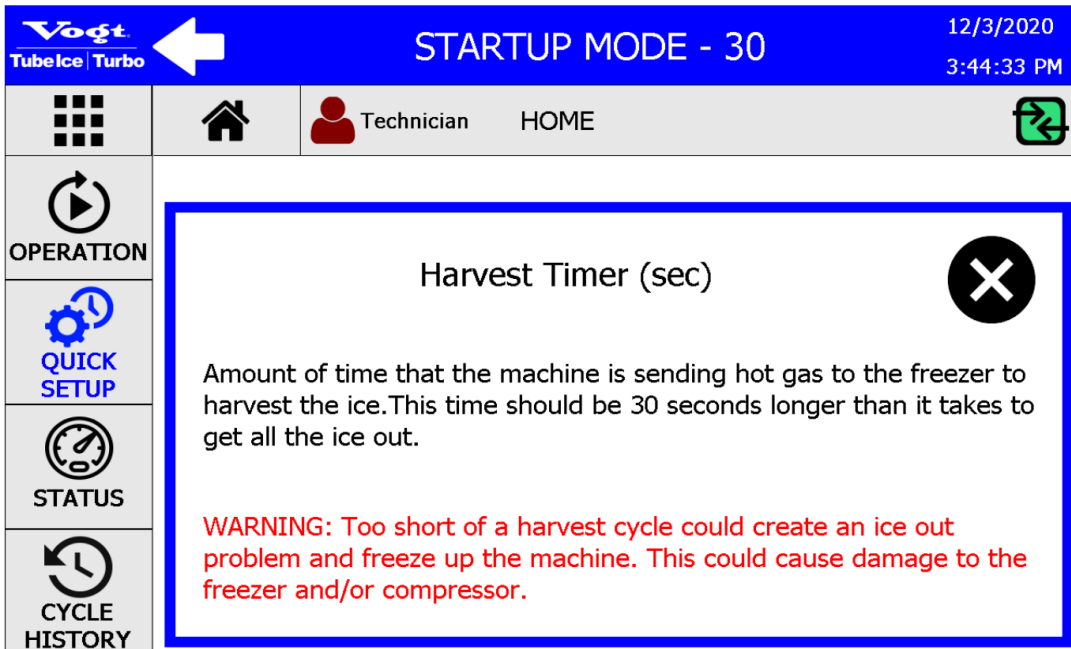

Figure 34: Information Icon Detail

For Optionally Supplied HFOPAK50 Remote High Sides

A 3-way regulating valve is included with water cooled versions of the HFOPAK50 high side. The valve is controlled from the HMI located on the P34HL. The PLC on the ice maker controls the regulating valve through a PID loop that is accessed from the **QUICK SETUP** submenu by pressing the **Condenser Water Regulating Valve PID** touch screen button in Figure 33. Refer to Figure 35 below to change the PID settings for the valve.

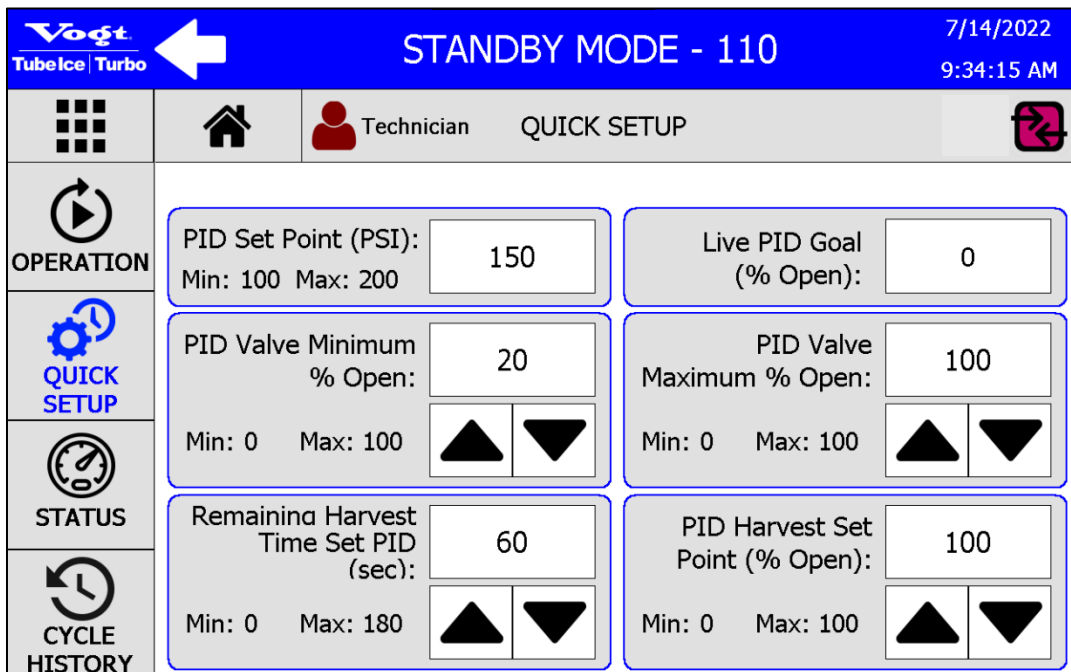

Figure 35: QUICK SETUP – Condenser Water Regulator PID

HMI Detailed Screens

Within each primary submenu that is accessed from the main **MENU** screen, Figure 19, additional menus are available to view specific information about the machine, to access specific functions, or to change specific parameters.

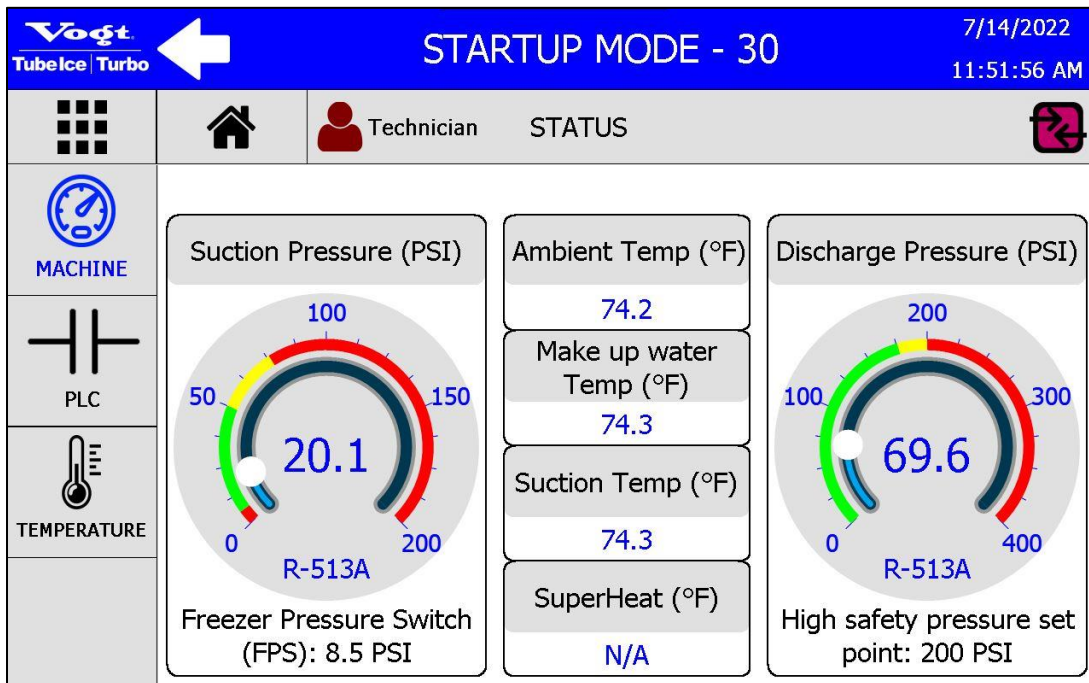

Figure 36: STATUS Screen

The STATUS screen, Figure 36, displays the current Suction Pressure, Discharge Pressure, Ambient Temperature, Make-Up Water Temperature, Suction Temperature, and Superheat. From this screen, PLC input and output status is viewed by pressing the **PLC** submenu touch screen button. See Figure 37.

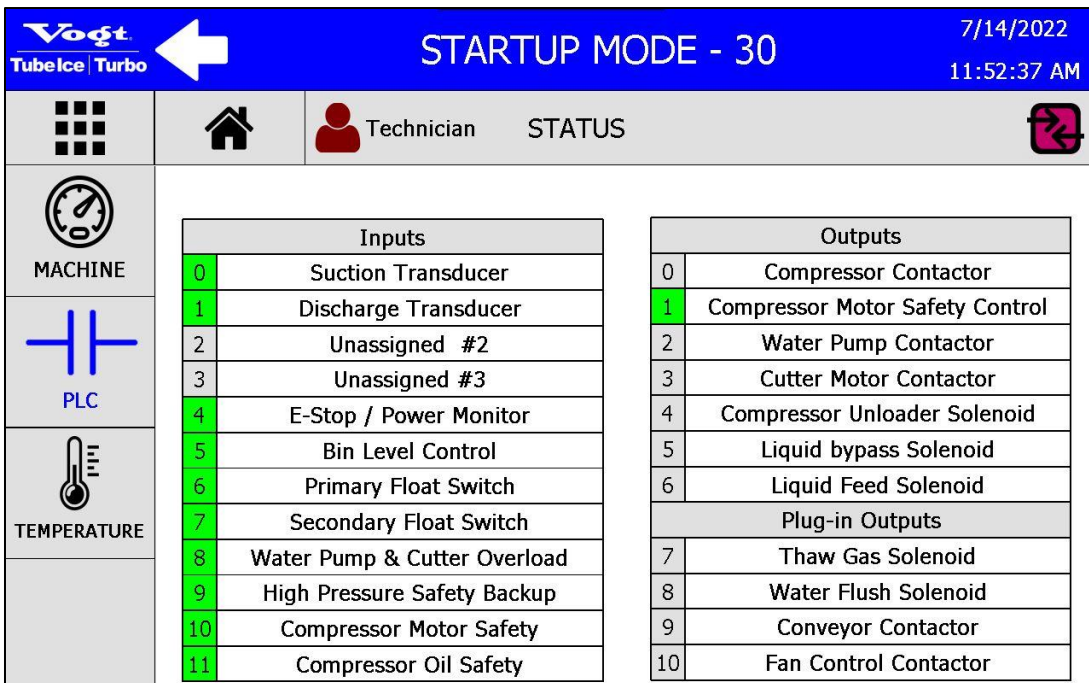

Figure 37: PLC Submenu

The **TREND** screen, Figure 23, displays Pressure, Temperature, and Superheat graphs by pressing the touch screen buttons. Press the **TEMPERATURE** and **SUPERHEAT** touch screen buttons to view graphs of each. **TREND HISTORY** is available for up to 8 hours by pressing the **PAUSE**, **SCROLL BACK**, and **SCROLL FORWARD** touch screen button for the graph. See Figure 38 through Figure 40. The **SUPERHEAT** trend will only show data if the ice machine is connected to the optionally available HFOPAK50 remote high side.

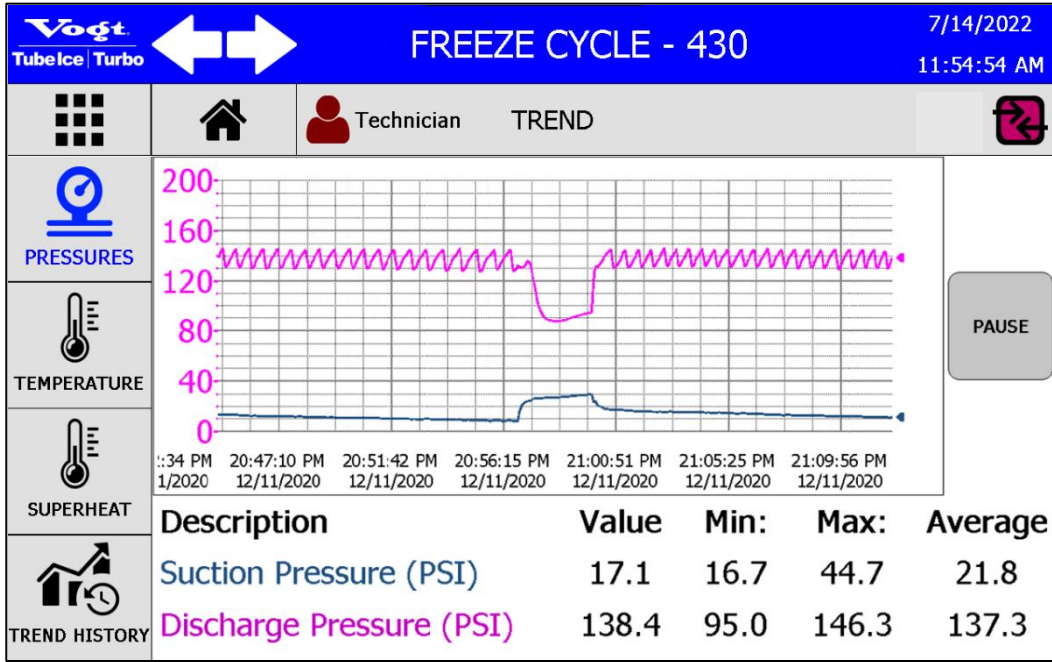

Figure 38: PRESSURE Trend

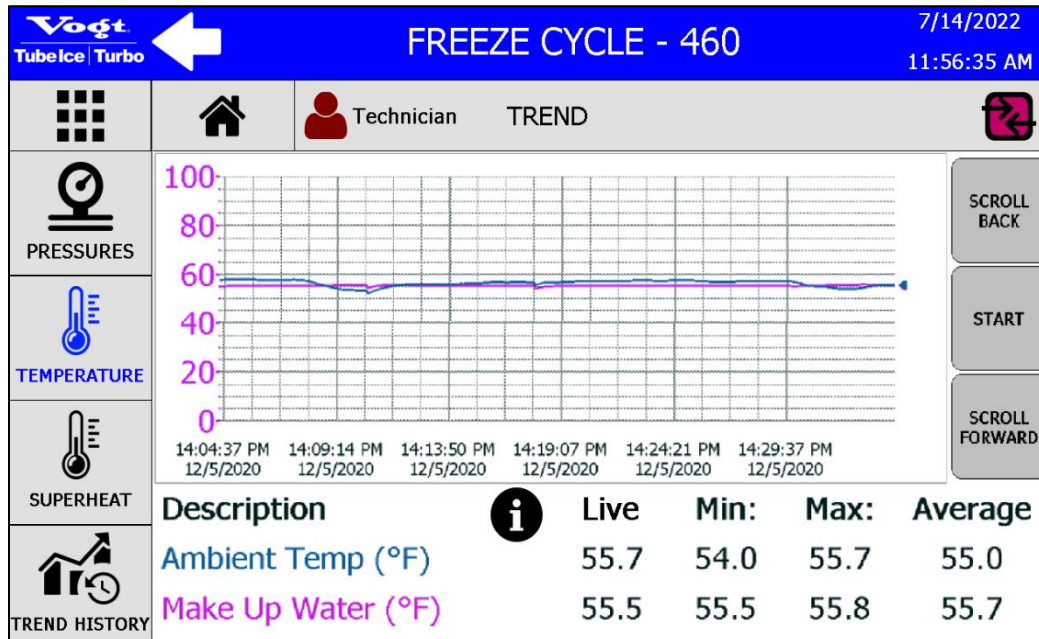

Figure 39: TEMPERATURE Trend

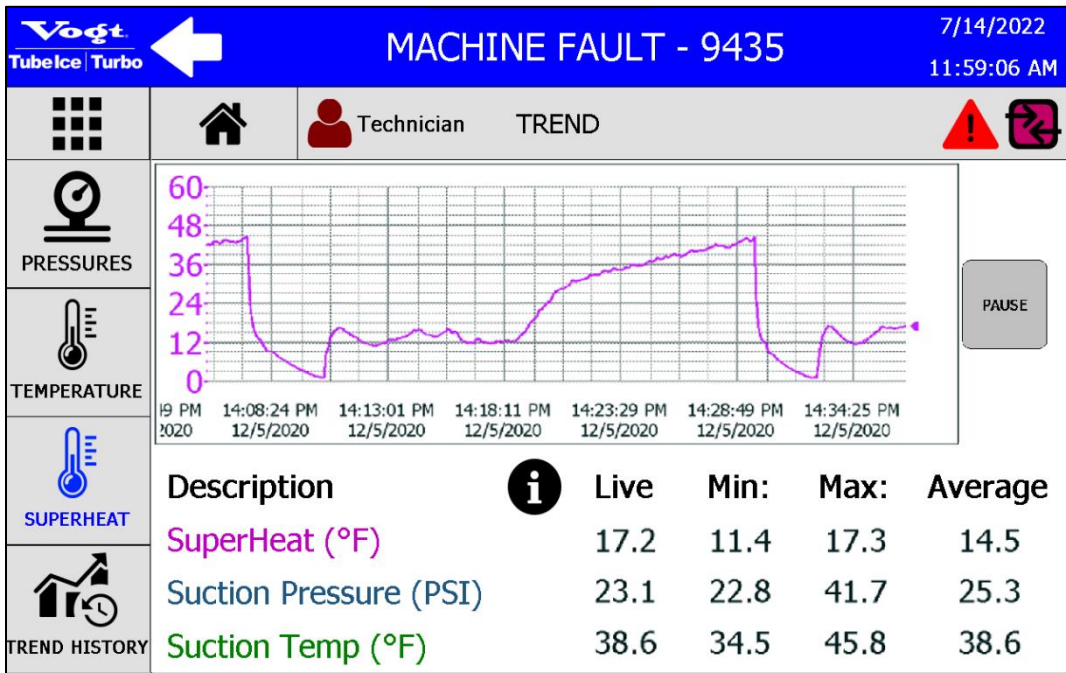

Figure 40: SUPERHEAT Trend

The DATA screen,

Figure 24, provides cycle data for various periods. The information collected by the HMI can be download to a storage device through the USB ports on the front of the control panel or it can be sent by email if the machine is connected to the Internet. See Figure 41 through Figure 44.

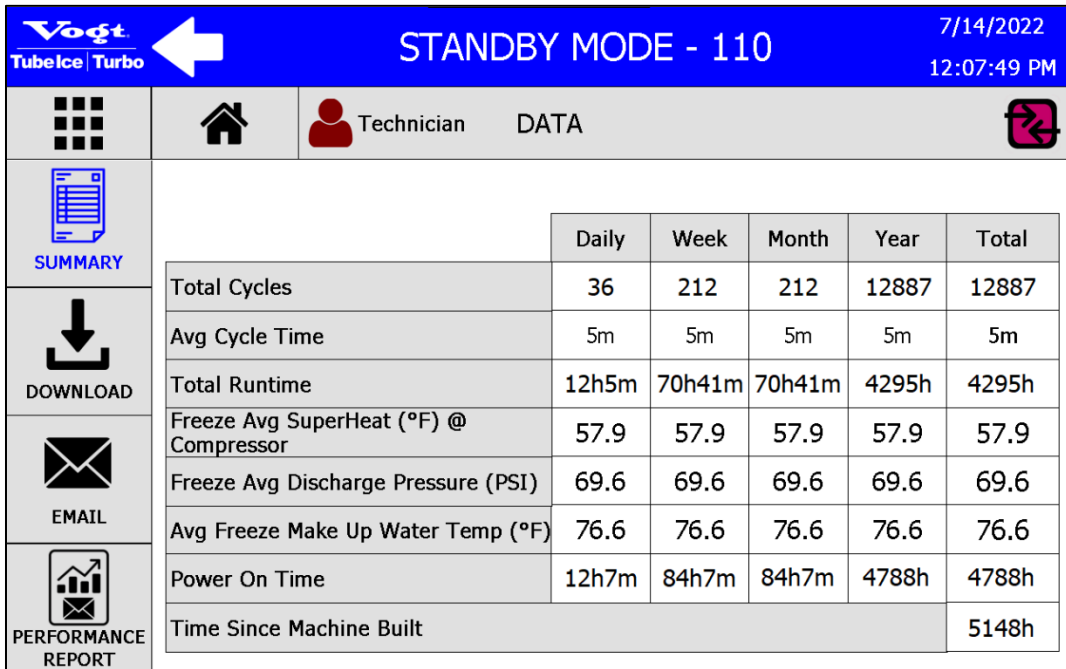

Figure 41: DATA Summary

To download data to an external storage device, follow these steps:

1. Press the **DOWNLOAD** submenu touch screen button on the left side of the **DATA** screen.
2. Insert a storage device in the USB port on the front of the control panel.
3. Select the boxes for the data that is to be downloaded.
4. Press the **DOWNLOAD** touch screen button on the right side of the screen.

The data will be sent directly to the storage device connected to the machine.

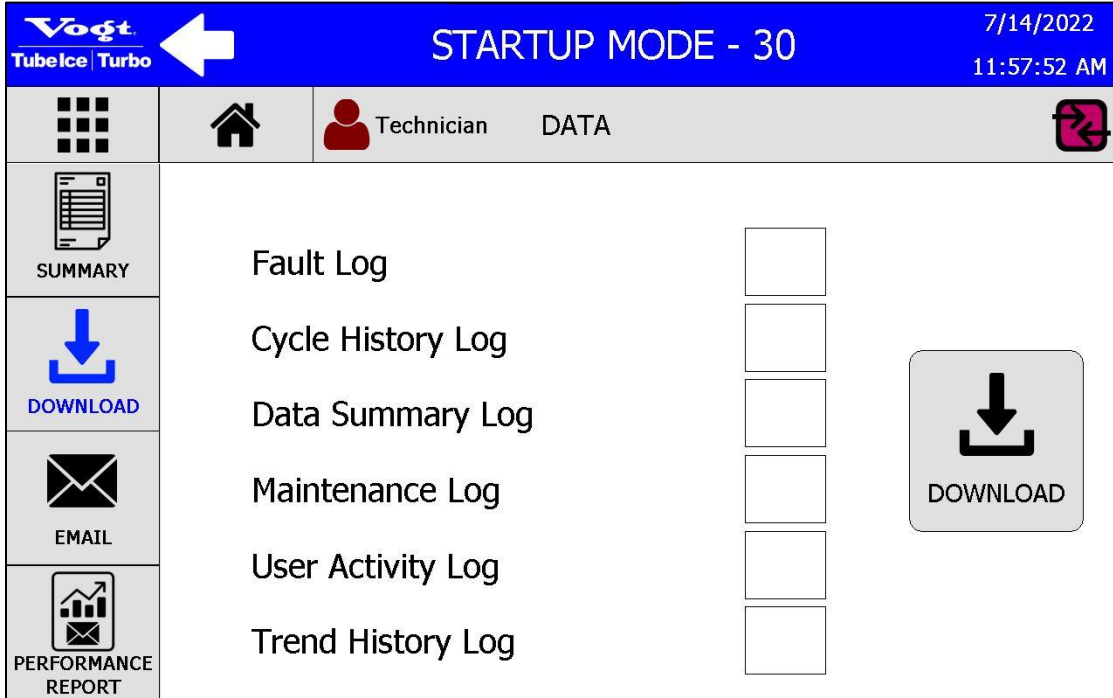

Figure 42: Download

To email data, follow these steps:

1. Log in as the user who should receive the data by email. The selected user must have an email address saved under its profile. Refer to the **USERS** section below for additional details.
2. Press the **EMAIL** submenu touch screen button on the left side of the **DATA** screen.
3. Select the boxes for the data that is to be emailed.
4. Press the **SEND** touch screen button on the right side of the screen.

Note: The data will be sent by email only if the machine is connected to the Internet.

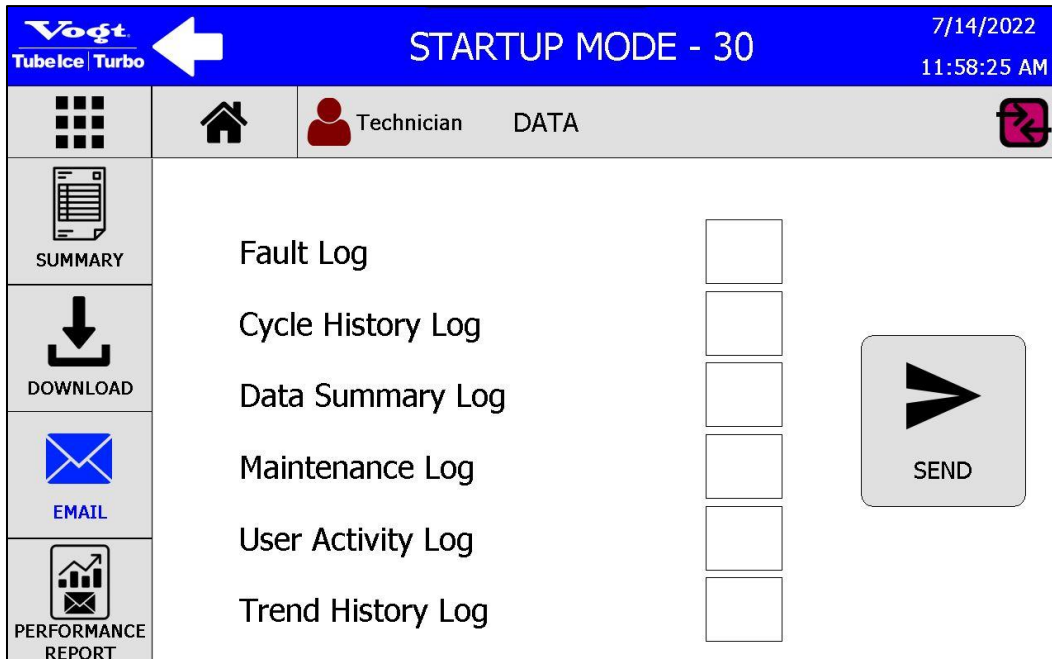

Figure 43: Email

A **PERFORMANCE REPORT** can be generated for each of the options listed in the **Select** window. Select the desired report and press **Create** to generate the report.

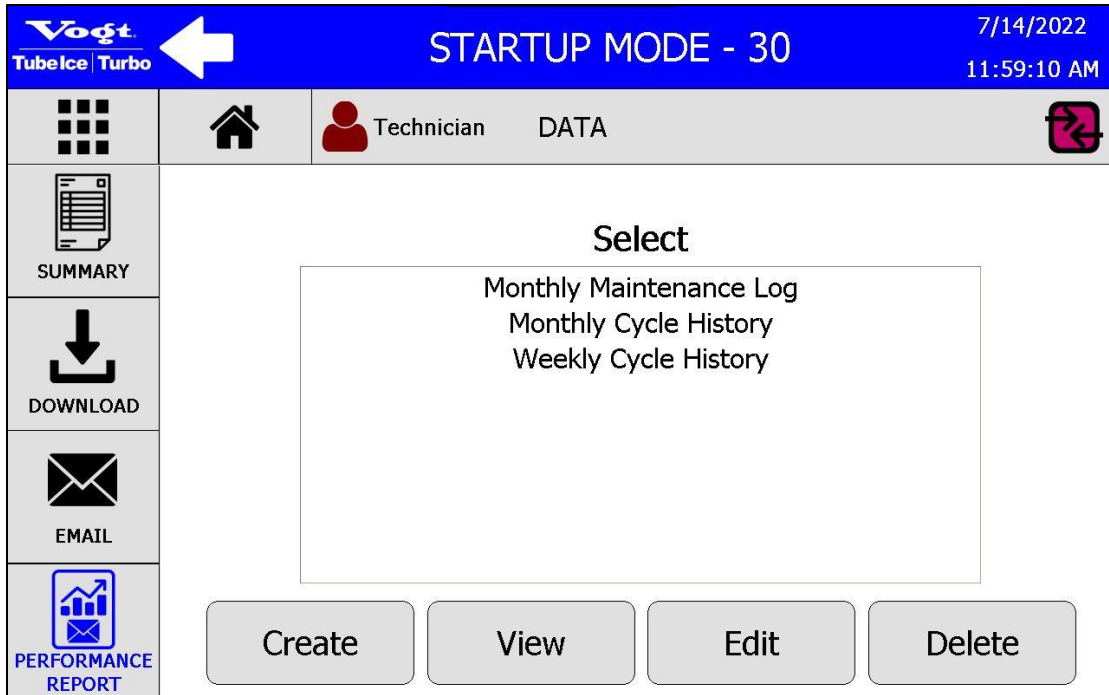

Figure 44: PERFORMANCE REPORT

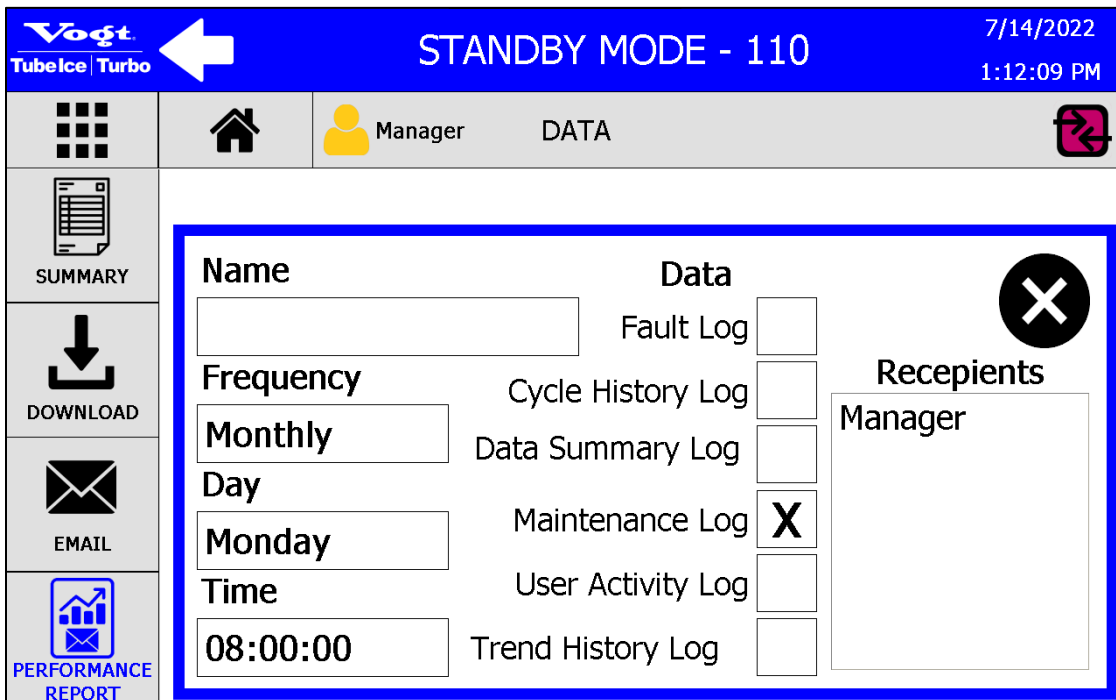



Figure 45: PERFORMANCE REPORT - Create

The **SETUP** screen, Figure 25, allows the operator to adjust all of the parameters of the machine. Using the touch screen, select the gear icon  next to the parameter to be changed and follow the prompts on the screen to adjust the value. Use the arrow buttons  to access other pages within the submenus. See Figure 46 through Figure 49.

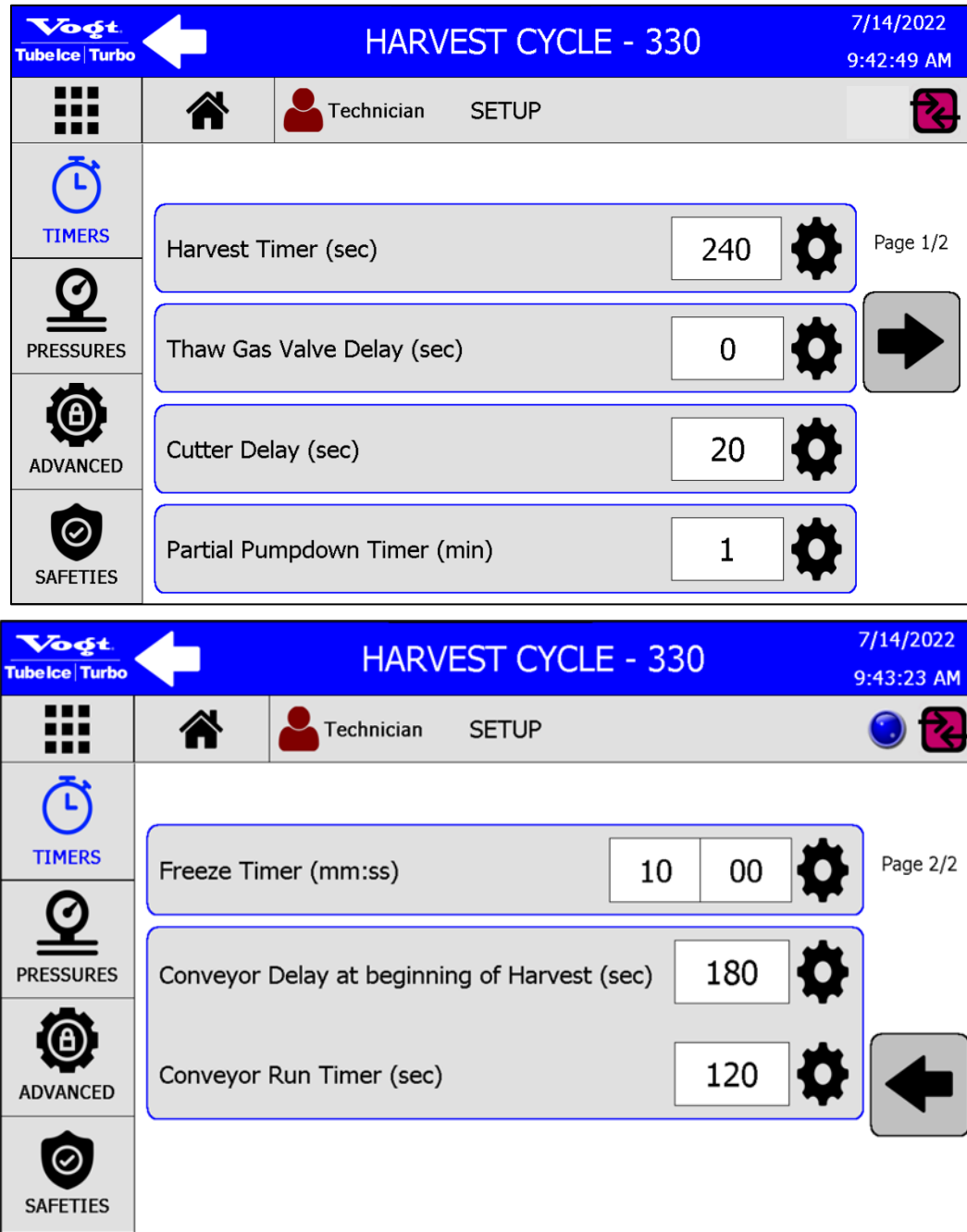

Figure 46: TIMER Settings

The figure displays two screenshots of a control interface for 'HARVEST CYCLE - 330' on 7/14/2022. The interface is divided into a top header and a main content area. The header includes the Voegt logo, a back arrow, the cycle name, the date, and the time. Below the header is a navigation bar with icons for home, technician, and setup, along with a user profile icon and a refresh icon. The main content area is organized into a sidebar with icons for TIMERS, PRESSURES, ADVANCED, and SAFETIES. The PRESSURES section is active, showing four settings with input fields and gear icons. The top screenshot shows settings for Thaw Gas Valve Pressure Cycle ON (36 PSI), Thaw Gas Valve Pressure Cycle OFF (45 PSI), Fan Cycling Control Pressure OFF (140 PSI), and Fan Cycling Control Pressure ON (155 PSI). The bottom screenshot shows settings for PID Resting Position (% Open) (5), PID Set Point (PSI) (150), PID Valve Minimum % Open (20), and PID Valve Maximum % Open (100). Navigation arrows are visible on the right side of the settings panels.

Setting	Value
Thaw Gas Valve Pressure Cycle ON (PSI)	36
Thaw Gas Valve Pressure Cycle OFF (PSI)	45
Fan Cycling Control Pressure OFF (PSI)	140
Fan Cycling Control Pressure ON (PSI)	155
PID Resting Position (% Open)	5
PID Set Point (PSI)	150
PID Valve Minimum % Open	20
PID Valve Maximum % Open	100

Figure 47: PRESSURE Settings

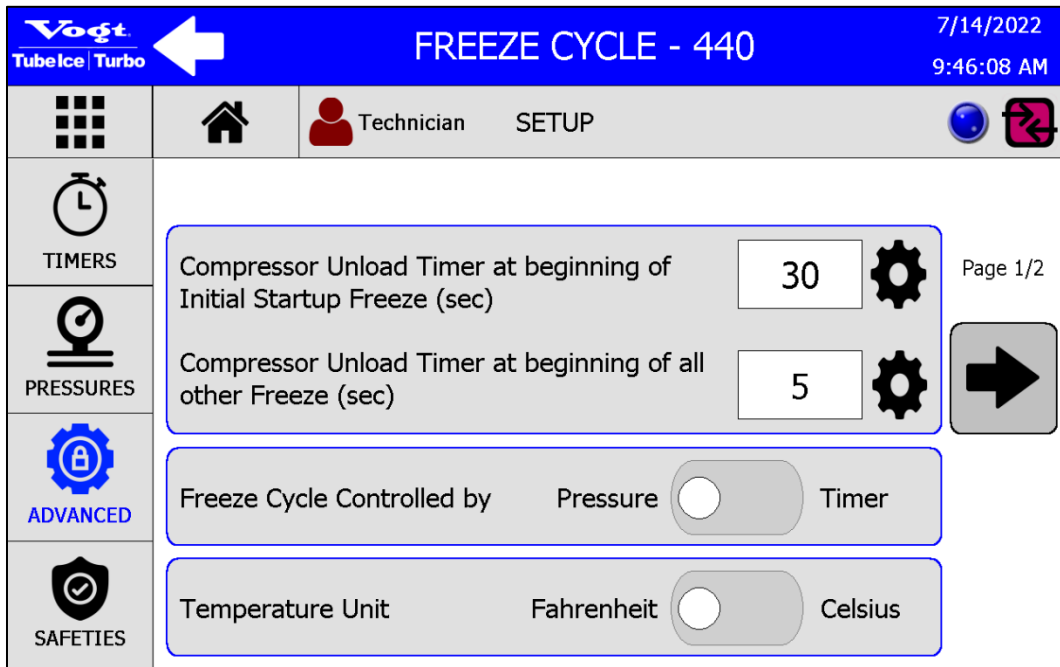

Figure 48: ADVANCED Settings

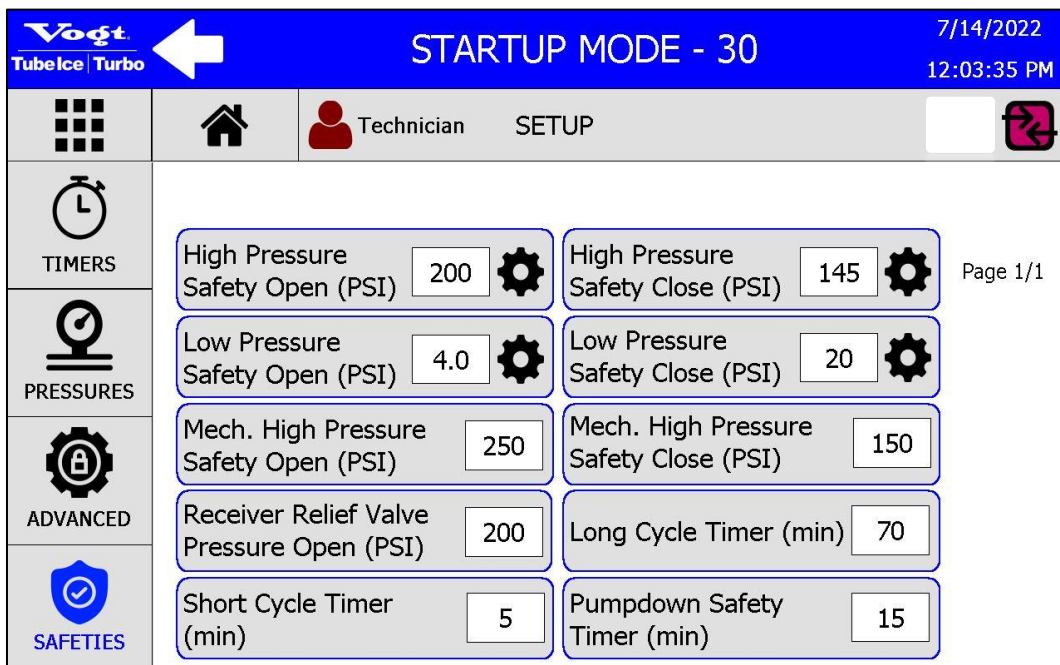

Figure 49: SAFETY Settings

The **CLEAN** screen, Figure 26, allows the operator to enter the cleaning mode of the machine. Refer to Chapter 7 for details on the cleaning process and the menu screens.

The **TROUBLESHOOTING** screen, Figure 27, allows the operator to perform maintenance and service functions. From the **PUMPDOWN** submenu, press the **Enable Maintenance Mode** touch screen button to access the machine maintenance functions. Refer to Chapter 9 for additional information on the **PUMPDOWN** submenu.

Press the **MAINT. LOG** touch screen button to view records of actions that operators have taken on the machine. The **CREATE MAINTENANCE NOTE** touch screen button allows the operator to enter a separate note about service operations that have been performed, such as an oil change. See Figure 50.

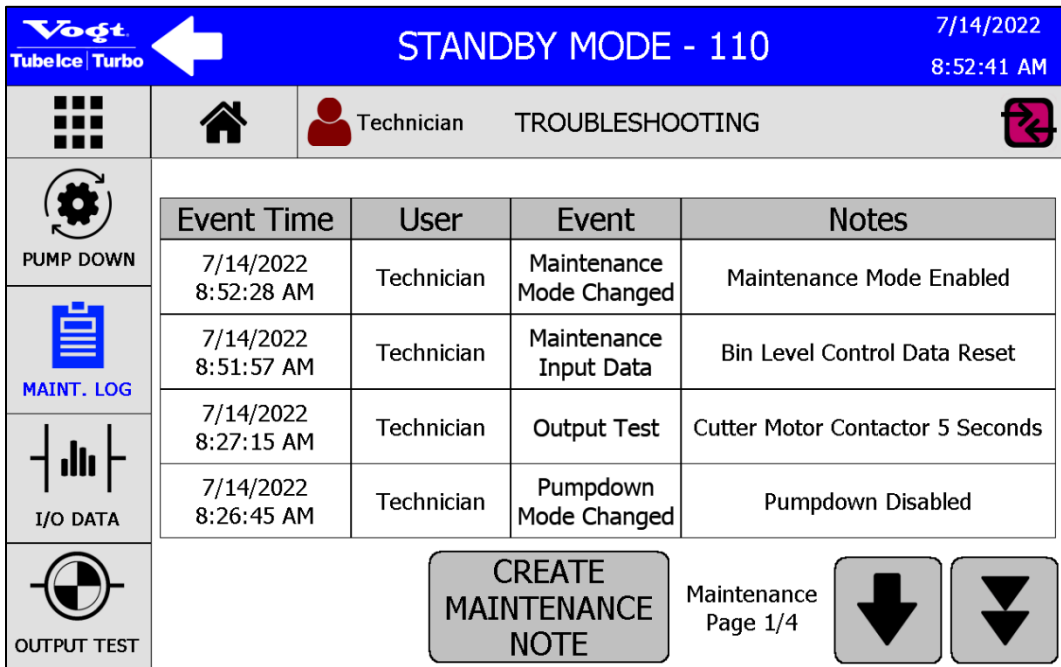

Figure 50: MAINT. LOG Screen

Press the **I/O DATA** touch screen button to view the number of cycles and total run time for each input and output. See Figure 51.

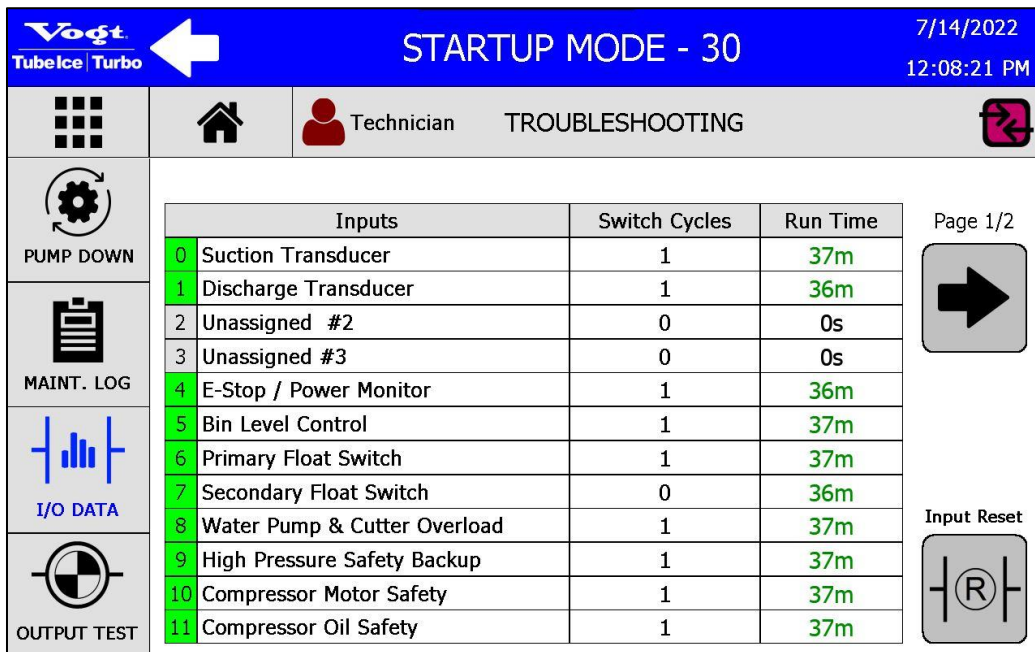

Figure 51: I/O DATA Screen

A reset function is provided for maintenance purposes for the PLC inputs and outputs. The **I/O DATA** screen shows the number of cycles that each input and output have operated. As components are replaced during the lifecycle of the machine, the number of Switch Cycles can be reset as a means of tracking maintenance. Refer to Figure 52 and Figure 53.

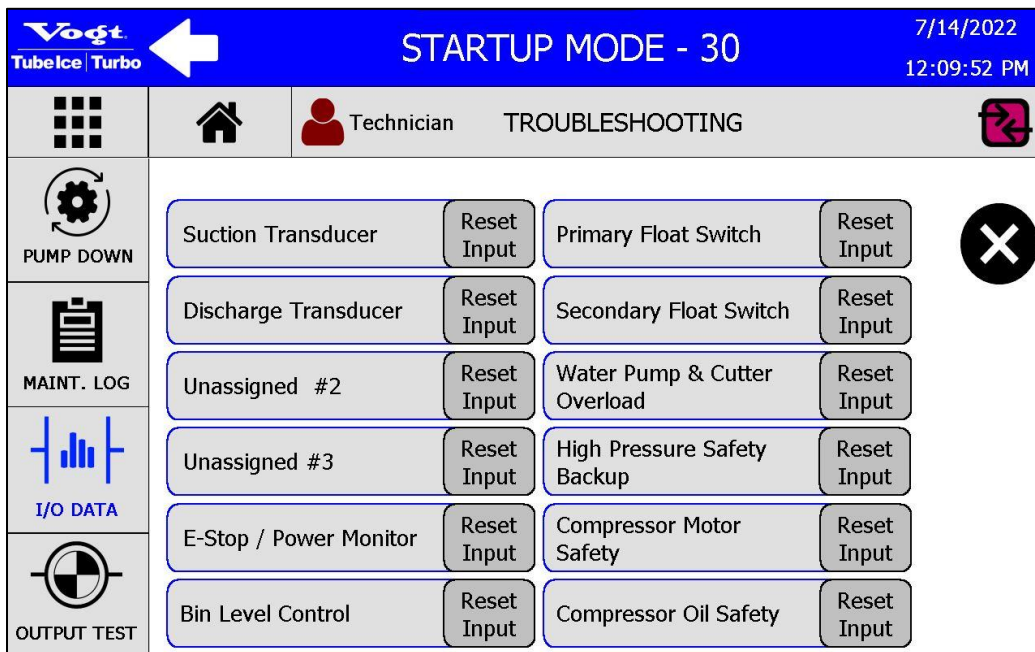

Figure 52: I/O DATA Screen – Input Reset

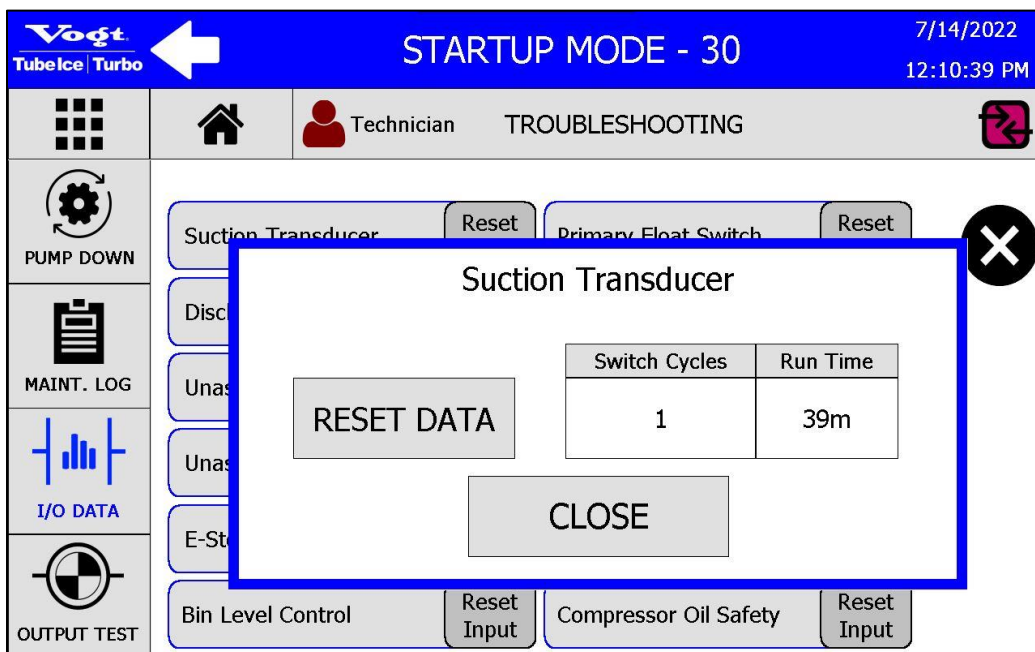

Figure 53: I/O DATA Screen – Input Reset

The **OUTPUT TEST** screen allows the user to turn on individual outputs to check for proper operation. Press the button next to the output to test. Press the gear icon to change the duration that the output is turned on. The Compressor Contactor output can only be energized for a maximum of 5 seconds with a 1 minute delay between each test to prevent damage to the compressor. See Figure 54.

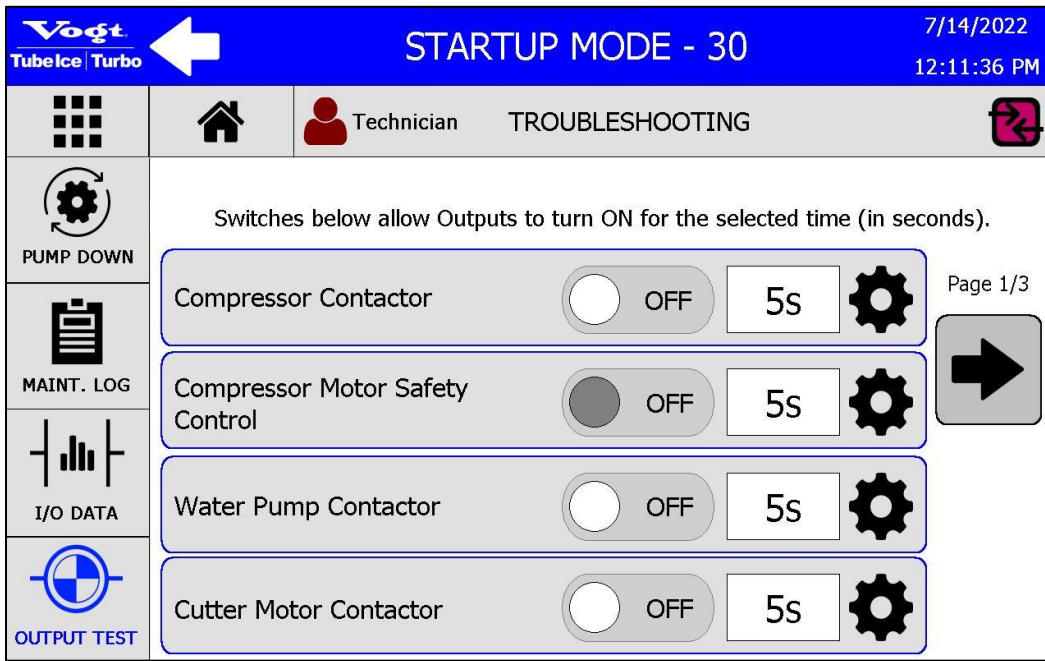

Figure 54: OUTPUT TEST Screen

The **FAULT** screen, Figure 28, displays the historical fault data for the machine. The last 20 fault records are displayed in this menu. The remainder of the fault history is saved internally and can be downloaded or emailed in the **DATA** submenu.

The **INFO** screen, Figure 29, displays basic information about the ice machine. Press the **DOCUMENTS** touch screen button to access a QR code to view the machine service manual and specification sheet from a mobile device. A download link can also be emailed. See Figure 55.

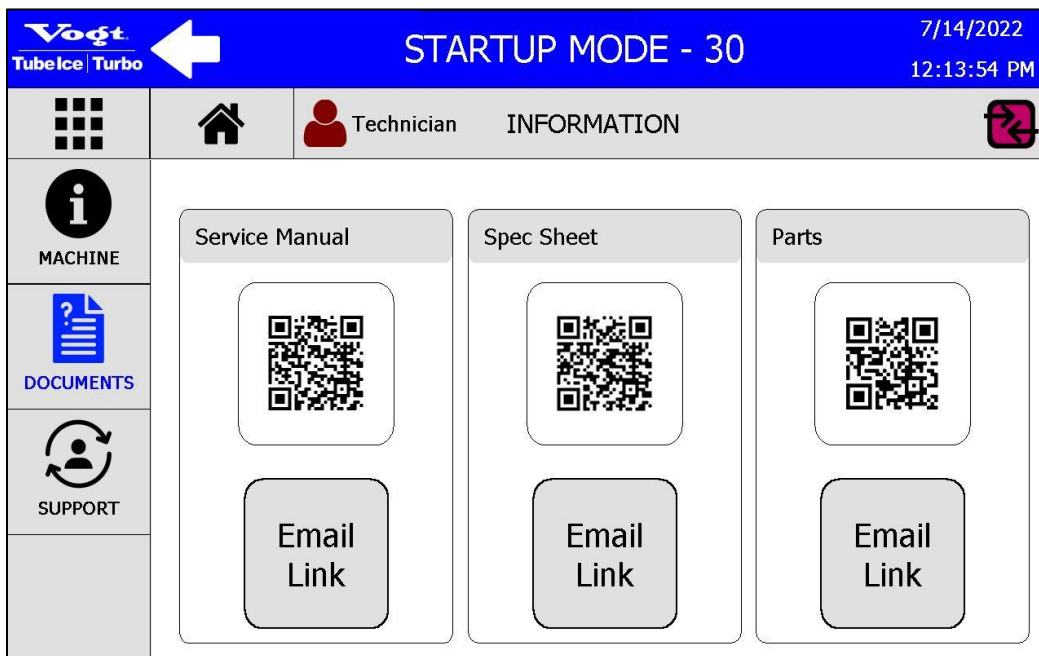

Figure 55: DOCUMENTS Screen

Press the **SUPPORT** touch screen button to display the contact information for Voegt SuperCare Technical Support and Parts. See Figure 56.



Figure 56: SUPPORT Screen

The **SYSTEM** screen, Figure 30, provides access to machine user groups and remote access capabilities. To enable **Fault Notifications** or **Maintenance Notifications** to be sent by email, press the button next to **EMAIL**.

Press the button next to **Remote Access** to enable remote users to connect to the machine.

Note: The machine must be connected to the Internet to enable email and remote access capabilities.

To return the machine to the factory settings, press the **Default Settings** touch screen button.

Press the **USERS** touch screen button to set up user groups for the machine, if desired. See Figure 57. Four user groups are available:

- **Operator**
- **Technician**
- **Manager**
- **Vogt**

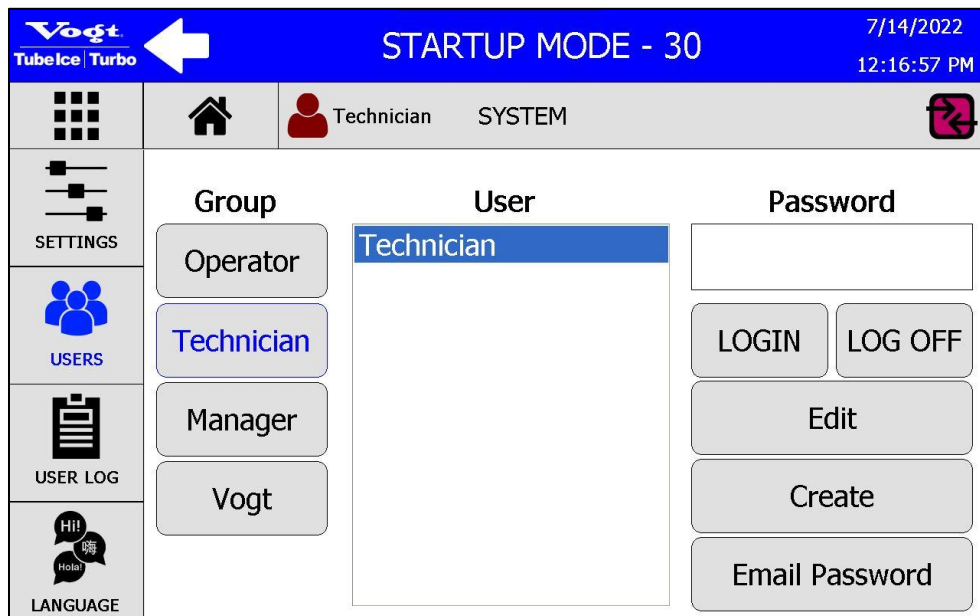

Figure 57: USERS Screen

To log in as a specific user, follow these steps:

1. Select the **Group** and the **User** to log in.
2. Press anywhere in the **Password** box and enter the **User** password.

Specific users can be added to each group. To add a user, log in as **Manager**, and follow these steps:

1. Select the **Group** touch screen button for the new user.
2. Press the **Create** touch screen button and follow the prompts to set up a new name and password. The new name will appear under the **User** section of the screen.

To edit the permissions of a specific user or group, follow these steps:

1. Log in as a specific user according to the instructions above.
2. Press the **Edit** touch screen button.
3. Select the desired permissions and settings for the user according to the prompts.

The default users **Operator**, **Technician**, and **Manager** cannot be deleted.

Press the **USER LOG** touch screen button to access records of the users that have accessed the system. See Figure 58.

Event Time	User	Event
7/14/2022 8:55:32 AM	Manager	Logged In
7/14/2022 8:55:28 AM	Technician	Logged Out
7/13/2022 8:16:45 AM	Technician	Logged In
7/13/2022 8:16:43 AM	View_Only	Logged Out

Figure 58: USER LOG Screen

The **LANGUAGE** screen allows each user to set a language in the system that will be applied after logging in. The applied language will remain in place until the user is logged out of the system. Refer to Figure 59.

Figure 59: USER Language Screen

The **SCHEDULE** screen allows the user to create a schedule for the machine to automatically start and stop at defined times and days, or to start at a certain time and to run for a specified number of cycles.

Users can turn the production schedule off and on from this screen, as well as from the **HOME** menu.

The machine will always complete a freezing and harvest period, followed by a partial pumpdown before shutting down. This may result in the ice machine running for a few minutes after the specified ending period of a scheduled operation. Refer to Figure 60 and Figure 61.

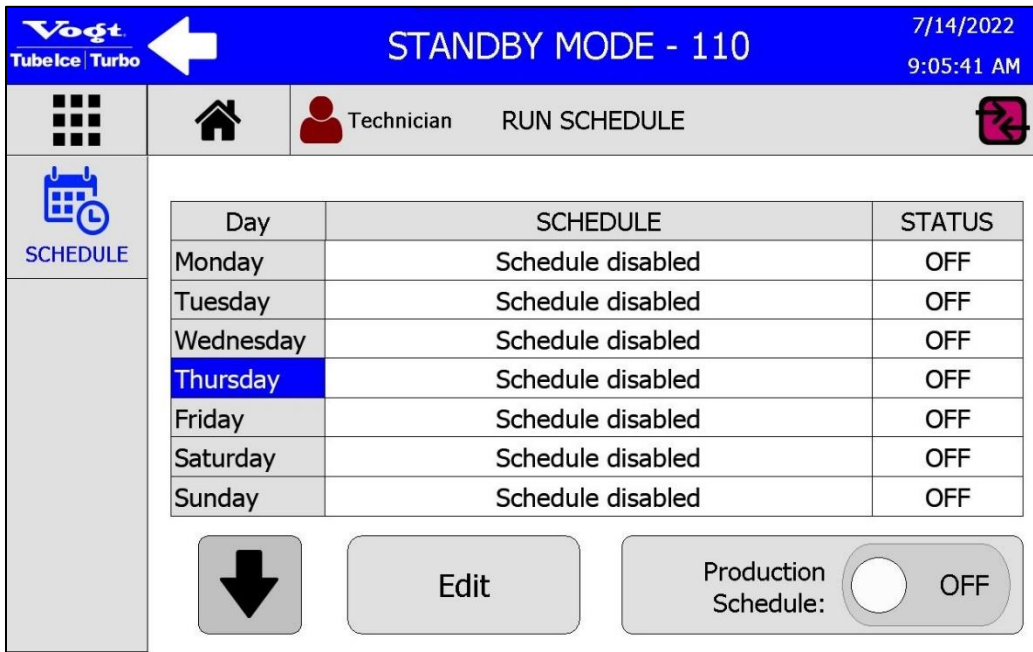

Figure 60: SCHEDULE Screen

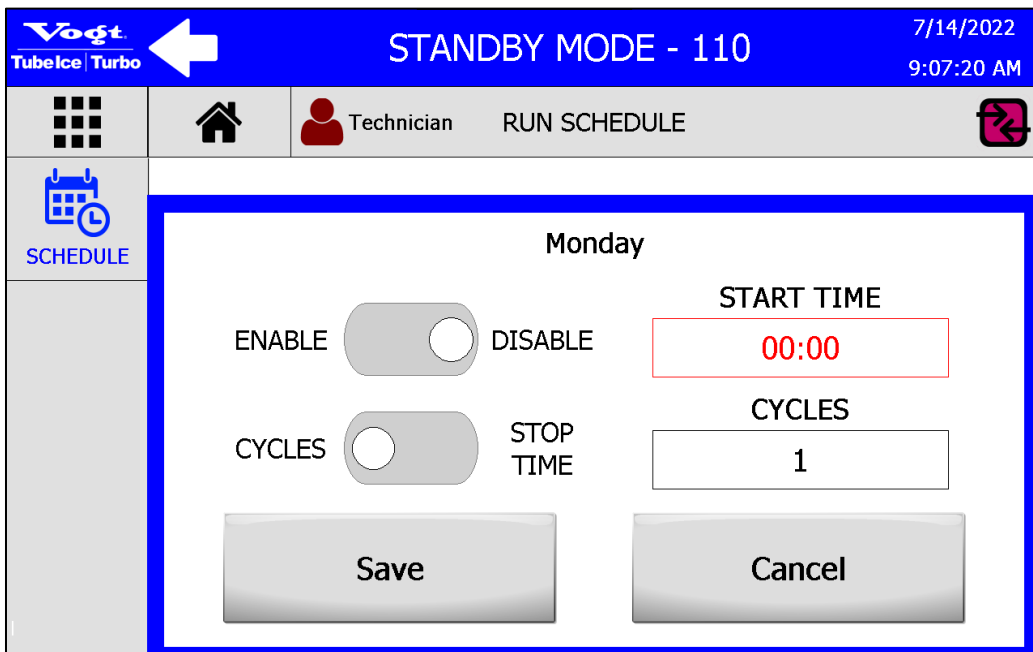

Figure 61: SCHEDULE Screen – Edit

Control Panel Details

The control panel contains additional components that allow the machine to operate properly. Table 6 explains these components and their functions.

Table 6: Control Panel Component Functions

Component	Function
AX	Auxiliary trip indicator for manual motor starters. Switch opens, turning off the motor when cutter or pump motor starter trips.
CB	Overload and short circuit protection for control circuit and crankcase heater. (400/460V machines only)
C	Provides power to the compressor motor. Continuously energized during freezing and thawing. Auxiliary contacts control main power for control circuit components, crankcase heater, control relay, and harvest timer.
CU	Fan motor starter (manual motor starter and contactor). Starts and stops cutter motor. Provides short circuit and over current protection. Stops cutter motor and ice machine in the event of a mechanical or electrical malfunction that results in excessive motor amperes.
E-STOP	Emergency Stop button. When pressed, the button lights and power to the PLC outputs is removed, shutting machine off. Note: Power to the PLC & Touch Screen HMI will remain ON. The button must be manually reset (twist) and the E-Stop fault reset on the Touch Screen.
FC	Cutter motor starter (manual motor starter and contactor). Cycles the fan motor(s) of air-cooled condenser on and off. Automatically activated by the PLC (air-cooled machines only). Provides short circuit and over current protection. Stops fan motors in the event of a mechanical or electrical malfunction that results in excessive motor amperes.
FU01&02	Overload and short circuit protection for the control circuit transformer.
FU-HMI & PLC	Short circuit protection for Touch screen HMI & PLC
FU-Y0 to Y10	Short circuit protection for PLC outputs
HMI	Touch Screen. Allows you to control the ice machine. This device allows you to view and/or input machine operating parameters, view machine cycle, maintenance, fault history, etc.
P	Pump motor starter (manual motor starter and contactor). Starts and stops pump motor. Provides short circuit and over current protection. Stops water pump motor in the event of a mechanical or electrical malfunction that results in excessive motor amperes.
PLC	Programmable Logic Controls. Controls all sequencing operations of the ice machine.
TB1	Low Voltage terminal block, is for 24VDC & 5VDC connections. Used primarily for PLC Input device, sensor & switch connections. Allow for component wire connections and ease of troubleshooting.
TB2	Main Control Voltage terminal block is for 120/240V control circuit components. Used primarily for PLC Output connections. Allow for component wire connections and ease of troubleshooting.

Component	Function
TB3	Customer Connection terminal block, is of water pump, cutter motor and compressor interlock connections.



Chapter 7 Maintenance

To achieve the best performance from your machine, follow the maintenance instructions listed in this chapter. For questions concerning the maintenance or upkeep of your equipment, contact Vogt Ice, LLC.

Cleaning

The ice-making section of the Tube-Ice® machine should be cleaned at least twice a year (more often if water conditions cause mineral build-up). Use an approved food-grade ice machine cleaner. The machine is equipped with a cleaning mode, which circulates the cleaning solution through the freezer to remove mineral scale using the water pump. Detailed instructions are also attached to the machine.

To clean your Tube-Ice® machine, follow these steps:

1. Press the **HOME** touch screen button  to return to the **HOME** screen. Turn off the machine by pressing the **OFF** button on the **HOME** screen. Allow the machine to cycle off.
2. Press the grid touch screen button  to return to the **MENU** screen. Press the **CLEAN** touch screen button to access the cleaning submenu. See Figure 62.

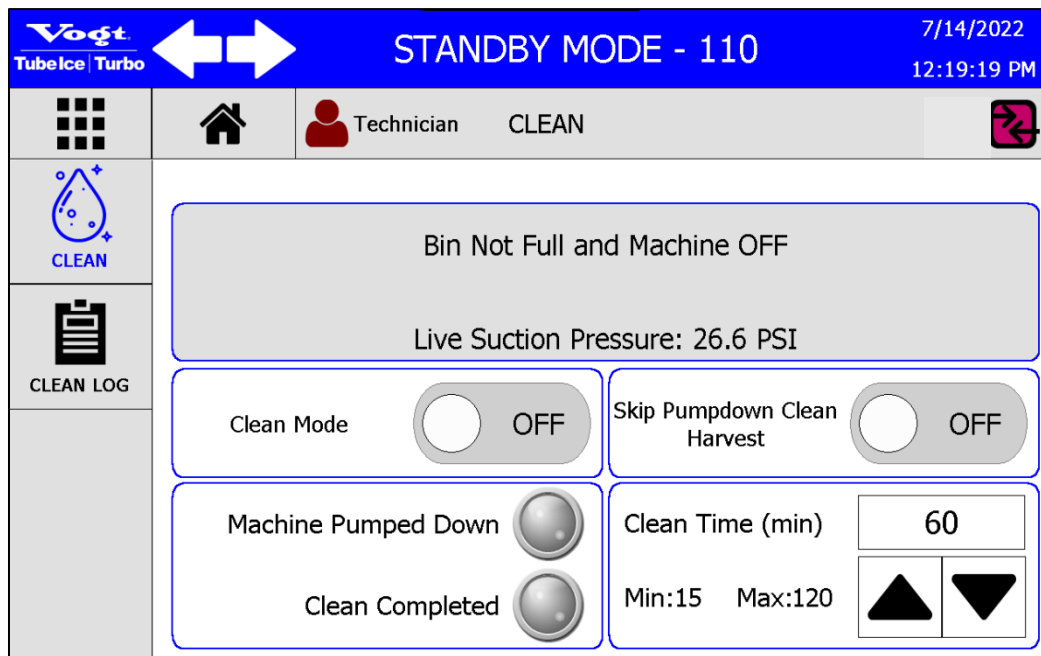



Figure 62: CLEAN Screen

3. Select the amount of time to clean the machine by pressing the arrows   in the **Clean Time** section of the screen. The cleaning cycle time can be set from 15 minutes to 120 minutes.
4. Remove ice from the storage area or cover the storage opening.
5. Shut off the water supply and drain the water tank by opening the drain valve. Remove any loose sediment from the tank.
6. Close the drain valve and fill the water tank with warm water to promote faster cleaning. The tank holds approximately 61 gal (231 L).
7. Cover the ice discharge opening to prevent water from splashing out into the ice conveyor system.
8. Close the petcock valve on the water pump during the cleaning period.
9. Add the ice machine cleaning solution to the water tank according to the directions of the cleaning solution manufacturer. Vogt recommends Nu-Calgon® Ice Machine Cleaner, which is a food-grade liquid phosphoric acid.

10. Inspect the water distributors by looking through the transparent freezer cover. It may be necessary to clean the cover before inspecting. If required, remove the cover. Clean and remove any solid particles from the two orifices in each distributor. Clean the rubber cover gasket and reinstall the cover.
11. Press the button next to **Clean Mode** to enter the cleaning mode. The machine will begin with a pumpdown cycle if connected to the optionally available HFOPAK50 remote high side. The operator can choose to bypass the pumpdown harvest cycle by pressing the button next to **Skip Pumpdown Clean Harvest**.
12. After the machine has pumped down, the icon next to **Machine Pumped Down** will turn blue, the compressor will turn off, and the water pump will begin circulating the cleaning solution. Refer to Figure 63.

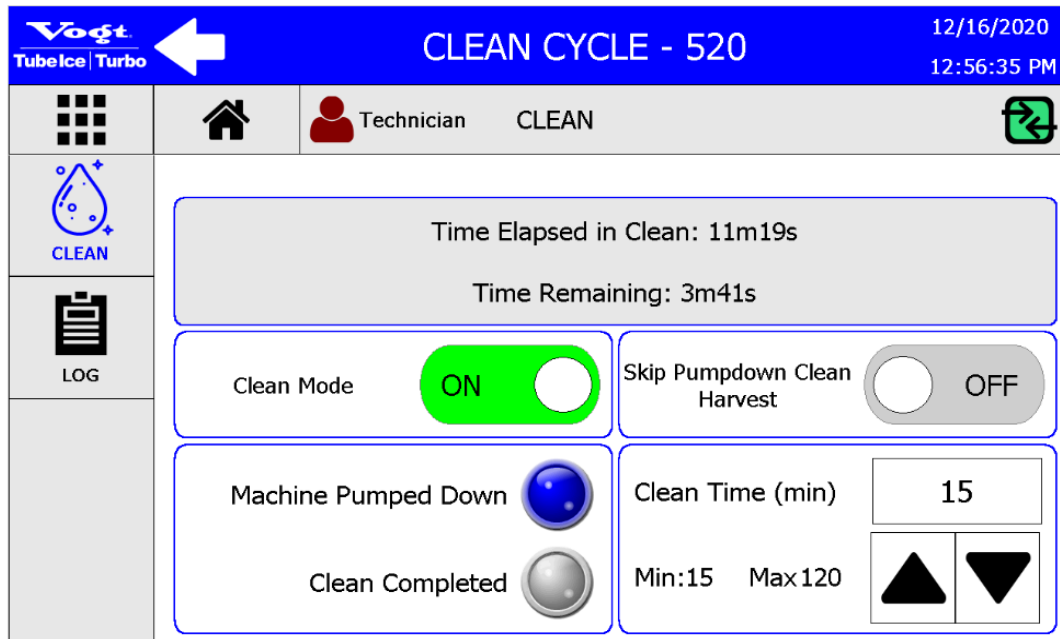

Figure 63: CLEAN Screen – Machine Pumped Down

13. When the machine has completed a cleaning cycle, the icon next to **Clean Completed** will turn blue and the machine will automatically turn off the **Clean Mode**. See Figure 64. Repeat cleaning if necessary.

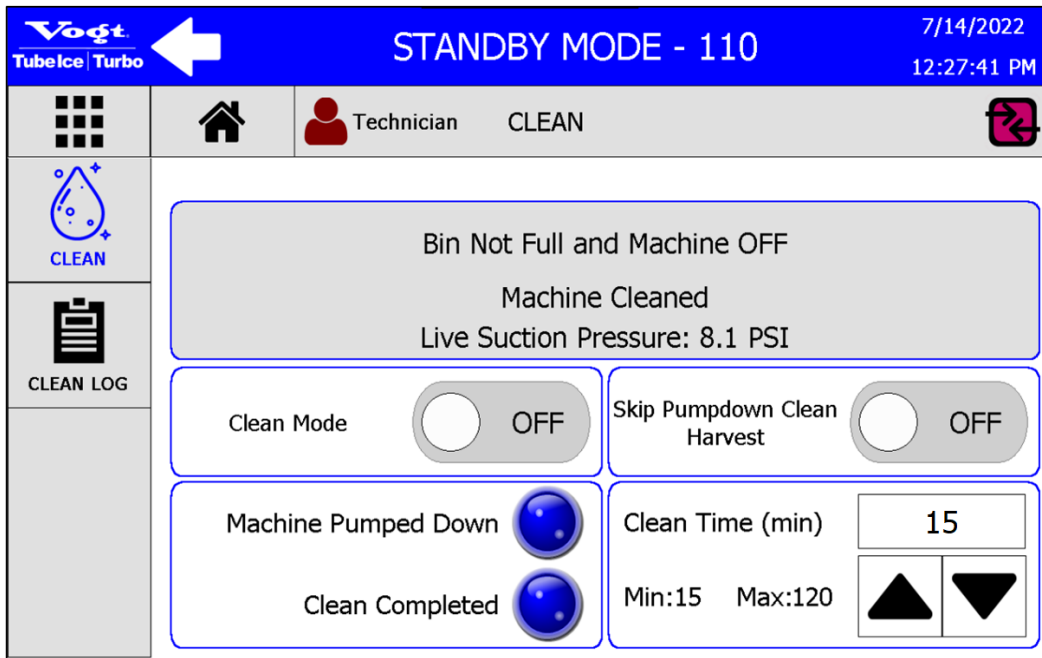

Figure 64: CLEAN Screen – Clean Completed

Note: To exit the cleaning mode at any time during the cleaning cycle, press the button next to **Clean Mode**.

14. After the cleaning cycle is complete, drain and flush the water tank with fresh water.
15. Open the water supply to the machine.
16. Drain, flush tank again, and refill it with fresh water.
17. Clean the inside of the ice storage area and remove any solution that entered during the cleaning process. Remove the cover, if one was installed, over the opening into the storage area.

After a cleaning cycle has been completed through the HMI, the PLC will store the cycle as an entry in the **CLEAN LOG** menu shown in Figure 65.

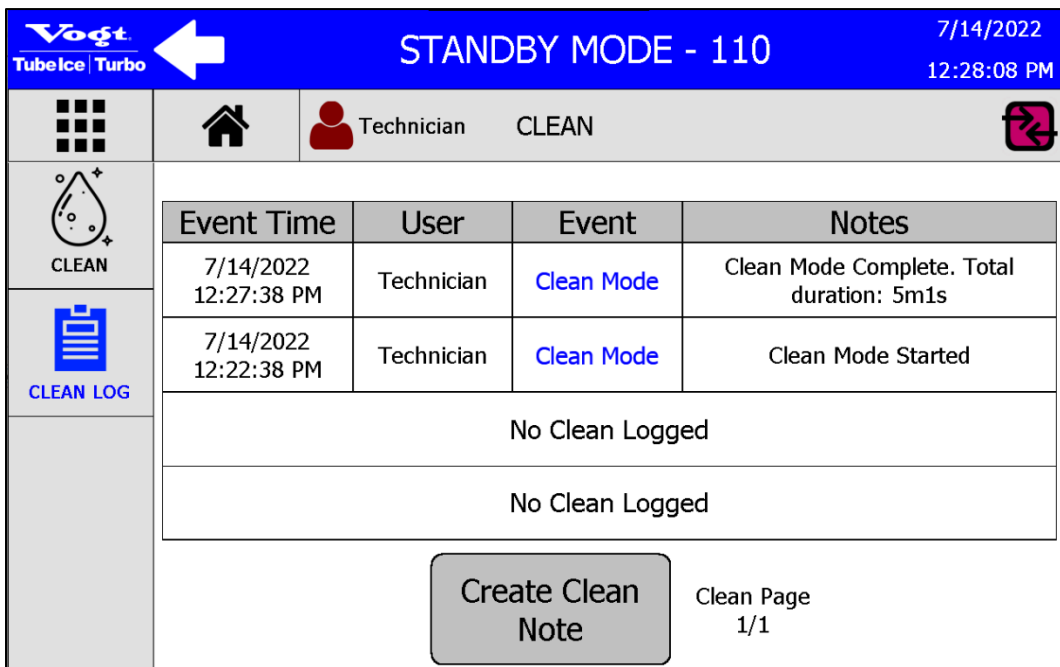



Figure 65: CLEAN LOG

To return the machine to ice-making operation, follow the steps below:

1. Make sure the water tank drain valve is closed.
2. Turn on the water supply and refill the tank with clean water.
3. When the water tank is full, press the **HOME** touch screen button  to return to the **HOME** screen.
4. Press the **ICE** touch screen button to start the machine. The PLC automatically opens the liquid feed valve briefly to re-pressurize the evaporator. No additional action, such as valve adjustment, is required by the operator.
5. Once the evaporator has re-pressurized automatically, the machine will immediately resume normal operation.

Check that the adjustable blowdown petcock valve on the recirculating water pump is adjusted properly. The valve should be adjusted to the minimum rate required to maintain production of clear ice. This should be no more than 1 gal (3.8 L) per minute for most water sources.

Water Distributors

The water distributors are located under the freezer cover at the top of the freezer. These distributors may require occasional or periodic cleaning to remove solids and foreign particles accumulated from the makeup water. The frequency of this cleaning operation will depend on the characteristics of the water supply (refer Vogt Ice's water quality bulletin). The cleaning operation is needed when:

- Inside diameter of a large proportion of the ice becomes irregular
- Some of the ice is opaque
- There is a notable decrease in ice capacity

The water distributors on the P34HL have a small vent tube that must remain in place in each distributor for proper operation. The distributors tubes can become clogged in addition to the inlet holes on the sides of each distributor.

To clean the water distributors:

1. Shut down the machine and remove the freezer cover on the top of the freezer.
2. Remove the water distributors (one per tube) with pliers. Grip the top of the distributor body only. **DO NOT GRIP THE VENT TUBE FOR REMOVAL.**
3. Use the pliers on the top part of the distributor with a twisting upward motion, taking care not to damage the orifices, the distributor body, or the vent tube.
4. Soak the distributors in ice machine cleaner to remove mineral buildup if needed.
5. Rinse distributors thoroughly before reinstalling. A short piece of pipe or conduit can be used to tap them in without damaging the vent tubes. Tap in lightly with a rubber mallet to seat in the freezer tubes.

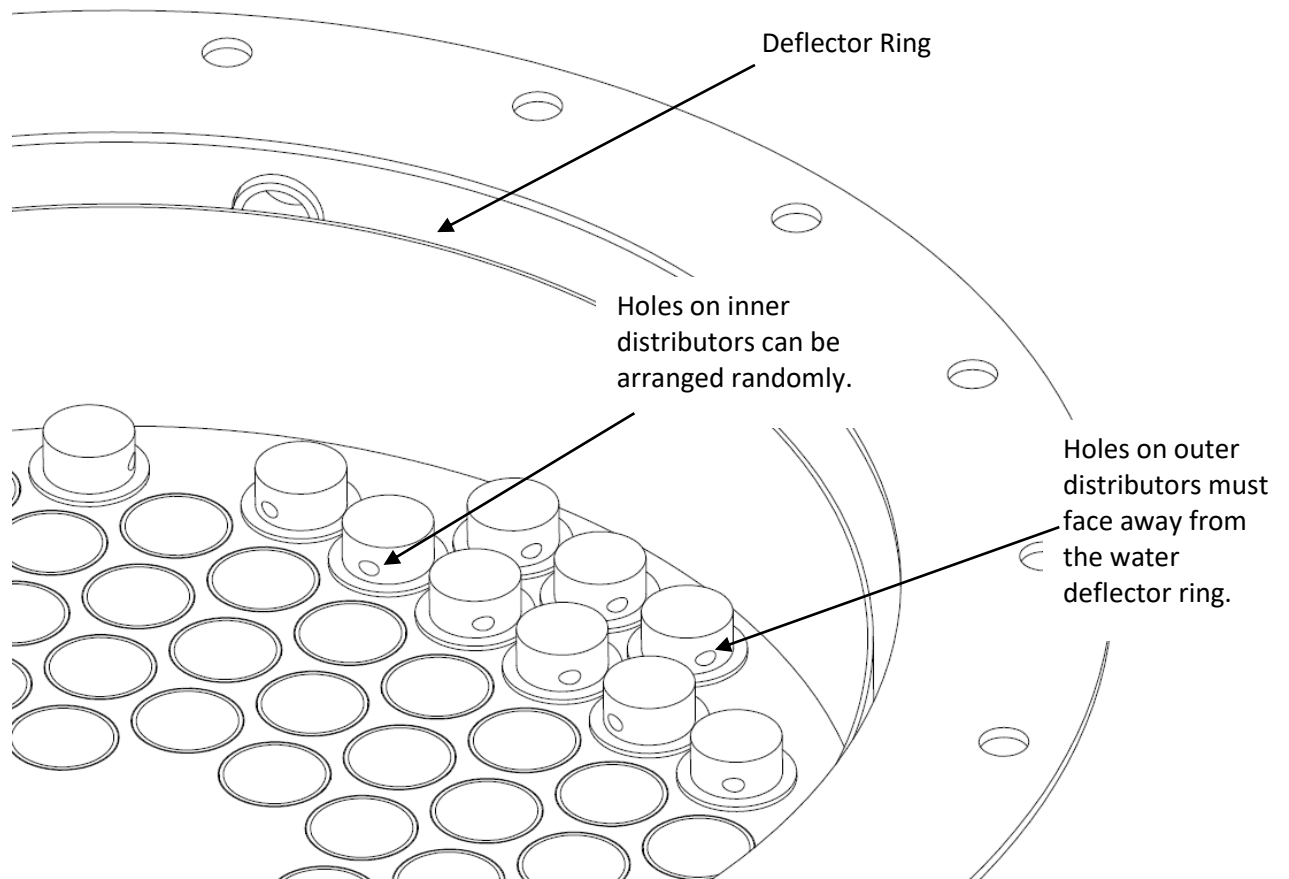

Figure 66: Water Distributor Detail (Vent Tubes not Shown)

Table 7 shows the part numbers and tube quantities for water distributors.

Table 7: Water Distributor Information

Tube Size in. (mm)	Number of Tubes	Vogt Part Numbers		
		Water Distributor	Freezer Cover	Freezer Cover Gasket
1 (25)	564	12B2185V12	12B2145C07	12A2600G1

Water Tank

The production of opaque ice indicates the water in the water tank contains a concentrated number of solids or salts. To remedy this problem, follow the steps below:

1. Shut down the machine.
2. Remove the cover plate on the water tank and open the drain valve.
3. Clean the tank thoroughly by flushing it out with a hose and scrubbing it with a stiff brush. It may be necessary to completely remove the water tank in order to clean all internal surfaces.
4. After cleaning, reinstall the tank if necessary, close the drain valve, and fill the tank with fresh water.
5. Press the **HOME** touch screen button  to return to the **HOME** screen and press the **Run Pump** touch screen button to check if the pump is working properly. Air may have collected in the impeller housing, and the pump may have to be stopped and started several times to expel this air.
6. After the pump is checked for proper flow, press the **Run Pump** touch screen button to turn the pump off.
7. Press the **ICE** touch screen button to resume ice production.

Freezer Cover

A clear polycarbonate freezer cover is provided for visual inspection of the water box and water distributors located at the top of the freezer. The cover should be removed and cleaned if it becomes coated with deposits. Generally, if this cover is coated with solids, this is a major indicator that other water contact areas (i.e., water tank and distributors) also require cleaning.

Water-Cooled Condensers

The interval in which condensers require cleaning varies. Some installations seldom need cleaning, while others may require cleaning at least once a year or even several times a year.

Proper operation of cooling towers increases the interval between cleaning considerably. Check the tower overflow rate frequently. If a tower operates with insufficient overflow (nominal 1.5 to 3 gph [5.7 – 11.4 Lph], depending on water quality), the resulting mineral concentration in the water can cause rapid and heavy fouling inside the condenser tubes, requiring excessively frequent cleaning. Also, these conditions often lead to severe corrosion.

Chemical additives, including those used to stop algae and related growths, should be obtained only from a reputable, established supplier. Always follow manufacturer's directions. Excessive treatment of the water can cause more harm than good, and the condensers, pumps, piping, and towers themselves may be damaged.

Double check the system to make sure that fouling is actually causing the trouble. High head pressure alone does not mean a fouled condenser.

Before cleaning, always check for the following conditions:

- Non-condensables in the system or a faulty head pressure gauge—Check standby pressures against refrigerant tables.
- Incorrectly set or defective water regulator valve—Check setting and operation.
- Partly closed compressor discharge service valve—Check the stem position to confirm that it is backseated.
- High-temperature water entering the condenser. Check the cooling tower fan and system.

If none of these problems exist, or they have been resolved, determine the temperature difference between the water leaving the condenser and the refrigerant condensing temperature (saturation temperature [refer to

Table 16: Pressure-Temperature Chart], corresponding to the head pressure). If this difference exceeds 10°F (5.6°C), cleaning is required because the difference indicates that good heat transfer is not occurring.

If the difference is less than 8°F (4.5°C), something other than a fouled condenser may be the cause of high head pressure. During normal operation, the temperature difference stays between 5°F and 10°F (2.8°C and 5.6°C) regardless of water inlet temperature, when the water flow is regulated by a pressure-operated water valve. If the difference is less than 5°F (2.8°C), restricted water flow or a low supply pressure is likely. A restriction can be caused by foreign matter in the condenser, but it is likely to be elsewhere in the system.

Draining

Draining of water-cooled condensers is recommended in climates where units may be left exposed to ambient temperatures below 32°F (0°C). Although condensers usually have a vent and drain fittings, the opening of these fittings is not sufficient for a natural gravity flow of water. Water is thus retained in the tube due to the surface tension between the tube and the water and the normal curvature between tube supports.

Experience shows that as much as 20% of the water in the condenser is retained. To break the surface tension between the water and the tubes and to drain all tubes completely, the condenser must be tilted a minimum of 5 degrees. Whether water left in the tubes causes damage depends on how quickly the water freezes and its location inside the condenser. Condenser manufacturers recommend that each tube is blown out individually with compressed air to remove the water. Alternatively, a minimum of 25% ethylene glycol in the system will also prevent the water from freezing, which can rupture the tubes.

Chemical Cleaning

Vogt Ice, LLC, makes no recommendation for any particular chemical preparation because the same chemical may not be effective in all circumstances.

CAUTION

The warranty on condensers is void if they are damaged by improper cleaning tools or methods. If harsh chemicals are used, be sure to follow the manufacturer's recommendations regarding safe handling of those solutions.

Follow these directions and precautions when cleaning:

- Use only preparations from an established, reliable source.
- Follow directions exactly, particularly regarding amounts to use, and flushing or neutralizing procedures after cleaning.
- Close the water supply to the stop valve and remove the condenser water regulating valve.
- Circulate the solution through the condenser until it is considered clean (no excess scale on tubes or tubesheets).
- Flush the condenser according to the directions provided by the chemical manufacturer.
- Reinstall the water regulating valve and associated piping.
- Open the water-supply stop valve and check for leaks.

Mechanical Cleaning

The following steps should be followed during mechanical cleaning.

1. Close the stop valve in the water supply line.
2. Drain the water from the condenser.
3. Remove the water regulating valve and associated piping from the condenser.
4. Remove the nuts, water plates, and gaskets from both ends of the condenser.
 - If the gasket does not lift off with the end plate, do not attempt to pry it off. This can damage the sealing surface, causing a water leak. To free a sticking gasket, replace the water plate and tap the outside face of the plate with a rubber mallet or block of wood. After a few taps, the gasket will spring free and slip off with the water end plate.
5. Rinse gaskets with running water and use a rag or soft brush to remove foreign matter.
 - Rust, scale, and dirt will not stick to the gasket material.
6. Use clean water and a rag or soft bristle brush to clean the inside of the water end plates and the outer tube sheet surfaces.

Note: Never use a wire brush or strong caustic on these surfaces.

 - These surfaces have been coated with a special material that will give years of protection against corrosion unless damaged.
7. Flush the condenser tubes clear with air, water, or a piece of rag on the end of a stick or wire. This will sufficiently clean the tubes in many cases.
 - If the inside surfaces are smooth, further cleaning is not necessary, even though the surfaces may be discolored. Do not attempt to achieve a bright copper finish on the tubes as they will quickly discolor when in service. The condenser is designed to handle moderate fouling on these surfaces.
 - If a rough coating remains on the insides of the tubes after flushing and wiping, further cleaning is required. The color will vary depending on water conditions. In these circumstances, use a nylon, brass, or copper brush to clean the tubes. Do not use any tool that will score, mark, flake, or otherwise cut into the tubes.

Lubrication of the Cutter Motor Gear Reducer

The oil level for the gear reducer should be checked to see if a leak exists. The oil level should be at the bottom of the plugged opening in the side of the gear housing. Use Mobile 600W cylinder oil or equivalent. Change the oil once a year.

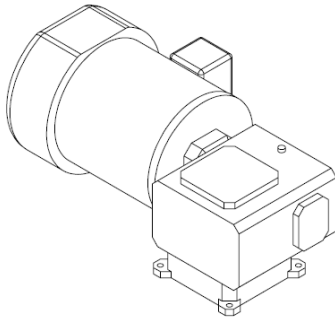

Gear Reducer

Part #: [12A2900M0803](#)

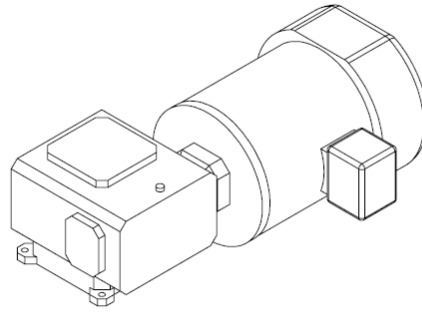

Replacement Food-Grade Oil:

- Part #: [19T3020C01](#)
- Texaco Cygnus 220
- Oil Capacity: 8 oz (227 g)

Figure 67: Cutter Motor Gear Reducer

Preventive Maintenance

A preventive maintenance program is recommended for optimum and efficient operation and a long service life. It is recommended that you or a delegated employee make a daily visual check of your Tube-Ice® machine. When you are aware of the proper operating conditions and observe them on a daily basis, changes in these conditions can alert you to changes in the operation of the machine that may require maintenance long before a service situation arises.

The following schedule is suggested as a minimum:

Daily Checklist

- Is the machine running, or is the bin full?
- Bin doors are closed.
- Thermostat bulb is in the bracket.
- All ice discharges during harvest period.
- Machine and components are clean.
- No unusual noises.
- Operating pressures (suction, discharge, hot gas, oil) are within acceptable limits.
- Ice quality (clarity and uniformity) is correct (refer to water conditioning bulletin).
- Harvest period continues at least 30 seconds after the last ice is out.
- Compressor oil level is appropriate.
- Refrigerant operation level is within acceptable limits.
- The frost pattern extends from the suction outlet on the freezer to the inlet of the suction accumulator.
- Water float valve is properly adjusted (water should not pour out of the tank during operation or cause the water pump to cavitate).

Weekly Checklist

- Weekly or Monthly Calibration and operation of all controls (high- and low-pressure switches, oil pressure switch, etc.) are within limits.
- Cooling tower spray nozzles and pump suction screen are free of scaling and algae (consult water treatment suppliers for corrective measures).
- Water distributors at the top of the freezer are free of scale accumulation.
- Remove solids that have collected in the water tank.
- Check all motor drive units (compressor, pump motors, cooling tower fan, and pump, etc.) for abnormal noise and/or vibrations.
- Observe one complete ice making cycle, record data, and compare with the **Warranty Registration/Start-Up Form**.

Monthly or Yearly Checklist

- Check entire system for leaks.
- Check system for leaks after 400 hours or 4 weeks of operation.
- Drain water from the condenser and cooling tower and check condenser tubes. Inspect for damage by corrosion or scale.
- Remove all rust from all equipment, clean, and paint.
- Check all motors for shaft wear and end play.
- Check operation and general condition of all electrical controls, relays, motor starters, and solenoid valves.
- Observe one complete ice making cycle, record data, and compare with the **Warranty Registration/Start-Up Form**.
- Change oil in cutter motor gear reducer.



Warning: Pressure relief valves must be replaced after 5 years of service. Before replacing relief valves, review requirements per current local and national codes. Valve replacement should be performed only by service personnel experienced and certified in refrigeration and qualified to work with high-voltage electrical equipment. If a relief valve discharges, the valve must be replaced before putting the machine back into service. Relief valves do not properly reseal after a discharge event. Contact Vogt SuperCare Customer Service for replacement valves.

Preventive Maintenance Form

This form can be removed and duplicated for record keeping. This page is a complete Preventive Maintenance Schedule that should be performed every 90 days. The Preventive Maintenance page may be copied and given to your service person. It should be signed, dated, and returned to you for permanent record.

Date:	Model No.:	Serial No.:
--------------	-------------------	--------------------

The following service was performed and checked:

	Service
<input type="checkbox"/>	Last maintenance performed (approx. date) ____ / ____ / ____
<input type="checkbox"/>	Scale condition of water tank and tubes (good - fair - poor)
<input type="checkbox"/>	All drains freely draining (water tank, drip pan, ice bin)
<input type="checkbox"/>	Water distributors cleaned
<input type="checkbox"/>	Ice machine cleaner circulated through system
<input type="checkbox"/>	Condenser clean (water-cooled, if applicable)
<input type="checkbox"/>	Voltage at machine (actual reading) _____, _____, _____
<input type="checkbox"/>	Compressor amps (halfway through freeze cycle) _____, _____, _____
<input type="checkbox"/>	Cutter motor amps while cutting ice _____, _____, _____
<input type="checkbox"/>	Water pump amps while pump running _____, _____, _____
<input type="checkbox"/>	AC condenser motor amps (if applicable) _____, _____, _____
<input type="checkbox"/>	Crankcase heater heats oil
<input type="checkbox"/>	Refrigerant leaks (okay - high - low)
<input type="checkbox"/>	Leak-checked entire system; number of leaks found _____
<input type="checkbox"/>	Compressor oil level in sight glass (1/4 - 1/2 - 3/4 - low - high)
<input type="checkbox"/>	Gear reducer oil level (correct level - low level)
<input type="checkbox"/>	Low-pressure switch setting, psig _____
<input type="checkbox"/>	High-pressure switch setting, psig _____
<input type="checkbox"/>	Bin stat(s) installed and operating properly
<input type="checkbox"/>	Makeup water float valve adjusted properly (pump not cavitating, water tank not overflowing)
<input type="checkbox"/>	Adjustable blowdown adjusted for clear ice
<input type="checkbox"/>	Suction psig at end of freeze CYL _____ CRU _____
<input type="checkbox"/>	Suction psig during harvest (high / low) CYL _____ CRU _____
<input type="checkbox"/>	Discharge psig at end of freeze CYL _____ CRU _____
<input type="checkbox"/>	Ambient temperature at machine (°F/ °C)
<input type="checkbox"/>	Outside ambient temperature (at air-cooled condenser or cooling tower, °F/ °C)
<input type="checkbox"/>	Makeup water temperature (°F/ °C)
<input type="checkbox"/>	Freeze period time (minutes)
<input type="checkbox"/>	Harvest period time (minutes)
<input type="checkbox"/>	Total cycle time (Freeze period time + harvest period time, minutes)
<input type="checkbox"/>	First ice out time (seconds)
<input type="checkbox"/>	Last ice out time (seconds)
<input type="checkbox"/>	Ice weight per cycle (lb/ kg)
<input type="checkbox"/>	24-hour production capacity ($\frac{\text{Ice weight per cycle}}{\text{Total cycle time}} \times 1440$)

Comments:

Signature:

Chapter 8 Troubleshooting



Warning: Only service personnel experienced and certified in refrigeration and qualified to work with high-voltage electrical equipment should be allowed to install or work on this Tube-Ice® machine.



Follow all lock-out and tag-out procedures before servicing any electrical equipment.

Note: With the exception of bin control, anytime the machine stops, it must be manually restarted by pushing the **Start** button. If the machine stops during a freeze period, it restarts in a thawing (harvest) period.

This section lists potential problems and suggests solutions for this Tube-Ice® machine. Some of the problems and solutions apply to optional equipment supplied by others and may vary. Many problems are easy to solve if you know what caused them. If your problem is not covered in this section, call the factory directly at 1-502-635-3000 or 1-800-853-8648.

Your machine's electrical system has several built-in safety and overload protection features to stop operation when a single component fails or there is a problem from an outside source, such as a power supply. Make sure all auxiliary equipment is connected to safety and overload circuits so all related equipment is protected.

Always check the machine thoroughly after addressing the problem to prevent the same cause from reoccurring.

Machine Not Running

Possible Causes	Possible Solutions
Power failure and intermittent power interruption	Check electrical fused disconnect or circuit breaker supplying power to the machine. If power has been off for a period of time, make sure the compressor crankcase heater is energized, the crankcase is warm (100 - 110°F [38 - 43°C]), and there is no liquid refrigerant in the crankcase before running the machine. Push the Start touch screen button to initiate startup in a thawing period.
3.0-amp circuit breaker in the control panel trips	Check compressor crankcase heater, coils of relays, contactors, starters, solenoid valves, and thawing timer for a ground. Repair or replace any defective part and replace fuse. Make sure there is no liquid refrigerant in the compressor crankcase before restarting the machine.
High/low safety pressure switch trips	If the machine stops because the pressure is too low, the switch resets automatically when the pressure increases to the appropriate setting. If the machine stops because the pressure is too high, the switch automatically resets after the pressure drops below the appropriate setting. Check switch settings. Push the Start touch screen button to start the machine in a thawing period. Check the head pressure during the next freeze period. Refer to Chapter 9, (High/Low Pressure Switch).
Differential oil pressure safety trips	If the machine stops because the differential oil pressure is too low, check the safety on the compressor. A solid red light comes on if tripped. To reset the sensor, press the Reset button. The switch can only be reset after a 100 second delay after shutting off. The oil level should be 1/4 – 3/4 in the sight glass. Add oil if necessary.

Machine Not Running, cont.

Possible Causes	Possible Solutions
Cutter motor overload trips	Check and clear the cutter area and ice discharge path of all ice. Check voltage and overload range adjustment against motor rating. Reset the manual motor starter, reset the fault on the touch screen and restart the machine by pushing the Start touch screen button. Check the cutter operation and motor amp draw. If tripping repeats, but there is no ice clogging the cutter area or ice discharge path, check the cutter bearing for wear, the gear reducer for resistance, and the motor for defects or single phasing.
Pump motor overload trips	Check voltage and overload range adjustment against motor rating. Reset the manual motor starter, reset the fault on the touch screen, press the Run Water Pump touch screen button. Check the pump operation and motor amps. If tripping repeats, check for a defective overload, defective motor, or single phasing.
Bin thermostat or bin level control stops machine	Adjust or replace the bin thermostat or level control. Make sure the bin thermostat bulb or level control is located properly in the bin. Refer to <i>Ice Bin Thermostat Sensor</i> .
Defective component in control panel	Check for open circuit. Refer to Figure 13 to identify parts. Replace defective part, restart machine, and check power supply and current draw.

Freeze-Up from Extended Freeze Period

Possible Causes	Possible Solutions
Freezer pressure switch setting too low	Adjust freezer pressure switch or replace if defective.
Water tank drain valve or makeup water solenoid open too long	Close, repair, or replace valve as needed.
Thaw gas solenoid valve leaking during the freeze period	Check the manual opening stem to make sure it is in the automatic position (stem screwed out). Check for leakage through the valve by measuring the sound and temperature differences. Close the stop valve at the receiver to confirm leakage. Repair or replace the valve as needed.
Float switch sticks or fails to close	Check to make sure the float switch is opening and closing.
Liquid line solenoid valve (A) is stuck open	Check to make sure the valve is not in the manual open position. Disassemble valve and inspect for debris. Clean valve if required.

Freeze-Up from Ice Failing to Discharge

Possible Causes	Possible Solutions
Insufficient heat for thawing because of low condensing pressure, non-condensable gases (usually air) in system, low refrigerant charge, or thaw gas pressure switch adjusted too low	The head pressure should be maintained at approximately 145 psig (10 bar) for R-513A, which relates to 105.8°F (41.0°C) by adjusting the water regulating valve (water-cooled units) or fan cycling switch (air-cooled units). If non-condensable gases are present in the refrigerant, the saturated temperature will not relate to the pressure reading at the receiver. The refrigerant level in the receiver should be near the operating level (marked by the sticker) at the end of a freezing period to provide enough volume for harvesting. (1-in. [2.54 cm] = approx. 10 lb. [4.5 kg] of R-513A).
Thawing time too short	Check the Harvest Timer which should be changed to allow all the ice to clear the cutter and ice discharge opening with at least 30 seconds to spare.
Cutter or cutter disc does not turn	Check cutter reducer and drive gear for proper operation and alignment. Check for broken cutter disc or drive pin and replace as necessary.
Ice backs up into cutter or discharge opening, jamming cutter	Ice mushy due to concentration of solids in the water tank. Perform "Cleaning Procedure" and check automatic and adjustable blowdown. If the machine discharges ice into a chute, it should slope at an angle of 30 degrees for cylinder ice, and 45 degrees for crushed ice. Check bin stat or level control to make sure it will stop the machine before ice backs up into the cutter.
Extended freeze period	Check the Freezer Pressure Switch or Freeze Timer , refer to Chapter 9, (Freezer Pressure Switch on Touch Screen HMI) and Error! Reference source not found. Normal Operating Criteria.
Compressor not unloading	Check compressor amps during harvest. A noticeable drop in amperage should occur. Check unloader solenoid coil. If coil is okay, replace unloader head assembly.
Thawing time too short	Check the Harvest Timer , which should be adjusted to allow all the ice to clear the cutter and ice discharge opening with at least 30 seconds to spare.

Poor Ice Quality

Possible Causes	Possible Solutions
Excessive concentration of solids in the water tank, indicated by a build-up of mineral deposit on the sides and bottom of the tank	Clean the water tank. Remove the freezer cover and clean the water distributors. Adjust continuous blowdown.
Insufficient water supply indicated by a low level in the tank	Check water pressure—30 psig [2 bar] is the recommended minimum. Check for a water line restriction, partially closed valve, or defective makeup water float valve. Make sure the water tank drain valve is closed.
Water pump rotation wrong direction	Check rotation by referring to the arrow on the pump housing and reverse two wires at the motor if necessary.
Low refrigerant charge	Check refrigerant level mark on the receiver and on the red portion of the gauge glass guard. Perform a pumpdown if necessary. Keep the gauge glass cocks closed when finished checking the level.
Insufficient blowdown during harvest	Check for proper operation of the siphon vacuum break valve. Check for restrictions or traps in the water tank drain assembly.

Low Ice Capacity

Possible Causes	Possible Solutions
Low refrigerant charge	Check for and repair leaks. Add refrigerant.
Restriction in liquid line	Check for a partially closed valve or an obstruction at the dryer, strainer, solenoid valve, or expansion valve. The liquid line will normally have frost on the downstream side of a restriction, especially as the suction pressure decreases.
Float switch stuck or failed in open position	Make sure the float switch is opening and closing. Make sure the A valve is getting power.
Thaw gas solenoid valve leaking during the freeze period	Check the manual opening stem to make sure it is in the automatic position (stem screwed out). Check for leakage through the valve by measuring sound and temperature differences. Close the stop valve at the receiver to confirm suspicion of leakage. Repair or replace the valve as needed.
Water distributors at top of freezer are clogged	Remove freezer cover and clean the distributors. Refer to <i>Water Distributors</i> in Chapter 7.
Not enough water for ice making	Check water pressure (30 psig [2 bar] minimum is recommended). Check for a water restriction in the supply line or at the makeup water float valve.
Makeup water float valve stuck open, adjusted too high, or water tank drain valve open or leaking	Repair, replace, or adjust float valve as needed. Close, repair, or replace water tank drain valve as needed.

Low Ice Capacity, cont.

Possible Causes	Possible Solutions
Controls for regulating freezing and thawing periods not adjusted properly	For highest capacity, cylinder ice should have a small hole and crushed ice should be about 3/16-in. [4.8-mm] thick. Adjust the Freezer Pressure Switch or Freeze Timer and Harvest Timer as needed. Refer to Chapter 9
Excessively high head pressure	Check water regulating valve or fan control adjustment. Clean the condenser if needed. Check refrigerant table for appropriate pressures and temperatures.
Warm makeup water for ice making	Capacity of the machine is proportional to the water temperature during ice making. Warmer water will reduce the ice-making capacity.
Drain valve open	Close drain valve.
Low refrigerant charge	Check for and repair leaks. Add refrigerant as needed.
Restriction in liquid line	Check for a partially closed valve, or for an obstruction at the dryer, strainer, solenoid valve, or expansion valve. The liquid line will normally have frost on the downstream side of a restriction, especially as the suction pressure decreases.

High Head Pressure (Water-Cooled Machines)

Possible Causes	Possible Solutions
Misadjusted or defective water regulating valve	Adjust or replace valve. Never adjust the valve stem as far open as it will turn, because it will not close when the head pressure drops.
Insufficient water supply	Check size of water line and pump output at the condenser. Refer to the specification sheet for water requirements. Check cooling tower sump level and makeup water supply.
Cooling tower needs maintenance	Check cooling tower fan belt and tighten or replace as needed. Check spray nozzles and sump screen and clean as needed.
Non-condensable gas (usually air) in system	Check refrigerant tables for appropriate pressures and temperatures. If non-condensable gases are present, perform a total pumpdown. Let stand for at least 6 hours, allowing non-condensable gases to collect in the upper part of the receiver. Evacuate the freezer and attach a recovery unit to the top receiver purge valve. Open the valve and recover the vapor for about five minutes. When the freezer is evacuated, open the thaw gas solenoid valve (D) manually for about 15 seconds, letting the top vapor in the receiver blow into the freezer. Close the solenoid valve and evacuate the freezer again. Evacuate to 500 microns and restart the machine.
Fouled (dirty) condenser	Visually inspect condenser and clean as necessary.
Misadjusted or defective water regulating valve	Adjust or replace the valve. Never adjust the valve stem as far open as it will turn, because it will not close when the head pressure drops.

Chapter 9 Servicing Operations

Automatic Blowdown

The automatic blowdown or harvest period eliminates or reduces the need for frequent flushing or cleaning of the water tank. This blowdown also removes accumulated salts or solids in the water as a result of the freezing action. During the harvest period, water returning from the freezer raises the tank level and causes an overflow of water. The overflow creates a siphon to remove a fixed amount of water (20% of tank capacity) from the tank.

Makeup Water Float Valve

The makeup water float valve maintains the proper pumping water level for ice making. The valve is set to maintain an appropriate level (high enough to prevent pump cavitation and low enough to prevent tank flooding) in the water tank during the freezing period so there will be a quantity of bypass or blowdown only during the thaw mode. The water level during the freeze mode must always be below the bypass piping to prevent excessive waste of cold water; otherwise, loss of ice capacity results.

If cleaning the float valve is required, close the stop valve in the makeup water line to the machine and remove the float valve. After the valve is cleaned and reinstalled, ensure the proper water level is being maintained. After the machine stops, and the water in the tank reaches its normal level, there should be no water flow through the float valve or drain bypass.

Installation of a 40-mesh strainer in the water supply line is recommended. The strainer protects the float valve from dirt or solids in the water and helps reduce the amount of cleaning.

Hand Expansion Valve

The hand expansion valve is located after the liquid line solenoid valve (A). This should be set at a point where the float switch is open for a length of time approximately equal to the time it is closed. The factory setting is about three turns closed from full open.

Freezer Pressure Switch on Touch Screen HMI

The **Freezer Pressure Switch** controls the freezing time period for the production of cylinder or crushed ice. It is adjusted on the **Quick Setup** screen when viewing the **Home** screen on the HMI.

This setpoint is selected at the factory to produce ice of recommended thickness. Refer to the Certificate of Test, which was provided with the machine for a sample set of pressure readings with corresponding time periods and water temperatures. Do not make adjustments until several ice discharging cycles have been completed.

Freeze Timer on Touch Screen HMI

The **Freeze Timer** controls the freezing time period for the production of cylinder or crushed ice. It is adjusted on the **Setup** screen when viewing the **Home** screen on the HMI.

This setpoint is selected on site to produce ice of recommended thickness. Do not make adjustments until several ice discharging cycles have been completed.

Low Pressure Safety on Touch Screen HMI

The **Low Pressure Safety** will shut the ice machine off if the compressor suction pressure drops below the setpoint. The factory setpoint for the low-pressure safety is 4 psig (0.27 bar). The setpoint where the machine can restart is 20 psig (1.4 bar).

High Pressure Safety on Touch Screen HMI

The **High Pressure Safety** will shut the ice machine off if the compressor discharge pressure reaches the setpoint. The factory setpoint for the maximum safe pressure is 200 psig (13.8 bar). The setpoint where the machine can restart is 145 psig (10 bar).

Head Pressure Control

For R-513A, the head pressure should be maintained at 145–155 psig (10–10.6 bar) during the freeze cycle. This pressure can be checked at the compressor discharge valve. It is also displayed on the **Home** screen of the HMI.

Control Circuit Protection

The electrical control circuit of the machine is protected by a 2-pole, 3A circuit breaker. If the breaker opens, the machine stops immediately. Before opening the panel to reset the breaker, open the disconnect switch to the machine first.

When power is restored to the machine, follow the prompts on the HMI to restart the machine.

Harvest Timer

The **Harvest Timer** governs the length of the ice thawing period.

The **Harvest Timer** is set from the factory for a time that is at least 30 seconds longer than the time required to harvest the entire discharge of ice. Should it become necessary to change the duration of a thawing period, the **Harvest Timer** can be adjusted through the **Quick Setup** submenu from the **Home Screen** of the HMI. After adjustment, verify the new setting is at least 30 seconds longer than the time required for the last piece of ice to be discharged from the machine.

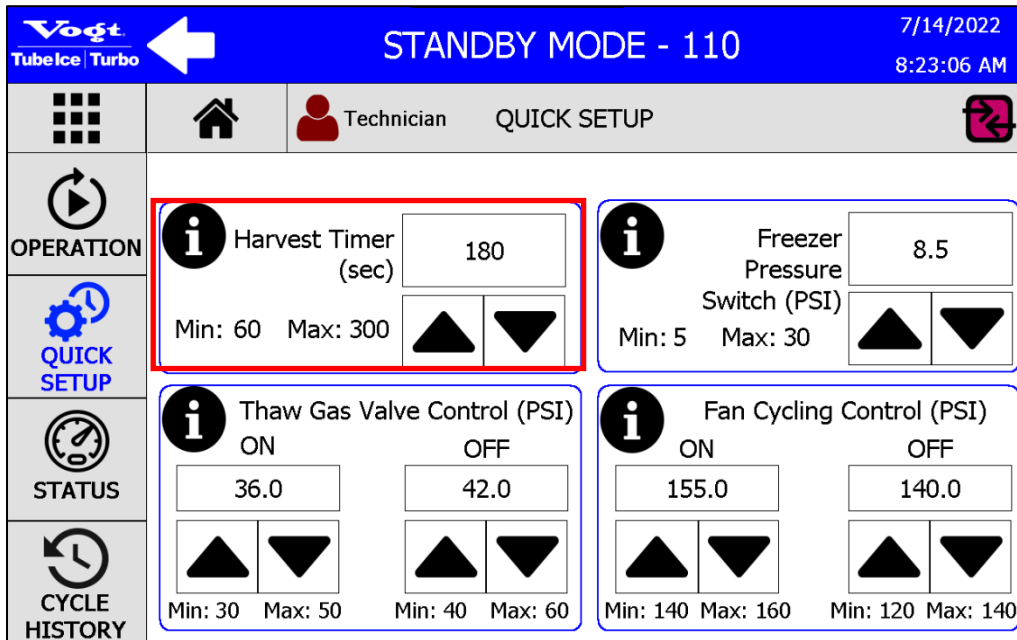

Figure 68: Harvest Timer

Pumpdown

The pumpdown function transfers all the liquid refrigerant from the freezer (evaporator) into the receiver. This function is only performed when the freezer is clear of ice and before or during the following operations:

- Checking the total refrigerant charge
- Performing service or repair work on the machine
- Winterizing the machine
- Preparing the machine for disconnecting and moving
- Before cleaning

To perform a pumpdown, follow these steps:

1. Close the liquid stop valve (king valve) at the receiver during a freeze cycle.
2. Allow the machine to enter into a thawing cycle and empty the freezer of all ice.
3. While in the harvest, open the water tank drain valve partially to allow a continuous flow of warm makeup water into the tank while still maintaining the appropriate water level. An auxiliary supply of warm water (not to exceed 100°F [38°C]) may be used if available.
4. On the touch screen HMI, access the **Troubleshooting** menu from the **Menu** screen.



Figure 69: Troubleshooting Icon

5. When the machine begins to enter the next freeze cycle, press the **Pumpdown Mode** touch screen button in the **Troubleshooting** menu.

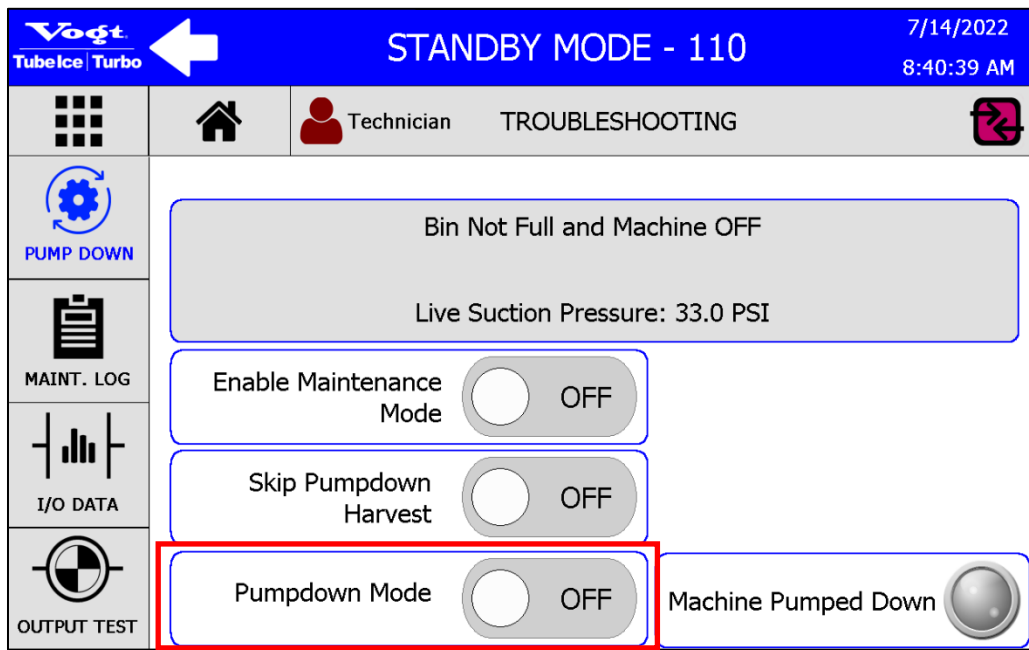

Figure 70: Pumpdown Mode Touch Screen Button

6. Allow the machine to operate until the **Freezer Pressure Switch** reaches the normal setpoint and enters a 60 second **Pumpdown Harvest**.
7. After completion of the **Pumpdown Harvest**, the machine will operate until it reaches 3 psi. The machine will shut off.
8. Close the thawing gas stop valve, the receiver liquid return stop valve, the compressor suction valve, and the compressor discharge valve.

Refrigerant Leaks

It is recommended to complete a leak test after the unit has been in operation for approximately one week. Any noticeable change in operating conditions, other than shown on the Certificate of Test, may indicate a loss of refrigerant due to a leak. Always completely evacuate and recover the refrigerant from the vessel or tubing before repairs are attempted.

Non-Condensable Gases

Air and other non-condensable gases in a refrigeration system are not desirable and can cause unsatisfactory machine performance. Non-condensable gas effects are:

- Higher condensing pressure than what should match the condensed liquid temperature according to a pressure-temperature chart
- Greater electrical power consumption
- Reduced refrigeration capacity
- Longer than normal compressor running time
- Slow ice release
- Long thaw cycle

Air collects mostly in high-pressure condensers, receivers, and other high-pressure components. It is most commonly found in the coolest, lowest-velocity area of these components.

Evaporative condensers usually have purge points at the top of the outlet header of each circuit. Receivers usually have a purge point at the top, away from the inlet, where it is coolest, and the gas velocity is the lowest.

Excessive condensing pressure in water-cooled condensers may also be due to:

- Accumulation of scale in the cooling coil
- Insufficient cooling water
- Excessive water temperature

Valve Stations

The P34HL is supplied with valve stations that provide all valve functions in a single unit rather than a train of independent valves. This minimizes the number of connections required for each refrigerant line on the machine, reducing the potential for leaks in service. Additionally, all valve stations are constructed of stainless steel and plated components to reduce corrosion. All shut-off, expansion, regulating, and solenoid functions are contained within the single body and are top mounted for ease of service with standard tools. See Figure 71.

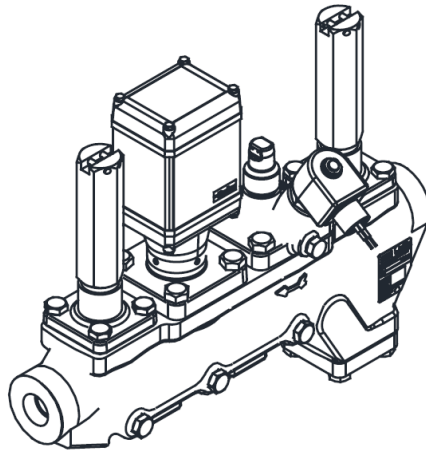

Figure 71: Typical Valve Station

Should a module need to be removed for servicing, simply close the shut-off valves at each end and evacuate the refrigerant charge in the body through the supplied access fittings. Rebuild kits are available through the factory.

Capacitive Level Control

The liquid level in the freezer is controlled by a Hansen Vari-Level® system that consists of a capacitive probe that sends a digital signal to a control unit. The control unit is the operator interface that contains the digital readout of the liquid level in the freezer along with knobs and dials for adjusting the liquid level. Typical settings are shown below for this machine, but field adjustments will be required to optimize ice production at individual installations.

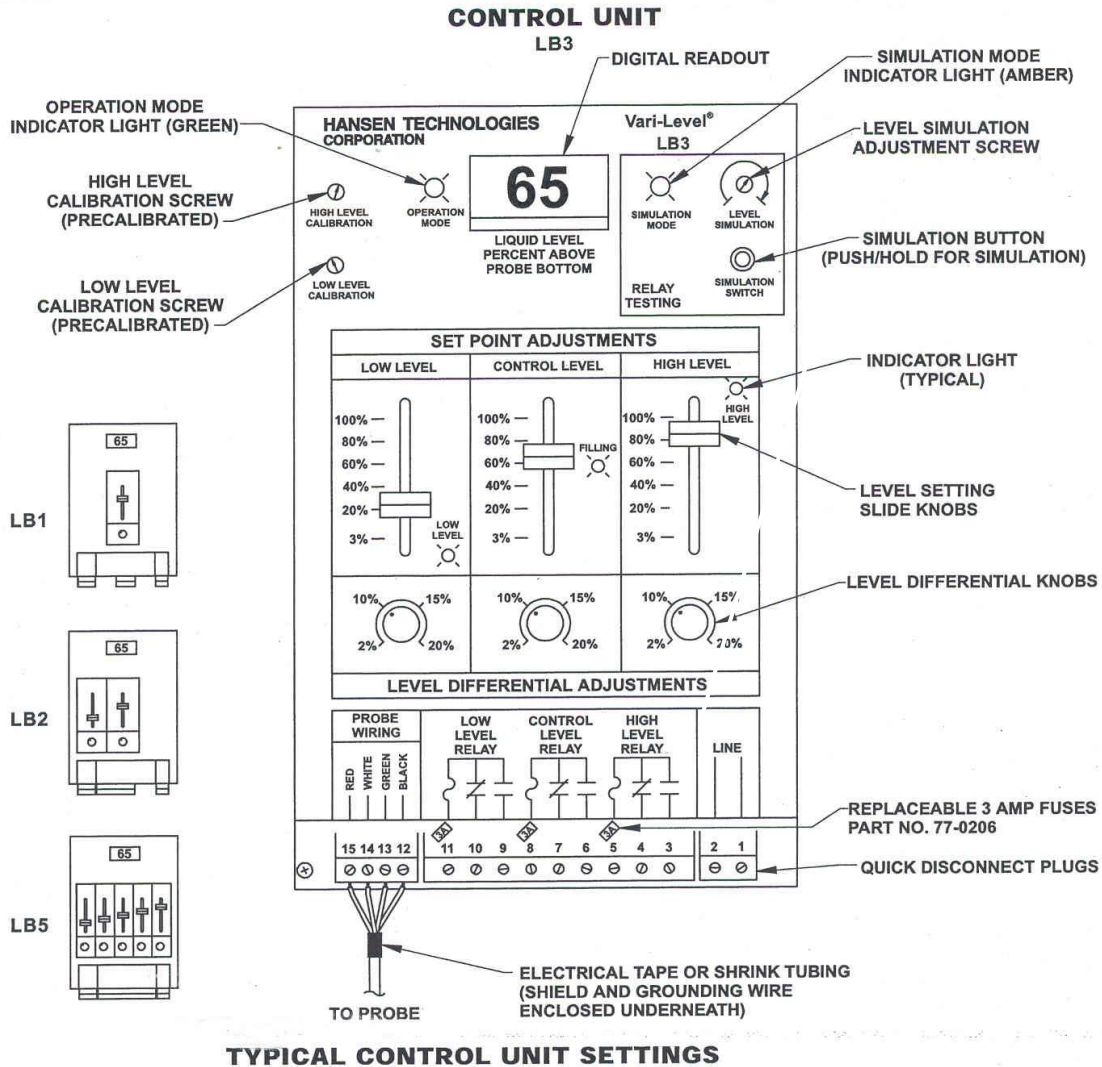

Figure 72: Hansen Vari-Level® Control Board Layout

Table 8: Set Point Adjustments for the Hansen Vari-Level®

	Differential	Set Point
High Level	2%	70%
Control Level	2%	20% - 40%
Low Level	Not Used	Not Used

Consult the electrical wiring diagram supplied with the machine for additional detail on how the Hansen Vari-Level® system is integrated with the ice machine.

Prior to connecting electrical power, check the voltage on the control unit nameplate and the power supply at the wire leads to ensure that they are identical. The supply voltage must not be more than 10% above nor 15% below the listed voltage. Connect the power supply leads to the quick disconnect plug (Terminals 1 and 2) and secure into the appropriate marked socket.

The liquid level probe is the device that is mounted in the level column of the freezer to measure the liquid level. The level is determined when the probe sends a small, specialized signal out into the refrigerant liquid / vapor mixture, and compares it with the strength of the return signal. The housing above the probe contains the electronics to send and to receive the signal from the probe, and to send that information continuously to the control unit mounted on the side of the ice maker frame.

When installing the probe, match its serial number with the control unit. The probe and the control unit are individually calibrated to one another to ensure proper operation.

Remove the probe from the packing crate, exercising caution not to bend or to whip the probe. Use non-electrically isolating pipe thread sealant (**DO NOT USE TEFLON® TAPE**) on the ¼" MPT fitting on the probe and insert it into the top of the level column. Tighten the probe on the provided hexagonal nut – **do not grip the probe housing flats or the electrical box**. Pressure test for leaks.

Probes are supplied from the factory with 50 ft (15.2 m) of shielded control cable. If the control unit is located less than 50 ft (15.2 m), trim the control unit end of the cable as necessary. Securely place the control cable quick disconnect plug into the appropriate marked socket inside of the control unit.

Set Point and Operation

The set point adjustment controls are a series of slide knobs with scales showing the percentage of active probe length with a minimum setting of 3% and a maximum setting of 100%. The bottom end of the probe is the minimum level reference point.

The level differential adjustment controls are a set of dial knobs with scales showing the percentage of active probe length with a minimum setting of 2% and a maximum setting of 20%. This is the number of percentage points above or below the set point to which the unit will attempt to control.

For example, if the Control Level is set to 30% with a Level Differential of 2%, the Vari-Level® controller will attempt to maintain a liquid level in the freezer of 30% with a variance of 2% by opening and closing the liquid feed solenoid valve. Note that the digital readout will often show values much higher or lower than the set point; however, the liquid feed solenoid valve in this example will close when the level is at or above 30%, and will open at or below 28%.

Low Level Adjustment

Not used on the P34HL.

Control Level Adjustment

This set point is intended to maintain the level inside of the freezer through the liquid feed solenoid valve. The control level set point is the level at which the make-up liquid will start to feed into the vessel. The level in the freezer should be set between 20% and 40% and dependent on make-up water and ambient temperatures. The differential adjustment control knob should be set at 2%. The liquid feed indicator light will be on when the relay is energized.

High Level Adjustment

This set point signals that the liquid level is becoming too high in the freezer. The high level set point is the highest level that the liquid should ever reach before a compressor cutout occurs. This should be set at 70% with the differential adjustment control knob set at 2%. The high level indicator light will be on when the relay is de-energized.

Simulation

The purpose of the built in simulator is to enable the level set points and differentials to be set accurately and to be checked for proper system operation.

CAUTION

Control devices such as solenoid valves, contactors, and compressors (etc.) can operate while in the simulation mode. For calibration and electrical checkout, disconnect the main circuits of the compressor motor, pump motor, etc., where necessary to prevent damage, or remove the relay quick disconnect plug in the control unit.

To enter the simulation mode, press and hold the simulation button. The amber simulation mode light will turn on. When in simulation mode, the digital readout displays the simulated liquid level rather than the actual liquid level in the freezer.

While continuing to hold the simulation button, use a small screwdriver to rotate the level simulation adjustment screw to change the simulated liquid level (and display value). Observe the operation of the indicator lights. If necessary, make adjustments to the values of the level set point and differential knobs.

When the relay level set points and differentials are properly set, return the simulated level to a percentage value between the control level and high level settings. This prevents unexpected operation of the relays during the next simulation.

Release the simulation button to return to normal operation. The value displayed on the readout now shows the actual liquid level in the freezer and the relays will respond accordingly.

Recalibration

Control units are factory calibrated to a 3" diameter level column for the specified refrigerant and the exact probe supplied. Recalibration may become necessary when a replacement probe or control unit is installed, particularly if the replacement equipment is not factory matched by serial number.

When replacing a probe or control unit, the 0% level point and at the 50% level point should be checked at the operating refrigerant temperature for accuracy. The installer maintains responsibility to ensure proper calibration for the specific application. If the control unit appears to be out of calibration, check for possible causes in the troubleshooting guide before attempting to change the calibration settings.

To recalibrate the unit at the 0% and 50% level point on the freezer, follow the procedure below:

- Begin by performing a pumpdown on the freezer to remove liquid from the vessel. This ensures an appropriate setting for the 0% level point.
- With the freezer pumped down, the digital readout on the control unit should display -00%. Remove the seal on the low level calibration screw and adjust with a small screwdriver until the digital readout displays the correct value. After adjustment, replace the seal.
- Begin to feed liquid into the freezer until the level is centered in the sight glass on the level column where the probe is inserted. This is the 50% level of the freezer and the digital readout on the control unit should display a matching value. Remove the seal on the high level calibration screw and adjust with a small screwdriver until the digital readout displays the correct value. After adjustment, replace the seal.
- For greatest accuracy, pump down the freezer again and confirm that the digital readout displays a value of -00%. Adjust the low level calibration screw again, if required, and replace the seal.

A troubleshooting guide for the Hansen Vari-Level® system is provided below.

Table 9: Troubleshooting Guide for the Hansen Vari-Level® Controller

Problem	Cause	Action
Digital readout and indicator lights do not display	No power to control unit or wrong voltage	Check voltage at terminals 1 and 2 in the control unit
	Moisture in control unit or probe housing	See Note 1 below
Digital readout does not indicate level changes	Fault in control cable	See Note 2 below
	No continuity between probe and level column	Check for Teflon® tape or other non-conductive pipe sealant at probe to column connection; replace sealant
	Moisture in control unit or probe housing	See Note 1 below
	Probe wire loose	Open probe housing cover and check connection of probe wire (single wire lead) from probe center to terminal connection
Solenoid valve (#20A) does not respond	Blown fuse in control unit; fuses located just above quick disconnect terminal strip	Find reason for electrical fault and correct; replace blown fuses
Digital readout indicates too low of a level compared to sight glass	Control unit and probe serial numbers do not match	Contact factory if mate is not available
	Fault in control cable	See Note 2 below
	Moisture in control unit or probe housing	See Note 1 below
	Calibration not correct	See recalibration instructions
	Calibrated for different refrigerant	Contact factory for replacement
	Insulating resistance of Teflon® enclosed probe rod is too low	See Note 3 below
Digital readout indicates too high of a level compared to sight glass	Control unit and probe serial numbers do not match	Contact factory if mate is not available
	Fault in control cable	See Note 2 below
	Moisture in control unit or probe housing	See Note 1 below
	Calibration not correct	See recalibration instructions
	Calibrated for different refrigerant	Contact factory for replacement
	Oil rich mixture in level column	Check for excessive oil carryover from compressor
Intermittent high level	Rapid suction pressure pull down results in excessive boiling and liquid surging	Check time delay timer "DT" for proper operation

Problem	Cause	Action
	High level alarm point has been positioned too close to operating set point	Lower operating set point or raise high level set point
	Moisture in control unit or probe housing	See Note 1 below
Occasional erratic level displayed on digital readout without actual changes in level.	Moisture in control unit or probe housing	See Note 1 below
	Radio Frequency Interference (RFI)	Find source of interference, such as mobile radios or transmitters, and disable. If unable, contact factory for arrestor device.

Note 1 – MOISTURE IN CONTROL UNIT OR PROBE HOUSING. Dry out control unit or probe housing. If appearance is dry, look for signs of moisture damage, such as white residue. Check cover gaskets, watertight cable connectors, and other water sealing joints; replace if worn. If a conduit connection is on top of the probe, carefully seal the inside to prevent condensation migration into the housing. Relocate any conduit connections on top of the control unit to the bottom, or seal the connections.

Note 2 – FAULT IN CONTROL CABLE. A symptom can be the digital readout display above 100% or below 0%. Check wires and matching color dots on quick disconnect plugs at the probe and control unit for proper connection. See probe wiring diagram. Wires should be securely fastened and not frayed. Check for continuity in the wiring.

Note 3 – INSULATION VALUE OF PROBE. The following procedure is only required if probe integrity is questioned. With the probe wire removed from its socket, check the insulating resistance of the Teflon®-enclosed probe rod using a 500V “Megger.” Connect the positive side to the probe wire, the negative side to the probe housing. The result should be over 1000 Mega Ohms; halocarbon probes should be over 50 Mega Ohms. If not, contact factory.

Circulating Water Pump Motor

The motor bearings are pre-lubricated and sealed. They require no further lubrication. The pump should operate with the water level above the impeller housing. The pump also has a mechanical seal that requires no lubrication and is self-adjusting. However, the pump should not be operated unless it is circulating water. The pump manufacturer recommends that a mechanical seal be kept as a spare. When ordering a seal, specify pump size, type, serial number, and manufacturer’s name as indicated on the nameplate.

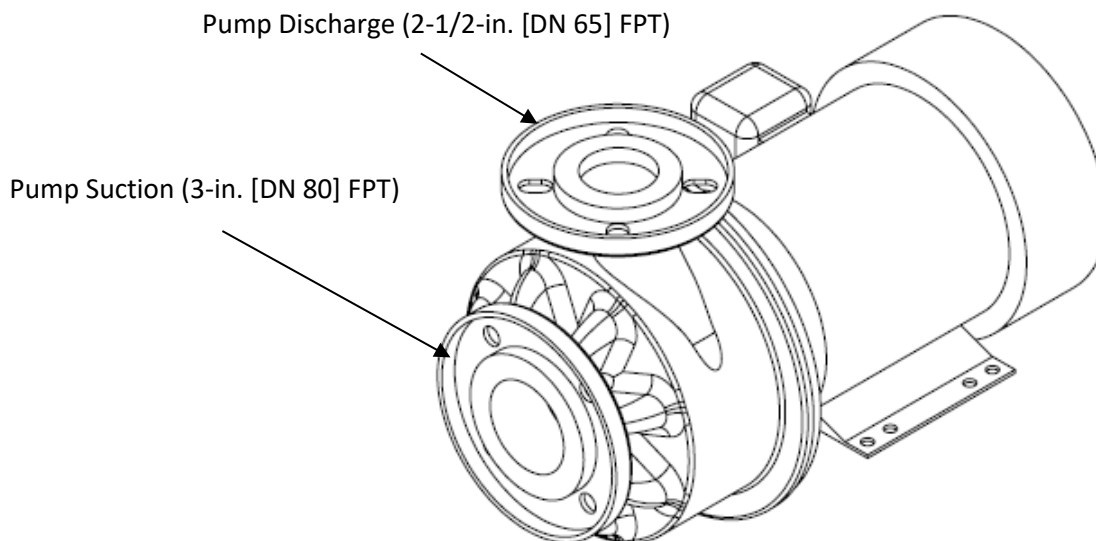

Figure 73: Circulating Water Pump

Cutter Gear Reducer

The cutter motor and gear reducer drive the ring gear of the cutter assembly. The teeth of the drive gear and the ring gear must mesh properly in both the vertical and horizontal planes. The drive gear and hub can be raised or lowered on the gear reducer shaft to obtain the proper tooth depth for maximum gear life.

The motor and gear reducer are an integral unit. Only qualified personnel should attempt to disassemble and repair the unit.

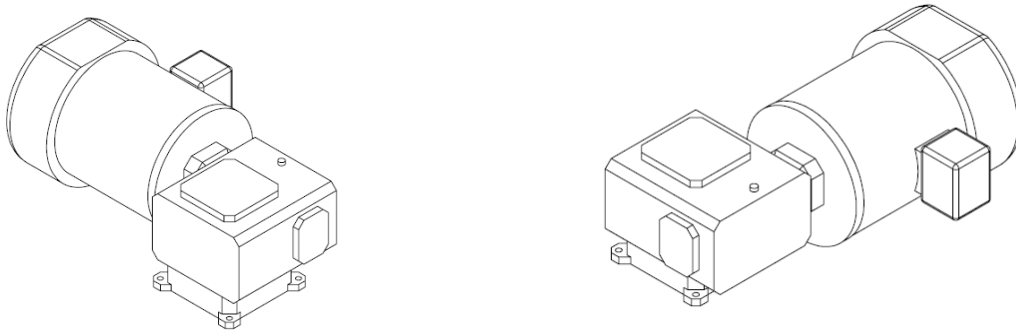

Figure 74: Cutter Motor and Gear Reducer

Cutter Motor Replacement

The cutter motor bearings are pre-lubricated and sealed, requiring no further lubrication or maintenance. If the motor requires replacement, follow the steps below:

1. Turn the power off and lock out the disconnect.
2. Check terminals with voltmeter to confirm the power is off.
3. Remove motor terminal cover and disconnect wires. Mark wires for ease of replacement.
4. Remove four cap screws around the motor flange and separate the motor from the reducer. Watch for shaft key that must be reinstalled later. Replacement motor does not come with a new key.
5. Check the motor electrically for shorts to confirm that it is defective.
6. Apply anti-seize lubricant to the shaft of the replacement motor.
7. Position the shaft key in the motor keyway, align it with the reducer keyway, and install the motor. Make sure that the key stays in position as the shaft is inserted.
8. Install the four cap screws to hold the motor in place on the reducer.
9. Connect the wires and install the terminal cover.
10. Check motor rotation to verify that the cutter turns counterclockwise. Reverse two wires at the motor if necessary, to change rotation direction.

Drive Gear Replacement

To remove the drive gear, follow the steps below (refer to Figure 76):

1. Turn the power off and lock out the disconnect.
2. Remove the top and side bolts holding the mounting plate to the support bracket. Lift the plate and gear reducer from the bracket and rest the assembly on a stable worktop sitting next to the tank. Leave the electrical conduit connected to the gear reducer motor.
3. Inspect the drive gear teeth for proper vertical alignment and wear pattern.

4. If the wear pattern indicates less than a full width of tooth engagement, measure the difference and make a note to correct it at the time of reassembly.
5. Measure and record the dimension from the drive gear to the bottom side of the mounting plate.
6. Remove the three or four cap screws holding the drive gear to the bottom side of the mounting plate.
7. Using two of the same cap screws in the threaded holes of the bushing, jack the gear off the bushing and remove both from the gear reducer shaft.
8. Clean the split bushing and tapered hole of the new drive gear and insert the bushing into the drive gear making sure that the tapers match.
9. Slide the split hub and gear onto the keyed shaft with the key in place, positioning the hub (by the measurement previously recorded) so that the full width of the gear teeth will engage when assembled and tightened.
10. Tighten the cap screws progressively and uniformly around the hub and recheck the location measurement. If it is not correct, loosen the cap screws, hub, and gear assembly, and correct. Then re-tighten the cap screws.
11. Install the reducer and mounting plate assembly on the water tank bracket and fasten in place with the side and top cap screws.
12. Rotate the cutter disc assembly by hand and stop at the point where the least amount of backlash is felt between the gear teeth.

Note: Only a slight amount of backlash should exist, sometimes referred to as “tooth tip clearance.” Too much clearance will cause premature wear and possible tooth damage. When the cutter runs under a no-load condition, the sound should be uniform. Refer to the chapter on maintenance for lubrication.

13. If the backlash or “tooth tip clearance” needs adjusting, loosen the four hex nuts holding the reducer to the mounting plate and move the reducer as required for proper tooth engagement. Tighten the hex nuts securely and recheck backlash.

Gear Reducer Replacement

To remove the gear reducer, follow the steps below (refer to Figure 76):

1. Turn off and lock out power to the machine.
2. Disconnect electrical wires and conduit from the motor.
3. Remove the top and side bolts holding the mounting plate to the support bracket and lift the plate and gear reducer assembly from the tank bracket.
4. Inspect the drive gear teeth for proper vertical alignment and wear pattern. If the wear pattern indicates less than a full width of tooth engagement, measure the distance so that correction can be made at the time of reassembly.
5. Measure and record either the distance of the drive gear from the mounting plate or the split hub from the shaft end for future reference when reassembling.
6. Remove the three or four cap screws from the split taper bushing.
7. Use two of the cap screws in the threaded holes of the bushing and jack screws for pushing the drive gear from the hub.
8. Drive a wedge into the split of the hub (bushing) and slide both the hub and the gear from the shaft.
9. Remove the four hex nuts and lock washers from the carriage bolts around the reducer base and mounting plate and separate the plate and the reducer.
10. Install the replacement gear reducer and motor onto the mounting plate using the carriage bolts, lock washers, and hex nuts. Hand tighten the nuts for later adjustment.
11. Clean the split hub and drive gear and insert the hub into the gear, making sure that the tapers of the two match. Slide the hub and gear onto the shaft.
12. Position the hub on the shaft (note measurements previously taken) so that the full width of the gear teeth will engage when assembled and tightened.

13. Tighten the cap screws progressively and uniformly around the hub, check the measurements and adjusting as necessary.
14. Install the reducer and mounting plate assembly on the water tank bracket and fasten in plate with the side and top cap screws.
15. Rotate the cutter and disc assembly by hand and stop at the point where the least amount of backlash is felt between the gear teeth.
16. If the backlash or “tooth tip clearance” needs adjusting, loosen the four hex nuts around the reducer base and move the reducer as required for proper tooth clearance. Tighten the hex nuts securely and recheck for backlash.
17. Reconnect the electrical wires and conduit to the motor.
18. Check cutter rotation and correct as necessary.

Note: Only a slight amount of backlash should exist, sometimes referred to as “tooth tip clearance.” Too much clearance will cause premature wear and possible tooth damage. When the cutter runs under a no-load condition, the sound should be uniform. Refer to the chapter on maintenance for lubrication.

The weights listed below are provided for the purposes of manpower and equipment planning when this service is required. Practice safe lifting and handling practices to prevent bodily injury and/or damage to parts. Contact the factory or your distributor if additional information is required.

Table 10: Water Tank and Cutter Part Weights

Part Description	Weight, lb (kg)
Water tank (bare without cutter assembly)	428 (219)
Water tank (with cutter assembly)	742 (337)
Bearing bracket assembly and cutter disc	150 (68)
Cutter assembly and ring gear	164 (74)
Cutter disc	97 (44)
Cutter drive gear	14 (6.5)
Gear reducer and motor	96 (44)
Water pump	85 (39)

Water Tank Removal

To remove the water tank from the machine, follow the steps below:

1. Turn off and lock out power to the machine.
2. The machine is designed with ample space to roll the water tank out from under the machine. Check that no obstructions exist that would prevent the tank from rolling when removed. A sheet of plywood or other flat level surface with sufficient support for the weight of the complete tank assembly may need to be provided to assist. Refer to the weights listed in the table above.
3. Turn off water supply, drain the water, and disconnect lines from the tank.
4. Remove the overflow tubing from the water tank and remove the circulating water tubing from the water pump.
5. Remove the bolts from the water pump suction flange. Note that the water pump is mounted to the structural frame of the ice machine and not to the water tank.
6. Disconnect the ice discharge chute or hopper from the ice discharge opening of the water tank, making sure that the tank is free to be moved.

7. Remove the mounting bolts from around the flange of the tank, allowing the tank to be lowered to rest on the casters.
8. Remove the channel support on the base of the ice machine frame, opposite from the side of the water pump. This allows the water tank to roll freely out from under the machine.
9. Roll the water tank out from under the freezer, rotating it slightly while rolling to allow the gear reducer and motor to clear the ice machine frame.

The tank is now accessible for inspection and/or repair.

Cutter Assembly Removal and Reinstallation

Follow the steps below. Refer to Figure 76.

1. Turn off the power and lock out the disconnect.
2. Follow the instructions for removal of the water tank, above.
3. Remove the socket head cap screw from the center of the cutter shaft and lift out the retainer and gasket.
4. Lift the cutter straight up and off the shaft, taking care to catch the shaft key as it is removed.
5. To install the cutter, lower it down onto the shaft, allowing the ring gear to mesh with the drive gear.
6. Rotate the cutter, aligning the shaft and the hub keyway and inserting the key to its full depth.
7. Install the gasket, the retainer, and the socket head cap screw and tighten to 15 ft-lb (20 N-m).
8. Check and adjust the cutter height according to the Cutter Height Adjustment instructions, below.

Bearing Bracket and Cutter Disc Removal

Follow the steps below. Refer to Figure 76.

1. Turn off the power and lock out the disconnect.
2. Follow the instructions for removal of the water tank, above.
3. Follow the instructions for removal of the cutter assembly, above.
4. Match mark the bearing bracket support arms with the water tank for reassembly reference.
5. Remove the splash shield and ice deflector plate from the ice discharge opening.
6. Support the bearing bracket to keep it from falling into the tank. Loosen and remove the four cap screws and lock washers from the ends of the bearing bracket support arms.
7. Lift the bracket and cutter disc from the tank. Check that the support arms are match marked for reassembly. If necessary, gently drive the support arms up or down to release them from the tank wall.
8. After removal, turn the bracket and disc assembly over, with the disc assembly facing up. Remove the cotter pin from the shaft.
9. Loosen and remove the slotted hex nut, spring washer, and spacer.
10. Remove the cutter disc from the keyed shaft, exercising caution not to lose the shaft key.

The cutter shaft and bearings are sealed in the bearing bracket assembly. The cavity between the bearings has been filled with a food-grade grease to prevent the presence of moisture and to prolong the life of the unit. If any vertical or side move exists in the shaft or if the bearings feel rough or tight when turning the shaft, the assembly should be dismantled and rebuilt. Refer to Figure 76 for parts location and identification.

Cutter Shaft and Bearing Removal

Follow the steps below. Refer to Figure 76. Use only a soft mallet for fitting all parts in place.

1. Turn off the power and lock out the disconnect.
2. Follow the instructions for removal of the water tank, above.
3. Follow the instructions for removal of the cutter assembly, above.
4. Follow the instructions for removal of the bearing bracket and cutter disc, above.
5. Press the shaft out of the housing from the bottom up.

Note: The two top bearings may come out with the shaft along with the upper seal and excluder.

6. Turn the bracket over and press the bottom bearing out of the bottom, along with the lower seal.
7. Remove the three spacers on the shaft as they are made accessible. Label them according to their location within the housing.
8. Clean and inspect all parts for wear or damage. Discard all parts showing any indication of damage.

Cutter Ring Gear Replacement

Follow the steps below. Refer to Figure 76.

1. Turn off the power and lock out the disconnect.
2. Follow the instructions for removal of the water tank, above.
3. Follow the instructions for removal of the cutter assembly, above.
4. Remove the ¼" drive pins holding the ring gear to the cutter assembly.
5. Progressively and uniformly remove press the ring gear from the cutter assembly, working around the circumference to avoid binding. The ring gear is a shrink fit onto the cutter assembly.
6. Inspect and clean the cutter ring gear seating surface, removing any burrs, scale or dirt.
7. Test fit the new ring gear onto the cutter assembly and check for fit. The ring gear may need to be heated to fit properly, allowing for a shrink fit after cooling.
8. To heat the ring gear for proper fit, first move it away from the cutter and heat the gear uniformly to 300° to 400°F (150°C to 205 °C). **DO NOT HEAT THE CUTTER.**
9. Align the valley of the ring gear teeth with the existing drive pin holes and carefully set the ring gear onto the cutter assembly. Check that it is fully seated on the machined shoulder of the cutter.
10. After the new ring gear has cooled, drill ¼" holes in the valley of the gear teeth using the existing holes in the cutter as a guide.
11. Install the drive pins checking that they do not protrude and interfere with the engagement of the drive gear.
12. Install the cutter assembly onto the shaft.
13. Check and adjust the cutter height and meshing of the gear teeth.

Cutter Blade Replacement

The cutter blades are designed to give many years of satisfactory service and rarely need to be adjusted. If they become damaged, they can be replaced following the steps below. Refer to Figure 75 and Figure 76.

1. Turn off the power and lock out the disconnect.
2. Follow the instructions for removal of the water tank, above.
3. Follow the instructions for removal of the cutter assembly, above.
4. Remove the 3/8" cap screws holding the blades to the cutter plate and remove the blades.
5. Set the new blades in place and install the cap screws and washers. Hand tighten.
6. Referring to Figure 75, adjust each blade to Dimension "A" and lock the blade in position by tightening the 3/8" cap screws. Use a square to obtain the proper blade clearance required for satisfactory ice discharge. Dimension "A" is critical and must be measured at both ends of the blade. Cap screws must be flush with the top of the cutter blade – use a fine grinder if necessary to trim any excess threads.
7. Check that all bolts and nuts are tightened securely.

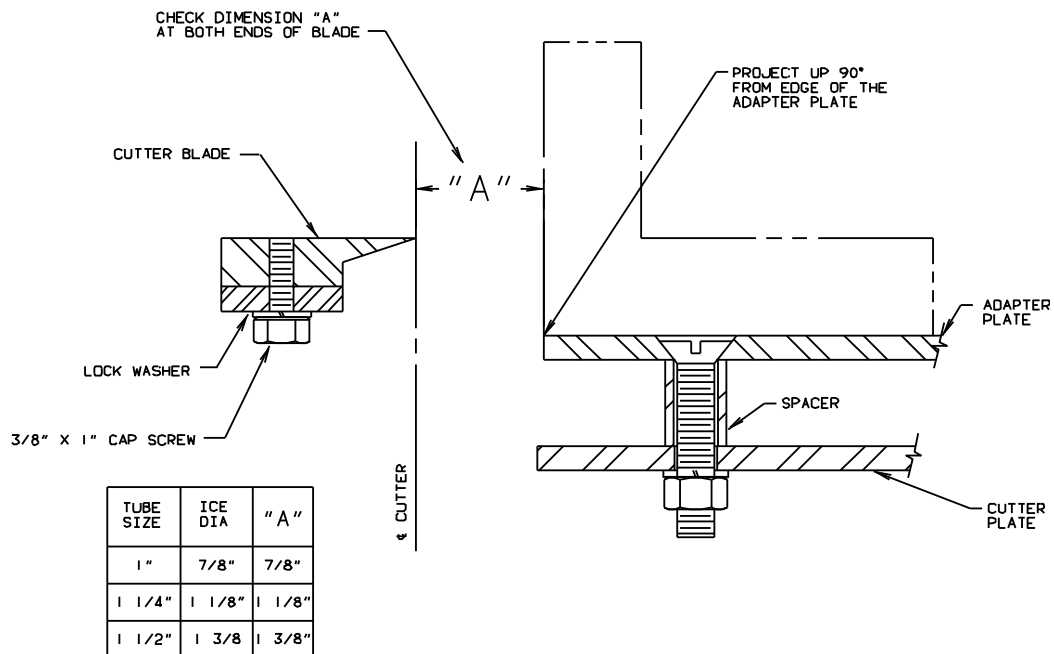

Figure 75: Cutter Blade and Adapter Plate Adjustment

Cutter Adapter Plate Installation

Follow the steps below. Refer to Figure 75 and Figure 76.

1. Turn off the power and lock out the disconnect.
2. Follow the instructions for removal of the water tank, above.
3. Follow the instructions for removal of the cutter assembly, above.
4. Locate the new adapter plate, holding the correct Dimension "A" from the edge of the plate to the edge of the blade. Refer to Figure 75.
5. Using two C-Clamps to hold the adapter plate securely, drill four 7/16" holes through the adapter plate and through the cutter plate at the same time to ensure that they adjoin properly.
6. Countersink the holes in the adapter plate to make the bolt heads flush with the top of the plate.
7. Install bolts and spacers as illustrated in Figure 75 and tighten securely. The length of the ice is determined by the spacer length.

Cutter Shaft and Bearing Installation

Follow the steps below to install the cutter shaft and bearing back into the housing after disassembly. Refer to Figure 76. Use only a soft mallet for fitting all parts in place.

1. Clean the inside of the bearing housing of all grease and foreign matter.
2. Clean the top bearing housing with pro-lock cleaner and primer, or equivalent, and remove the pipe plugs from the side of the housing.
3. Apply a thin coat of Loctite® RC/609 retainer, or equivalent, to the inner surface and bearing shoulder of the top of the bearing bracket.
4. Insert a bearing in the top housing and press it onto the shaft.
5. Slide the upper bearing spacer onto the shaft and begin pressing the shaft down through the middle bearing of the housing. Do not start the top shaft bearing in the housing.
6. Partially fill the housing with grease (MPG-2 or other USDA approved grease). Use enough to fill the area between the two upper bearings, forcing some out of the pipe plughole when the shaft and top bearing are seated.
7. Finish pressing the shaft and bearing into the housing until firmly seating.

8. Turn the bracket and shaft upside down and fill the housing around the shaft with gear (MPG-2 or other USDA approved grease).
9. Slide the lower bearing space over the shaft and into the housing.
10. With the top end of the shaft supported, install the lower bearing on the shaft, pressing in down into the housing firmly against the housing shoulder.
11. Slide the seal spacer (ridge end in, flat end out) and seal (open face out) onto the shaft together.
12. Uniformly tap the seal into the housing against its shoulder.

Note: The purpose of the seals and excluders are to prevent moisture from entering the housing area, not to hold the grease in.

13. Wipe off the excess grease and install the pipe plugs.
14. Install the largest excluder on the bracket as illustrated by the assembly drawing.
15. Install the tines disc, key, spacer, spring washer, slotted hex nut, and cotter pin.
16. Turn the assembly right side up and install in the water tank. Locate the support arms as they were match marked when removed.
17. Secure the support arms in place using the cap screws and lock washers. Tighten to 90 ft-lb (122 N-m).
18. Install the top water excluder.
19. Install the splash shield and ice deflect plate in the ice discharge opening.
20. Install the cutter assembly, using the key to align the key ways and lock the cutter and shaft together.
21. Install the gasket, retainer, and cap screw. Tighten to 15 ft-lb (20 N-m).
22. Check and adjust the cutter height according to the Cutter Height Adjustment instructions, below.

Cutter Height Adjustment

The height of the cutter can be adjusted by the four bolts holding the bearing bracket assembly in place. These bolts are threaded into holes in the end of each arm through holes in the water tank. The washers are welded in place after the cutter height is properly adjusted at the factory to ensure proper adjustment during servicing.

Using a straight edge at least 40" long to reach across the top flange of the water tank, check that the top of the cutter rim clears the straight edge by at least 1/16" (1.6 mm) and not more than 3/16" (4.8 mm).

Fix one end of the straight edge and swing the other end around the top flange of the water tank, checking the clearance at multiple points.

With the straight edge laying across the width of the top flange of the water tank, rotate the cutter by hand, checking clearances once more. If adjustment is necessary, loosen the four side bolts and raise or lower each arm as needed. After adjustment, tighten side bolts to 90 ft-lb (122 N-m).

Water Tank Installation

Follow the steps below.

1. Place the white gum rubber gasket on top of the tank flange. It can be held in place with narrow strips of tape through the bolt holes.
2. Roll the water tank under the machine and align the bolt holes in the top flange of the water tank with the matching holes in the bottom tubesheet of the freezer.
3. Tighten the nuts securely.
4. Reconnect the discharge chute or hopper to the ice discharge opening.
5. Moutng the water pump and attach the circulating water tubing and overflow tubing.
6. Reconnect all water piping to the tank. Close the water tank drain valve.
7. Turn on the water supply and check for leaks on pipes and fittings.
8. Fill the water tank with water and check for leaks on the tank.

When ready, connect power to the machine following proper lockout procedures. Do not operate the refrigeration system until the oil in the compressor crankcase is warm and contains no liquid refrigerant.

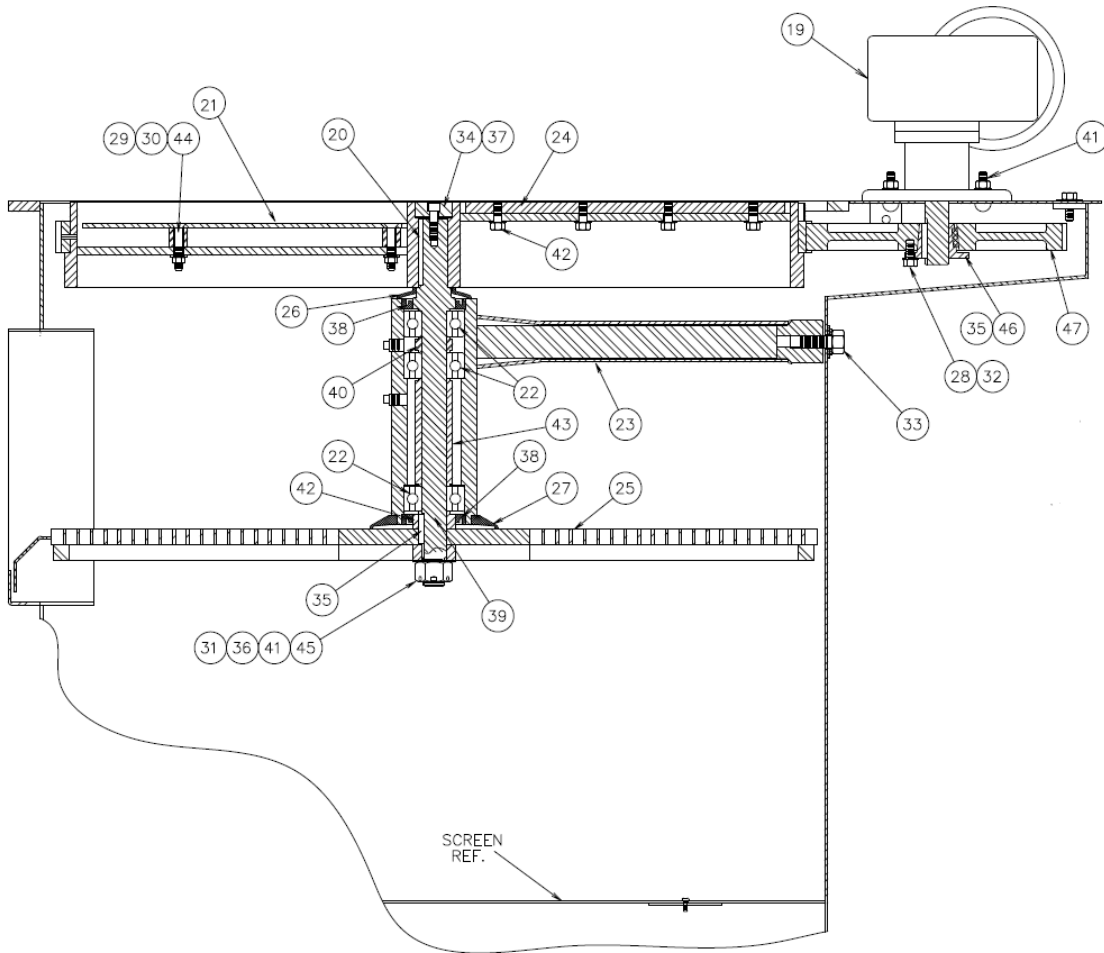

Figure 76: Cutter Assembly

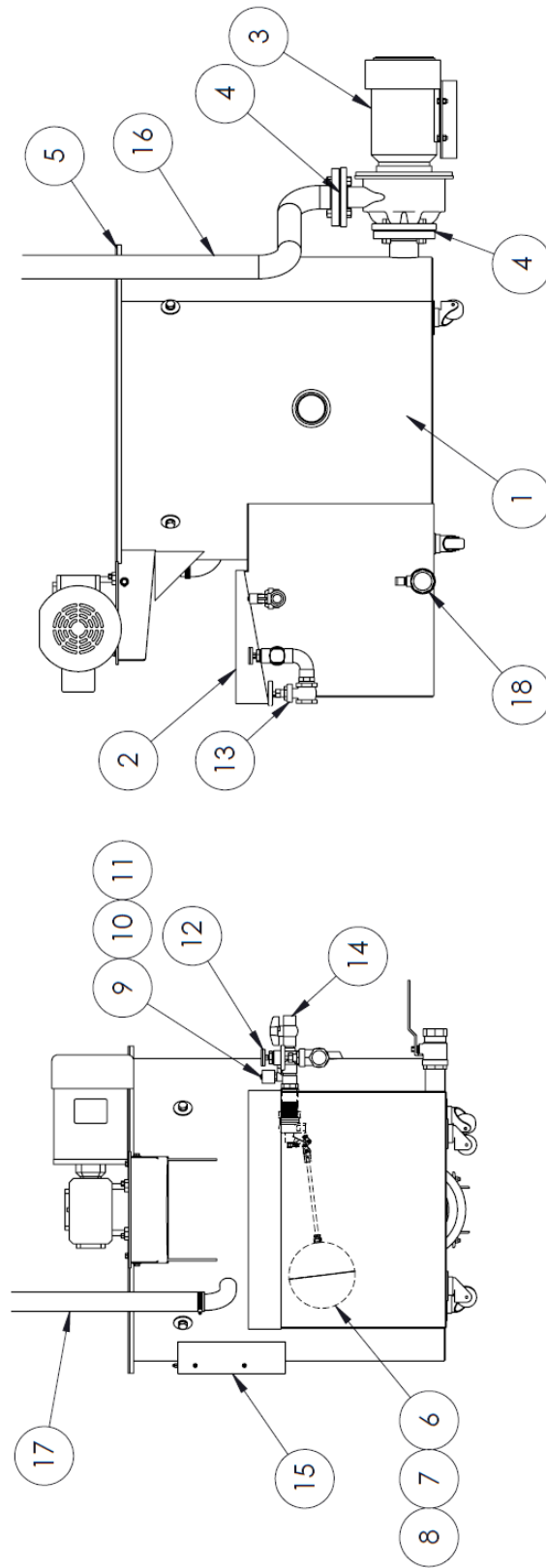

Figure 77: Water Tank Assembly

Table 11: Cutter and Water Tank Part Identification

Item	Part Description	Part Number
1	Water Tank Assembly	19T4500S34X
2	Water Tank Cover	19T2150C02X
3	Water Pump	12A4020G12
4	Water Pump Gasket (2)	12A2600R03
5	Water Tank Gasket	12A4200G11
6	Make-Up Water Float Valve (Valve Body)	12A4200H0603 or 12A4200H0603S
7	Make-Up Water Float Valve (Stem)	12A4200HP05 or 12A4200HP05S
8	Make-Up Water Float Valve (Float + Stem Adapter)	12A4200HP04, 12A4200HP05A or 12A4200HP05AS
9	3/4" Water Tank Flush Valve Solenoid	12A4200A0607LF
10	Water Tank Flush Valve Solenoid Coil (230V)	12A2105C42K
11	Water Tank Flush Valve Solenoid Coil (120V)	12A2105C41K
12	Make-Up Water Thermometer	12A4170T01
13	1-1/2" Make-Up Water Shut Off Valve	12A4205G0603LF
14	3/4" Flush Water Shut Off Valve	12A2450V04
15	Ice Discharge Curtain	12A4078C02
16	Circulating Water Tubing (Clear)	12A4181T15
17	Overflow Water Tubing (Clear)	12A4181T09
18	2" Water Tank Drain Valve	12A4200G1401LF
19	Gear Motor & Reducer	12A2900M0806A
20	Upper Cutter Shaft Keyway	19T2785S0200
21	Cutter Adapter Plate (2)	19T2010A13
22	Cutter Shaft Bearing (3)	12A2020M02
23	Cutter Bearing Bracket Assembly	19T2025B0162
24	Cutter Blade (2)	19T2035B02
25	Tines Disc Assembly	19T2163D0403
26	Upper Excluder Seal	12A2210E01
27	Lower Excluder Seal	12A2210E04
28	5/16" Cap Screw for Drive Gear (3)	12A2215G111
29	3/8" Machine Screw for Adapter Plate (8)	12A2226H1117
30	3/8" Hex Nut (8)	12A2240A1309
31	Tines Disc Slotted Nut	12A2240E1216
32	5/16" Lock Washer (3)	12A2250B108
33	5/8" Lock Washer (4)	12A2250B113
34	Retaining Gasket	12A2600R02
35	Lower Cutter Shaft Key	19T2785S0100

Item	Part Description	Part Number
36	Cotter Pin	12A3040S06
37	Cutter Retaining Spacer	19T4065R01
38	Cutter Shaft Seal (2)	19T4080S02
39	Cutter Shaft	19T4090S03
40	Upper Bearing Spacer	19T4130C01
41	Tines Disc Hub Spacer	19T4130C02
42	Seal Spacer	19T4130C03
43	Lower Bearing Spacer	19T4130C04
44	Cutter Adapter Plate Spacers (8)	19T4130T09
45	Disc Spring	12A4138S01
46	Drive Motor Split Taper Bushing	12B2060B02
47	Cutter Drive Gear	12B2615D05

Circulating Water Pump Motor

The motor bearings are pre-lubricated and sealed. They require no further lubrication. The pump should operate the water level above the impeller housing to prevent burnout.

The pump is equipped with a mechanical seal that is self-adjusting and requires no lubrication. However, the pump should not be operated unless circulating water. The pump manufacturer recommends that a mechanical seal be kept as a spare. When ordering a seal, specify pump size, type, serial number, and manufacturer's name as indicated on the nameplate.

Crushed Ice Production

Crushed ice conversion is not possible on this machine.

Appendix A Optional Accessories

The following sections describe the optional accessories available.

Power Monitor, Wagner Model DTP-3

All Vogt Tube-Ice® machine models are available from the factory with a three-phase line voltage power monitor, incorporating an LCD display, called the DTP-3, as shown in Figure 78. The units are also available for aftermarket or retrofit installation. These units monitor line voltage inputs from 190 to 610 volts and provide protection against line voltage variances, which can damage or destroy the compressor motor.

Features include:

- Non-volatile system memory to retain settings when power is lost.

If the machine is ordered with this option, the power monitor can be factory set to customer specifications. The Vogt part number for a power monitor retrofit kit is [12A7700K01](#).

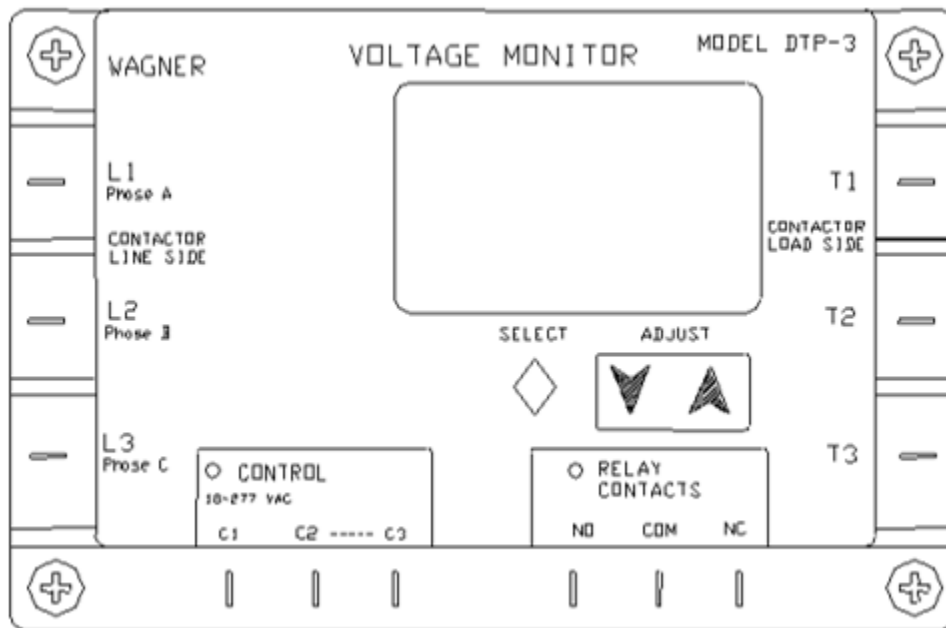

Figure 78: Power Monitor (Voltage Monitor)

The Display

The display normally shows phase A to B, phase B to C, and C to A line voltages. If the unit is on a timer, that timer will be displayed. The timer display may be switched off by pressing **SELECT**. The LCD will then display the normal A-B, B-C, C-A line voltage pairs.

Pressing **SELECT** once shows the contactor load side voltages (if the load side option is connected). The display automatically returns to the display of line side voltage after a few seconds.

Press **SELECT** to step through the parameters, as shown in Table 12. The selected parameter will flash. Use the up and down arrow keys to select the desired operating value.

Table 12: Power Monitor Parameters

Parameter (Description, units)	Min.	Max.	Default	Recommended Settings
Line Side Voltage (Nominal Voltage, volts)	90	650	208	Supply voltage
Over Voltage (tolerance, %)	6	18	12	10
Under Voltage (tolerance, %)	6	18	12	10
Phase Unbalance (%)	2	25	6	5
Lockout Time (Delay on Break, seconds)	0.1	25	0.5	120
Delay Time (Delay on Make, seconds)	0	30	0	0
Response Time (Delay on Fault, seconds)	0.1	20	2	2
Control Mode (none)	Off / Auto / On		Auto	On
Contactorm Test (Volt Diff)	OFF	5	OFF	OFF

Adjustment of Parameters in Order of Display

The following describes how to adjust the power monitor parameters in order of display if adjustment is needed.

- **Line Voltage**—This gives an active display of the line voltage to the machine. By default, this is the normal display.
- **Load Side Voltage**—If connected, this provides an active display of the load side voltage in the machine.
- **Voltage Setpoint** (VAC Flashes)—Press the UP and DOWN arrows. This may be set to the normal operating voltage of the device being protected. Adjustment increments are 1 volt.
- **Under/Over Voltage Tolerance** (UNDERVOLTAGE/OVERVOLTAGE Flashes)—Press the UP and DOWN arrows. The tolerance is displayed in percentages.
- **Imbalance Voltage Tolerance** (% IMBALANCE Flashes)—This value may be adjusted by pressing the UP and DOWN arrows.
- **Lockout Time** (SECONDS Flashes)—This value may be adjusted by pressing the UP and DOWN arrows. This is the delay-on-break timer value.
- **Delay Time** (RESP. SECONDS Flashes)—This display shows time in seconds and tenths of seconds. This value may be adjusted by pressing the UP and DOWN arrows. This is the time that a fault is allowed before shutdown occurs.
- **Control Mode** (ON OFF AUTO Flashes)—This value may be adjusted to OFF (load will not turn on), ON (load will turn on whenever no faults exist and timers are finished), and AUTO (load will turn on when a control input is active).
- **Contactorm Fault Monitor Mode** (CONTACTOR FAULT Flashes)—This option allows for monitoring of the contactor and provides lock-out if the line voltage and load side voltage vary by more than five (5) volts. Pressing the UP or DOWN arrow will toggle between OFF (default) and ON. The load side of the contactor must be connected to the load terminals of the power monitor to use this option.
- **Display of Fault Memories** (MEM Flashes)—Pressing UP or DOWN arrow displays the last fault conditions that shut down the machine. The first 25 faults are recorded. The top number displayed represents the fault memory. The middle number represents the total number of faults that have occurred since the fault memory was cleared. To clear the memory, press and hold both the UP and DOWN arrows until the display is cleared.

Notes

- If the SELECT button is pressed and no parameters are changed by pressing the UP or DOWN arrow keys, the DTP-3 will automatically return to a display showing the line voltage.
- New settings are saved in permanent memory when the display returns to showing the line voltage. New settings may be verified by pressing the SELECT button to scroll through the parameters.
- To prevent tripping on a one (1) volt change, the DTP-3 automatically calculates cut-in voltages for the return from undervoltage conditions. The cut-out out voltage is always based on user voltage and tolerance settings, while the cut-in voltage is 3% closer to the nominal voltage setting. This quality is referred to as hysteresis. This is to help reduce oscillation that may occur on a weak power distribution system. When the load is switched off due to undervoltage, the line voltage will increase. Without hysteresis, the monitor would switch the load back on, the line voltage would again drop, and cause continuous on-off-on cycling.

Appendix B Tables

Table 13: P34HL Specifications (460, 3-phase, 60 Hz)

Tube Size	in. (mm)	1 (25)	1-1/4 (32)	1-1/2 (38)
Nominal Capacity ⁽¹⁾	lb/day (kg/day)	93,200 (42,200)	88,600 (40,100)	77,000 (34,900)
Overall Dimensions (L x W x H)	in. (cm)	78 x 80 x 205 (198 x 203 x 521)		
Shipping Weight	lb (kg)	11,350 (5,150)	10,800 (4,900)	10,600 (4,810)
Operating Weight	lb (kg)	13,020 (5,910)	12,470 (5,660)	12,270 (5,570)
Refrigerant Charge (R-513A)	lb (kg)	2,400 (1,090)	1,900 (860)	1,800 (820)
Total FLA, 60 Hz	Amps	13.3		
Maximum Fuse, 60 Hz	Amps	30		
Minimum Ampacity, 60 Hz	Amps	16		
Water Requirements				
-makeup ⁽²⁾	gpm (m ³ /hr)	11.2 (2.4)		
-condenser	gpm (m ³ /hr)	300 (68.5)		
Connection Sizes				
-makeup water	MPT in. (DN mm)	1-1/4		
-tank drain	FPT in. (DN mm)	2		
-tank overflow	FPT in. (DN mm)	3		
-flush water	FPT in. (DN mm)	3/4		
Compressor, 60 Hz, pulldown ⁽³⁾	HP/KW/RLA	175 / 131 / 187		
Water Pump, 60 Hz	HP/KW/FLA	7.5 / 5.6 / 10.8		
Cutter Motor, 60 Hz	HP/KW/FLA	2 / 1.5 / 2.8		
THR, pulldown	kBTU/hr (kW)	2,482 (727)		

(1) Nominal capacity is based on 70°F (21°C) makeup water, 100°F (38°C) condensing temperature, 70°F (21°C) amb, and 25% blowdown.

(2) Makeup water is maximum value and includes 25% blowdown.

(3) RLA=MCC/1.56

Vogt reserves the right to change designs and specifications without notice.

Table 14: Condenser Water Usage

Condensing Temp. °F (°C)	Entering Water Temp. °F (°C)	Leaving Water Temp. °F (°C)	Water Flow gpm (m³/hr)	Pressure Drop psig (bar)	Average Total Heat of Rejection kBTU/hr (kW)
100 (38)	50 (10)	95 (35)	85 (19)	1 (0.069)	1,853 (543)
100 (38)	55 (13)	95 (35)	95 (22)	1 (0.069)	1,853 (543)
100 (38)	60 (16)	95 (35)	110 (25)	1 (0.069)	1,853 (543)
100 (38)	65 (18)	95 (35)	125 (28.5)	1 (0.069)	1,853 (543)
100 (38)	70 (21)	95 (35)	150 (34)	2 (0.14)	1,853 (543)
100 (38)	75 (24)	95 (35)	185 (42)	3 (0.21)	1,853 (543)
100 (38)	80 (27)	95 (35)	245 (55.7)	5 (0.34)	1,853 (543)
100 (38)	85 (29)	95 (35)	375 (85.2)	12 (0.83)	1,853 (543)

Table 15: Makeup Water Usage, gpm (m³/hr)

Makeup Water (with 25% blowdown)	Cylinder Ice		
	Tube Size in. (mm)		
Temp. °F (°C)	1 (25)	1-1/4 (32)	1-1/2 (38)
40 (4)	9.5 (2.2)	10.6 (2.4)	9.6 (2.2)
50 (10)	9.0 (2.0)	10.0 (2.3)	9.0 (2.0)
60 (16)	8.5 (1.9)	9.4 (2.1)	8.6 (1.9)
70 (21)	8.0 (1.8)	8.9 (2.0)	8.1 (1.8)
80 (27)	7.7 (1.7)	8.5 (1.9)	7.7 (1.7)
90 (32)	7.3 (1.6)	8.0 (1.8)	7.3 (1.6)

Table 16: Temperature – Pressure Chart for R-513A

Deg (°F)	Sat Liq P (psig)	Sat Vap P (psig)	Deg (°F)	Sat Liq P (psig)	Sat Vap P (psig)	Deg (°F)	Sat Liq P	Sat Vap P	Deg (°F)	Sat Liq P	Sat Vap P
-40	-5.9	-6	25	26	26	66	71.3	71.3	107	147.1	147.1
-35	-4.6	-4.7	26	26.8	26.8	67	72.7	72.7	108	149.4	149.4
-30	-3.1	-3.2	27	27.6	27.6	68	74.2	74.2	109	151.8	151.8
-25	-1.5	-1.6	28	28.5	28.4	69	75.7	75.7	110	154.1	154.1
-20	0.2	0.1	29	29.3	29.3	70	77.2	77.2	111	156.5	156.5
-15	2.2	2.1	30	30.2	30.2	71	78.7	78.7	112	159	158.9
-10	4.3	4.3	31	31.1	31.1	72	80.2	80.2	113	161.4	161.4
-9	4.8	4.7	32	32	32	73	81.8	81.8	114	163.9	163.8
-8	5.2	5.2	33	32.9	32.9	74	83.4	83.4	115	166.4	166.3
-7	5.7	5.6	34	33.8	33.8	75	85	85	116	168.9	168.9
-6	6.2	6.1	35	34.8	34.7	76	86.6	86.6	117	171.4	171.4
-5	6.7	6.6	36	35.7	35.7	77	88.2	88.2	118	174	174
-4	7.2	7.1	37	36.7	36.6	78	89.9	89.9	119	176.6	176.6
-3	7.7	7.6	38	37.7	37.6	79	91.5	91.5	120	179.3	179.2
-2	8.2	8.1	39	38.6	38.6	80	93.2	93.2	121	181.9	181.9
-1	8.7	8.7	40	39.7	39.6	81	94.9	94.9	122	184.6	184.6
0	9.3	9.2	41	40.7	40.7	82	96.7	96.7	123	187.3	187.3
1	9.8	9.7	42	41.7	41.7	83	98.4	98.4	124	190	190
2	10.4	10.3	43	42.8	42.7	84	100.2	100.2	125	192.8	192.8
3	10.9	10.9	44	43.8	43.8	85	102	102	126	195.6	195.6
4	11.5	11.4	45	44.9	44.9	86	103.8	103.8	127	198.4	198.4
5	12.1	12	46	46	46	87	105.7	105.7	128	201.3	201.2
6	12.7	12.6	47	47.1	47.1	88	107.5	107.5	129	204.2	204.1
7	13.3	13.2	48	48.2	48.2	89	109.4	109.4	130	207.1	207
8	13.9	13.8	49	49.4	49.4	90	111.3	111.3	131	210	209.9
9	14.5	14.4	50	50.5	50.5	91	113.2	113.2	132	213	212.9
10	15.1	15.1	51	51.7	51.7	92	115.2	115.2	133	216	215.9
11	15.8	15.7	52	52.9	52.9	93	117.1	117.1	134	219	218.9
12	16.4	16.4	53	54.1	54.1	94	119.1	119.1	135	222.1	222
13	17.1	17.1	54	55.3	55.3	95	121.1	121.1	140	237.8	237.7
14	17.8	17.7	55	56.6	56.5	96	123.2	123.2	145	254.3	254.2
15	18.5	18.4	56	57.8	57.8	97	125.2	125.2	150	271.6	271.5
16	19.2	19.1	57	59.1	59.1	98	127.3	127.3			
17	19.9	19.8	58	60.4	60.4	99	129.4	129.4			
18	20.6	20.6	59	61.7	61.7	100	131.5	131.5			
19	21.3	21.3	60	63	63	101	133.7	133.7			
20	22.1	22	61	64.3	64.3	102	135.9	135.9			
21	22.8	22.8	62	65.7	65.7	103	138.1	138.1			
22	23.6	23.6	63	67.1	67.1	104	140.3	140.3			
23	24.4	24.4	64	68.5	68.5	105	142.5	142.5			
24	25.2	25.1	65	69.9	69.9	106	144.8	144.8			

Table 17: Constants

Specific Heat of Water	1 BTU/(lbm °F) 1 calorie/gram °C
Specific Heat of Air	4.19 Kj/(kg °C) 0.24 BTU/(lbm °F)
Tube-Ice Density	32-35 lb/ft ³ 0.51-0.56 gm/cm ³
Ice Latent Heat	144 BTU/hr (42 watts/hr)
Water Sensible Heat	1 BTU/(lb °F) (4,182 Joules/kg °C)
Ice Melting Effect 1 Ton Refrigeration	12,000 BTU/hr (3.5 kw/hr)
Atmospheric Pressure	14.7 psia (760 mmHg)
Weight of Water	62.4 lb/ft ³ 1,000 kg/m ³ 8.33 lb/gal
1 gpm Water 3.79 L/min	12,013 lb/day 5,449 kg/day
Weight of Air	0.0749 lb/ft ³ (0.0100 lb/gal)
1 Horsepower	2,545.6 BTU/hr (46 watts)
1 Kilowatt	1.34 horsepower 3,411 BTU/hr
Gravitational Acceleration	9.81 m/sec ²

Appendix C Additional Documentation

The following lists other documents for your reference.

- OSHA Standard: The Control of Hazardous Energy (Lockout/Tagout) (29 CFR 1910.147)
- R-513A Safety Data Sheet
- Bitzer Semi-Hermetic Compact Screw – CS Compressor Manual
- Water Conditioning Technical Service Bulletin 88-5
- Compressor Oil BSE-32 Safety Data Sheet
- Gear Reducer Oil Safety Data Sheet

Notes

Notes



Vogt Ice®, LLC
1000 W. Ormsby Ave.
Suite 19
Louisville, KY 40210 USA
Since 1880