

CONDENSING GAS BOILER Models 075 & 100

WALL MOUNTED
GAS BOILER

**INSTALLATION, OPERATION &
MAINTENANCE MANUAL**



ECR international
EST. 1998
A Family of Heating & Cooling Brands.

Manufactured by:
ECR International, Inc.
2201 Dwyer Avenue, Utica NY 13501
web site: www.ecrinternational.com

VERIFY CONTENTS RECEIVED

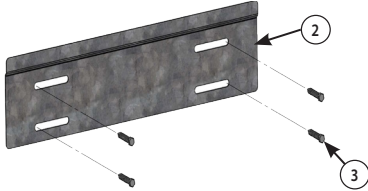
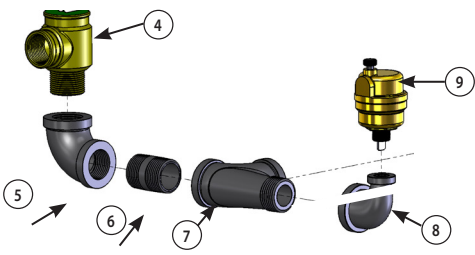
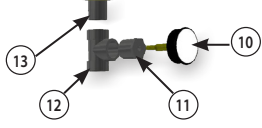
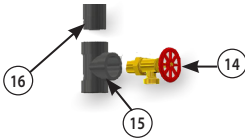
Description Item	No.	Illustration
Fully Assembled Boiler	1	
Metal Wall Bracket	2	
Lag Bolt, 3/8" x 3" Hex (4 ea)	3	
*Safety Relief Valve	4	
3/4" Elbow 90°	5	
3/4" Close Nipple	6	
3/4" F x 3/4" M NPT Tee	7	
3/4" x 1/4" NPT 90° Elbow	8	
Air Vent	9	
**Temperature Pressure Gauge	10	
Bushing 3/4" x 1/4"	11	
3/4" Tee (Same as No. 11)	12	
Nipple 1 1/4 x 5/2	13	
Drain Valve, 3/4"	14	
3/4" Tee	15	
Nipple 1 1/4 x 5/2	16	
Bushing 7/8" OD, Heyco (2 ea)	17	Used for electrical wire knockouts.
Outdoor Sensor	18	Used for measuring outside temperature.
Stopper, Rubber 5/16" (2 ea)	17	Used for packaging holes on back of boiler.
Plastic Plug (2 ea)	18	Used for packaging holes on back of boiler.
Outdoor Sensor	19	Used for measuring outside temperature.
Document Package	20	Includes essential documents.

* Boiler provided with 30 psig (206 kpa) safety relief valve. Field source safety relief valve if system pressure greater than 25 psig.

** Boiler provided with 75 psig temperature pressure gauge. Field source temperature pressure gauge if system pressure greater than 60 psig.

DIMENSIONS

FIGURE 1-1 Dimensions

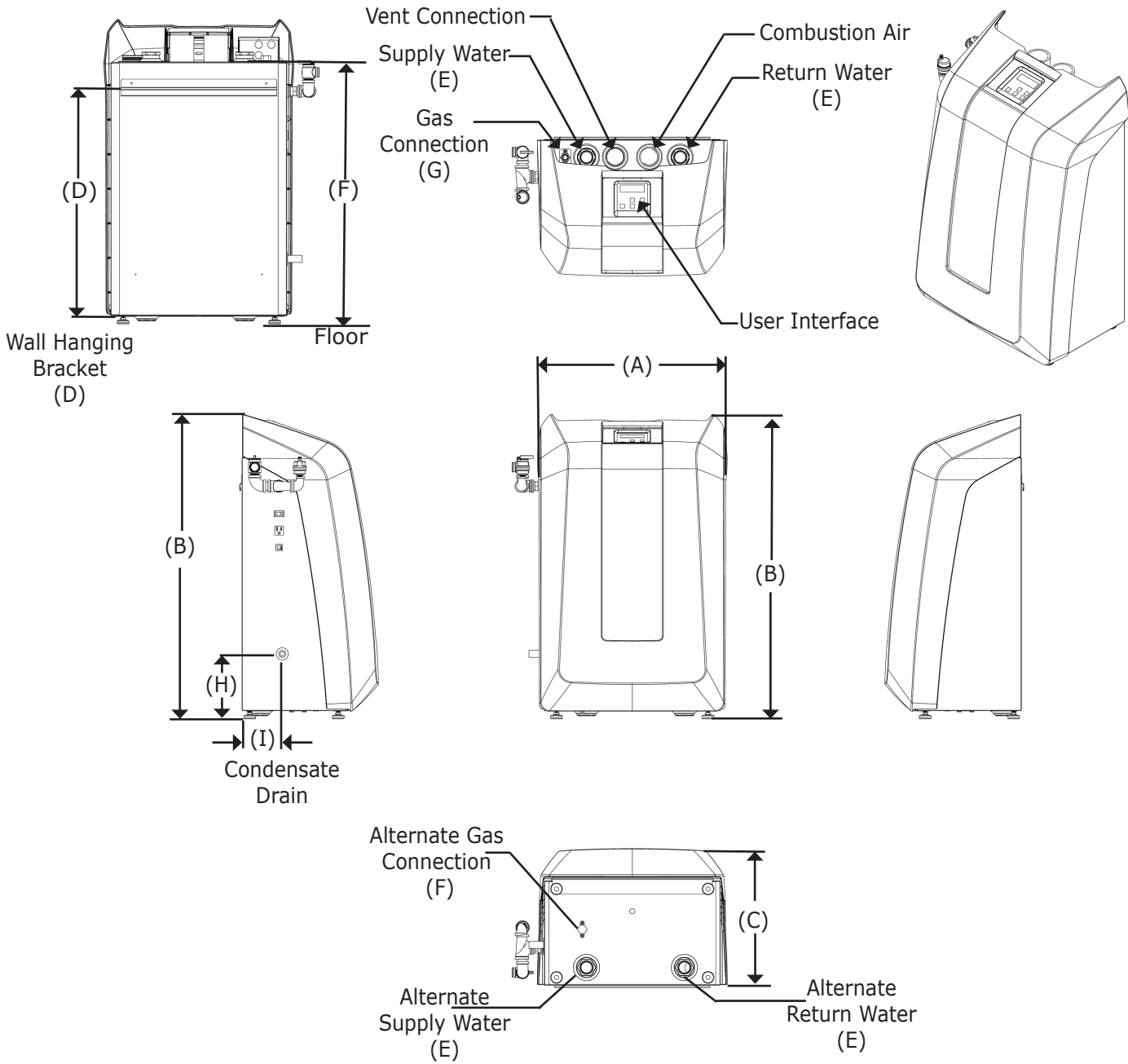

Table 1 : Physical Data

Size	Width (A)	Height (B)	Depth (C)	Bracket (D)	Water Connections		Gas Connection (G)	Condensate Drain		Weight	
					Size (E)	Height (F)		(H)	(I)	Shipping	Unit
075 /100	22-1/16" (560mm)	35-5/8" (905mm)	16-3/16" (411mm)	27-1/2" (969mm)	1-1/4" NPT	31-1/16" (789mm)	1/2" NPT	7-1/2"	5"	140 lb (63.5 kg)	115 lb (51.2 kg)

TABLE OF CONTENTS

1 - Introduction	5
2 - Important Safety Information	6
3 - Component Listing	7
4 - Locating Boiler	11
5 - Hydronic Piping	13
5.2 Special Conditions	13
5.3 Safety Relief Valve And Air Vent.....	13
5.4 Trim Piping	14
5.5 System Piping.....	14
6 - Combustion Air And Vent Piping	19
6.2 Removal Of Existing Boiler From Common Vent System.....	19
6.3 Venting Materials	19
6.4 Pipe Installation	20
6.5 Termination.....	20
6.7 Venting Configurations	21
6.8 SideVentingTerminalRequirements.....	26
6.9 Condensate Piping	28
7 - Gas Supply Piping	29
8 - Electrical Connections	31
8.2 Line Voltage Connections.....	31
8.3 External Connections	31
9 - Start Up Procedure	33
9.6 Perform Csd-1 Compliance Test.....	37
9.7 Complete Start Up Procedure.....	38
10 - Operating Instructions	39
11 - General Maintenance And Cleaning	40
12 - Ratings And Capacities	43
13 - Trouble Shooting	44
14 - Wiring Diagram	61
15 - Glossary	63
Appendix A - Control Module	65
1.1 Introduction	65
1.2 Operation.....	65
1.3 Status Indication	65
1.4 Sequence Of Operation	66
1.5 User Menu.....	68

1 - INTRODUCTION

1.1 Designated Use

- Hot water heating boiler.
- Indoor installation.
- Closet or alcove installation.
- Direct vent boiler.
- For use with natural gas or liquefied petroleum gases (LP/propane).

1.2 The unit *MUST NOT*:

- Directly heat potable water. Indirect heating is acceptable.
- Heat water with non-hydronic heating system chemicals present (example, swimming pool water).
- Exceed 150 psig (1.03 MPa) system pressure.
- Exceed 195°F (90.5°C) system design temperature.

1.3 Operational Features

- Modulating: 20-100%.
- Integral Dual Limit.
- Integral Low Water Cutoff (with test button).
- Outdoor Temperature Reset.
- Integral Multiple Boiler Control.
- Heat exchanger over heat protection.

Information and specifications outlined in this manual in effect at the time of printing of this manual. ECR International reserves the right to discontinue, change specifications or system design at any time without notice and without incurring any obligation, whatsoever.

Check our website frequently for updates: www.ecrinternational.com

2 - IMPORTANT SAFETY INFORMATION

2.1 General

Boiler installation shall be completed by qualified agency. See glossary for additional information.

WARNING

Fire, explosion, asphyxiation and electrical shock hazard. Improper installation could result in death or serious injury. Read this manual and understand all requirements before beginning installation.

2.2 Become familiar with symbols identifying potential hazards.



This is the safety alert symbol. Symbol alerts you to potential personal injury hazards. Obey all safety messages following this symbol to avoid possible injury or death.

DANGER

Indicates a hazardous situation which, if not avoided, WILL result in death or serious injury

WARNING

Indicates a hazardous situation which, if not avoided, could result in death or serious injury.

CAUTION

Indicates a hazardous situation which, if not avoided, could result in minor or moderate injury.

NOTICE

Used to address practices not related to personal injury.

2.3 Installation shall conform to requirements of authority having jurisdiction or in absence of such requirements:

- United States
 - National Fuel Gas Code, ANSI Z223.1/NFPA 54.
 - National Electrical Code, NFPA 70.
- Canada
 - Natural Gas and Propane Installation Code, CAN/CSA B149.1.
 - Canadian Electrical Code, Part I, Safety Standard for Electrical Installations, CSA C22.1

2.4 Where required by authority having jurisdiction, installation shall conform to Standard for Controls and Safety Devices for Automatically Fired Boilers, ANSI/ASME CSD-1.

Additional manual reset low water cutoff may be required.

2.5 Requirements for Commonwealth of Massachusetts:

Boiler installation must conform to Commonwealth of Massachusetts code 248 CMR which includes but is not limited to:

- Installation by licensed plumber or gas fitter.

3 - COMPONENT LISTING

3.1 Component Listing

1. **User Interface** - Displays information regarding boiler condition. Allows adjustment of boiler operating parameters. NOTE: Does not replace thermostat used to control central heating space.
2. **Combustion Air Inlet (2" PVC)** (see Section 6)
3. **Return Water From Heating System (In) 1-1/4" NPT** - Connections supplied to connection top and/or bottom of boiler. See Section 5.
4. **Low Voltage Terminal Strip** Connection of all low voltage wiring, including thermostat. See section 8.
5. **Igniter**
6. **Flame Sensor**
7. **Sight Glass** Permits observation of burner flame.
8. **Burner**
9. **Heat Exchanger**
10. **Condensate Collector**
11. **Return Water Temperature Sensor**
12. **Drain Valve**
13. **Heat Exchanger Ball Valve**
14. **Supply Water Outlet to Heating System (Out) 1-1/4"NPT** Connections supplied for connecting from either top or bottom of boiler. See section 5.
15. **Vent Temperature Sensor**
16. **Condensate Drain**) Boiler produces a liquid (condensate) as a by-product of combustion. Condensate must be piped to appropriate drain. See section 6.
17. **Heat Exchanger Pump**
18. **Gas Shutoff Valve** - Fuel supply isolation during servicing. See section 7
19. **Combustion Air Blower** Delivers proper quantity of combustion air, receives fuel from gas valve, mixes air and fuel sending mixture to burner for combustion.
20. **Gas (Control) Valve** Delivers proper quantity of fuel to Combustion Air Blower. See section 7.
21. **Supply Water Temperature Sensor and High Limit Switch**
22. **Low Water Cutoff** Senses inadequate quantity of water. Turns off boiler before damage can occur.
23. **Safety Relief Valve** Factory supplied, Field installed. See section 5.
24. **High Voltage Junction Box** For connection of 120V components. See section 8.
25. **Vent Connector** See section 6.
26. **Gas Connection** (See section 7.)
27. **Wall Hanging Support Bracket** (see page 7) - Integral to boiler. Allows optional wall mounting when used with supplied wall mounting bracket. See section 4.
28. **Auxiliary Power Outlet** Convenience outlet for condensate pump or service. Controlled by Service Switch (29)
29. **Service Switch**
30. **Air Vent**
31. **Central Heating Pump Circuit Breaker** 5 amp circuit breaker protects control module.
32. **Boiler Control Module**
33. **Internal Access Panel** (see page 9) - Gently pull upward then forward to access control module. Removable for access to internal components of boiler.
34. **Central Heating Pump Relay** (see page 9)
35. **Transformer** Supplies 24V power to low water cutoff.
36. **Air Pressure Switch** (not shown)
37. **Test Port** - (see page 8)
38. **Combustion Analysis Test Port** - (see page 8)

3 - COMPONENT LISTING

FIGURE 3-1 Boiler Components

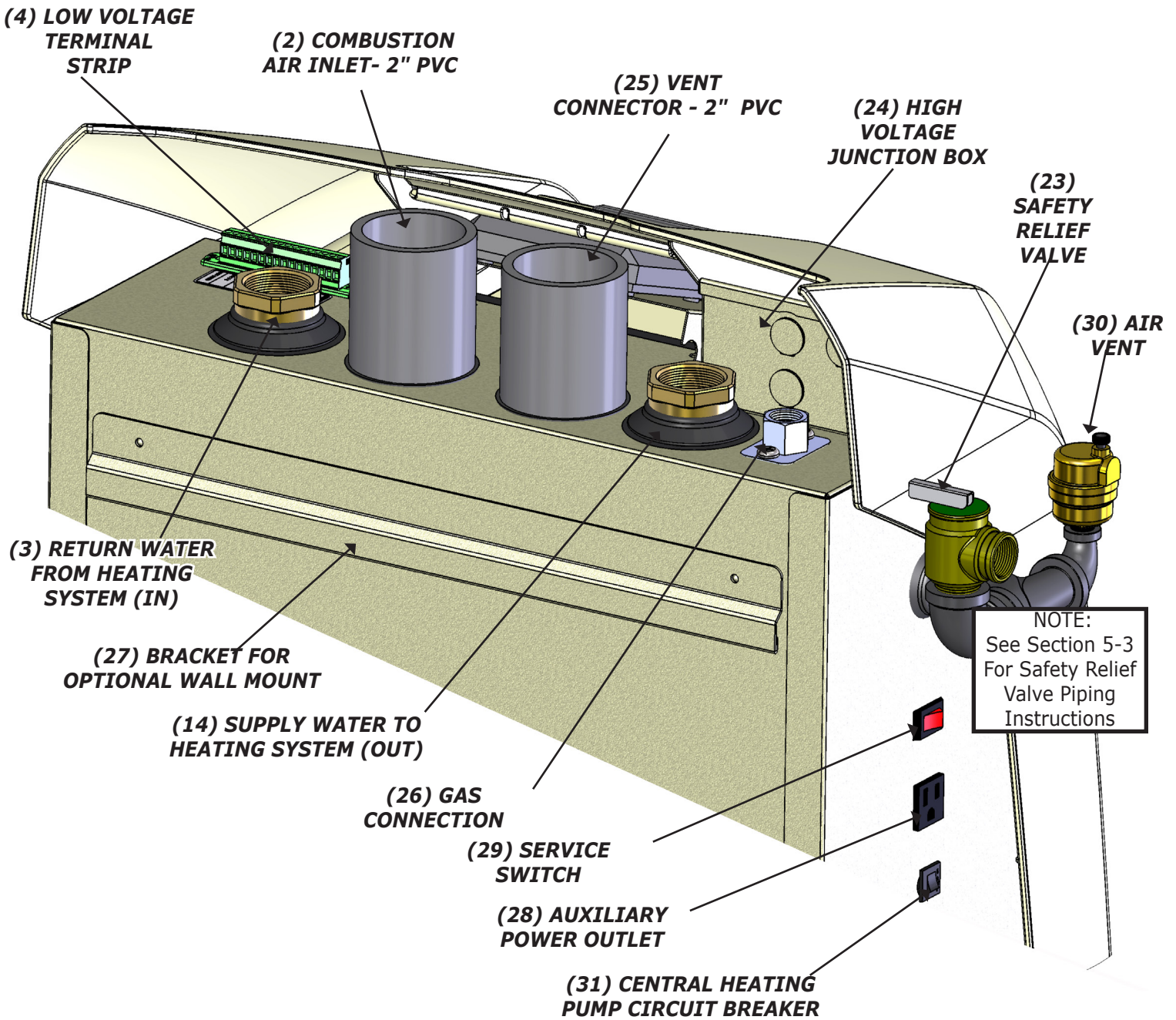

3 - COMPONENT LISTING

FIGURE 3-2 Boiler Components

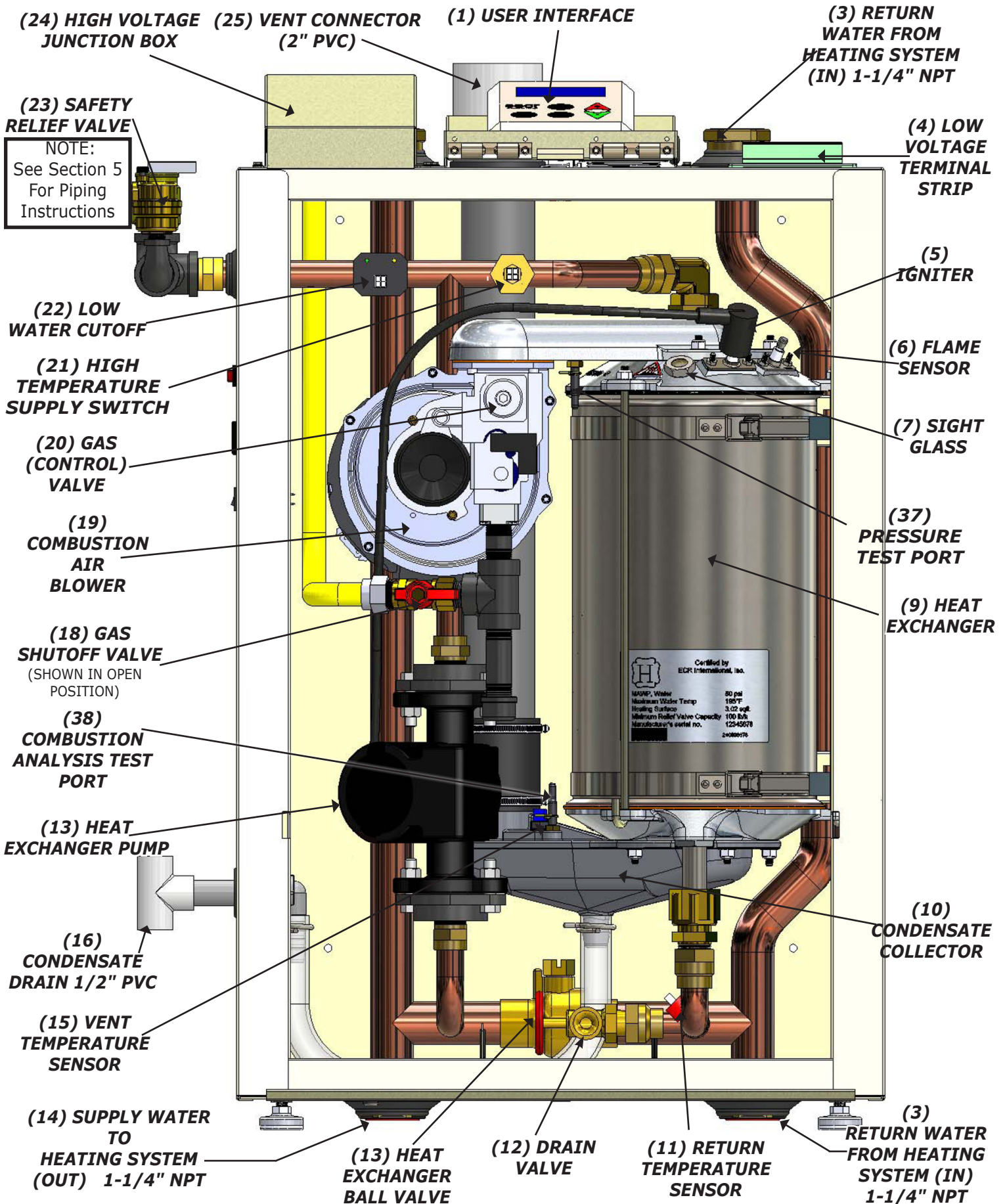

3 - COMPONENT LISTING

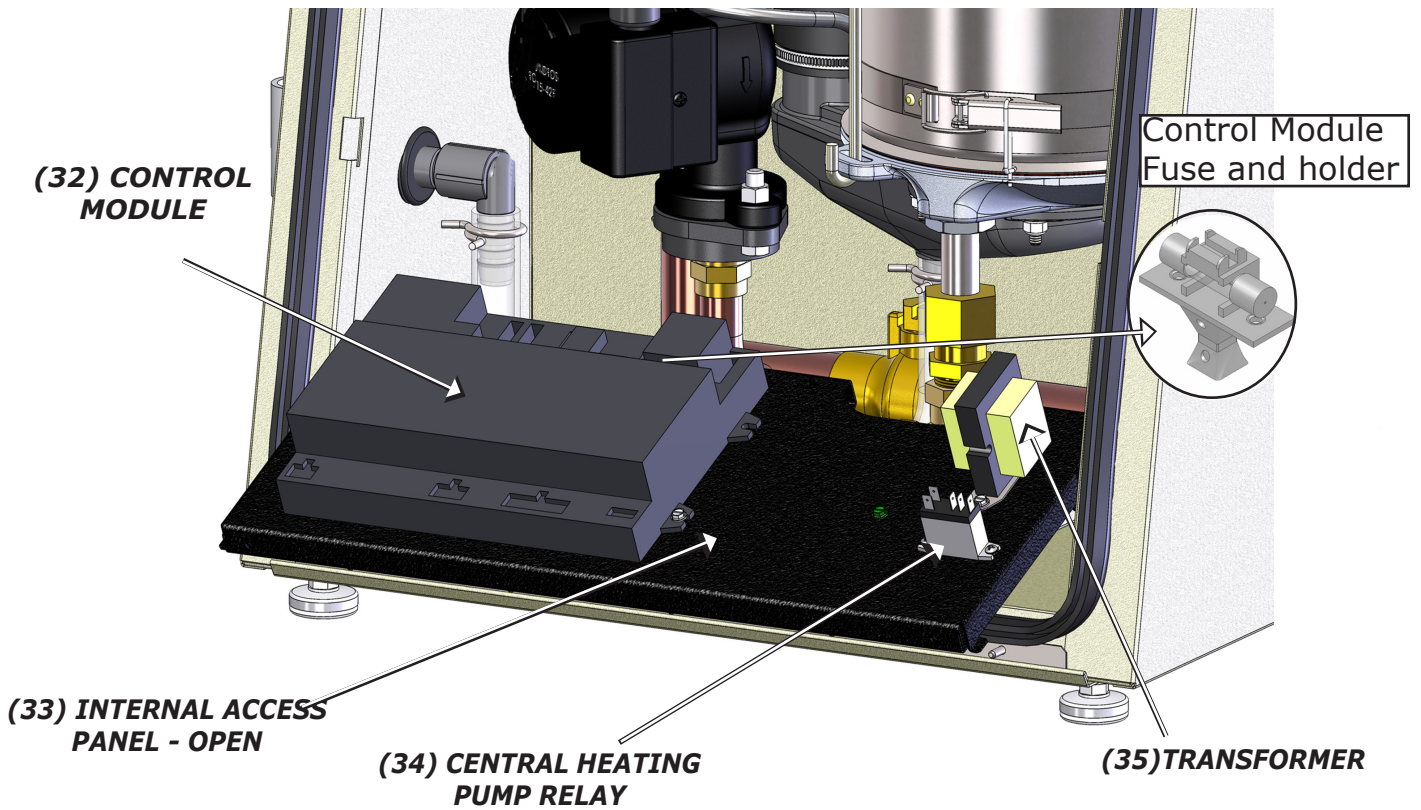
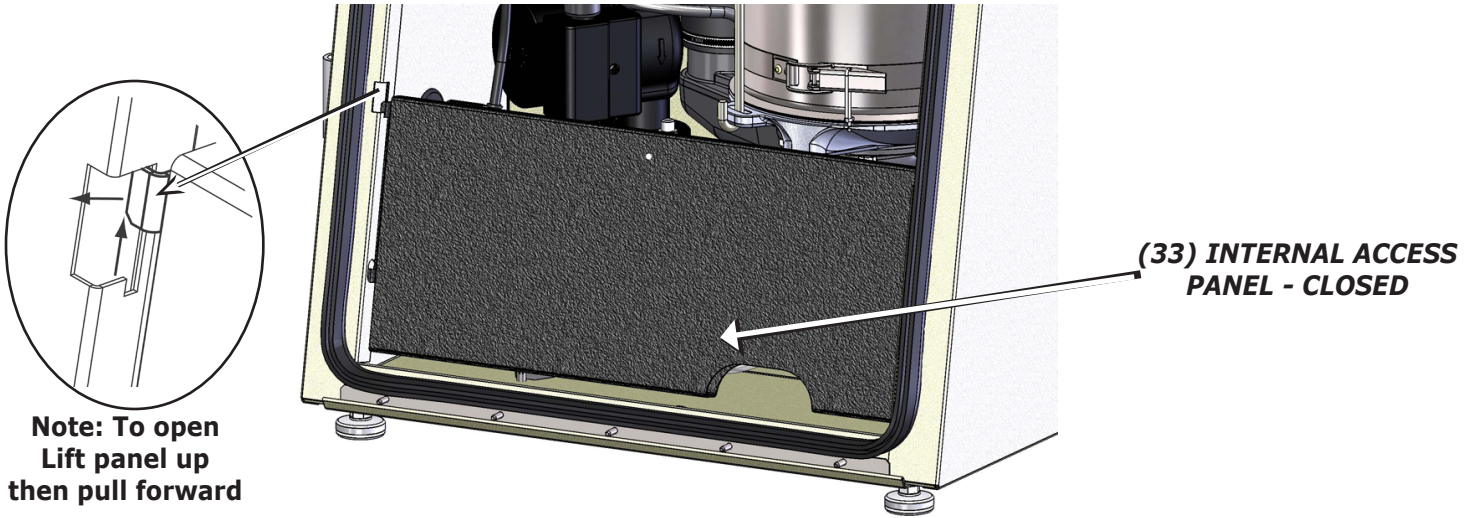

4 - LOCATING BOILER

4.1 Boiler Location Considerations

- Ambient room temperature always above 32°F (0°C) to prevent freezing of liquid condensate.
- Approved for installation in closets and on combustible floors. Do not install boiler on carpeting.
- Protection of gas ignition system components from water (dripping, spraying, rain, etc.) during operation and service (circulator replacement, condensate trap, control replacement, etc.).
- Floor or wall mounting.
 - Wall must be plumb and capable of supporting boiler weight plus 60 lbs (28 kg). See Table 1.
 - Floor must be level. Leveling feet allow adjustment up to 1/4" (6 mm).
 - Wall mounting. See section 4.3.
- Access to outdoors to meet minimum and maximum pipe lengths for combustion air and vent piping. See section 6.
- Disposal of condensate. See section 6.
- Drainage of water (or water - antifreeze solution) during boiler service or from safety relief valve discharge. See section 5.
- Access to system water piping, gas supply, and electrical service. See sections 5, 7 and 8.
- Clearances to combustible materials and service clearances. See Table 2 and figure 4-1.
- Multiple Boilers can be placed side by side, back to back or wall mounted.

TABLE 2: BOILER CLEARANCES

Dimension	Combustible Materials ⁽¹⁾	Service ⁽¹⁾⁽²⁾
Top (A)	0" (0 cm)	14" (36 cm)
Left Side (B)	6" (16 cm)	6" (16 cm)
Right Side (C)	0" (0 cm)	1½" (4 cm)
Front (D)	0" (0 cm)	6" (16 cm)
Back (E)	0" (0 cm)	0" (0 cm)
Bottom (F)	0" (0 cm)	0" (0 cm) Floor
		12" (32 cm) for Bottom Piped
Combustion Air/Vent piping	0" (0 cm)	6" (16 cm)
Hot Water Piping	See local code	6" (16 cm)

⁽¹⁾ Required distances measured from boiler.

⁽²⁾ Service, proper operation clearance recommendation.

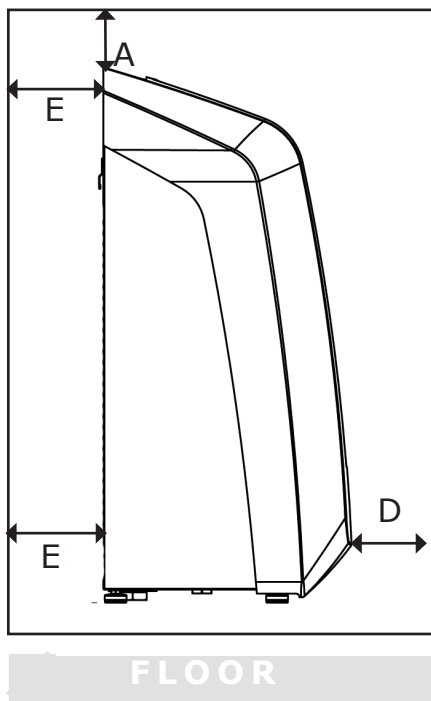
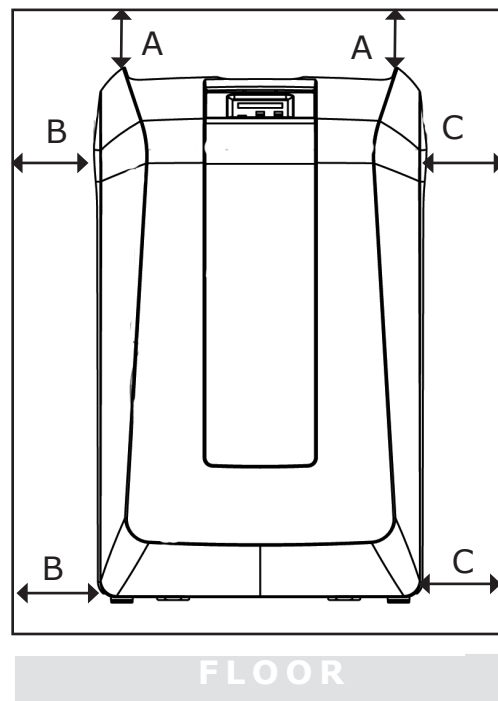

FIGURE 4-1 Clearance to Combustible Materials



4 - LOCATING BOILER

FIGURE 4-2 Wall Mount Bracket Engaged with Bracket on Boiler

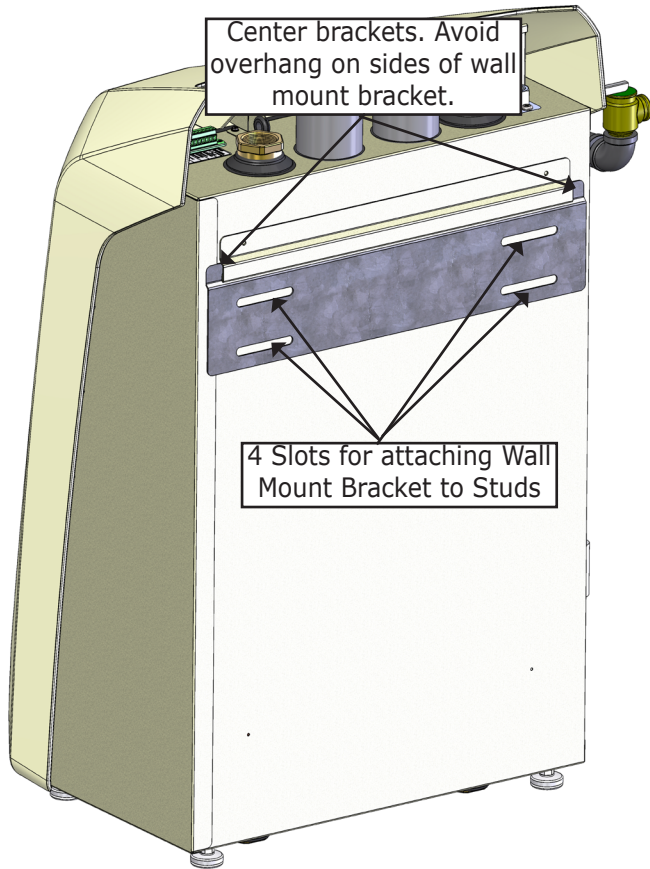
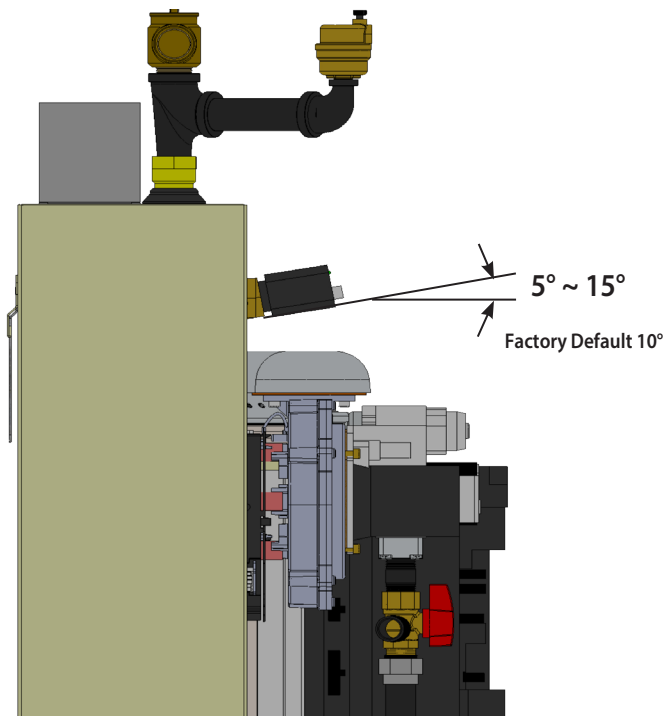

FIGURE 4-3 Low Water Cutoff Orientation



4.2 Pre-pipe supply and return water connections with factory fittings before wall mounting.

4.3 Wall Mounting

Mount boiler on wall using wall mounting bracket included with unit.

- Structure must be capable of supporting boiler weight plus 60 lbs (28 kg). See Table 1, page 2.
- Wall mount bracket has 4 slots allowing mounting on two (2) wall studs spaced at 11½" to 16½" on center. See figure 4-2.
- Boiler includes (4) 3/8" x 3" lag screws and (4) washers for attaching wall mount bracket to wood studs. Field source appropriate fasteners for other wall constructions (masonry, concrete).
- Attach wall mount bracket level on wall.
- Boiler must engage with wall mount bracket.
- Avoid overhang on sides of wall mount bracket. Verify boiler bracket is centered on wall bracket. See figure 4-2.

⚠ WARNING

Fire, explosion hazard. Mount boiler vertically or slightly tilted backward to insure proper function of low water cutoff. Failure to follow these instructions could result in death or serious injury.

- When mounting boiler onto wall insert two plastic stoppers and two plastic plugs to packaging holes on back of boiler.
- Mount boiler vertically or slightly tilted backward to insure the low water cutoff functions properly. See figure 4-3 for low water cutoff orientation.

⚠ CAUTION

Boiler weight exceeds 115 pounds (51.2 kg). Do not lift boiler onto wall without assistance.

NOTICE

Lift boiler using chassis. Using front jacket, vent piping, water or gas fittings to lift boiler may cause damage to the boiler.

5 - HYDRONIC PIPING

5.1 General

- Install piping in accordance with authority having jurisdiction.

NOTICE

Use two (2) wrenches when tightening and fitting to pipe boiler's threaded fittings. Boiler's internal piping can be damaged if subjected to excessive torque.

- Support system piping and safety relief valve discharge piping. Boiler's internal piping and wall mount bracket can be damaged if subjected to excessive weight.
- Size central heating pump (and domestic hot water pump, if used) for system requirements only. Heat exchanger pump compensates for pressure drop through boiler internal piping and heat exchanger.
- Thoroughly clean and flush system before connecting to boiler.
- If oil is present in system water, use approved detergent to wash system.
- Flush system to remove any solid objects such as metal chips, fibers, or Teflon tape, etc.

5.2 Special Conditions

- System piping exposed to freezing conditions: Use inhibited propylene glycol solutions certified by fluid manufacturer for use with closed water heating system. Do not use automotive or ethylene glycol.
- Boiler installed above radiation level (or as required by authority having jurisdiction). Integral low water cutoff provided in boiler. See pages 7 & 9.
- Boiler used in connection with refrigeration system. Install piping in parallel with boiler, with appropriate valves to prevent chilled medium from entering boiler.
- System piping connected to heating coils located in air handling unit exposed to refrigerated air circulation. Install flow control valves or other automatic means to prevent gravity circulation of boiler water during cooling cycle.

5.3 Safety Relief Valve and Air Vent

NOTICE

Boiler rated at 150 psig (1.03 MPa) maximum allowable working pressure. Boiler provided with 30 psig (206 kPa) safety relief valve. Field source safety relief valve for system pressures greater than 25 psig. Temperature Pressure Gauge satisfactory for 60 psig operation. Field source temperature pressure gauge for system pressures greater than 60 psig.

- Install safety relief valve and air vent using pipe fittings provided with boiler. See figure 5-1
- Install safety relief valve with spindle in vertical position.
- Do not install shutoff valve between boiler and safety relief valve.

WARNING

- Poison hazard. Ethylene glycol is toxic. Do not use ethylene glycol.
- Never use automotive or standard glycol antifreeze, even ethylene glycol made for hydronic systems.
- Ethylene glycol can attack gaskets and seals used in hydronic systems.
- Use only inhibited propylene glycol solutions certified by fluid manufacturer as acceptable for use with closed water heating system.
- Thoroughly clean and flush any system that used glycol before installing new Boiler.
- Provide user with ISafety Data Sheet (SDS) on fluid used.

NOTICE

Do not expose boiler and condensate piping to freezing temperatures.

FIGURE 5-1 Safety Relief Valve & Air Vent

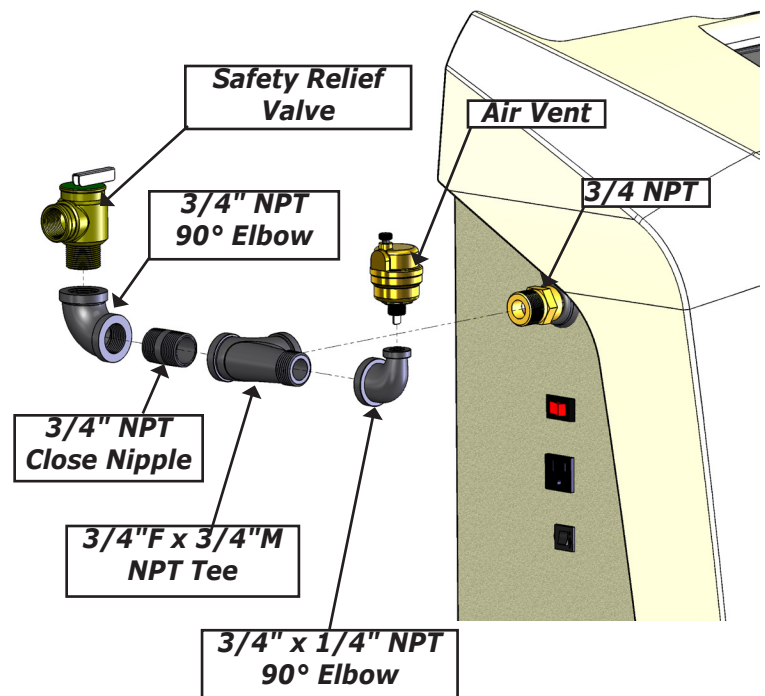

5 - HYDRONIC PIPING

⚠ WARNING

Burn and scald hazard. Safety relief valve could discharge steam or hot water during operation. Install discharge piping per these instructions.

FIGURE 5-2 Safety Relief Valve Discharge Piping

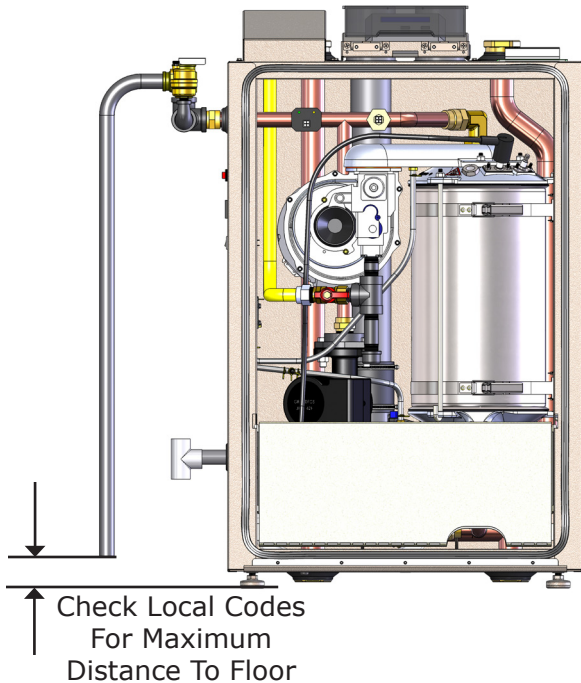
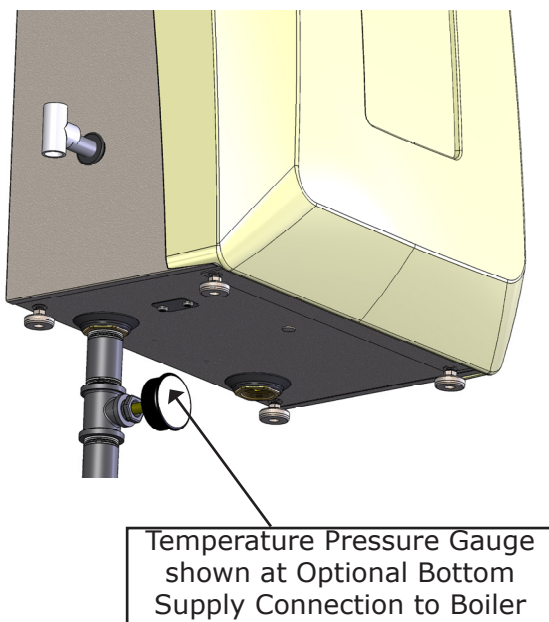

FIGURE 5-3 Temperature Pressure Gauge Installation



- Systems with automatic fill valves require back flow prevention device.
- Install discharge piping from safety relief valve. See figure 5-2.
 - Use 3/4" or larger pipe.
 - Use pipe suitable for temperatures of 375°F (191°C) or greater.
 - Individual boiler discharge piping shall be independent of other discharge piping.
 - Size and arrange discharge piping to avoid reducing safety relief valve relieving capacity below minimum relief valve capacity stated on rating plate.
 - Run pipe as short and straight as possible to location protecting user from scalding and properly drain piping.
 - Install union, if used, close to safety relief valve outlet.
 - Install elbow(s), if used, close to safety relief valve outlet and downstream of union (if used).
 - Terminate pipe with plain end (not threaded).

5.4 Trim Piping

- Supply and Return Piping
 - Supply - Select either top, bottom or both.
 - Return - Select either top, bottom, or both.
 - Use second temperature pressure gauge when piping top and bottom.
 - Install brass plug(s) provided with boiler in unused tapping(s). Use provided sealant.
- Temperature - Pressure Gauge. Install temperature pressure gauge using nipple, bushing and tee provided with boiler. See figure 5-3.

5.5 System Piping

- See Table 3 for basic system piping configurations.
- Systems with automatic fill valves require back flow prevention device.
- Single boiler system. See figures 5-4, 5-5, 5-6, 5-7 for general guidance. Additional considerations:
 - Boiler control is designed for single central heating pump. Installer responsible for integration of multiple central heating pumps.
 - Boiler control allows domestic hot water prioritization. Function could be lost if central heating pump not directly connected to control system.
- Multiple boiler system. See figure 5-8 for general guidance. Additional considerations:
 - Control system requires equivalent water temperatures entering each boiler to properly sequence and adjust system supply temperature.
 - Install multi boiler sensor kit. See "Parts, Kits & Optional Accessories" manual for part number.
- Heating system with existing primary loop, close internal primary loop ball valve.
- Heating system without existing primary loop, leave internal primary loop ball valve open to use internal primary loop.

5 - HYDRONIC PIPING







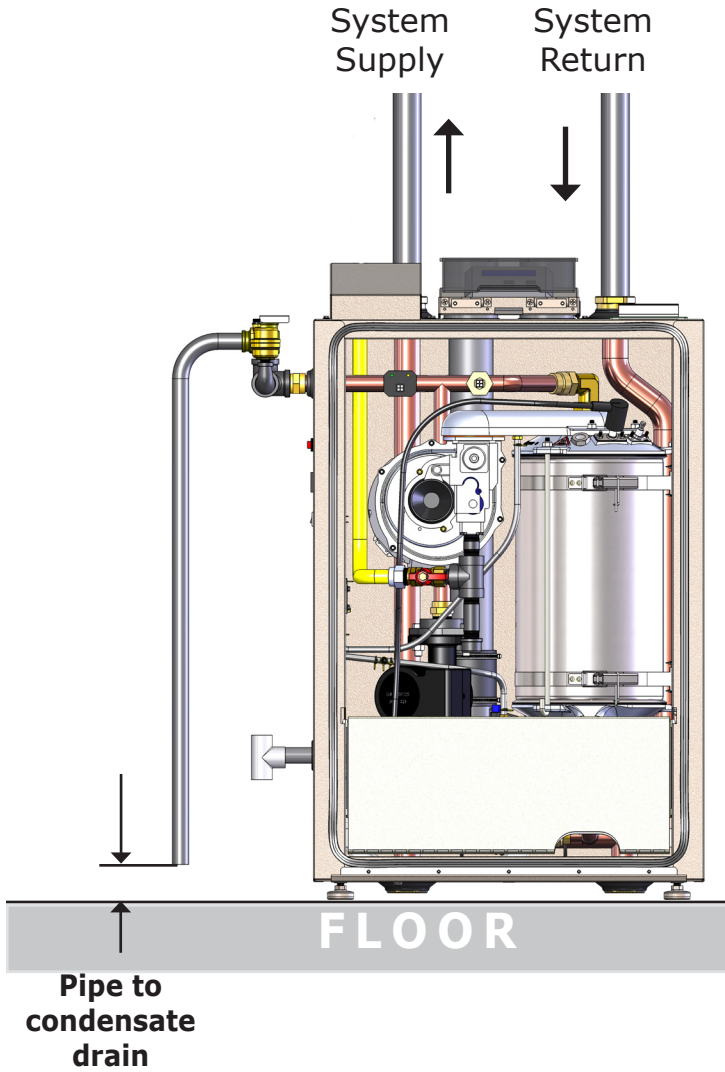

NOTICE

Illustrations are meant to show system piping concept only. Installer responsible for all equipment and detailing required by authority having jurisdiction.

FIGURE 5-4 System Piping



Piping Legend

-  Balancing valve
-  Zone valve
-  Ball valve
-  Air separator
-  Circulator
-  hose bib
-  Combination fill valve
-  Flow-check valve
-  Float type air vent

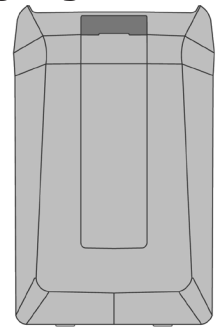

Boiler



Boiler heat exchanger

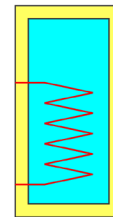

Indirect DHW tank



Diaphragm-type expansion tank

Table 3 - System Piping Configurations

Single Boiler	Two Pipe Zoned System	With Zone Valves	figure 5-5
		With Zone Pumps	figure 5-6
	Primary/Secondary Pumping	Closed External Primary Loop or	figure 5-7
		Open External Primary Loop	figure 5-7
Multiple Boilers	Typical Multiple Boiler Piping	With Zone Valves	figure 5-8
		With Zone Pumps	Not Shown
	Primary/Secondary Pumping	Closed External Primary Loop	Not Shown
		Open External Primary Loop	Not Shown

5 - HYDRONIC PIPING

FIGURE 5-5 Single Boiler Two-Pipe Zoned System With Zone Valves

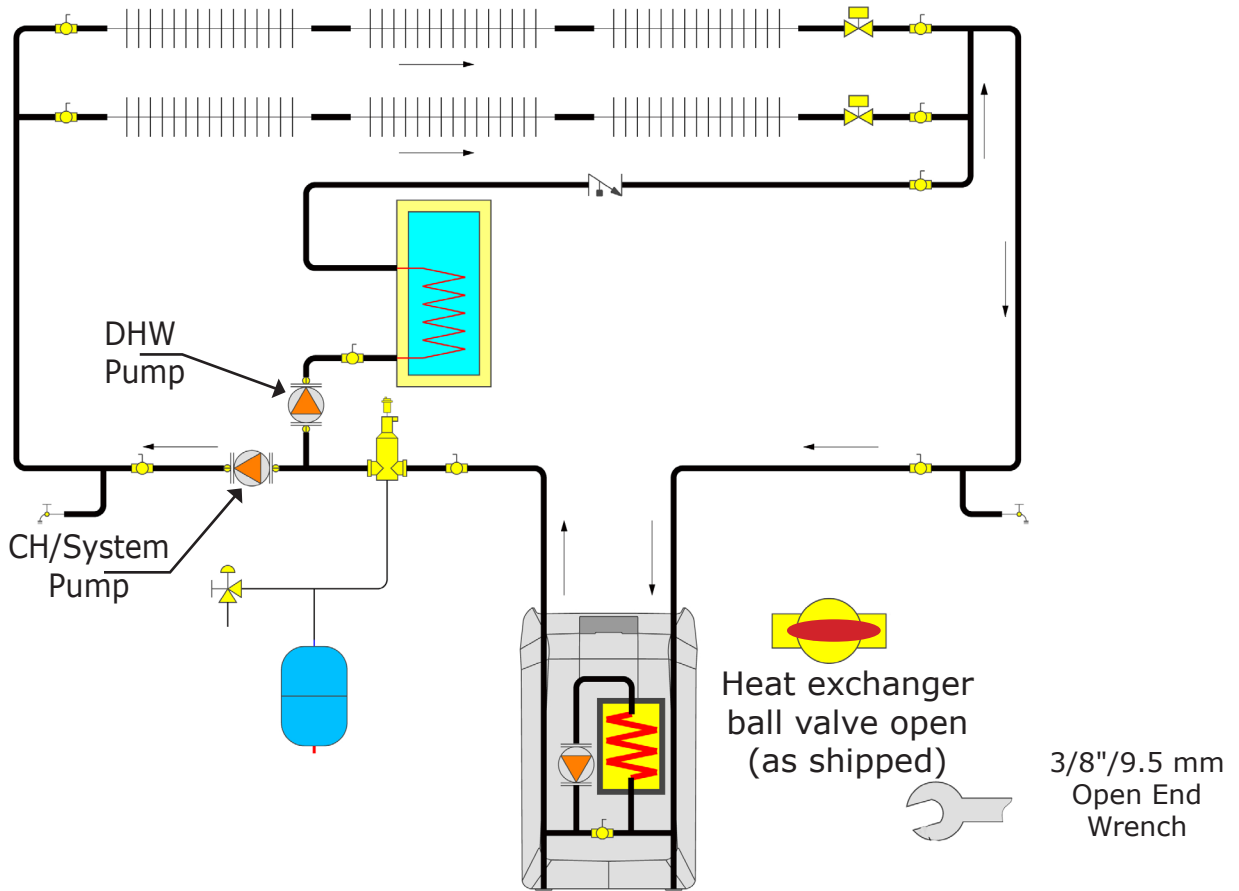
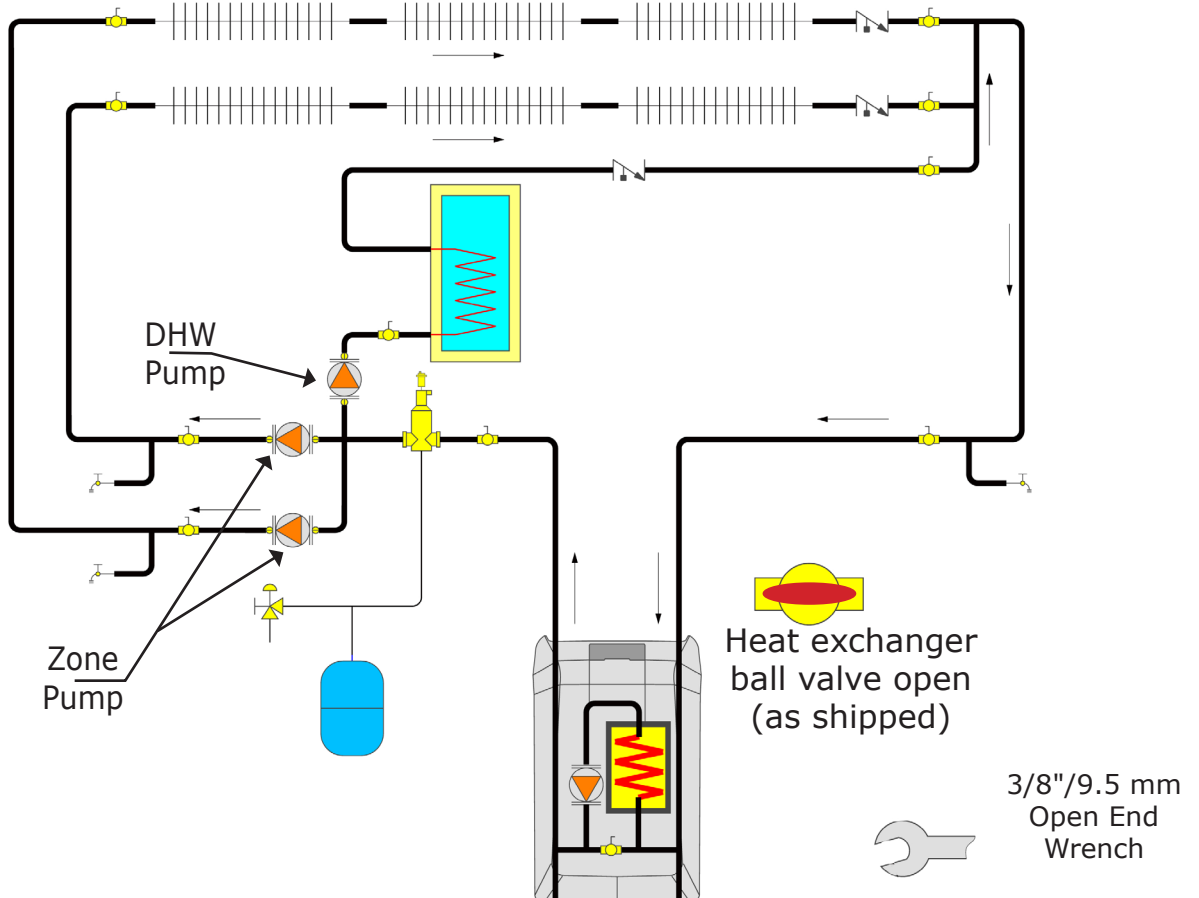
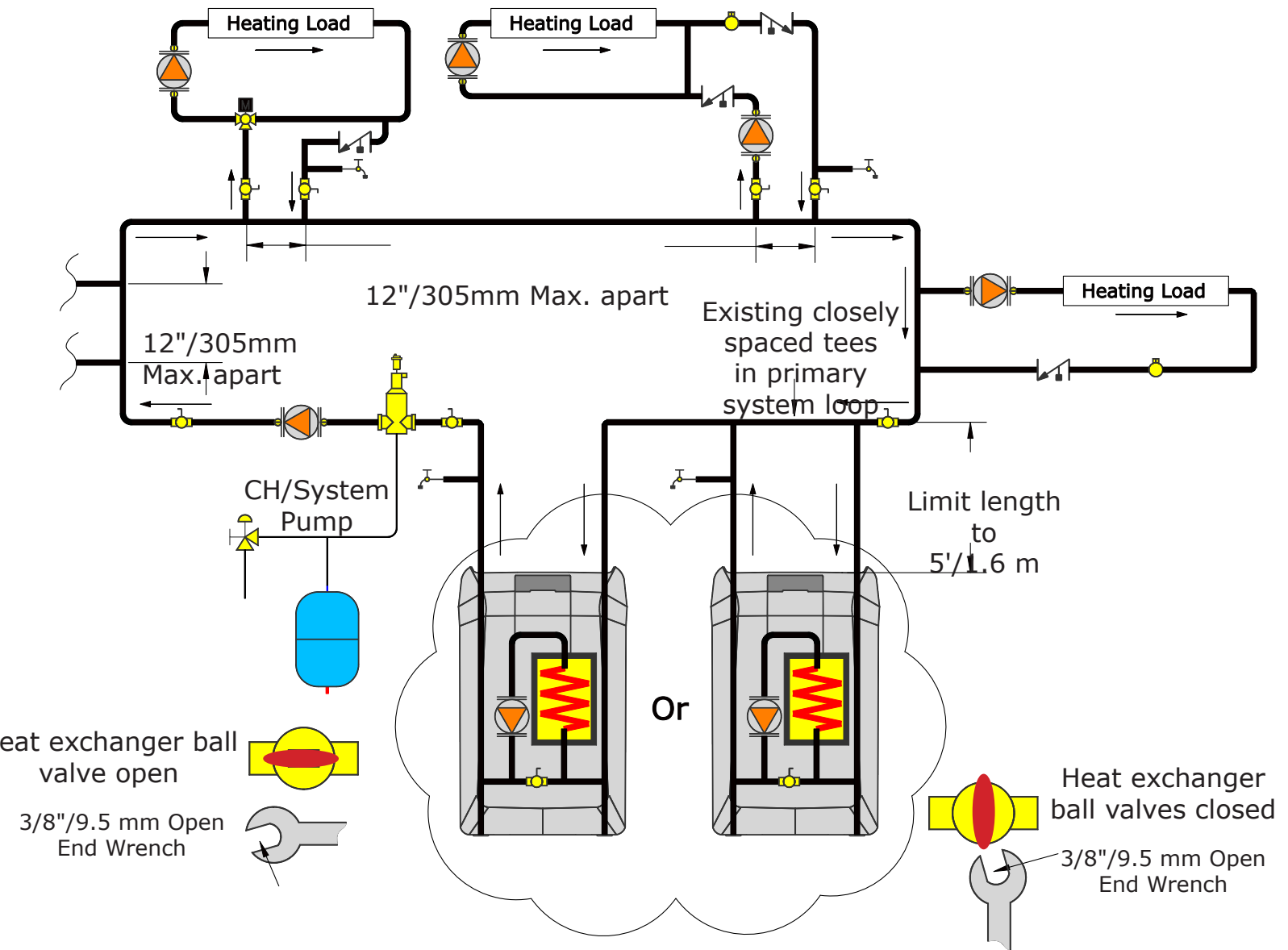

FIGURE 5-6 Single Boiler Two-Pipe Zoned System With Zone Pumps



5 - HYDRONIC PIPING

FIGURE 5-7 Single Boiler Using Primary/Secondary Pumping With Closed External Primary Loop or Single Boiler Using Primary/Secondary Pumping With Open External Primary Loop



5 - HYDRONIC PIPING

5-8 Typical Multiple Boiler Piping - (See Multiple Boiler Guide)

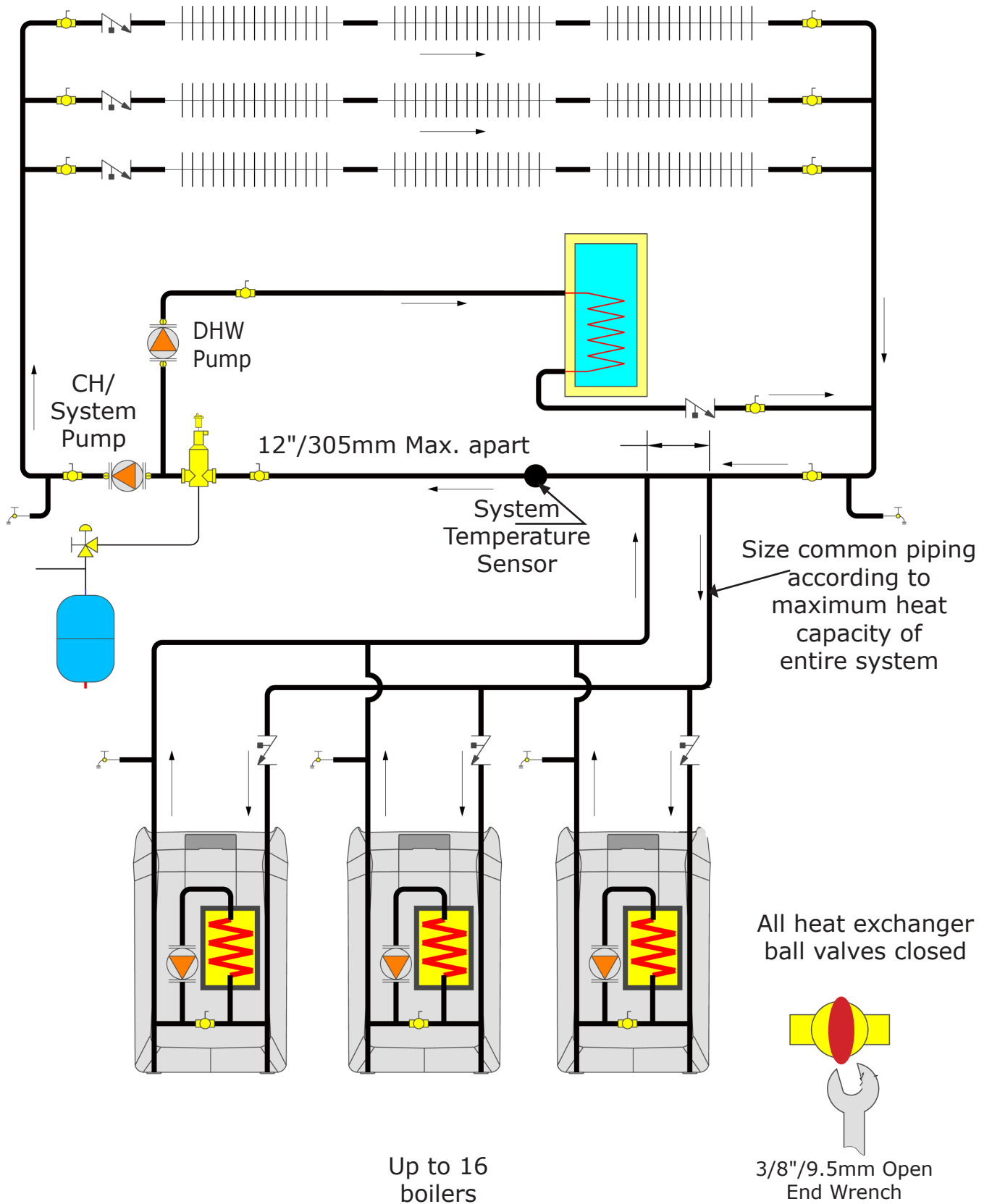

(See Multiple Boiler Guide)

6 - COMBUSTION AIR AND VENT PIPING

6.1 General

This boiler requires a dedicated direct vent system. Install combustion air and vent piping in accordance with these instructions, authority having jurisdiction, and:

- USA - National Fuel Gas Code, ANSI 223.1/NFPA 54.
- Canada - Natural Gas and Propane Installation Code, CAN/CSA B149.1

Vent connections serving appliances vented by natural draft shall not be connected into any portion of mechanical draft systems operating under positive pressure.

Install vent system in accordance with these instructions.

6.2 Removal of Existing Boiler From Common Vent System

When existing boiler is removed from common venting system, common venting system is likely to be too large for proper venting of appliances remaining connected to it.

After removal of existing boiler, following steps shall be followed with each appliance remaining connected to common venting system placed in operation, while other appliances remaining connected to common venting system are not in operation:

- Seal any unused openings in common venting system.
- Visually inspect venting system for proper size and horizontal pitch. Determine there is no blockage or restrictions, leakage, corrosion and other deficiencies which could cause an unsafe condition.
- When practical, close all building doors, windows, and all doors between space in which appliances remaining connected to common venting system are located and other spaces of building. Turn on clothes dryer and any appliance not connected to common venting system. Turn on exhaust fans, such as range hoods and bathroom exhaust so they will operate at maximum speed. Do not operate summer exhaust fan. Close fireplace dampers.
- Turn on appliance being inspected. Follow lighting instructions. Adjust thermostat so appliances will operate continuously.
- Test for spillage at draft hood relief opening after 5 minutes of main burner operation. Use flame of match or candle, smoke from cigarette, cigar or pipe.
- Determine each appliance remaining connected to common venting system properly vents when tested as outlined above. Then return doors, windows, exhaust fans and any other gas-burning appliance to their previous condition of use.

- Any improper operation of common venting system should be corrected so installation conforms with National Fuel Code, ANSI Z223.1/NFPA 54 and/or Natural Gas and Propane Installation Code, CAN/CSA B149.1. When re-sizing any portion of common venting system, common venting system should be re-sized to approach minimum size as determined using appropriate tables in Chapter 13 of the National Fuel Gas Code, ANSI Z223.1/NFPA 54 and/or Natural Gas and Propane Installation Code, CAN/CSA B149.1.

6.3 Venting Materials

- See Table 4

Table 4 - Combustion air and vent pipe fittings must conform with the following:		
Item	Material	Standards
Vent Pipe and Fittings	PVC schedule 40	ANSI/ASTM D1785
	PVC - DWV	ANSI/ASTM D2665
	CPVC schedule 40	ANSI/ASTM D1784/ F441
	SDR-21 & SDR-26 PVC	ANSI/ASTM D2241
	ABS-DWV	ANSI/ASTM D2661
	Schedule 40ABS	ANSI/ASTM F628
	PP (Polypropylene) Pipe and Components	UL 1738 ULC S636-08
Pipe Cement/ Primer	PVC	ANSI/ASTM D2564
	CPVC	ANSI/ASTM F493
	Schedule 40 ABS	ANSI/ASTM D2235
IPEX is approved vent manufacturer in Canada listed to ULC-S636.		
IPEX System 636 Cements and Primers are approved in Canada listed to ULC-S636.		
Use of cellular core PVC (ASTM F891), cellular core CPVC, or Radel® , (Polyphenolsulfone) in venting systems shall be prohibited.		

WARNING

Use of cellular core PVC for venting flue gas could result in death, serious injury.

WARNING

Covering non-metallic vent pipe and fittings with thermal insulation shall be prohibited.

6 - COMBUSTION AIR AND VENT PIPING

6.4 Pipe Installation

- Minimum and maximum combustion air and vent pipe lengths listed in Table 5. Pipe length counted from combustion air connector to termination.
- Install field-sourced 2" to 3" transition, if used, in vertical section at combustion air inlet and vent connector.
- 90° elbows equivalent to 5.0 ft (1.6 m). 45° elbows equivalent to 3.5 ft (1.1 m). 2" to 3" transition has no equivalent length.
- Slope vent pipes minimum 1/4" per foot (21 mm/m) back toward boiler. Support horizontal sections to prevent sags capable of accumulating condensate.
- Support piping in accordance with pipe manufacturer's instruction and authority having jurisdiction. In absence of manufacturer's instruction use pipe hooks, pipe straps, brackets, or hangers of adequate and strength located at intervals of 4 ft (1.2m) or less. Allow for expansion/contraction of pipe.
- Combustion air and vent piping must be air tight and water tight.
- Certified vent system components must NOT be interchanged with other vent systems or unlisted pipe/ fittings.
- Canadian installations only. All venting material, primer and glue must be listed to ULC S636.
- Canadian installations only. First 3 ft (0.9 m) of plastic vent pipe from vent connector must be readily accessible for visual inspection.

6.5 Termination

- Terminate combustion air and vent pipes with fittings or concentric vent kit.
 - See "Parts, Kits and Optional Accessory" manual for concentric vent kit part numbers.
 - Use horizontal pipe for vent and 90° elbow for combustion air termination when using fittings.
- Terminate combustion air and vent pipes in same atmospheric pressure zone when both terminals exit through the same exterior sidewall. If using T-terminal on the vent this requirement is not necessary.
- Locate combustion air termination as far as possible from swimming pool, swimming pool pump house, and other sources of airborne chlorine.
- Locate combustion air and vent as required by authority having jurisdiction.

WARNING

Vent extending through exterior wall shall not terminate adjacent to wall or below building extensions such as eaves, balconies, parapets or decks. Failure to comply could result in death or serious injury.

Table 5 - Combustion Air and Vent Piping Length

Minimum/Maximum Vent Lengths		
	2" Pipe	3" Pipe
Model	075/100	075/100
Min.	6 ft. (1.8 m)	6 ft. (1.8 m)
Max.	50 ft. (15.2 m)	100 ft. (30.5 m)

Table 6 -Equivalent Length of Venting Components

Equivalent Length of Venting Components		
Component	Feet	Meters
90° Elbow	5	1.6
45° Elbow	3 1/2	1.1
2" x 4" Adapter	0	0
3" x 4" Adapter	0	0
Concentric Vent Kit	5	1.6
Polypropylene Flexible Pipe per Foot	2 5/8	0.8

6.7 Venting Configurations

Various venting configurations can be applied to this boiler. For guidance see Venting Configuration Table 7 and corresponding figures.

NOTICE
Use of vent covers may cause freezing. If using vent covers overall vent length must be considered. Failure to heed this information may compromise operation of this boiler.

Table 7 - Venting Configurations

Flue Gas Location	Combustion Air Location	Flue Gas Terminals	Corresponding Figures
Roof	Roof	Two Pipe	figure 6-1
		Concentric	figure 6-7
	Side Wall	Single Pipe	figure 6-8
	Inside Air	Single Pipe	figure 6-9
Side Wall	Roof	Single Pipe	figure 6-10
	Side Wall	Two Pipe	figures 6-2, 6-3
		Concentric	figures 6-4, 6-5, 6-6
	Inside Air	Single Pipe	figure 6-11

6 - COMBUSTION AIR AND VENT PIPING

FIGURE 6-1

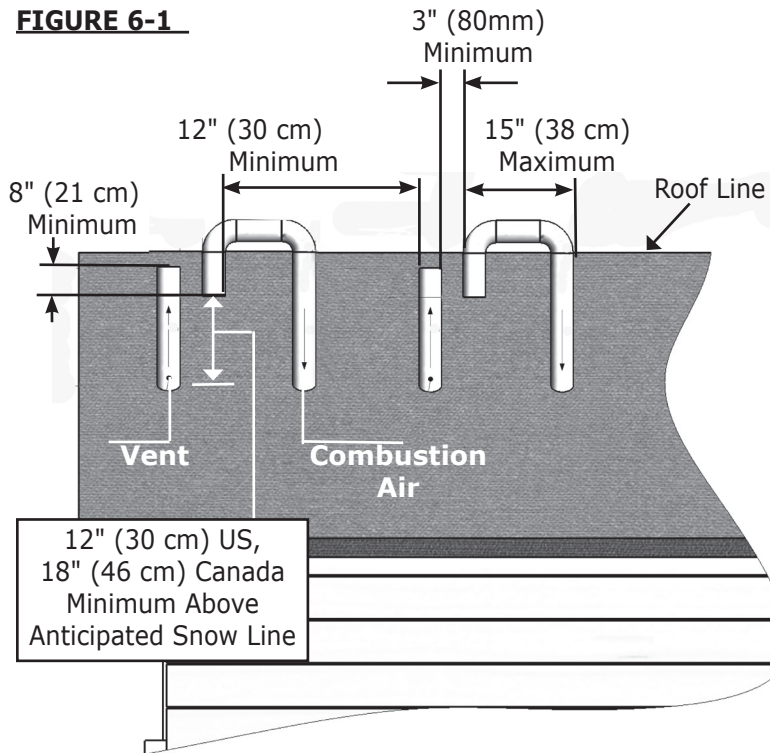

Roof Terminations

- 3" (8 cm) Minimum horizontal separation between combustion air intake and vent of same appliance.
- 8" (21 cm) Minimum vertical separation between combustion air intake and vent of different appliances.
- 15" (38 cm) Maximum horizontal length of vent.
- Minimum vent/intake between different appliances 12" (30cm).
- Maximum allowable total vertical vent length with outside exposure equals 10 ft.(3.05m).
- Abandoned unused masonry chimney may be used as chaseway for combustion air and vent. Both combustion air and vent pipe must exit above top of chimney with clearances as shown in Figure 6-1.

FIGURE 6-2

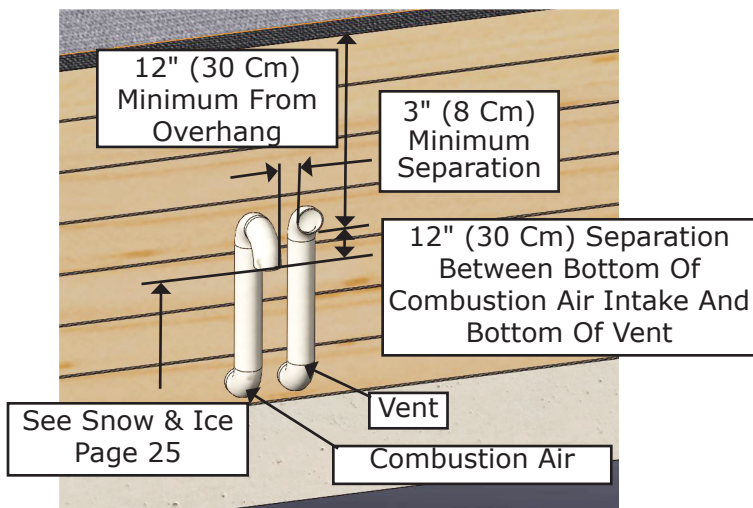

Side Wall Terminations

- 3" (8 cm) Minimum horizontal separation between combustion air intake and vent terminations.
- 8" (21 cm) Minimum vertical separation between combustion air intake and vent terminations.
- 12" (30 cm) Separation between bottom of combustion air intake and bottom of vent.
- Multiple terminations as shown in 6-1, 6-2, and 6-3 must be a minimum of 12" (30 cm) horizontally between vent of one termination and air intake of next appliance.
- Maximum allowable total outside exposure vent length equals 10 ft. (3.05m).
- Maintain a pitch of 1/2" per ft (0.15m/m) back to boiler to ensure proper condensate drainage for horizontal runs.

FIGURE 6-3

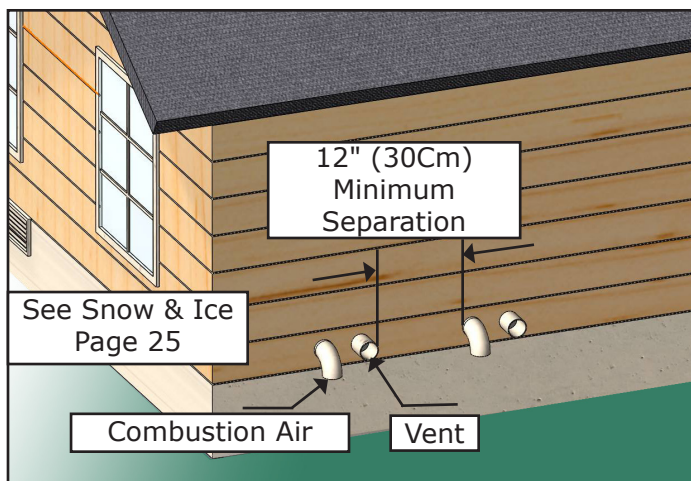

FIGURE 6-4 Side Wall Concentric Terminal

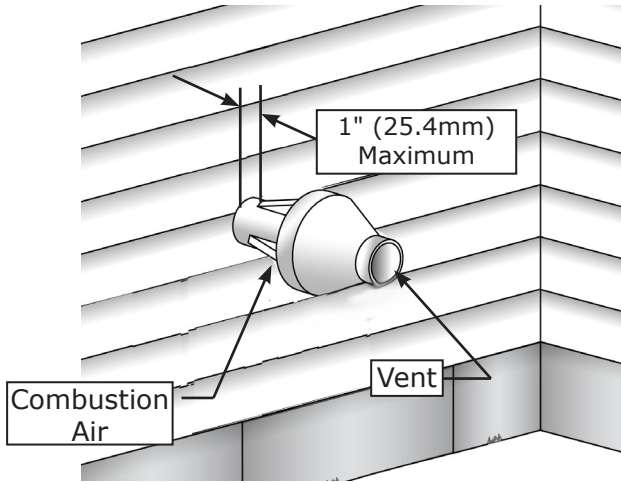
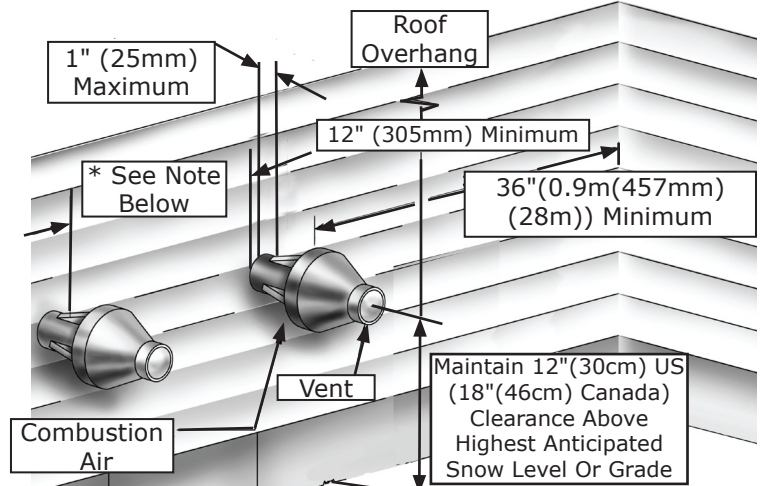

FIGURE 6-5 Side Wall Concentric Terminal Multiple Appliances



*Must be less than 4" (102mm) or greater than 24" (610mm) Horizontal distance between end bells of each air intake to prevent flue gas recirculation.

FIGURE 6-6 Concentric Terminal Connection

*2 or 3" (51 or 77 mm) Diameter PVC intake/combustion air

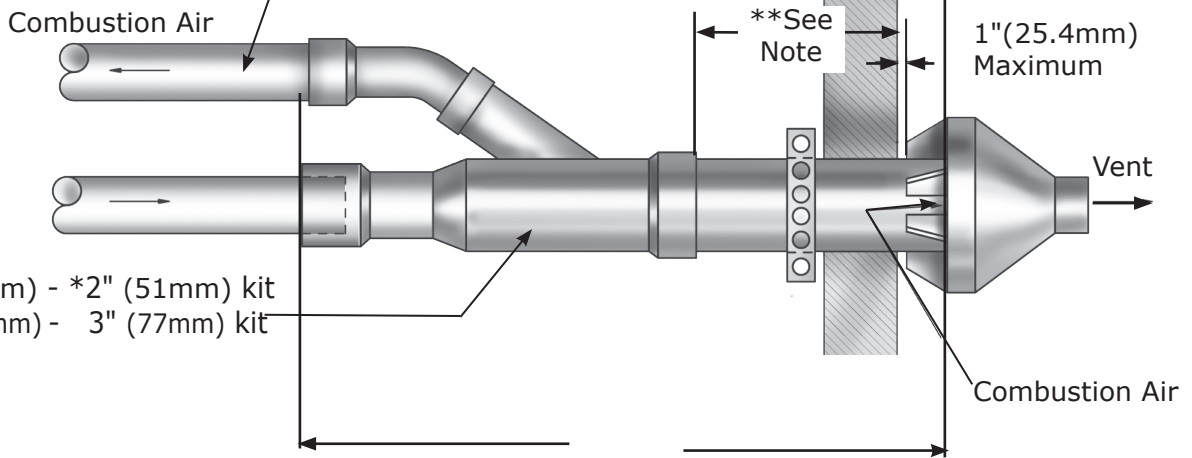

Note: Securing strap must be field installed to prevent movement of termination kit in side wall

OD 3½" (89mm) - *2" (51mm) kit
OD 4½" (114mm) - 3" (77mm) kit

*2" (51mm) Diameter = 41" Length (1.1m)
3" (77mm) Diameter = 47" Length (1.2m)

** Note Overall length may be modified by cutting or extending both combustion air and vent pipes. 12" (305mm) is minimum allowable length and 60" (1.2m) is maximum allowable length for this dimension.

SDR-26 PVC (D2241) only may be used for extending pipes. Do not use Schedule 40 PVC or use couplings to extend pipes. Dimension will change if intake/vent pipes are lengthened or shortened.

*** Note: 2" (51mm) For use with models 075/100**
3" (77mm) For use with models 075/100

FIGURE 6-7 Concentric Roof Terminal

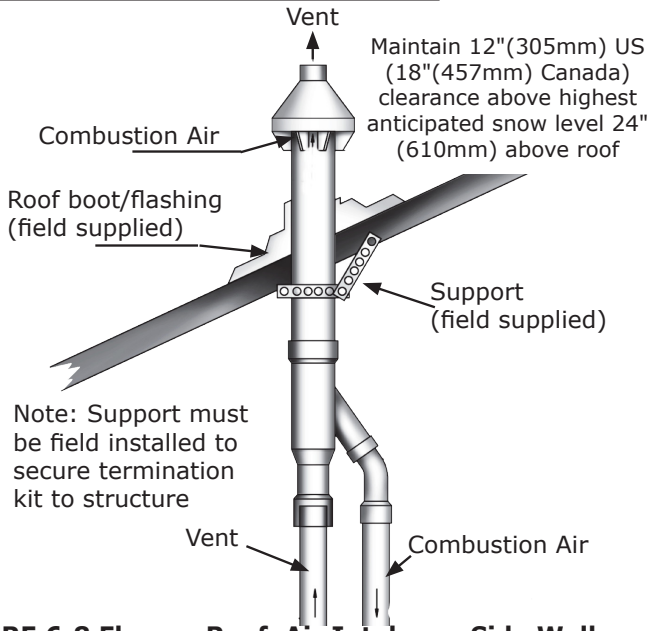

<p>Concentric Vent Roof Terminations</p>	<ul style="list-style-type: none"> • Glue inner vent pipe to prevent recirculation. • Maintain 12" (305mm) US (18" (457mm) Canada) minimum clearance above highest anticipated snow level. Maximum of 24" (610mm) above roof. • Support must be field installed to secure termination kit to structure. • Elbow, roof boot/flashing field supplied. • Allowed Wall/Roof thickness 1/2"-30" (12.7mm - 762mm). • Vertical concentric vent system can be installed in unused masonry chimney. • Contact Technical Support 800-325-5479 for questions regarding installation or use.
---	---

FIGURE 6-8 Flue on Roof, Air Intake on Side Wall

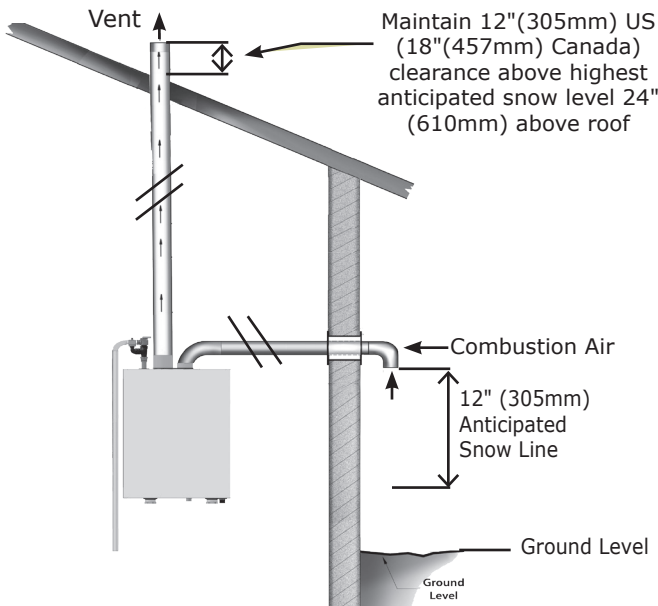

<p>Grade, Snow & Ice</p>	<p>Terminate vent system bottom, minimum 12" (300 mm) above highest anticipated snow level.</p> <p>Avoid locations where snow may drift and block vent and combustion air. Ice or snow may cause boiler to shut down if vent or combustion air becomes obstructed.</p>
-------------------------------------	--

FIGURE 6-9 Flue on Roof, Combustion Air

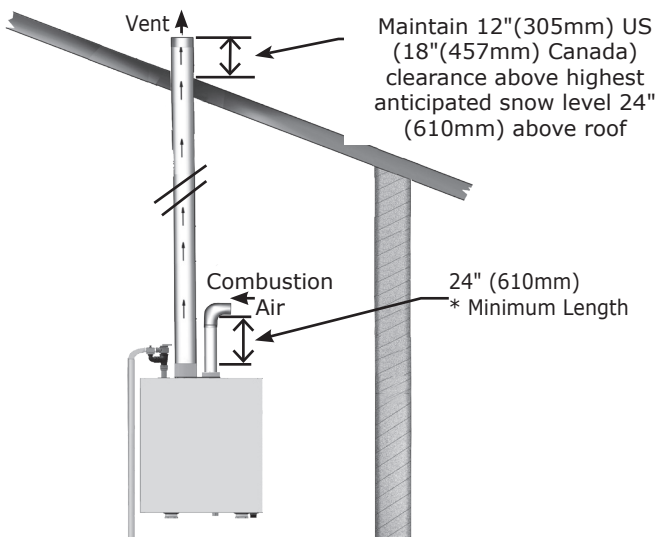

<p>Doors & Windows</p>	<p>Combustion air and vent termination must be 12" (305mm) from or below doors, windows or gravity inlet.</p>
-----------------------------------	---

<p>* See Tables 5 & 6</p>	<p>Combustion air and Vent Piping Length Page 19 .</p>
--------------------------------------	--

FIGURE 6-10 Flue on Sidewall, Combustion Air on Roof

NOTICE

Configurations of single pipe vent with flue on the sidewall, requires a tee as the vent terminal. See figures 6-10 and 6-11.

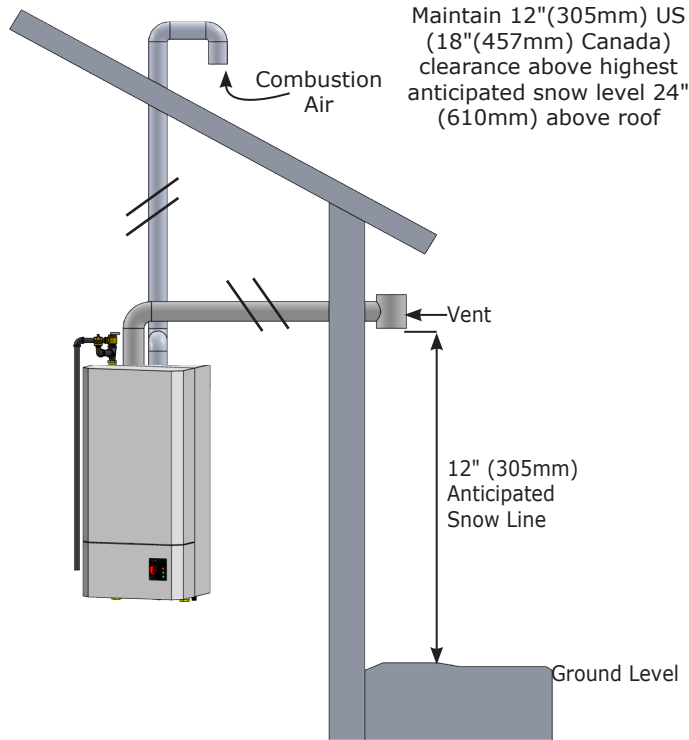
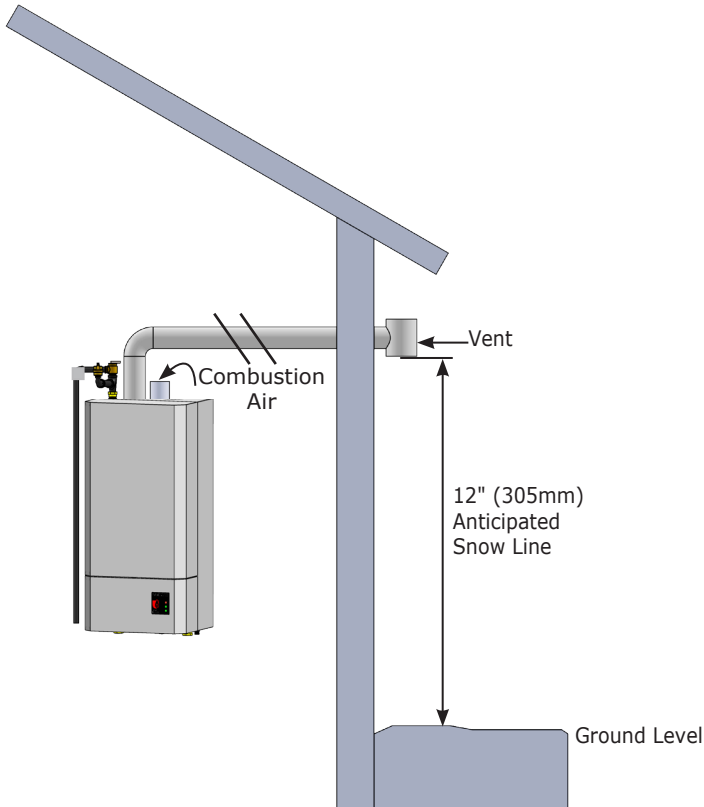

FIGURE 6-11 Flue on Sidewall, Inside Combustion Air



6 - COMBUSTION AIR AND VENT PIPING

6.8 Side Venting Terminal Requirements of :

- USA - National Fuel Gas Code, ANSI 223.1/NFPA 54.

Venting terminal from doors and windows	See figure 6-12
Venting terminal from forced air inlet of other appliances	See figure 6-13
Venting terminal from snow level	See figure 6-14
Venting terminal from vegetation	See figure 6-15
Venting terminal from public walkway	See figure 6-16

FIGURE 6-12

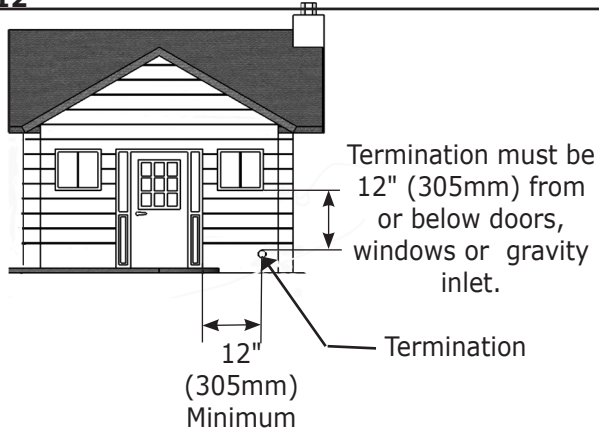

Doors & Windows	Combustion air and vent termination must be 12" (305mm) from or below doors, windows or gravity inlet.
Condensate	Vent gas may condense, forming moisture, may be corrosive. Protect building materials at vent from exhaust of vent gas.

FIGURE 6-13

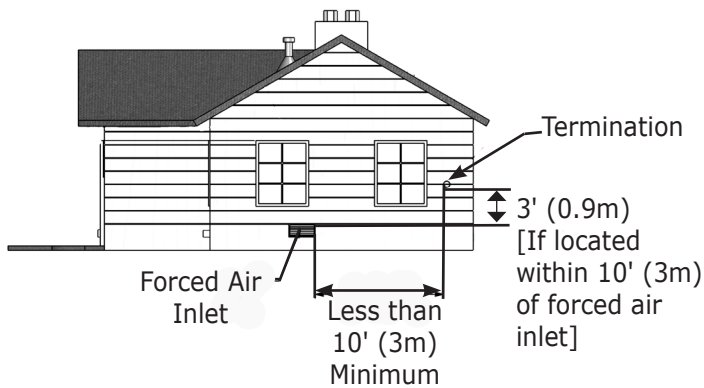

Forced Air Inlet	Terminate venting system 3' (0.9m) above and 10' (3.0m) from any forced air inlet (except boiler's combustion air inlet).
-------------------------	---

FIGURE 6-14

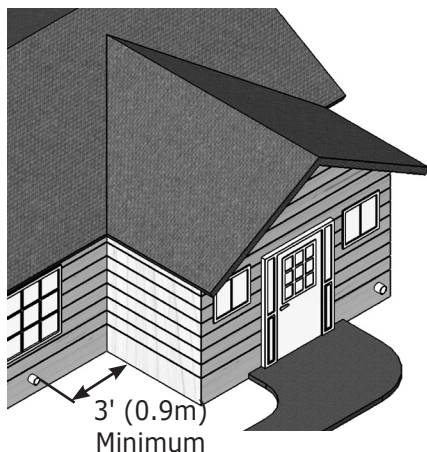

Grade, Snow & Ice	Terminate vent system bottom, minimum 12" (300 mm) above highest anticipated snow level. Avoid locations where snow may drift and block vent and combustion air. Ice or snow may cause boiler to shut down if vent or combustion air becomes obstructed.
"L" Corner	Vent termination shall NOT be installed closer than 3' (0.9m) from inside corner of "L" shaped structure.

6 - COMBUSTION AIR AND VENT PIPING

FIGURE 6-15

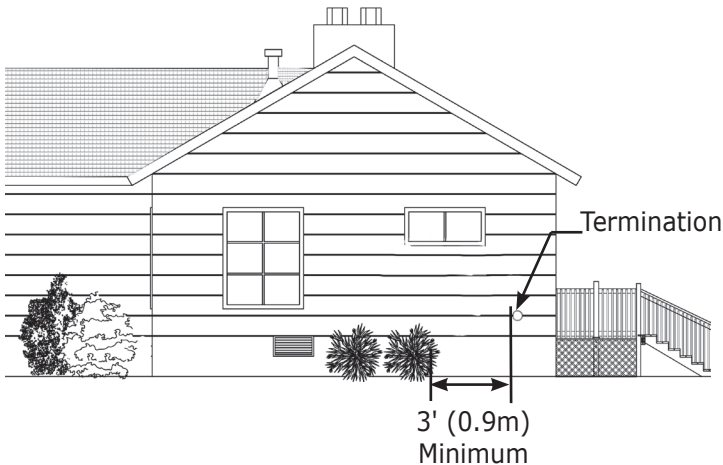

Vegetation, Plants & Shrubs	Keep vent termination 3' minimum (0.9m) away from vegetation. Position termination where vent vapors will not damage plants/shrubs or air conditioning equipment.
--	---

Meters, Regulators, deck, porch	Vent termination US only - 4' (1.2m), Canada - 6' (1.9m) horizontally from, no case above or below, electric meters, gas meters, regulators, and relief equipment, or under deck or porch.
--	--

FIGURE 6-16

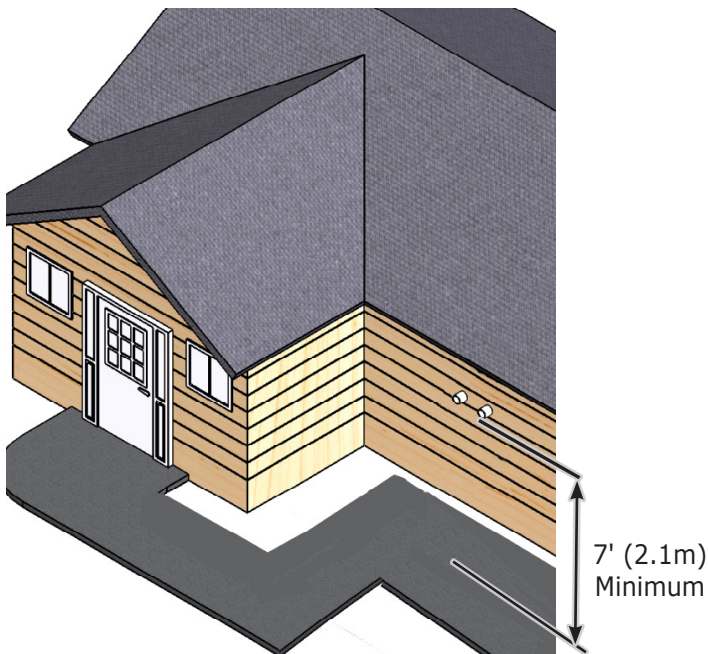

Walkways	Locate vent termination minimum 7' (2.1m) above any public walkway, with consideration to condensate.
-----------------	---

People or Pets	Locate combustion air and vent termination to prevent accidental contact with people or pets.
-----------------------	---

Stones, Balls, Etc.	Position combustion air and vent termination where it will NOT be damaged by foreign objects, such as stones, balls, etc.
----------------------------	---

Multiple Family Dwellings	Vent shall not terminate directly above paved sidewalk or paved driveway located between two single-family dwellings serving both dwellings.
----------------------------------	--

Vapors	Position termination where vent vapors are not objectionable.
---------------	---

Eddy, Flue Gases	Position termination so it will not be effected by wind eddy, air born leaves, snow, or recirculated vent gases. Give consideration to excessive wind and locate away from windward side of building.
-------------------------	---

6 - COMBUSTION AIR AND VENT PIPING

FIGURE 6-17 Condensate Drain



PVC Tee (Field Installed)
On Condensate Drain Pipe

6.9 Condensate Piping

- Use materials acceptable to authority having jurisdiction. In absence of such authority:
 - USA - PVC or CPVC per ASTM D1785/D2845 Cement or primer per ASME D2564 or F493.
 - Canada - CSA or ULC certified PVC/CPVC pipe, fittings and cement.
- Insert 1/2" (1.3 cm) PVC pipe through grommet in chassis. See figure 3-2.
- Attach PVC tee provided with boiler and field sourced piping to condensate drain vertical tee on left side of boiler. See figure 6-17.
- Slope condensate drain pipe minimum 1/4" per foot (21mm/m) away from boiler.
- Use condensate pump if boiler located below disposal point. 120 VAC auxiliary power outlet can be used to power condensate pump.
- Field source condensate neutralizing kit as required by authority having jurisdiction or for environmentally friendly condensate disposal.

7 - GAS SUPPLY PIPING

7-1 Gas Connection Knockout Plate at Bottom of Boiler

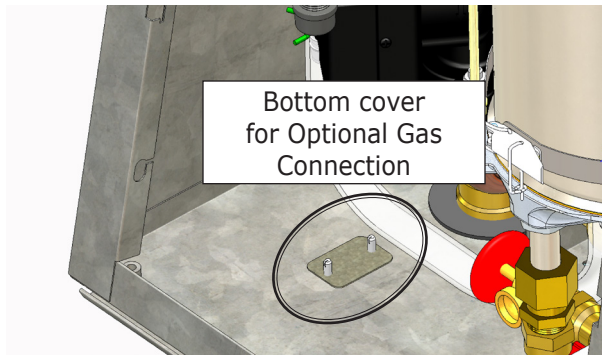

7-2 Gas connection at Top of Boiler

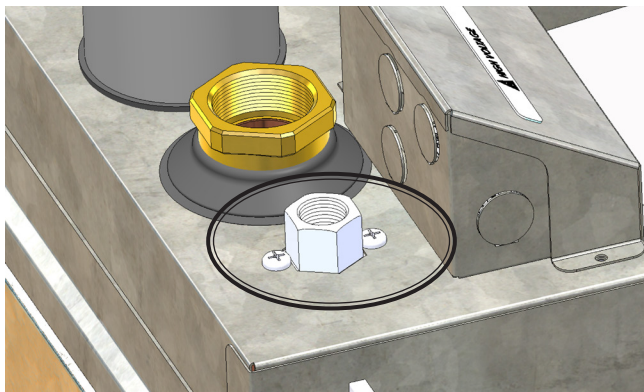

7-3 Bottom Gas Connection

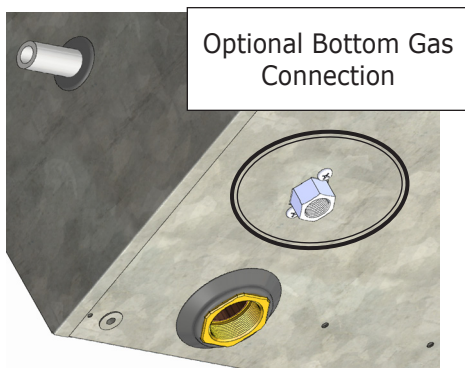

⚠ CAUTION

WHAT TO DO IF YOU SMELL GAS

- Do not try to light any appliance.
- Do not touch any electrical switches; do not use any phones in your building.
- Immediately call your gas supplier from a neighbor's phone. Follow gas supplier's instructions.
- If you cannot reach your gas supplier, call the fire department.

NOTICE

Use two (2) wrenches when tightening and fitting to pipe boiler's threaded fittings. Boiler's internal piping can be damaged if subjected to excessive torque.

7.1 General

- Use piping materials and joining methods acceptable to authority having jurisdiction. In absence of such requirements:
 - USA - National Fuel gas Code, ANSI Z223.1/NFPA 54
 - Canada - Natural Gas and Propane Installation Code, CAN/CSA B149.1
- Size and install gas piping system to provide sufficient gas supply to meet maximum input at not less than minimum supply pressure. See Table 8.
- Support piping with hooks straps, bands, brackets, hangers, or building structure components to prevent or dampen excessive vibrations and prevent strain on gas connection. Boiler will not support piping weight.
- Use thread (joint) compound (pipe dope) suitable for liquefied petroleum gas.
- Provide sediment trap up stream of gas valve.

7.2 Conversion Kit Instructions

- See Gas Conversion Kit Instructions included with Boiler.

TABLE 8: GAS SUPPLY PRESSURE

SIZE	Maximum Input (Btuh)	Natural Gas		Propane	
		Min.	Max.	Min.	Max.
075/100	75,000	3.0" w.c. (0.7 kPa)	13.5" w.c. (3.3 kPa)	5.0" w.c. (1.2 kPa)	13.5" w.c. (3.4 kPa)

Note: See Glossary - Piping Table 16

7 - GAS SUPPLY PIPING

⚠ DANGER

Fire Hazard. Do not use matches, candles, open flames, or other methods providing ignition source. Failure to comply will result in death or serious injury.

7.3 Near Boiler Gas Piping

- Select top or bottom gas connection. To convert from top connection to bottom connection:
 - Remove bottom knockout by removing two (2) screws. See figure 7-1.
 - Disconnect gas connection by removing two (2) screws. See figure 7-2.
 - Relocate gas connection to bottom opening. Secure with two (2) screws. See figure 7-3.
 - Relocate knockout cover to top opening. Secure with two (2) screws. See figure 7-4.
- Install field sourced manual main shutoff valve and ground joint union. See figure 7-5.

7.4 Leak Check Gas Piping

Pressure test boiler and gas connection before placing boiler in operation.

- Pressure test over 1/2 psig (3.5 kPa). Disconnect boiler and its individual gas shutoff valve from gas supply system.
- Pressure test at 1/2 psig (3.5 kPa) or less. Isolate boiler from gas supply system by closing manual gas shutoff valve. See figure 7-6.
- Locate leakage using gas detector, noncorrosive detection fluid, or other leak detection method acceptable to authority having jurisdiction. Do not use matches, candles, open flames, or other methods providing ignition source.
- Correct leaks immediately and retest.

7-4 Gas Connection Knockout Plate at Top of Boiler

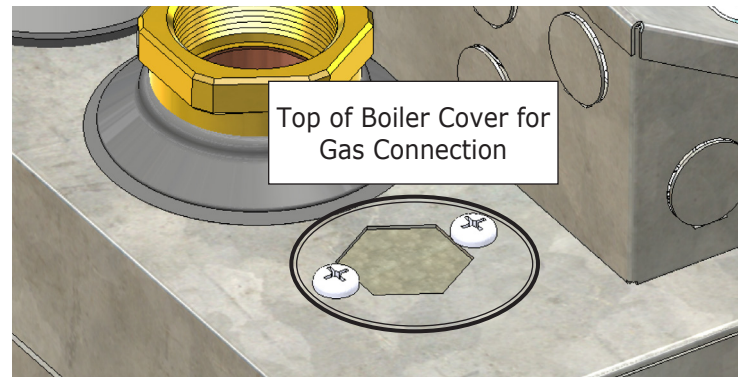

7-5 Manual Main Gas Shutoff Valve Outside Boiler Jacket

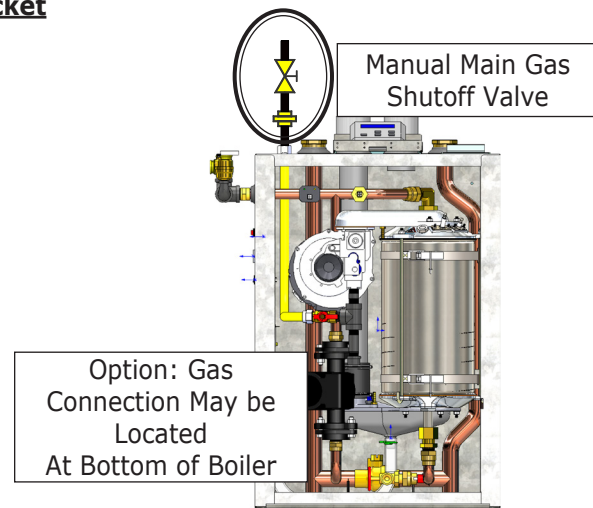

7-6 Gas Shutoff Valve

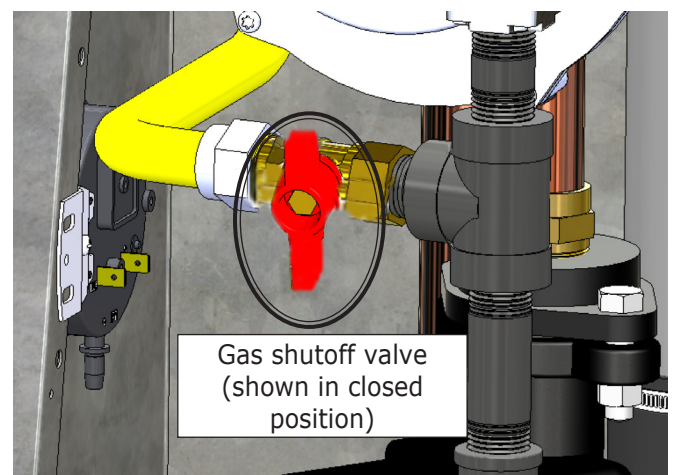

8 - ELECTRICAL CONNECTIONS

8.1 General

Electrically bond boiler to ground in accordance with requirements of authority having jurisdiction. Refer to:

- USA- National Electrical Code, ANSI/NFPA 70.
- Canada - Canadian Electrical Code, Part I, CSA C22.1: Safety Standard for Electrical Installations.

8.2 Line Voltage Connections (Figure 8-1)

• Boiler

- A. Provide individual 120V, 15 amp circuit (recommended) with fused disconnect or service switch, as required by authority having jurisdiction.
- B. Open High Voltage Junction Box (see Figures 3-1, 3-2) to access line voltage terminal strip.
- C. Connect 120 VAC circuit to line voltage terminal strip 120 VAC L,N,G.

• Central Heating Pump, if used.

- A. Isolate pump from control module if pump FLA (Full Load Amps) exceeds 5 amps.
- B. Connect pump to line voltage terminal strip CH PUMP L,N,G.

• Domestic Hot Water Pump, if used.

- A. Isolate pump from control module if pump FLA exceeds 1.0 amp.
- B. Connect pump to line voltage terminal strip DHW PUMP L,N,G.

8.3 External Connections (Figure 8-2)

• User Interface Terminals

- A. Factory wired to low voltage terminal plug USER INTERFACE terminals
- B. Optional - Remote mount user interface for improved access.
- C. Maximum wire length is 100 ft (30m) for 22 ga. wire, or 150 ft (45m) for 18 ga. wire.

• Argus Link (Multiple boiler applications only)

⚠ WARNING

Electrical shock hazard. Turn OFF electrical power supply at service panel before making electrical connections. Failure to do so could result in death or serious injury.

NOTICE

Wiring diagrams can be found in Section 14 of this Manual.

8-1 LINE VOLTAGE CONNECTIONS

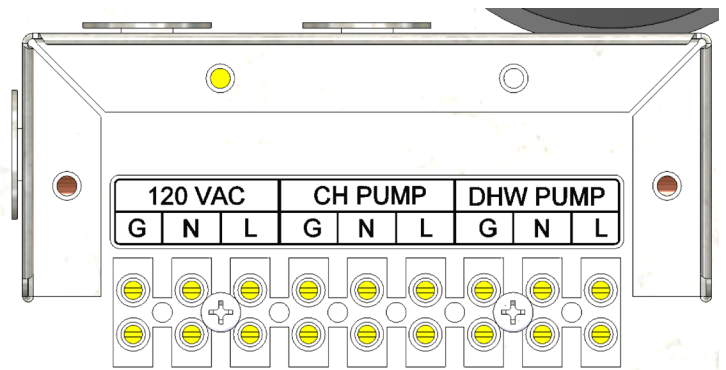

8-2 EXTERNAL CONNECTIONS

(Do not apply external voltage to external terminals.)

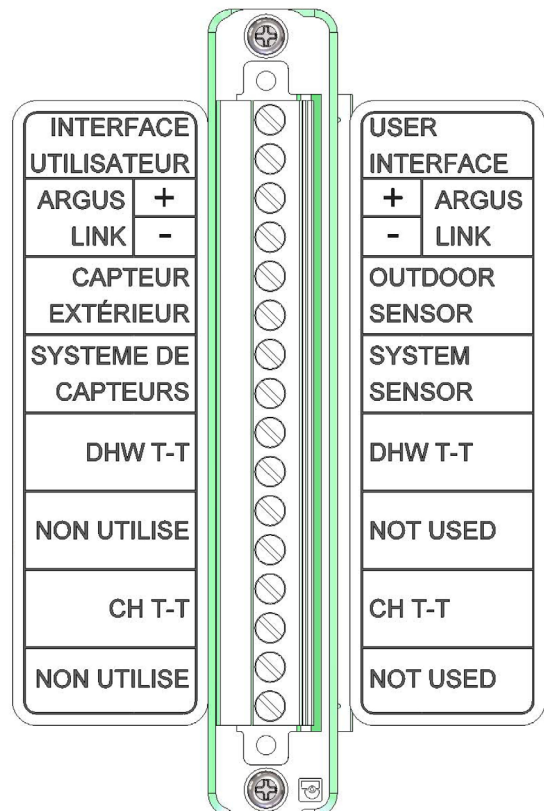

8 - ELECTRICAL CONNECTIONS

● **Outdoor Sensor, if used.**

- A. Provided with boiler in accessory kit.
- B. Locate outdoor sensor to protect against wind and direct sunlight. Mounting instructions provided with sensor.
- C. Maximum wire length is 100 ft (30m) for 22 ga. wire, or 150 ft (45m) for 18 ga. wire.
- D. Connect wires to low voltage terminal plug OUTDOOR SENSOR terminals. Wires are interchangeable.

● **System Sensor (Multiple boiler applications only)**

● **Domestic Hot Water (DHW) Thermostat, if used.**

- A. Use temperature control with dry contacts rated at 0.5 amps @ 120 VAC. Boiler control does not provide power to DHW temperature control.

NOTICE

Do not apply power to DHW T-T terminals. Dry contact only, use of isolation relay may be necessary.

- B. Maximum wire length is 330 ft (100 m) 22 gauge wire.
- C. Connect wires (interchangeable) to low voltage terminal plug DHW T-T terminals. Wires are interchangeable.

● **Central Heating Thermostat**

- A. Use thermostat or boiler system control with dry contacts related 0.5 amps @ 120 VAC. Boiler control does not provide 24 VAC power to central heating thermostat.
- B. Locate and install thermostat per manufacturer's instructions. Maximum wire length is 330 ft (100 m) for 22 ga. wire.
- C. Connect wires to low voltage terminal plug CH T-T terminals. Wires are interchangeable.

NOTICE

Use dry contact for wires to CH T-T terminal and DHW T-T terminal. E33 error code is displayed if voltage is sent back to the control board. If error is not corrected for extended period of time, this voltage can permanently damage control board.

9 - START UP PROCEDURE

NOTICE

Condensate trap must be manually filled with water at initial start up.

9.1 Fill Boiler With Water And Purge Air

NOTICE

To maintain boiler efficiency and prevent boiling inside the heat exchanger, flush entire heating system until clean.

- Flush heating system, including all heating zones.
- Fill boiler with potable water.
- Fill boiler and system piping with water (or antifreeze-water solution, if used). See antifreeze information page 12. Purge air from boiler using air vent. Purge air from system piping.
- Close air vent after all air is purged from both boiler and system piping.
- Inspect system piping and boiler connections. Repair any leaks immediately.
- Activate all heating zones and calls for heat, including CH calls and DHW calls (if available).
- Close manual gas shut off valve. Let system run for 30 minutes. When boiler goes into lockout, reset boiler by pressing "Reset" button until boiler resets.
- Do not open gas shutoff valve until all air is purged from system.

9.2 Fill Condensate Trap with Water

- Disconnect collet clip from elbow. See figure 9-1.
- Disconnect tubing below elbow.
- Pour about 1 cup (237ml) of water into condensate drain.
- Reconnect tubing to elbow with collet clip. See Figure

9-1 Condensate Drain Assembly

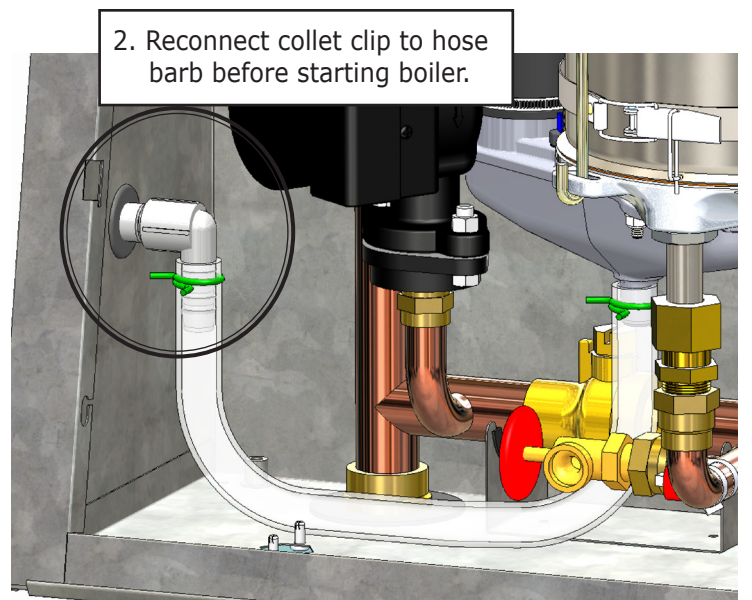
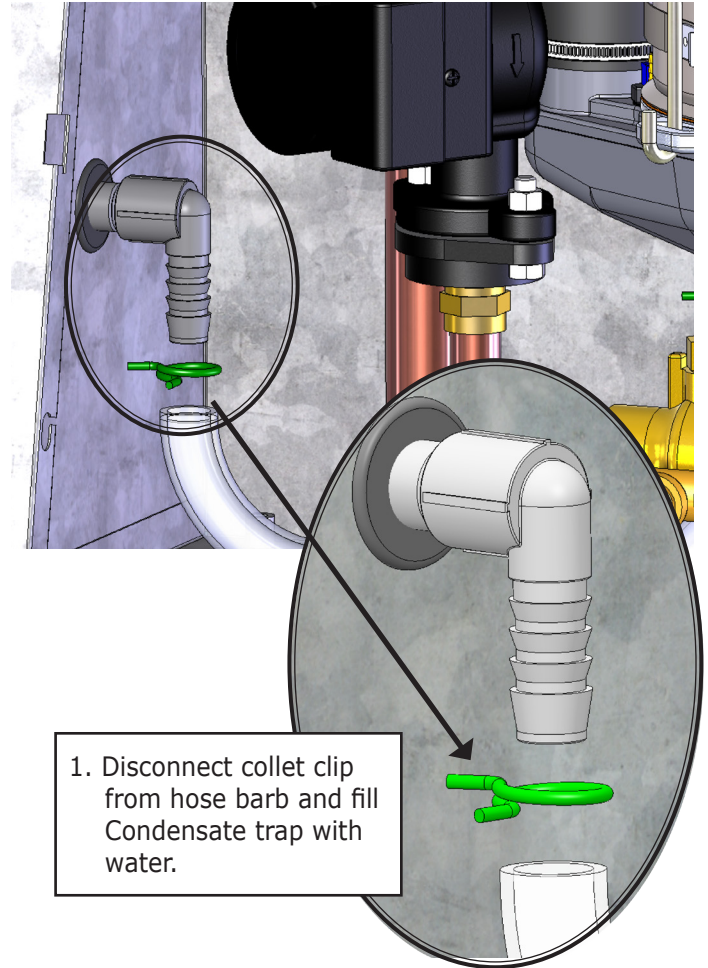

9 - START UP PROCEDURE

9 -2 User Interface

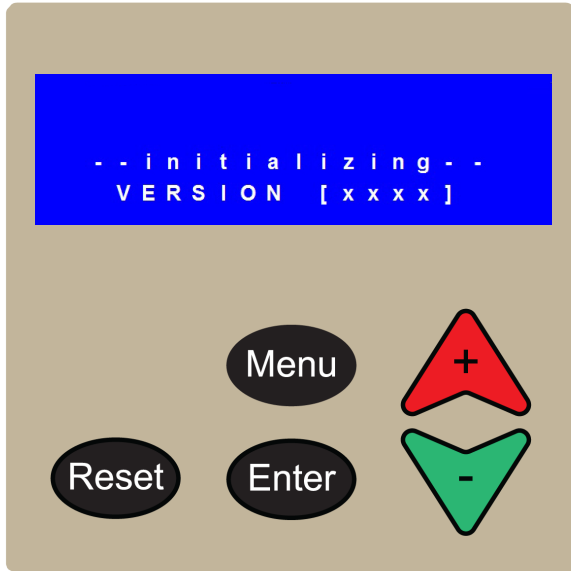

9.3 Program Boiler Control

Key	Description
	- Manual Lockout Reset
	- Enter/Exit user menu - Go to previous screen
	- Select a menu item - Confirm new parameter value
	- Scroll up to next menu item - Increase value
	- Scroll down to next menu item - Decrease value

Boiler is factory programmed with following factory default settings, Figure 9-2.

Parameters can be adjusted to suit particular application.

Detailed explanation of each can be found in Appendix A - Control Module.

List parameters in event of Control Module Failure to reprogram your settings.

9-3 Default Table		Control Parameter	Factory Default Setting		Setting Range		*Actual Parameter Settings
			Standard	Metric	Standard	Metric	
User Menu	Settings	Central Heating Setpoint	140°F	60°C	104 - 195°F	40 - 91°C	
		DHW Setpoint	180°F	82°C	104 - 195°F	40 - 91°C	
		Temperature Units	°F		°F/°C		
		Language	English		English/French		
Installer Menu	Boiler Configuration	Boiler Address	0		0-15		
		Low Water Cutoff	Enabled		Enable/Disabled		
		Pump Mode	0		0 & 4		
		Service Reminder Status	On		ON/OFF		
		Service Reminder Days	365 Days		1- 999 Days		
	CH Settings	CH Mode	1		0-3		
		Warm Weather Shutdown	70°F	21°C	35-100°F	2-38°C	
		Reset Curve Design Temperature - Boiler	180°F	82°C	60-195°F	40-91°C	
		Reset Curve Design Temperature - Outdoor	25°F	-4°C	-60-32°F	-51-25°C	
		Reset Curve Mild Weather Temperature - Boiler	70°F	21°C	35-120°F	2-49°C	
		Reset Curve Mild Weather Temperature - Outdoor	70°F	21°C	35-85°F	2-29°C	
		Reset Curve Boiler Minimum Temperature	70°F	21°C	40-180°F	4-82°C	
		Reset Curve Boiler Maximum Temperature	180°	82°C	80-195°F	27-91°C	
		Boost Function Temperature	18°F	10°C	0-36°F	0-20°C	
	Boost Function Time	20 Minutes		1-120			
Maximum Power CH	100%		1-100%				
	DHW Mode	0		0/2			
	DHW Maximum Priority Time	30 Minutes		1-60 minutes			

* List parameters in event of Control Module Failure to reprogram your settings.

9 - START UP PROCEDURE

9.4 Boiler Start-up and Operational Test

1. Verify air is purged from hydronic piping
2. System test pumps - verify each pump is operational
3. Verify gas piping
 - Confirm pressure test. See section 7.4.
 - Visually inspect piping to determine there are no open fittings or ends, and all valves at unused outlets are closed and plugged/capped.
 - Purge air from piping
 - Check piping and connections for leaks immediately after gas is turned on. Shut off gas supply and make necessary repairs if leaks found.
4. Follow OPERATING INSTRUCTIONS to initiate boiler operation. See section 10.
5. Inspect combustion air and vent piping. Verify pipe is not leaking and terminations are unobstructed and vent gas discharge is not a nuisance or hazard.
6. Verify boiler functions.
7. Inspect condensate disposal system. Verify condensate flows adequately and is disposed properly.
8. Check control module operation.
9. Check field sourced limits, low water cutoffs, etc. per manufacturer's instructions.

9.5 Check Combustion

Natural Gas

1. Measure input. English units*
 - Turn off gas to all other appliances.
 - Activate some heating zones to dissipate heat.
 - Set boiler on high fire.
 - Use ½, 1 or 2 cu ft dial on gas meter. Measure time required for one or more complete revolutions. Measure time for 1-2 minutes.
 - Calculate input.

$$\text{Input (MBH)} = \frac{3600 \times \text{___ cu ft}}{\text{___ seconds}}$$

Example: Gas flow from

Meter = 2 cu ft

Measured time = 72 seconds

$$\text{Rate (MBH)} = \frac{3600 \times 2 \text{ cu ft}}{72 \text{ seconds}} = 100 \text{ MBH}$$

*Metric - See Glossary

2. Compare measured input to table. Adjust input rate if needed using Table 12 below.

Table 12 - Rate @ High Fire

Size	Minimum	Maximum
075	65	85
100	90	102

Natural Gas and Propane

3. Measure CO₂ at high fire and compare to table. Adjust CO₂ if needed using figure 9-3 . See figure 9-5 combustion air analyzer port.

Natural Gas only**

4. Measure input. Compare to table above. Continue to measure input and CO₂ until both measured values are within range specified in tables.

9 - START UP PROCEDURE

Gas	CO ₂		CO
	Min.	Max.	
Natural Gas	9.0	9.5	<200ppm
Propane	10.0	11.0	<200ppm

NOTICE

Contact Technical Support @ 800-325-5479 for additional information or assistance.

Natural Gas only**

1. Measure input. Compare to table above. Continue to measure input and CO₂ until both measured values are within range specified in tables.

Propane Gas

Most propane systems do not have flow meters.

1. Check CO₂. Propane should be between 10% and 11.0%.
 - If CO₂ is low increase gas flow following figure 9-3 & 9-4.
 - If CO₂ is high decrease gas flow following figure 9-3 & 9-4.

FIGURE 9-3 Gas Valve - Models 075/100 MBH

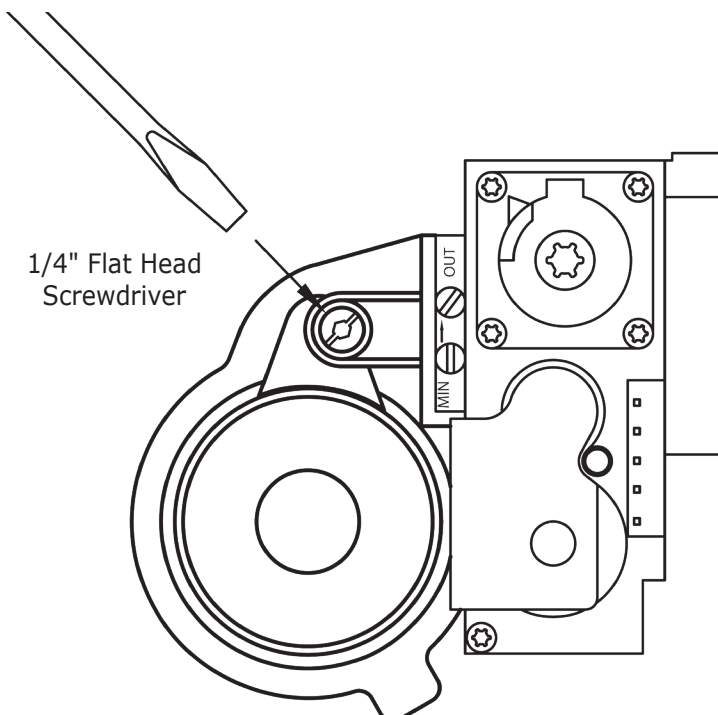

- To increase gas flow turn 'throttle' left or counter clockwise ↺.
- To decrease gas flow turn 'throttle' right or clockwise ↻.
- Limit adjustment to one turn and retest.

Verify Burner, Proper Operation

1. Inspect burner flame through Sight Glass. See figure 9-5.
2. Operate boiler through several heating cycles, including domestic hot water, if used. Verify proper operation.
3. Reset control parameters to operating settings if adjusted to allow startup and operation test.
4. Follow instructions TO TURN OFF GAS TO APPLIANCE if boiler is not being placed into immediate operation.
5. Enter installer information on Warranty Registration Card.
6. Gather all instructions, manuals, wiring diagrams, warranty registration card and other supporting information. Review with user and/or affix in conspicuous location adjacent to boiler.

9 - START UP PROCEDURE

NOTICE

Combustion analyzer port is provided. After use replace cover.

9-4 Combustion Analyzer Port

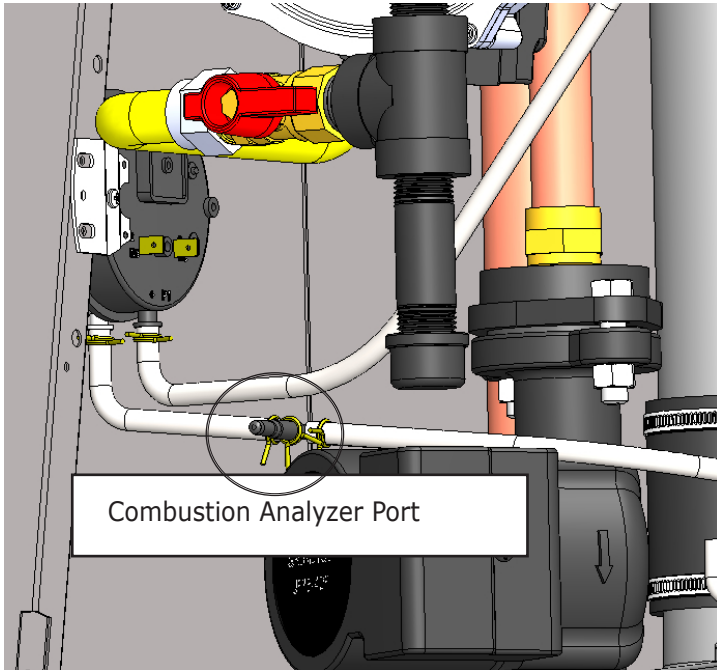

9-5 Burner Flame

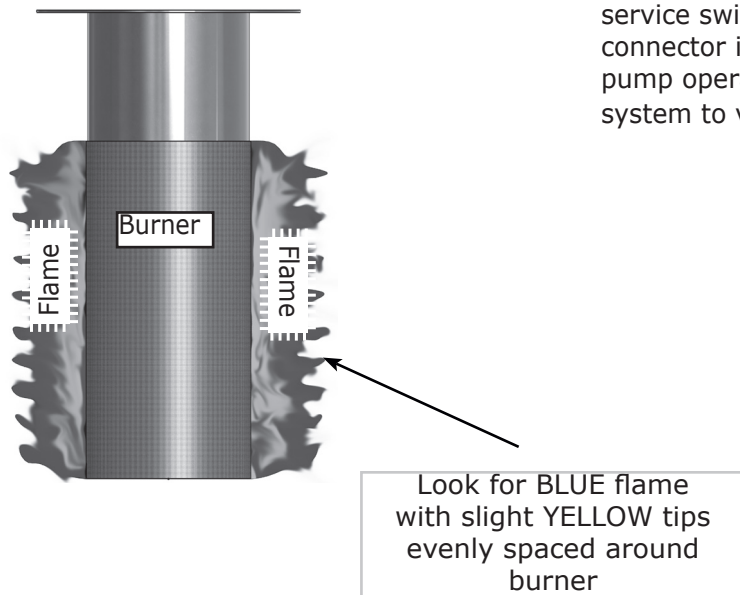

9.6 Perform CSD-1 Compliance Test (see paragraph 2.5 page 6)

Verify operation of boiler safety control operation with regard to no flow conditions as follows:

1. Turn off boiler using boiler service switch.
2. Disable primary boiler pump. Disconnect multi pin connector J7 from control module. See figure 9-6.
3. Disable secondary system pumps attached to system.
4. Establish call for heat. Jump CHW T-T terminals on low voltage terminal block. Turn on boiler using boiler service switch.
5. Boiler will fire. Based on natural convection within boiler, boiler will either:
 - A. Lockout A-06 "Safety Relay Error". Requires manual reset of control module. Press reset button on User interface. See *9.3 Program Boiler Control* .OR
 - B. Shut off burner E40 "Return Water Temp". This is a soft lockout. When water temperature drops below limit boiler will automatically refire then Lockout A-06 requiring manual reset of control module. Press Reset button on User Interface.OR
 - C. Shut off burner E39 "Flue Temperature Sensor". This is a soft lockout. When flue sensor drops below limit, boiler will automatically refire then Lockout A-06 requiring manual reset of control module. Press Reset button on User Interface.
6. After safety operation is verified, turn off boiler via service switch. Remove jumper in T-T. Replace J7 connector into control module, enable secondary pump operation, turn service switch on and restart system to verify operation.

9 - START UP PROCEDURE

FIGURE 9-6 Control Module J7 Connector

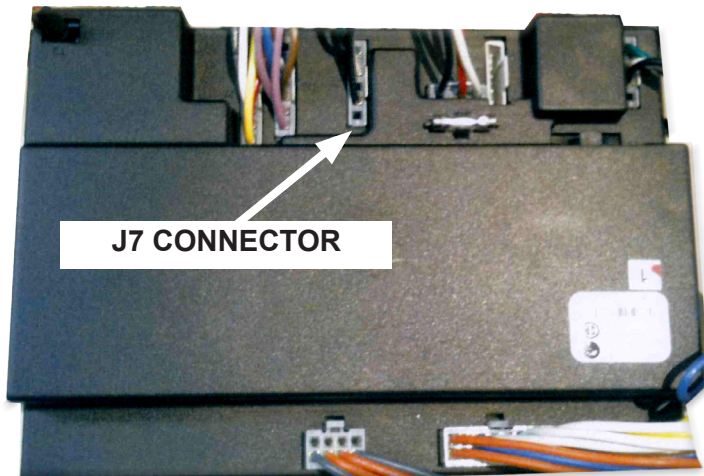

9.7 Complete Start Up Procedure

1. Reset control parameters to operating settings if adjusted to allow startup and operation test.
2. Follow instructions TO TURN OFF GAS TO APPLIANCE (page 39) if boiler is not being placed into immediate operation.
3. Enter installer information on Warranty Registration Card.
4. Gather all instructions, manuals, wiring diagrams, warranty registration card and other supporting information. Review with user and/or affix in conspicuous location adjacent to boiler.

10 - OPERATING INSTRUCTIONS

FOR YOUR SAFETY READ BEFORE OPERATING

⚠ WARNING

If you do not follow these instructions exactly, a fire or explosion may result causing property damage, personal injury or loss of life.

- This appliance is equipped with an ignition device which automatically lights burner. **Do NOT try to light this burner by hand.**
- Before operating smell all around appliance area for gas. Be sure to smell next to floor because some gas is heavier than air and will settle to the floor.
- **Use only your hand to turn the gas shutoff valve.** Never use tools. If valve will not turn by hand, do not try to repair it, call a qualified service technician. Force or attempted repair may result in fire or explosion.
- **Do not use this appliance if any part has been under water.** Immediately call a qualified service technician to inspect appliance and to replace any part of control system and any gas control which has been under water.

10.1 OPERATING INSTRUCTIONS

Stop! Read Safety information above.

- Set thermostat to lowest setting.
- Turn "OFF" all electrical power to appliance.
- This appliance is equipped with an ignition device which automatically lights the burner. **Do not try to light burner by hand!**
- Remove front jacket panel.
- Turn gas shutoff valve clockwise ↻ to closed position. Handle should be perpendicular to gas pipe.
- Wait 5 minutes for any gas to clear. Smell for gas, including near floor. If you smell gas, **STOP!** Follow instructions on this page: "**What To Do If You Smell Gas.**" If you do **not** smell gas, go to next step.
- Turn gas shutoff valve counter clockwise ↺ to the open position. Handle should be parallel to gas pipe.
- Replace front jacket panel.
- Turn "ON" electrical power to appliance.
- Set thermostat to desired setting.
- If the appliance will not operate, follow instructions TO TURN OFF GAS TO APPLIANCE and call your service technician or gas supplier.

⚠ CAUTION

WHAT TO DO IF YOU SMELL GAS

- Do not try to light any appliance.
- Do not touch any electrical switches; do not use any phone in your building.
- Immediately call your gas supplier from a neighbor's phone. Follow the gas supplier's instructions.
- If you cannot reach your gas supplier, call the fire department.

10.2 TO TURN OFF GAS TO APPLIANCE

- Set thermostat to lowest setting.
- Turn "OFF" all electric power to appliance if service is to be performed.
- Remove front jacket panel.
- Turn gas shutoff valve handle clockwise ↻ to closed position. Handle should be perpendicular to gas pipe.
- Replace front jacket panel.

10-1 Gas Shutoff Valve

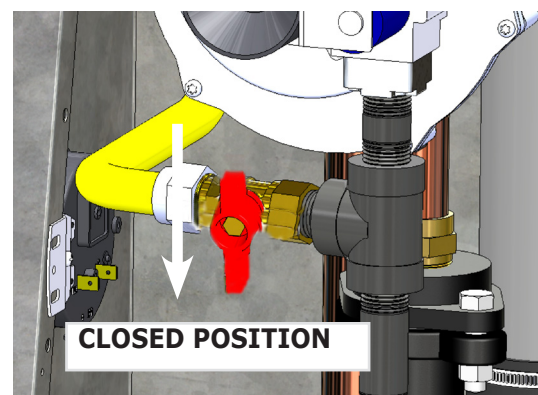
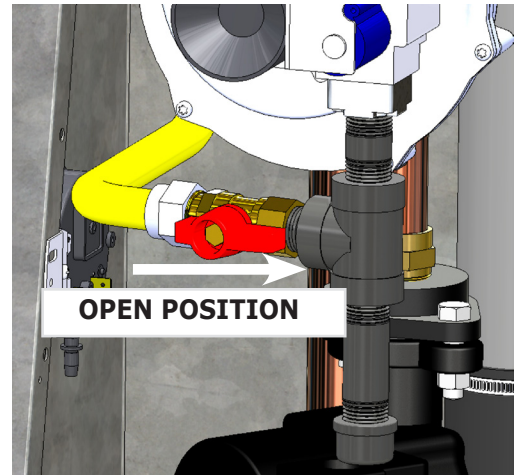

11 - GENERAL MAINTENANCE AND CLEANING

⚠ DANGER

Before servicing, turn off electrical power to boiler at service switch. Close manual gas valve to turn gas supply OFF to boiler.

⚠ CAUTION

Label all wires prior to disconnection when servicing controls. Wiring errors can cause improper and dangerous operation.

NOTICE

Verify proper operation after servicing.

NOTICE

Perform regular service and maintenance by qualified service agency at least once every 12 months to assure safe, trouble free operation and maximum efficiency.

11-1 Sight Glass



11.1 Beginning of Each Heating Season

- Check boiler area is free from combustible materials, gasoline, and other flammable vapors and liquids.
- Visually inspect combustion air and vent piping for proper operation. Check for and remove any obstruction to flow of combustion air or vent gases. Immediately repair or replace pipe showing deterioration or leakage. Reassemble per instructions in section 6. Ensure proper reassembly and resealing of system.
- Visually inspect condensate drain line for proper operation. Checking for deteriorated or plugged condensate drain line. Verify condensate trap drains freely.
- Test safety relief valve for proper operation. Refer to valve manufacturer's instructions packaged with relief valve.
- Examine flue passages in heat exchanger, burner, condensate lines, and cleaning (if necessary) by following instructions in "Annual Examination and Cleaning of Boiler Components" in this section.
- Circulator pump and combustion air blower motor furnished with boiler are permanently lubricated from factory and require no further lubrication. Lubricate field sourced pumps and/or motors should be lubricated according to pump and/or motor manufacturer's instruction.
- Check following components are operating properly and are free of blockages or obstructions:
 - air vent;
 - check venturi air inlet for blockage and clean as required;
 - check air hose is tight
 - supply, return, and flue temperature sensor clips must be securely seated on pipes; Check boiler for any sign of leaks.
- Check low water cutoff using user interface.
 - Check operation by pressing test button on low water cutoff.
 - "Low Water" LED should illuminate and burner should shut down.
 - Should get error message on User Interface (E36).
 - Every 5 years remove low water cutoff. Reinstall after cleaning.
 - Every 10 years replace low water cutoff.
- Check flame signal with user interface. Should be 8 micro amps at 100%.
- Visual inspection of flame through sight glass. Burner should be fully illuminated. See figure 11-1.
- Check expansion tank.

11 - GENERAL MAINTENANCE AND CLEANING

11.2 Annual Shut Down Procedure

- Follow instructions "To Turn Off Gas To Appliance" unless boiler is also used to supply domestic hot water. See section 10 page 39.
- Drain system completely and add antifreeze when heating system is to remain out of service during freezing weather.
- Drain condensate lines when boiler is to be exposed to freezing temperatures.

⚠ WARNING

Following service procedures must be performed by qualified service agent. Boiler owner shall not attempt these steps. Failure to do so could result in death or serious injury.

11.3 Annual Examination and Cleaning of Boiler Components

- Obtain Burner Inspection Kit. Follow kit instructions to prepare for examination and cleaning.
- Burner and heat exchanger inspection and cleaning.
 - Remove gasket and burner. Allow burner to clear top lip of chassis.
 - Remove any residual sleeve and/or gasket material from removed burner.
 - Clean burner using air hose directed into top of burner opening to dislodge any debris in burner ports. Inspect burner for foreign matter in flame ports or inside burner. Remove foreign matter by blowing with compressed air or vacuuming. Replace burner if it cannot be cleaned or is showing deterioration.
 - Clean heat exchanger with low pressure water spray. Use flexible handle nylon brush to loosen sediment and oxide on all accessible heating surfaces of heat exchanger. Take care not to get brush stuck in heat exchanger.
 - Remove any remaining loosened sediment using shop vacuum with snorkel attachment.
 - Clean condensate collector if significant debris found in heat exchanger.
 - Expand upper spring tension clip of condensate trap using hose clamp pliers. Disconnect condensate trap from condensate collector. See figure 9-1 page 33.
 - Disconnect wire harness from vent temperature sensor. See (15) figure 3-2 page 9.

11-2 Blower Inlet Assembly

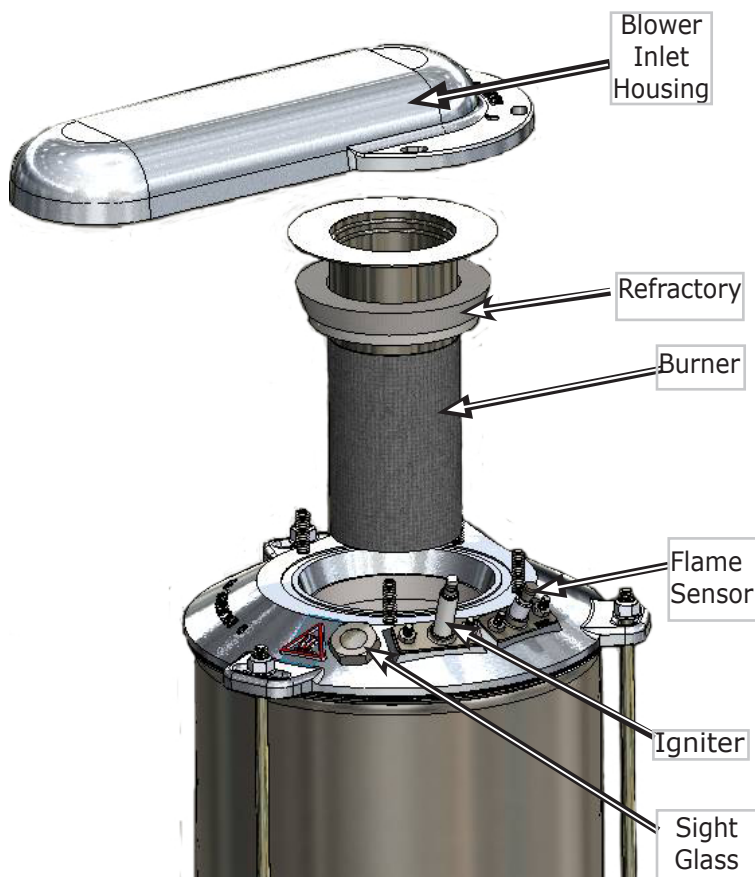

11 - GENERAL MAINTENANCE AND CLEANING

11-3 Condensate Collector

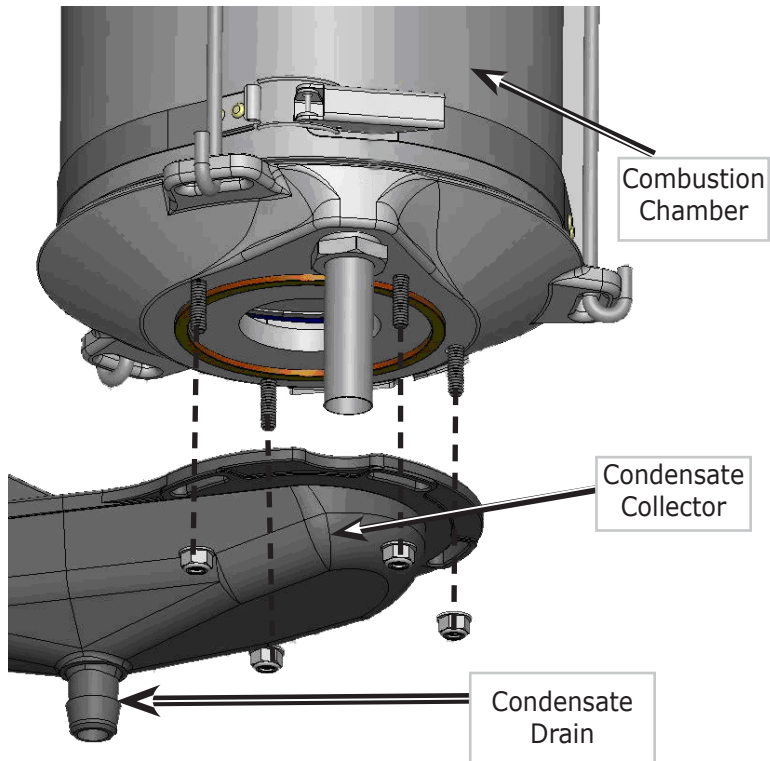

- Loosen upper hose clamp securing condensate collector to flue pipe using 3/8" socket with 6" extension.
- Remove 1/4-20 hex flange nuts securing condensate collector to heat exchanger using 7/16" deep well socket. See figure 11-3.
- Remove condensate collector assembly from heat exchanger and flue pipe.
- Flush collector and condensate trap with water.
- Follow Burner Inspection Kit instructions to reassemble boiler and resume operation.

12 - RATINGS AND CAPACITIES

 SEA LEVEL RATINGS NATURAL AND PROPANE GASES					
Size	Boiler Input Rate (MBH)⁽¹⁾		Heating Capacity (MBH)⁽¹⁾⁽²⁾	Net AHRI Rating, Water (MBH)⁽¹⁾⁽³⁾	AFUE⁽²⁾
	Maximum	Minimum			
075	75	15	69	60	97
100	100	20	91	79	97

⁽¹⁾ 1000 Btu/hr (British Thermal Units Per Hour)
⁽²⁾ Heating Capacity and AFUE (Annual Fuel Utilization Efficiency) are based on DOE (Department of Energy) test procedures.
⁽³⁾ Net AHRI Ratings based on piping and pickup allowance of 1.15. Contact Technical Support before selecting boiler for installations having unusual piping and pickup requirements, such as intermittent system operation, extensive piping systems, etc.

12.1 Ratings and Capacities

- Constructed and hydrostatically tested for maximum allowable working pressure of 50 psig (pounds per square inch gauge) (345 kPa) in accordance with ASME Boiler and Pressure Vessel Code, Section IV, Rules for Construction of Heating Boilers.
- Ratings used for elevations up to 2000 ft (600m) above sea level.
- For elevations between 2000 ft (600m) and 4500 ft (1350m), install high altitude control kit
- For elevations above 4500 ft (1350m) install high altitude control kit and :
 - USA - Reduce input rate 4% for each 1000 ft (300m) beyond 4500 ft.
 - Canada - Boiler derates input 10% for every 2000 feet (610 m) above an elevation of 4500 feet (1.37 km).

13 - TROUBLE SHOOTING

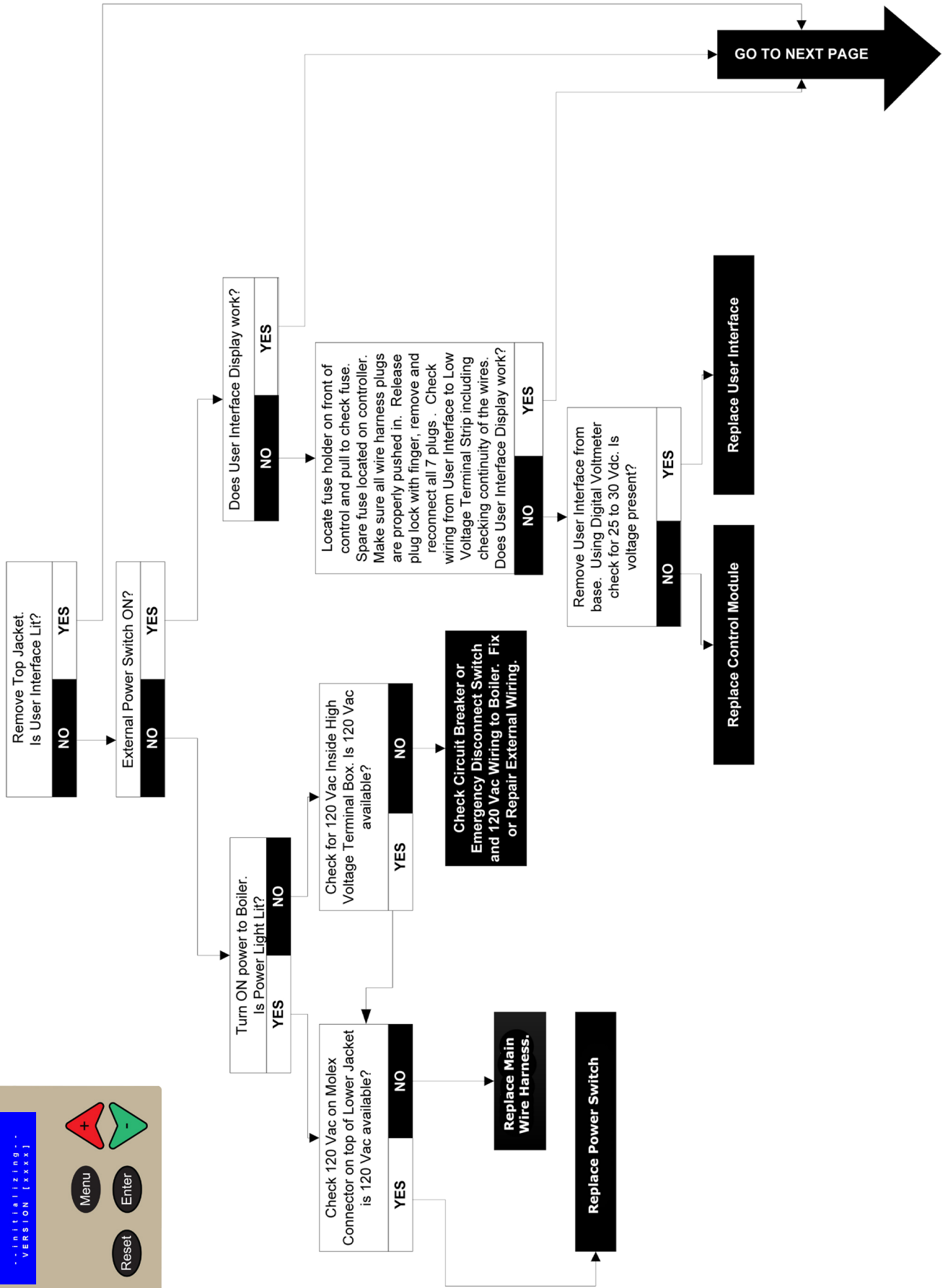
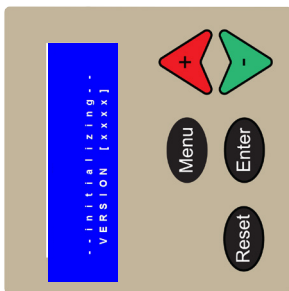

Screen Display	Explanation	Go to Page For Troubleshooting
----- Lockout Alarm A 0 0 Blocking Too Long Error	Control has blocking error for more than 20 hours in a row.	Go to Page 47
----- Lockout Alarm A 0 1 Ignit Error	Three unsuccessful ignition attempts in a row	Go to Page 48
----- Lockout Alarm A 0 5 GV Relay Error	Open gas valve power circuit. May involve high temperature switch, gas valve, or gas valve relay in control module.	Go to Page 47
----- Lockout Alarm A 0 6 Safety Relay Error	Safety Circuit is open.	Go to Page 49
- P ----- Lockout Alarm A 0 8 Fan Error	Blower speed does not reach speed calculated by Control Module.	Go to Page 50
----- Lockout Alarm A 0 9 to A 1 4 Various Text Messages	Control Module internal error.	Replace Control Module
----- Lockout Alarm A 1 8 Max Temp Error	High Temperature opens during normal operation.	Go to Page 51
----- Lockout Alarm A 2 0 Flame Out Too Late	Control Module detects flame after gas valve is closed more than 10 seconds.	Replace Gas Valve
----- Lockout Alarm A 2 1 Flame Error 1	Flame is detected before gas valve opens.	Replace Gas Valve
----- Lockout Alarm A 2 2 A 2 3 Various Text Messages	Control module internal error.	Replace Control Module
----- Lockout Alarm A 2 4 3 Flame Failures	Lost flame signal 3 times during one heat call.	Go to Page 52
----- Lockout Alarm A 2 7 to A 3 0 Various Text Messages	Control Module internal error.	Replace Control Module
----- Blocking Error E 3 1 to E 3 4 Various Text Messages	Control Module internal error.	Replace Control Module
----- Blocking Error E 3 3 REFLO too LO	External voltage supplied to DHW T-T or CH T-T terminals. Eliminate voltage using dry contact relay.	-
F P ----- Blocking Error E 3 5 False Flame Detect	Flame detected when gas valve is closed.	Go to Page 52

13 - TROUBLE SHOOTING

Screen Display	Explanation	Go to Page For Troubleshooting
----- Blocking Error E 3 6 Low Water Cutoff	Low water cutoff sees no water.	Go to Page 53
----- Blocking Error E 39 Flue Gas Error	Flue temperature sensor sees temperature higher than 200°F.	Go to Page 54
----- Blocking Error E 4 0 Return Temp	Return water temperature sensor sees temperature higher than 200°F.	Go to Page 55
----- Blocking Error E 4 3 Various Text Messages	Control board internal error. Power down then power up boiler. If error repeatedly occurs replace control module.	Replace Control Module
----- Blocking Error E 4 4 Phase Error	Boiler is powered by three wires, hot, neutral and ground. E44 displays when neutral wire is not neutral.	Go to Page 55
----- Blocking Error E 4 5 Net Freq Error	Control board sees power supply frequency not in range of 59 to 61 Hz.	Go to Page 56
----- Blocking Error E 4 6 Faulty Earth Error	Boiler power supply ground wire is not grounded.	Go to Page 57
----- Blocking Error E 4 7 Various Text Messages	Control board internal error. Power down then power up boiler. If error repeatedly occurs replace control module.	Replace Control Module
- P ----- Blocking Error E 5 1 Supply Sens Open	Supply temperature sensor is open. No continuity.	Go to Page 56
- P ----- Blocking Error E 5 2 Return Sens Open	Return water temperature sensor is open. No continuity.	Go to Page 57
- P ----- Blocking Error E 5 7 Flue Sens Shorted	Flue temperature sensor is open. No continuity.	Go to Page 59
- P ----- Blocking Error E 5 9 Supply Sens Shorted	Supply water temperature sensor is shorted. '0' Ohm	Go to Page 59
- P ----- Blocking Error E 6 0 Return Sens Shorted	Return water temperature sensor is shorted. '0' Ohm	Go to Page 60
- P ----- Blocking Error E 6 5 Flue Sens Open	Flue temperature sensor is shorted. '0' Ohm	Go to Page 60
- P ----- Blocking Error E 6 6 Reset Button Error	Reset button was pressed too many times.	Error Clears in 1-2 minutes
----- Blocking Error E73 to E79 Various Fan Error Te) E 81, 88, 89	Fault detected in blower motor system.	Go to page 56

P ---
Lockout Alarm A 0 5
GV relay error

Lockout Alarm A 0 0
Blocking too long error

Enter Installer Menu, Boiler Status. Scroll to most recent Lockout Alarm or Blocking Error. Diagnose corrective action using appropriate Troubleshooting Tree.

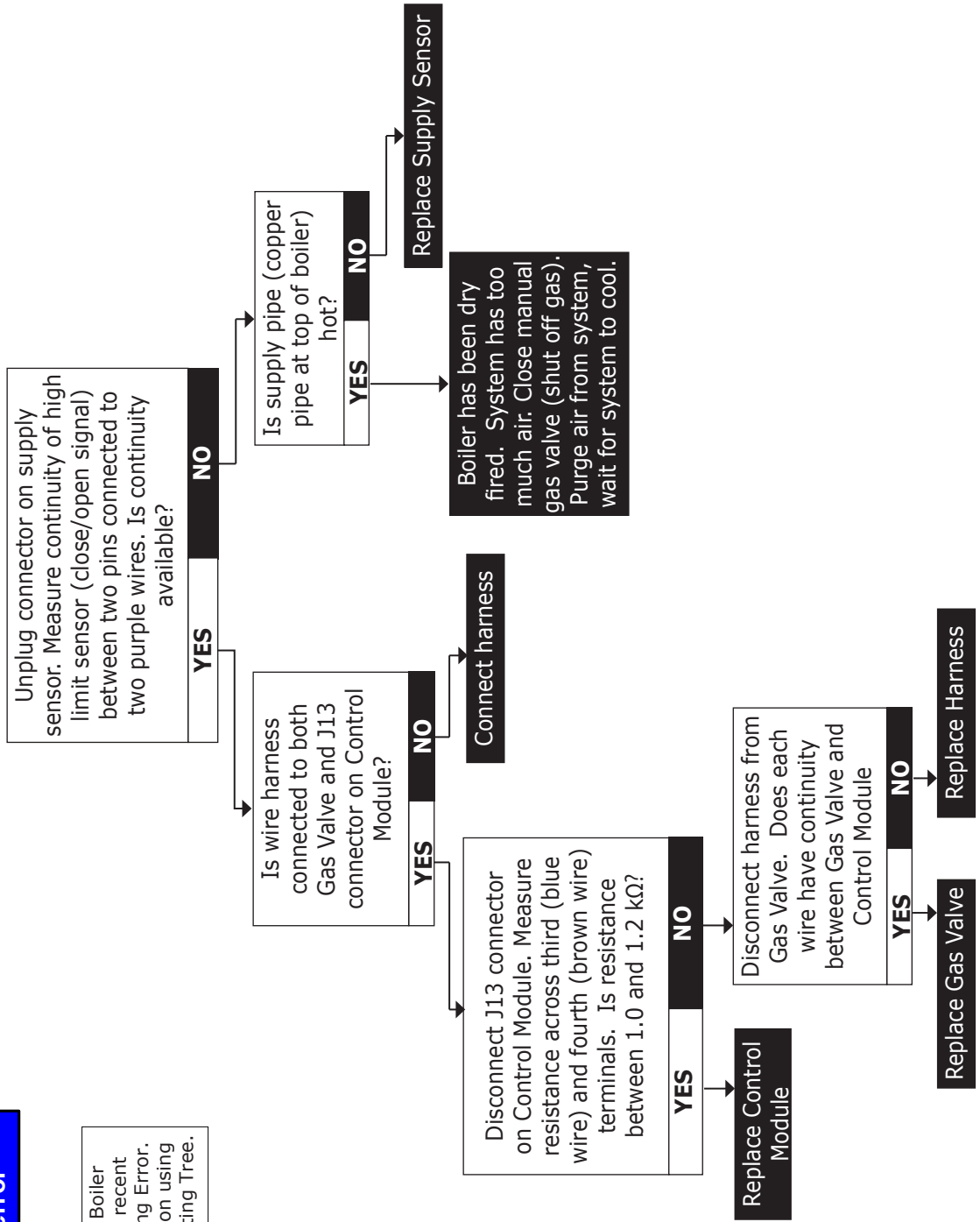

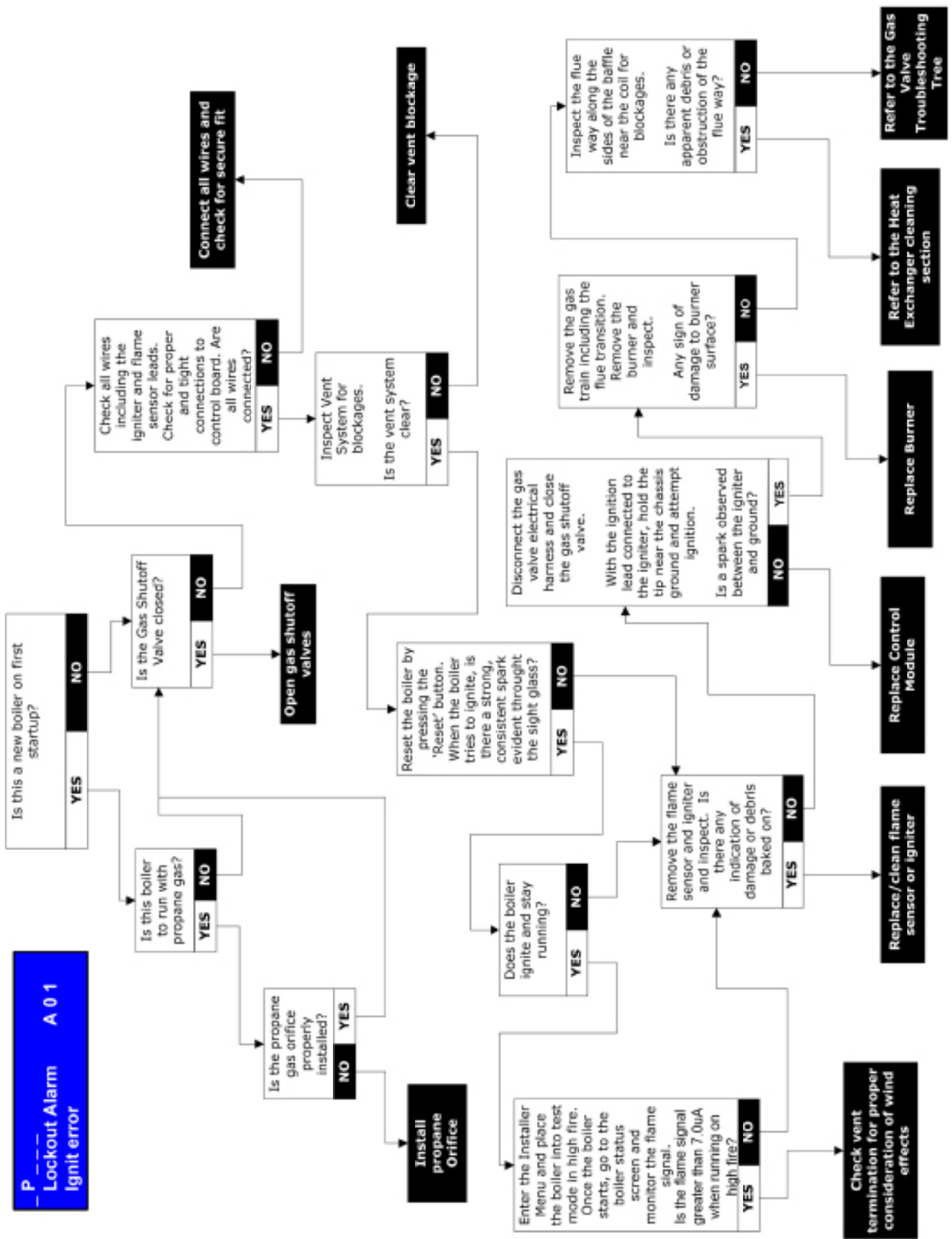

Lockout Alarm **A 0 6**
Safety Relay Error

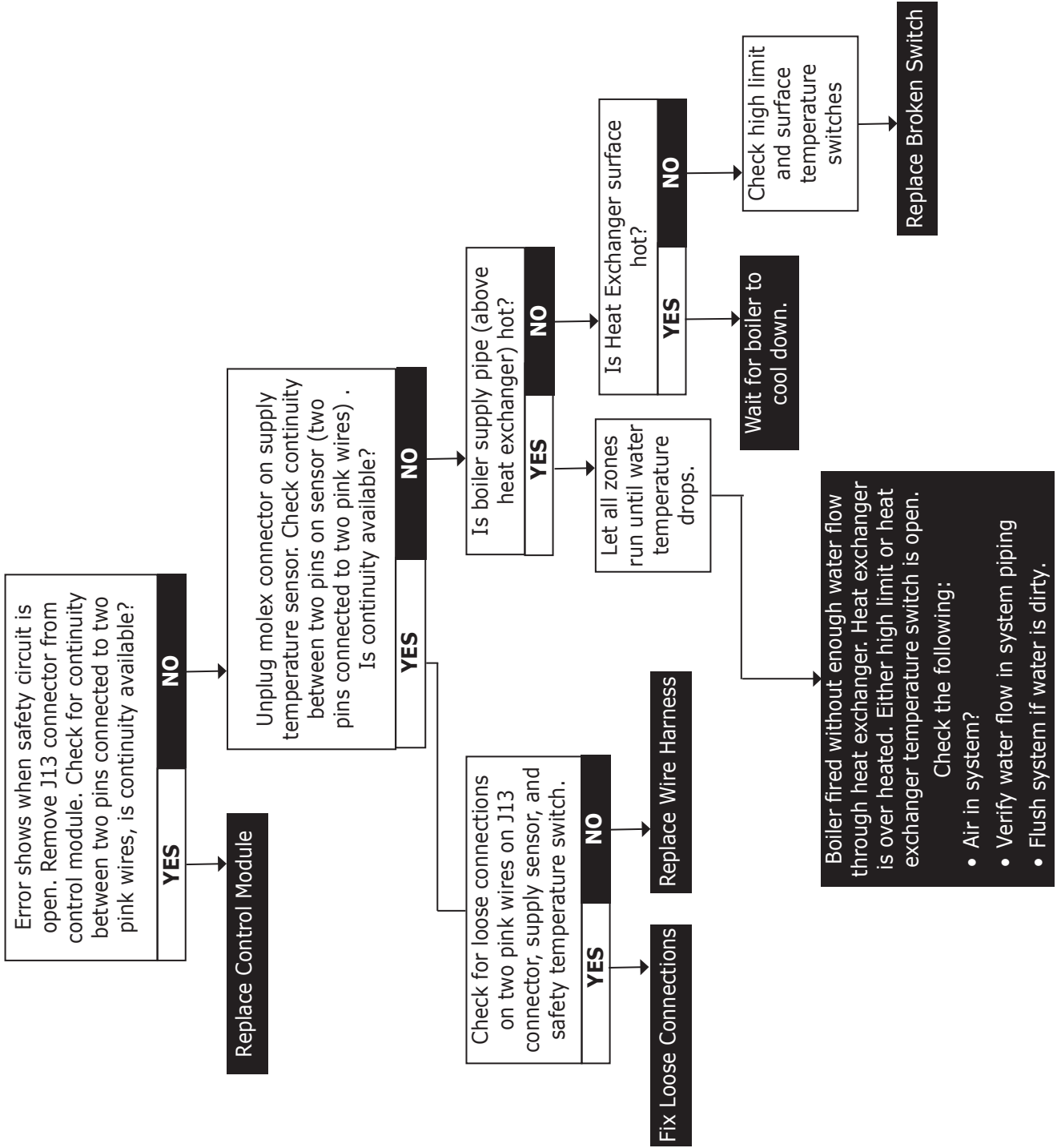

**Lockout Alarm A 0 8
Fan error**

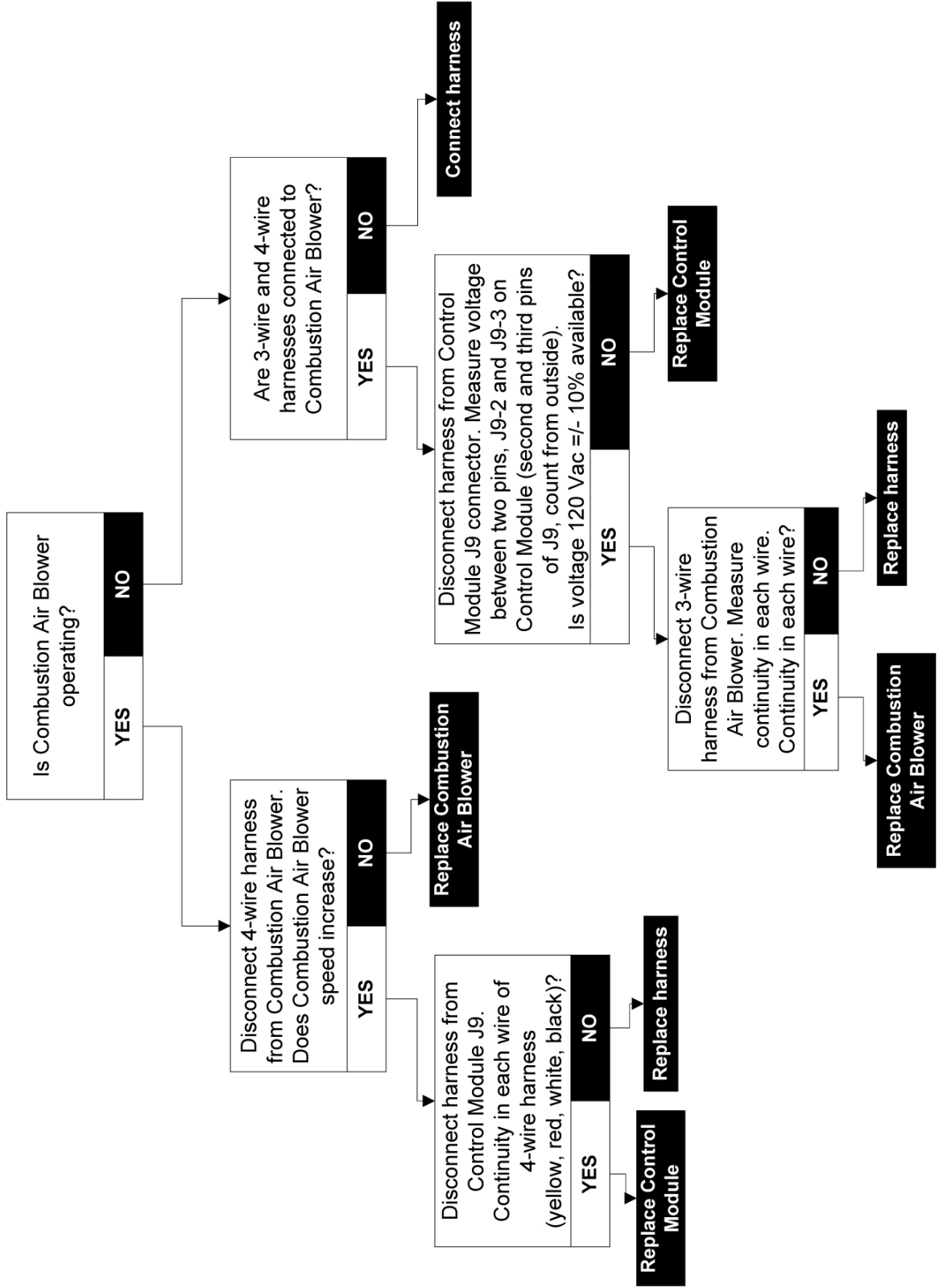

**Lockout Alarm A 18
Max Temp Error**

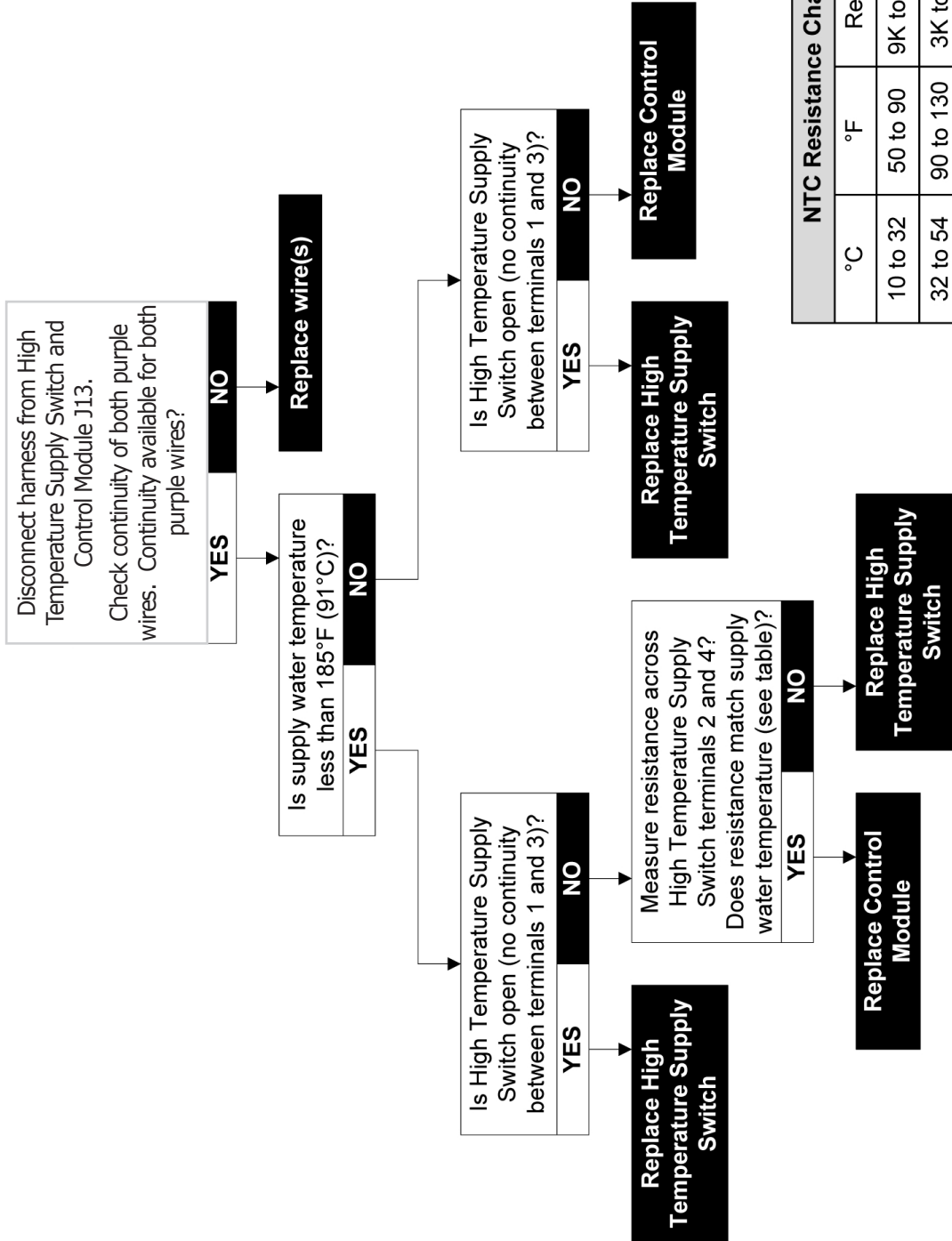

NTC Resistance Chart		
°C	°F	Resistance
10 to 32	50 to 90	9K to 24K ohms
32 to 54	90 to 130	3K to 9K ohms
54 to 66	130 to 150	2K to 3K ohms
66 to 94	150 to 200	2K to 1K ohms

P Lockout Alarm A 2 4
3 flame failures

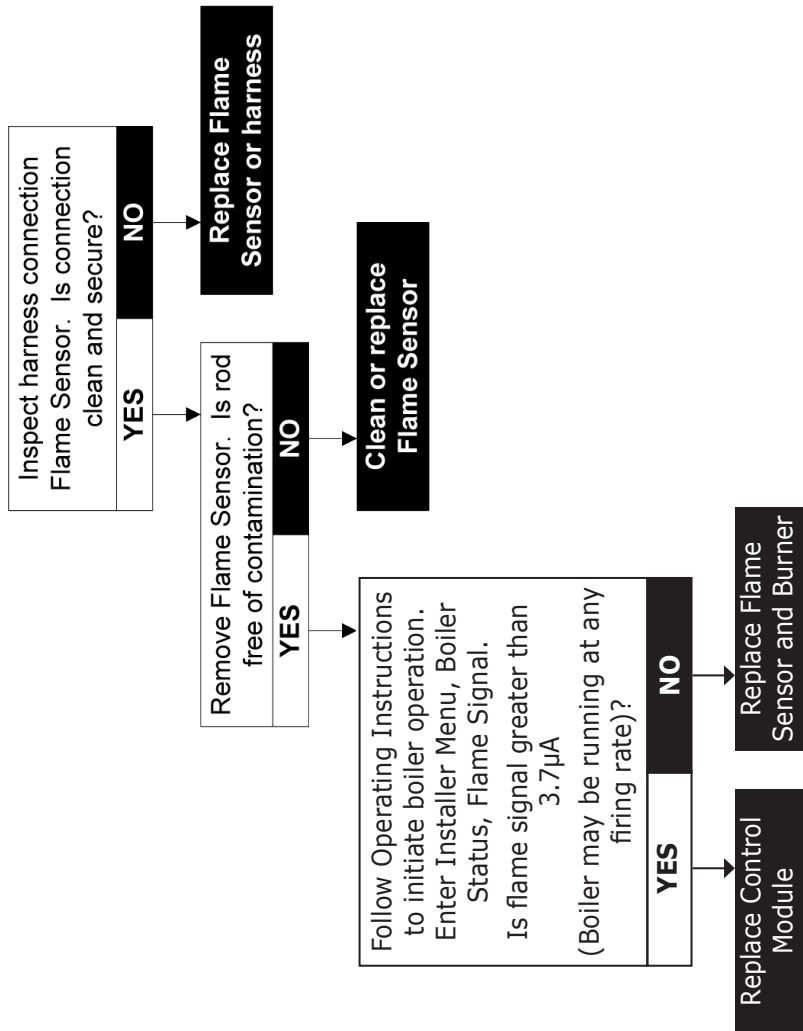

P Blocking Error E 3 5
False flame detect

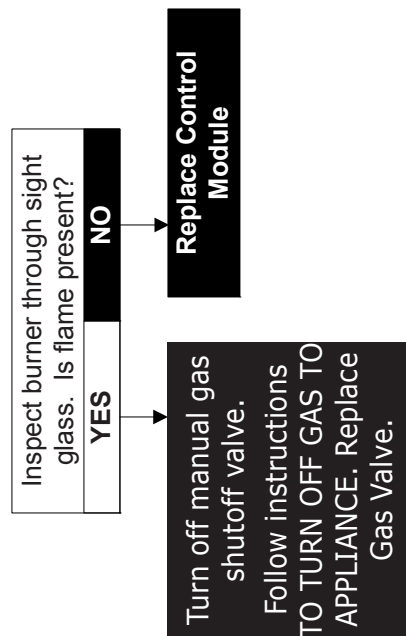

Blocking Error E 3 6
Low Water Cutoff

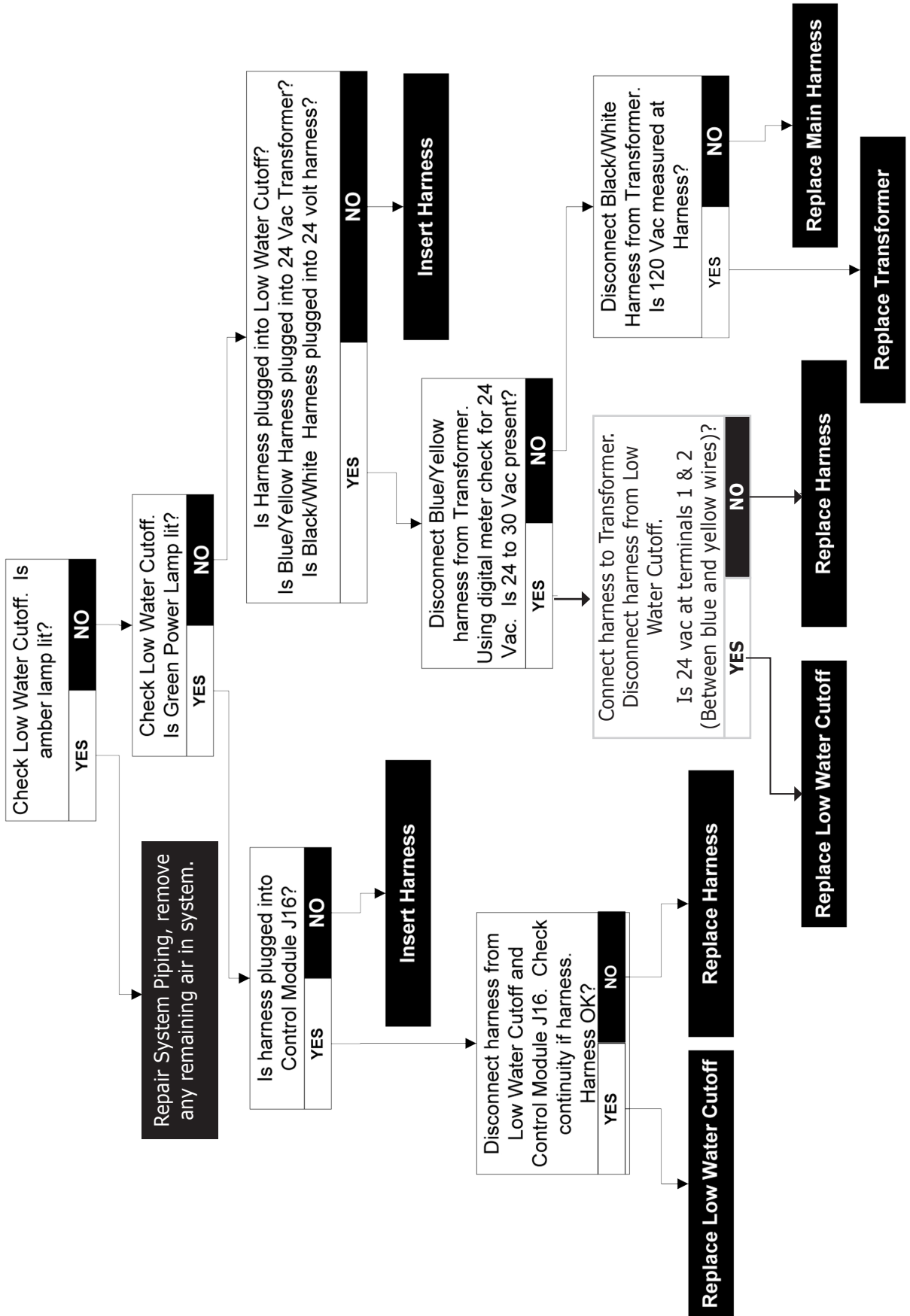

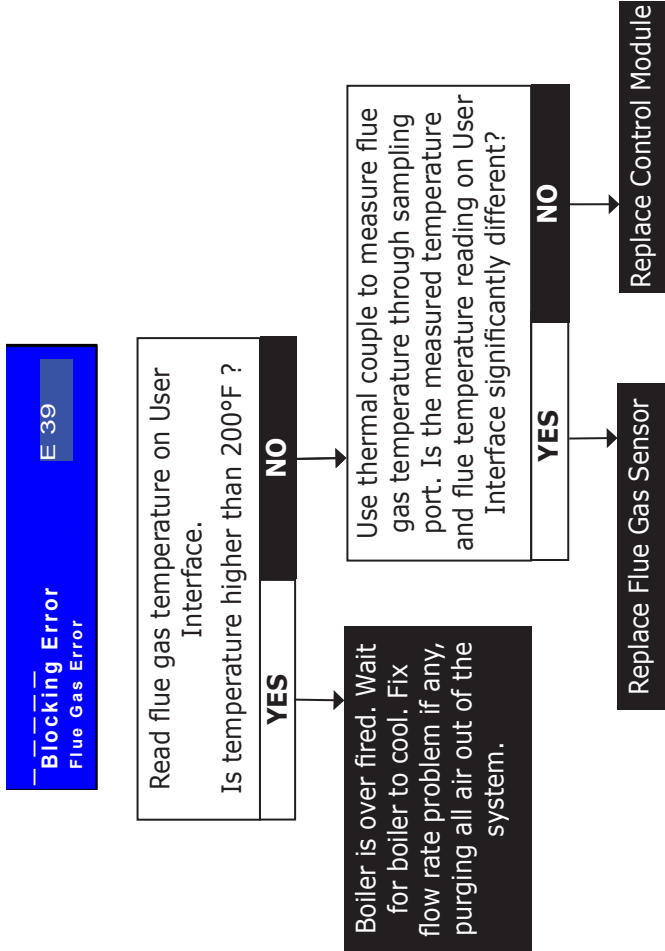

Blocking Error E 4 0
Return Temp

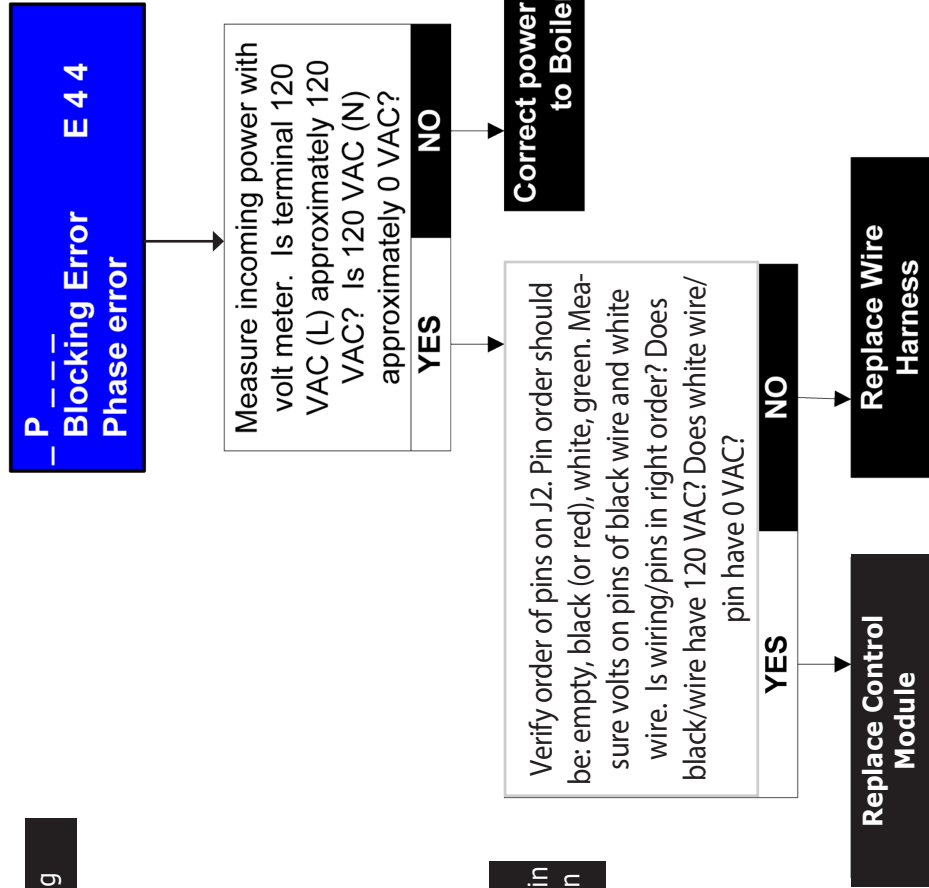
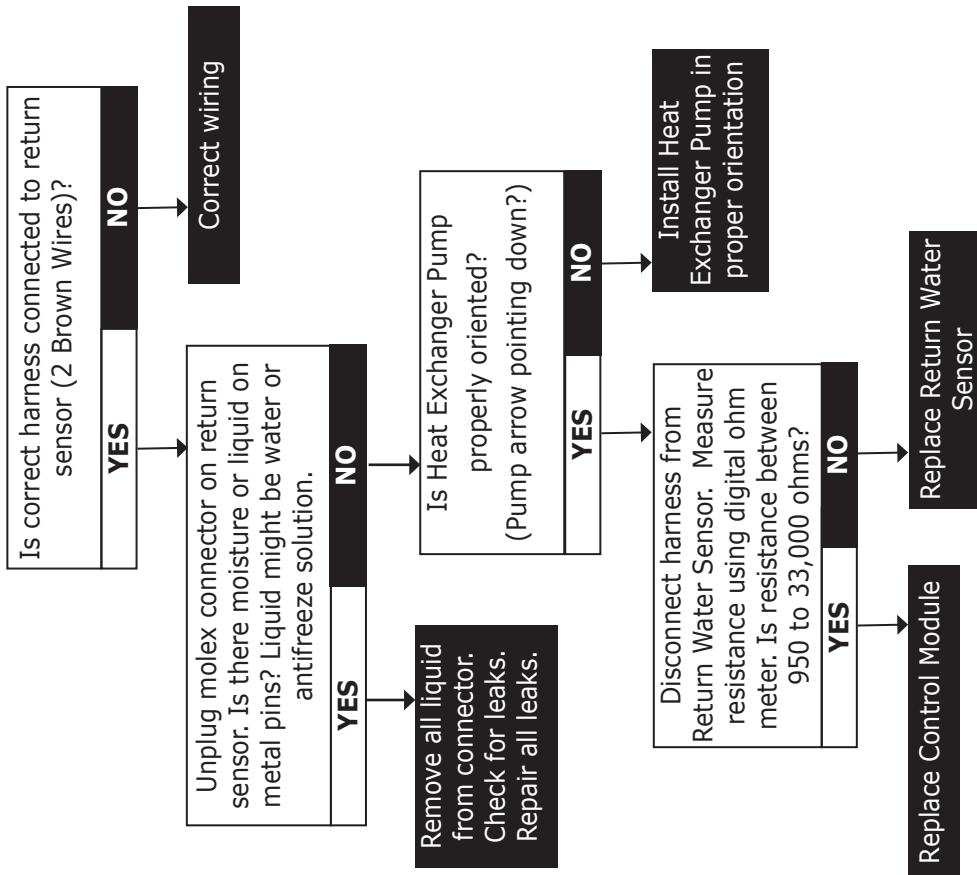

**-----
Blocking Error
Various Fan Error Te) E 81, 88, 89**

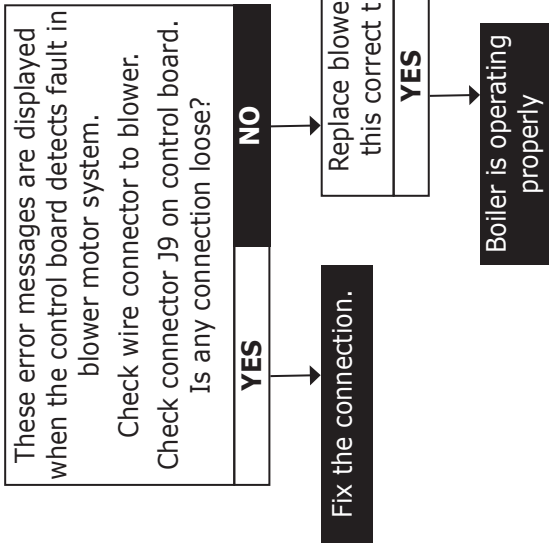

**-----
Blocking Error E 4 5
Net frequency error**

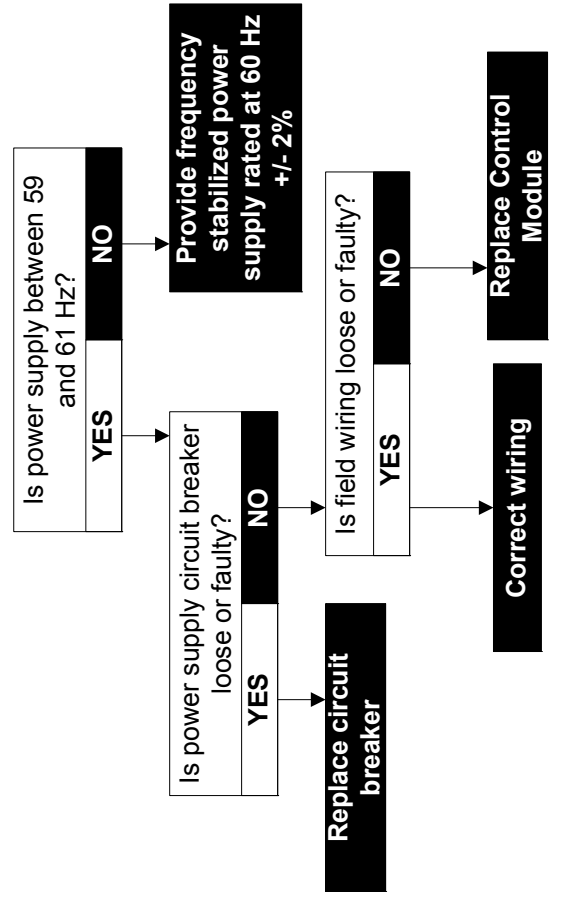

P **Blocking Error E 4 6**
Faulty ground

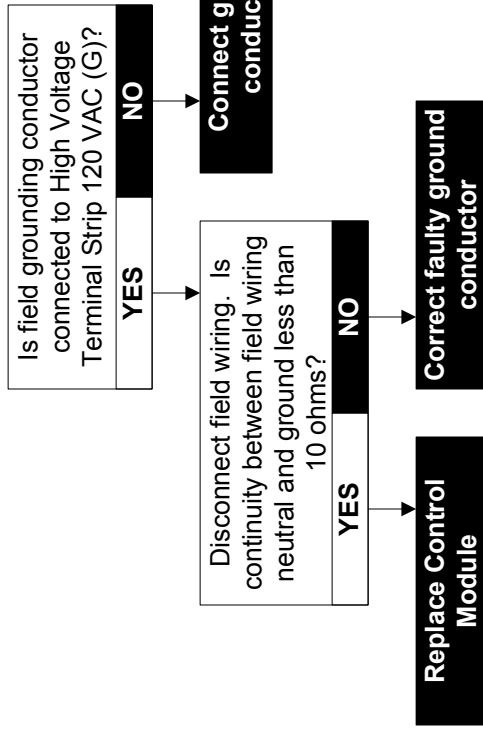

P **Blocking Error E 5 1**
Supply Sens Open

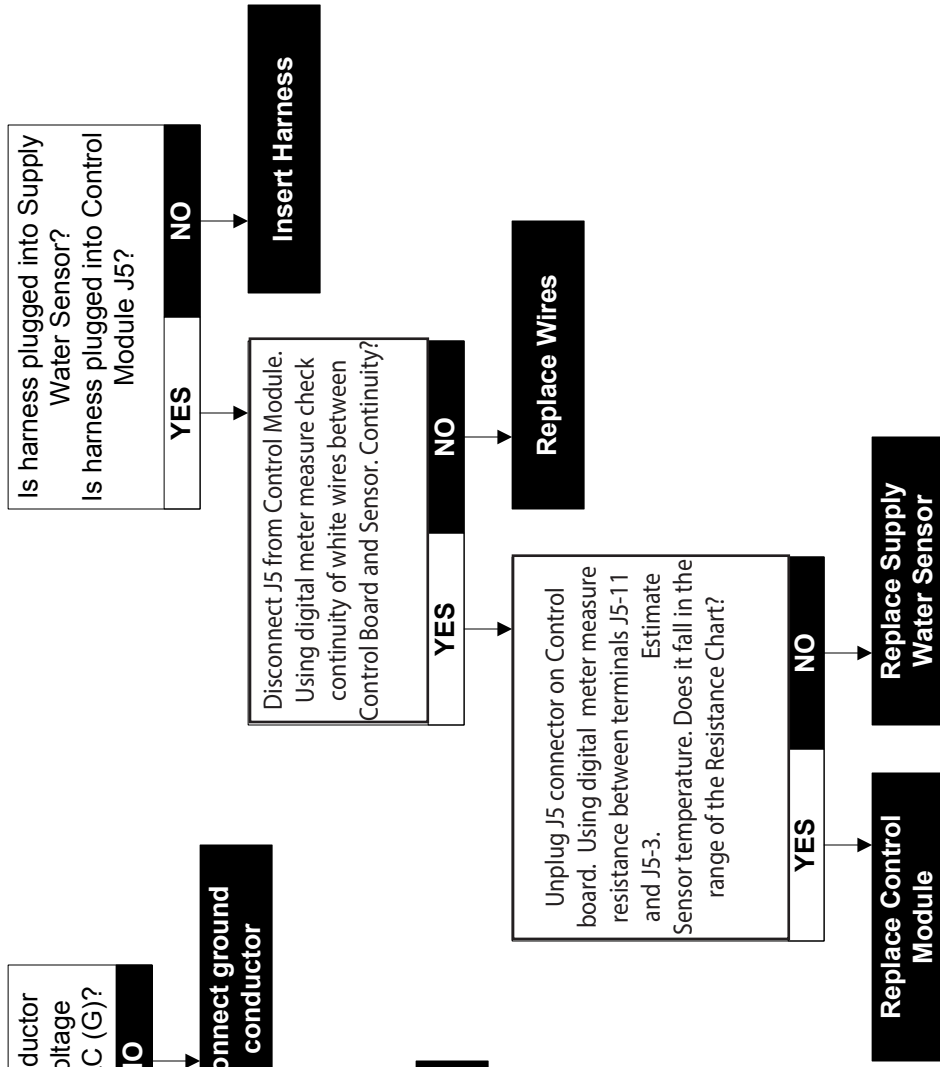

Supply Water Sensor Resistance Chart		
°C	°F	Resistance
10 to 32	50 to 90	9K to 24K ohms
32 to 54	90 to 130	3K to 9K ohms
54 to 66	130 to 150	2K to 3K ohms
66 to 94	150 to 200	2K to 1K ohms

P - - - - -
Blocking Error E 5 2
Return Sens Open

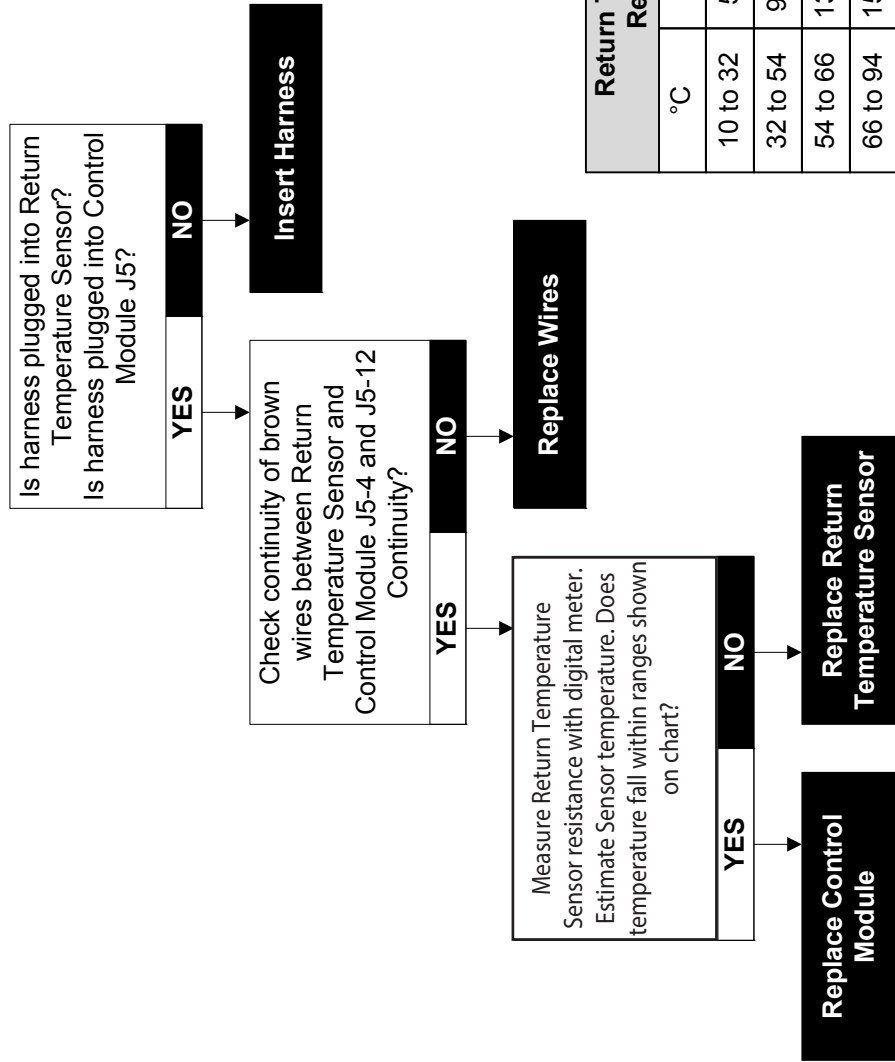

Return Temperature Sensor Resistance Chart		
°C	°F	Resistance
10 to 32	50 to 90	9K to 24K ohms
32 to 54	90 to 130	3K to 9K ohms
54 to 66	130 to 150	2K to 3K ohms
66 to 94	150 to 200	2K to 1K ohms

P **Blocking Error E 5 7**
Flue sens open

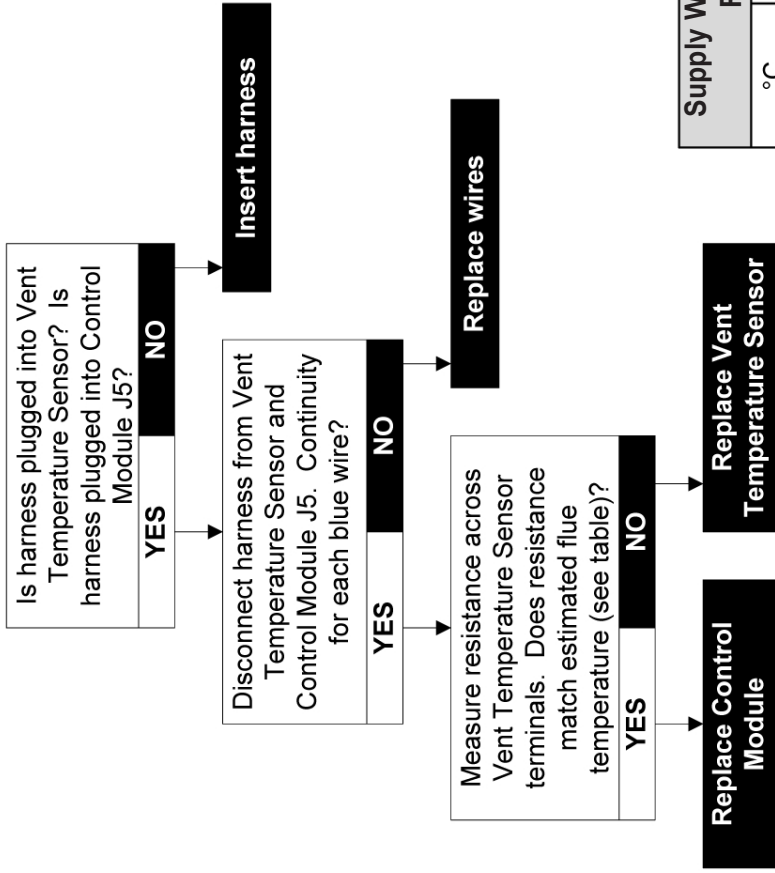

P **Blocking Error E 5 9**
Supply Sensor Shorted

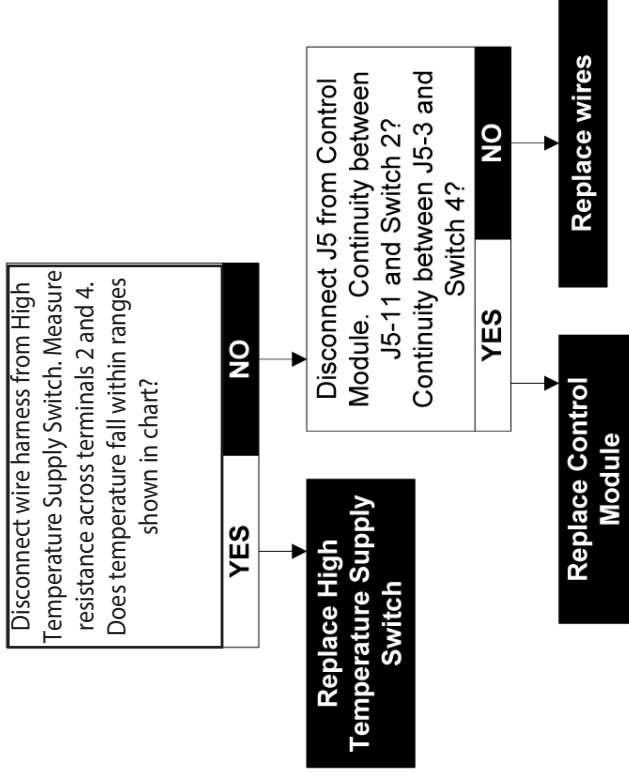

Supply Water Temperature Sensor Resistance Chart

°C	°F	Resistance
10 to 32	50 to 90	9K to 24K ohms
32 to 54	90 to 130	3K to 9K ohms
54 to 66	130 to 150	2K to 3K ohms
66 to 94	150 to 200	2K to 1K ohms

P **Blocking Error E 6 5**
Flue Sens Shorted

Disconnect wire harness from Vent Temperature Sensor. Measure Sensor resistance. Does resistance match estimated flue temperature?

YES	NO
------------	-----------

Replace Vent Temperature Sensor

Disconnect harness from Control Module J5. Continuity in blue wires?

YES	NO
------------	-----------

Replace wires

Replace Control Module

P **Blocking Error E 6 0**
Return sens shorted

Disconnect harness from Return Temperature Sensor. Measure resistance across sensor terminals. Is resistance less than 50 ohms?

YES	NO
------------	-----------

Replace Return Water Sensor

Disconnect harness from Control Module J5. Measure resistance between brown wires at terminals J5-4 and J5-12. Is resistance less than 50 ohms?

YES	NO
------------	-----------

Replace wires

Replace Control Module

Vent Temperature Sensor Resistance Chart		
°C	°F	Resistance
10 to 32	50 to 90	9K to 24K ohms
32 to 54	90 to 130	3K to 9K ohms
54 to 66	130 to 150	2K to 3K ohms
66 to 94	150 to 200	2K to 1K ohms

14 - WIRING DIAGRAM

14.2 Schematic Diagram of Ladder Form

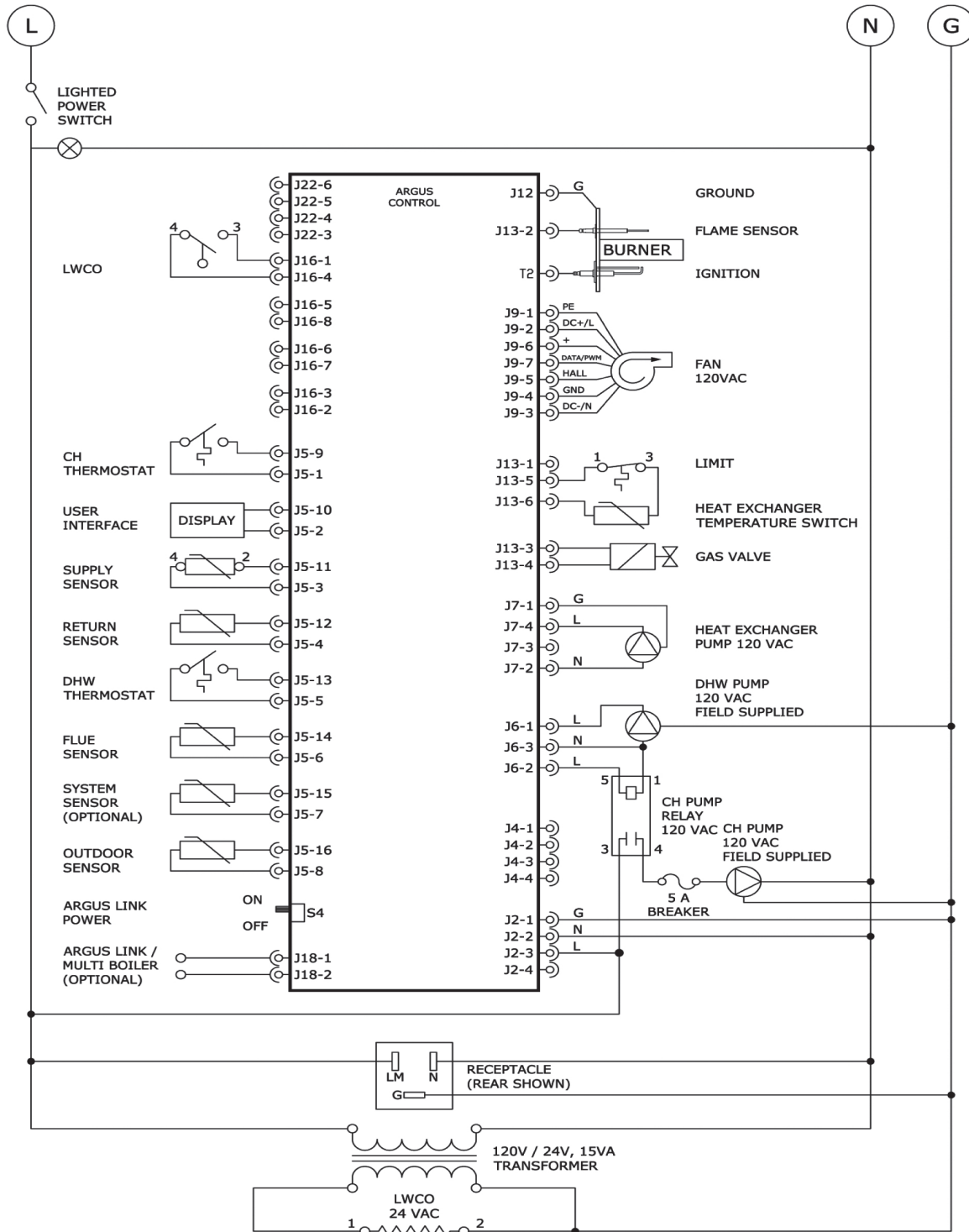

240008270 REV F 04/2012

15 - GLOSSARY

- **ANSI** - American National Standards Institute, Inc. oversees creation and maintenance of voluntary consensus standards, including ANSI Z21.13/CSA 4.9: Gas-Fired Low Pressure Steam and Hot Water Boilers.
- **ASTM** - American Society for Testing and Materials. ASTM International is one of largest voluntary standards development organizations in world trusted source for technical standards for materials, products, systems, and services. Known for their high technical quality and market relevancy, ASTM International standards have important role in information infrastructure that guides design, manufacturing and trade in the global economy.
- **AUTHORITY HAVING JURISDICTION** - Individual or organization adopting and enforcing codes, rules, and by-laws governing various concerns of community. Commonly referred to as "final authority" for any matters relating to LIFE SAFETY and BUILDING CONSTRUCTION within a community.
- **Btu** - Abbreviation for British Thermal Unit. Quantity of heat required to raise temperature of 1 pound of water 1°F.
- **BURNER** - Device for final conveyance of gas or mixture of gas and air, to combustion zone.
- **COMBUSTION** - Rapid oxidation of fuel gases accompanied by production of heat or heat and light. Complete combustion of fuel is possible only in presence of adequate supply of oxygen.
- **COMBUSTIBLE MATERIAL** - Materials made of or surfaced with wood, compressed paper, plant fibers, or other materials capable of being ignited and burned. Such material shall be considered combustible even though flame-proofed, fire-retardant treated, or plastered.
- **CONDENSATE** - Liquid separated from flue gas due to reduction in temperature.
- **DIRECT VENT BOILER** - Boiler constructed and installed so all combustion air is derived directly from outdoors and all vent gases are discharged to outdoors.
- **DRAFT** - Pressure difference causes gases or air to flow through a chimney, vent, flue or appliance.
- **FLA** - Full load amps.
- **FLUE GASES** - Products of combustion plus excess air in appliance flues or heat exchanger.

● **GAS PIPE SIZES - Table 14**

NATURAL GAS				
Length of Pipe - Ft.	Pipe Capacity - BTU Per Hour Input Includes Fittings			
	1/2"	3/4"	1"	1 1/4"
20	92,000	190,000	350,000	625,000
40	63,000	130,000	245,000	445,000
60	50,000	105,000	195,000	365,000
PROPANE GAS				
Length of Pipe - Ft.	Pipe Capacity - BTU Per Hour Input Includes Fittings			
	Copper Tubing (Outside Diameter)		Iron Pipe	
	5/8"	3/4"	1/2"	3/4"
20	131,000	216,000	189,000	393,000
40	90,000	145,000	129,000	267,000
60	72,000	121,000	103,000	217,000

- **HIGH-VOLTAGE** - Circuit involving potential of not more than 600 volts and having circuit characteristics in excess of those of low-voltage circuit.
- **IGNITER** - Device utilizing electrical energy to ignite gas at main burner.
- **LEAK CHECK** - Operation performed on gas piping system to verify system does not leak.
- **LOW WATER CUTOFF** - Device constructed to automatically cut off fuel supply when surface of water in boiler falls to lowest safe water level.
- **LOW-VOLTAGE** - Circuit involving potential of not more than 30 volts.
- **METRIC GAS METERS**

$$\text{MBH} = \frac{127,116 \times \text{cu meters}}{\text{Seconds}}$$

For example: Gas Meter measures 0.1 cubic Meters in 100 seconds

$$\text{MBH} = \frac{127,116 \times 0.1}{100} = 127 \text{ MBH}$$
- **PRESSURE TEST** - Operation performed to verify gas tight integrity of gas piping following its installation or modification.
- **PURGE** - To free gas conduit of air or gas, or mixture of gas and air.
- **PURGE TIME** - Period of time intended to allow for dissipation of any unburned gas or residual products of combustion.

15 - GLOSSARY

- **QUALIFIED AGENCY** - Any individual, firm, corporation, or company engaged in and responsible for:
 - Installation, testing, or replacement of gas piping, or connection, installation, testing, repair or servicing of appliances and equipment.
 - Experienced in such work.
 - Familiar with all precautions required.
 - Complies with all requirements of authority having jurisdiction.
- **SAFETY RELIEF VALVE** - Valve designed to relieve pressure in hot water supply system when pressure exceeds pressure capability of equipment.
- **SAFETY SHUTOFF DEVICE** - Device that will shut off gas supply to controlled burner in event source of ignition fails.
- **SEDIMENT TRAP** - Gas piping arrangement designed to collect any liquid or solid contaminant before reaching gas valve.
- **VENT** - Passageway used to convey flue gases from appliance vent connector to outdoors.
- **VENTING SYSTEM** - Continuous open passageway from of appliance vent connector to outdoors for purpose of removing flue or vent gases.

APPENDIX A - CONTROL MODULE





1.1 Introduction

The boiler is equipped with a programmable electronic control and user interface module.

Operation with LCD character display module

1.2 Operation

- Display: 4x20 character LCD screen to show boiler status.
- Function Keys

Key	Description
	- Manual Lockout Reset
	- Enter/Exit user menu - Go to previous screen
	- Select a menu item - Confirm new parameter value
	- Scroll up to next menu item - Increase value
	- Scroll down to next menu item - Decrease value

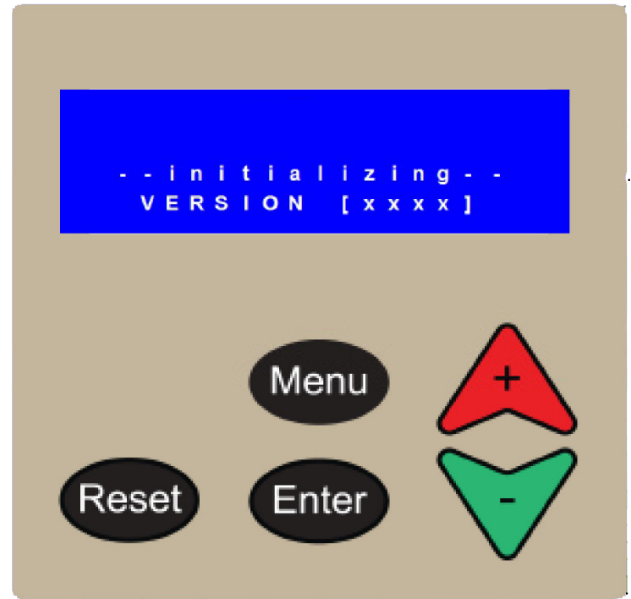

1.3 Status Indication

The following status screens can be displayed:

Boiler Status Indicator

- F = Flame Detected
- P = Central Heating System pump On
- B = Combustion Air Blower On
- S = Safety Relay Check
- G = Gas Valve Open
- D = DHW Pump On

F P B S G D
Service Reminder
Standby : No Demand
75 ° F

- Service Reminder Indicator
- Boiler in Standby Mode
- Boiler Supply Water Temperature Indicator.

Combustion Air Blower Speed Indicator

F P B G
Central Heating
65 % 95 ° F

- Boiler Running in Central Heat mode

F P B G D
Domestic Hot Water
95 % 165 ° F

- Boiler Running in DHW mode

Lockout Alarm A06
Safety Relay Error

- Lockout Alarm Indicator
Error code and short text description is displayed
Press 'Reset' key for manual reset.

Blocking Error E52
Return Sens Open

- Blocking Error in DHW
Error code and short text description is displayed Boiler automatically returns to Standby Mode when condition is eliminated.

APPENDIX A - CONTROL MODULE

1.4 Sequence of Operation





Operational State	User Interface Display	Explanation
<pre> graph TD A{Heat Demand?} -- No --> A A -- Yes --> B[DHW CH Pump on] B --> C{Supply Temperature <Setpoint?} C -- No --> A C -- Yes --> D[15 Second Prepurge] D --> E[Ignition Sparking] E --> F[After 2 seconds] F --> A </pre>	STANDBY: NO DEMAND 75 ° F	Boiler operates in standby mode until demand for Central Heat (CH) or Domestic Hot Water (DHW) is detected.
	P --- CENTRAL HEATING 0 % 75 ° F	CH or DHW pump is turned based on type of heating demand. (CH call is illustrated)
	P --- CENTRAL HEATING 0 % 75 ° F	Control Module compares supply temperature to set point. Boiler proceeds to ignition if supply temperature is less than set point.
	P B --- CENTRAL HEATING 65 % 75 ° F	Combustion Air Blower speed modulates to prepurge setting for 15 seconds.
	P B S --- CENTRAL HEATING 65 % 75 ° F	Sparking initiated sequence.

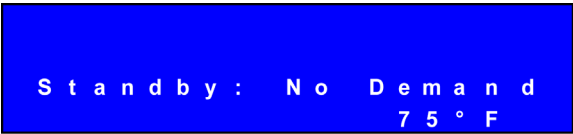

APPENDIX A - CONTROL MODULE

1.4 Sequence of Operation

Operational State	User Interface Display	Explanation
<p>After 2 seconds</p> <p>Flame Detected? Yes → Lockout Error A21</p> <p style="text-align: center;">No</p> <p>Gas Valve Energized</p> <p>After 3 seconds</p> <p>Flame Detected? No → 30 second post purge</p> <p style="text-align: center;">Yes</p> <p>Heat Demand Met?</p> <p style="text-align: center;">No</p> <p>Simultaneous DHW + CH Demand?</p> <p style="text-align: center;">Yes → DHW Priority Mode</p> <p style="text-align: center;">No</p> <p style="text-align: center;">See Max DHW Priority Time Setting</p> <p style="text-align: center;">Note: 5 Ignition trials, then Lockout A01</p>	<div style="background-color: #0000FF; color: white; padding: 5px; text-align: center;"> LOCKOUT ALARM A21 FLAME ERROR 1 </div> <div style="background-color: #0000FF; color: white; padding: 5px; text-align: center;"> P B S G _ CENTRAL HEATING 65 % 75 ° F </div> <div style="background-color: #0000FF; color: white; padding: 5px; text-align: center;"> P B S G _ CENTRAL HEATING 65 % 75 ° F </div> <div style="background-color: #0000FF; color: white; padding: 5px; text-align: center;"> F P B _ G _ CENTRAL HEATING 5 % 135 ° F </div> <div style="background-color: #0000FF; color: white; padding: 5px; text-align: center;"> F _ B _ S D DOMESTIC HOT WATER 100 % 160 ° F </div>	<p>If flame detected before Gas Valve opens during ignition boiler will lockout. Please refer to troubleshooting guide.</p> <p>Gas Valve energized to deliver air/fuel to burner.</p> <p>If flame undetected after 3 seconds boiler will de-energize Gas Valve and enter post purge mode for 30 seconds. Ignition attempted 5 times before lockout.</p> <p>Boiler will run provided all operational and safety devices are within limits. Refer to for more information. Control module adjusts firing rate according to heating demand. When Boiler detects demand met, will enter post purge mode then standby mode.</p> <p>If simultaneous demand for Central Heat and DHW, boiler will enter DHW Priority Mode. Priority mode limits amount of time boiler can run in DHW mode to meet CH demand. Max DHW Priority Time setting determines maximum time allowed for DHW heating mode. Please refer to section Appendix A section 1.5 for more information.</p>

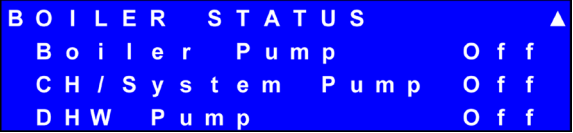
1.5 User Menu

	User Interface Display	Explanation
STANDBY		<p>Boiler operates in standby mode until demand for Central Heat (CH) or Domestic Hot Water (DHW) is detected.</p>
User Menu (Press Menu button on user interface to access User Menu)		
User Menu		<p>User Menu structure includes:</p> <ul style="list-style-type: none"> • 'Boiler Status' submenu– User can monitor general boiler status parameters such as sensor temperatures and pump operation. • 'Settings' submenu – User can view CH , adjust DHW supply water set points and also select control language. • 'Cascade Status' submenu – Boiler set to function as part of multiple boiler installation; submenu used to view runtime parameters. See Multiple Boiler Manual. (This line is not shown if boiler is not in cascade system).
Boiler Status		<p>Supply Temperature set point displayed.</p> <p>If boiler running in CH mode, CH set point displayed.</p> <p>Note:</p> <ul style="list-style-type: none"> • While running in Outdoor Reset mode, this value may change in proportion with the outdoor temperature. • If the boiler is running in DHW mode, the DHW supply set point is displayed.
		<p>Several boiler runtime parameters can be viewed while in 'Boiler Status' submenu.</p>
		<p>Operational status of pump system also shown.</p>
		<p>Information available during all states of boiler operation. Sensor values with troubleshooting tree used to diagnose typical problems.</p>

	User Interface Display	Explanation
Settings	 <p>Setting Range: 104° F to 195° F (40° C to 91° C) Default Value: 140° F (60° C)</p>	<p>Adjust CH set point to hydronic system design while in Operating in CH Mode = 0 (CH with Thermostat) or 3 (Permanent Demand).</p> <p>In CH Mode = 1 (CH with Thermostat and Outdoor Reset) or 2 (CH with Full Outdoor Reset). Display will change to 'OD Reset Setpoint' and cannot be changed. Controller calculates set point based on outdoor temperature.</p> <p>Note: For explanation of available CH heating modes, refer to 'CH Mode' section located in 'CH Settings' submenu in Installer Menu.</p>
	 <p>Setting Range: 104° F to 195° F (40° C to 91° C) Default Value: 180° F (82° C)</p>	<p>DHW set point determines supply water temperature set point while operating in DHW mode.</p>
		<p>User interface temperature unit of measure is selected using 'Change Temperature Units' screen.</p> <p>Fahrenheit and Celsius available.</p>

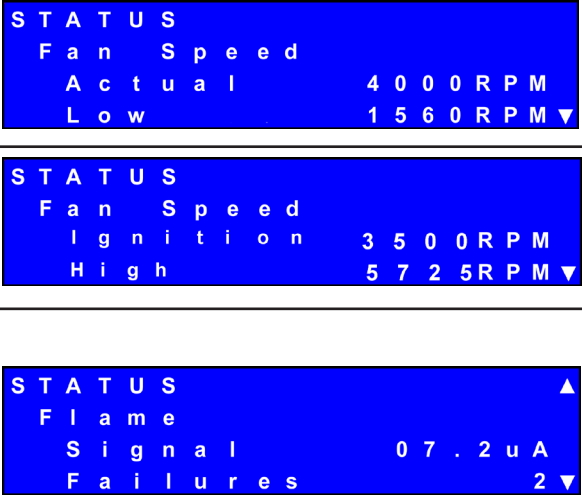
	User Interface Display	Explanation
Installer Menu		
Installer Menu		<p>Installer Menu structure includes:</p> <ul style="list-style-type: none"> • User Menu can be accessed by pressing 'Menu' key on user interface. Installer Menu can be accessed by simultaneously holding 'Menu' and 'Enter' keys for 5 seconds. • 'Boiler Status' submenu – Monitors detail boiler status parameters such as flame signal, fan speeds and stored error codes. • 'Boiler Config' submenu – Modifies general boiler settings. • 'CH Settings' submenu – Modifies advanced Central Heating settings including outdoor reset curve parameters and boost function. • 'DHW Settings' – Modifies Domestic hot Water control settings such as DHW priority time. • 'Cascade Settings' - Refer to Multiple Boiler Manual. • 'System Test' – Tool aids setup of boiler installation or diagnosis of common problems.
Boiler Status		<p>Combustion air Blower provides airflow through Combustion and Vent systems.</p> <p>Fan speed status screen indicates actual and operational fan speeds in RPM, high, low and ignition power speed settings. Settings are for information only to aid in troubleshooting.</p> <p>Boiler equipped with ionization rod to detect presence of combustion using flame rectification method. When flame is present, flame ionization rod measures small DC offset current across flame to ground (i.e. burner surface).</p> <p>'Flame' screen in 'Boiler Status' submenu displays information regarding flame ionization system; for information only and used in diagnosing combustion problems. See troubleshooting guide.</p>

	User Interface Display	Explanation
--	------------------------	-------------

Installer Menu

Boiler Status

STATUS ▲

Ignition Attempts

Successful 4267

Failed 21 ▼

Control module logs successful and failed ignition attempts. Information accessed in 'Ignition Attempts' Screen as shown.

Ignition attempts are stored in non-volatile memory and are retained in event of power failure.

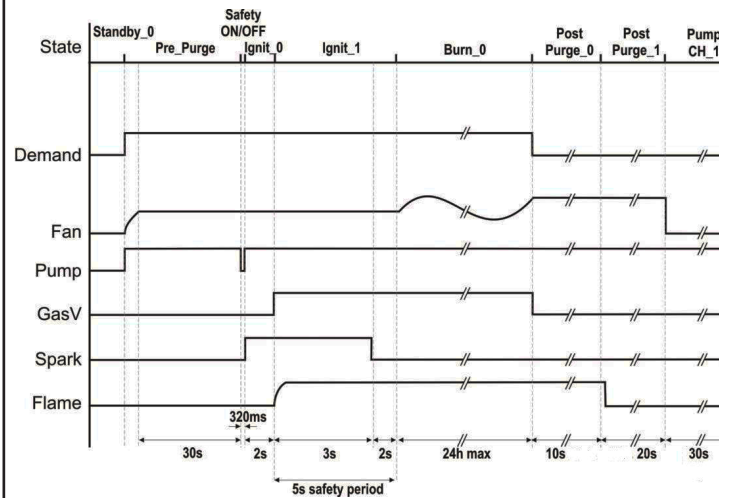

Figure A-1 Typical Ignition Cycle







Following control features are implemented to ensure safe and reliable operation of Combustion System:



False Flame Detection	If flame is detected at end of pre-spark period (Ignit_0) than lockout will occur.
Re-ignition	If at end of safety period no flame detected control will go to post-purge removing unburned gas. Re-ignition attempt started following same cycle. Number of re-ignition attempts limited to 3 after which lockout occurs.
Intermittent Operation	Boiler can be firing continuously for 24 hours. Burner switched off and restart sequence follows.
Flame out too late	If flame detected after post purge lockout follows.
Safety relay test	In Safety ON/OFF state correct operation of safety relay is proved before ignition.
UL3563 High Limit Temperature Device	Boiler comes equipped with UL353 approved temperature high limit device. Gas Valve de-energized when supply temperature exceeds 203°F lockout follows.

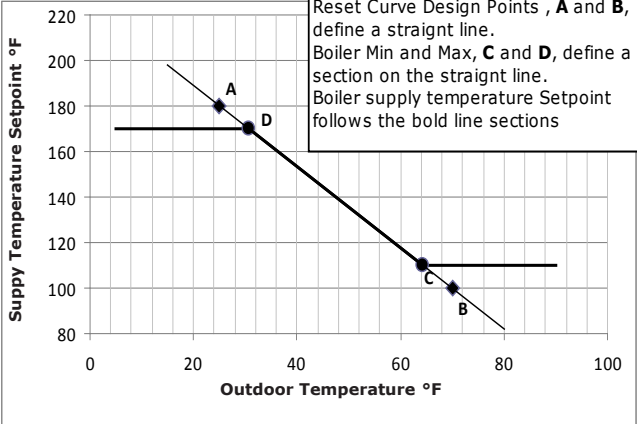

	User Interface Display	Explanation
Boiler Status	<pre> STATUS ▲ Boiler Run Time CH 3 2 0 HR DHW 1 4 5 HR ▼ </pre>	<p>Boiler stores information regarding total CH and DHW run time in hours.</p> <p>Data stored in non-volatile memory and retained in event of power failure.</p>
	<pre> STATUS # E 3 9 ▲ 2 Hrs to prev. Block Low Water Cutoff ▼ </pre>	<p>Boiler logs last 16 blocking errors and 16 lockout errors in non-volatile memory. Information retained in event of power failure.</p> <p>Most recent blocking error code and its text description displayed with elapsed time in hours since logged.</p>
	<pre> STATUS # A 0 1 ▲ 13 Hrs to prev. Lock Ignition Error </pre>	<p>Optional Computer interface Kit purchased separately to view extended error code history</p>
Boiler Configuration	<pre> BOILER CONFIG Address Selection : Boiler Address : 0 ▼ </pre>	<p>'Address Selection' screen used to set boiler position in multiple boiler cascade installation. Refer to Multiple Boiler Installation Manual.</p> <p>Default setting of '0' indicates boiler is operating in single boiler mode.</p>
	<pre> BOILER CONFIG ▲ LOW WATER CUTOFF Disabled ▼ </pre>	<p>Boiler incorporates integrated Low Water Cutoff device (LWCO) that disables boiler when low water condition exists. LWCO device located at high point of internal Heat Exchanger loop to detect low water condition.</p> <p>Detection of low water condition will result in blocking error; boiler will automatically resume normal operation when proper water level returns. Refer to Troubleshooting Guide.</p> <p>LWCO device can be disabled for diagnostic purposes or where applicable code permits.</p>

	User Interface Display	Explanation
<p style="writing-mode: vertical-rl; transform: rotate(180deg);">Boiler Configuration</p>	 <pre> BOILER CONFIG ▲ Pump Mode MODE: 0 CH or CH&DHW ▼ </pre>	<p>Two pump modes are available:</p> <p>1. Pump Mode = 0 'CH or CH&DHW'</p> <ul style="list-style-type: none"> In this mode either CH or DHW pump terminal is energized depending on type of demand (CH or DHW). CH and DHW pumps are never energized at the same time. In the case of simultaneous call for both CH and DHW, the energized pump depends on whether the boiler is currently supplying CH or DHW demand. Refer to DHW Priority settings below. This is typical of hydronic system design with separate CH and DHW Pumps. <p>2. Pump Mode = 4 'System Pump'</p> <ul style="list-style-type: none"> In this mode only one external system pump is installed in hydronic system. This pump will energize independent of type of demand (CH or DHW). Connect this pump to CH/System Pump electrical terminal block. See page 35 for diagram. DHW pump terminal does not function. This is typical of hydronic system design which utilizes zone valves for all CH zones and DHW indirect tank. <p>Note:</p> <ul style="list-style-type: none"> Pump Mode selection depends on electrical and hydronic system design. Please refer to sections 5 and 8 for recommended hydronic piping and electrical configurations. Internal heat exchanger pump is energized anytime demand exists regardless of Pump Mode setting or type of demand (CH or DHW).
	 <pre> BOILER CONFIG ▲ SERVICE REMINDER Status On Reminder 365 days </pre>	<p>'Service Reminder' feature allows the installer to enable or disable a service reminder notification on the User Interface at a predefined interval .</p> <p>Service reminder does not affect operation of boiler in any way. It is only a reminder to End User that routine preventative maintenance is required by qualified service technician.</p> <p>Allowed Range: 1 to 999 days</p>

	User Interface Display	Explanation
<p>CH Settings</p>	 <p>The screenshot shows a blue background with white text. The top line reads 'CH SETTINGS'. The second line reads 'CH mode MODE: 1'. The third line reads 'CH with thermostat' followed by a downward-pointing triangle.</p>	<p>4. Central Heating (CH) modes available:</p> <ul style="list-style-type: none"> ● CH Mode = 0 'CH with Thermostat' <ul style="list-style-type: none"> • Boiler will attempt to satisfy CH demand while CH thermostat input is closed. • Boiler will modulate its firing rate to maintain CH set point and match system heat load. • CH set point adjusted in 'Settings' submenu under 'User Menu' ● CH Mode = 1 'CH with Thermostat and Outdoor Reset' <ul style="list-style-type: none"> • Boiler will attempt to satisfy CH demand when CH thermostat input is closed. • Boiler will modulate its firing rate to maintain CH set point and match system heat load. • CH set point calculated as function of outdoor temperature using outdoor reset curve. See figure A-2 ● CH Mode = 2 'CH with Full Outdoor Reset' <ul style="list-style-type: none"> • CH demand is determined by outdoor temperature and Warm Weather Shutdown temperature. • Boiler will permanently attempt to satisfy CH demand, when CH demand is available. • CH thermostat input is ignored. • CH set point calculated as function of outdoor temperature using outdoor reset curve. See figure A-2 ● CH Mode = 3 'CH with Permanent Demand' <ul style="list-style-type: none"> • CH demand is permanently on. • Boiler will permanently attempt to satisfy CH demand. • CH thermostat input is ignored. • CH set point is adjusted in 'Settings' submenu under 'User Menu' <p>Note:</p> <ul style="list-style-type: none"> • Once CH demand is satisfied (i.e. CH thermostat opens or boiler determines its minimum firing rate exceeds system heating load): <ul style="list-style-type: none"> • Burner shuts off, boiler enters post purge. • CH pump continues to run for 30 seconds. • Control will wait until Anti-cycle time of 180 seconds elapses before boiler fires again. Prevents short-cycling. • The internal heat exchanger pump is energized anytime demand exists regardless of Pump Mode setting or type of demand (CH or DHW).

	User Interface Display	Explanation
CH Settings	 <p>Allowed Range: 35°F to 100°F (2°C to 38°C) Default Setting: 70°F (21°C)</p>	<p>If outdoor temperature is greater than Warm Weather Shutdown Temperature, demand for CH blocked and pumps stopped.</p>
	 <p>Allowed Boiler Range: 60°F to 195°F (40°C to 91°C) Default Boiler Setting: 180° F (82°C)</p>	<p>Boiler capable of operating in Outdoor Reset Mode when included Outdoor Sensor is connected and proper CH Mode selected.</p> <p>If CH Mode = 1, 'Outdoor Temperature Reset with Thermostat' or 2, 'Full Outdoor Reset' boiler will adjust CH set point proportional to outdoor temperature as defined by Outdoor Reset Curve below.</p> <p>Outdoor reset curve adjusted by modifying Design and Mild Weather reference temperatures. See points A & B of Reset Curve below.</p>
	 <p>Allowed Boiler Range: 35°F to 120 F (2°C to 49°C) Default Boiler Setting: 100°F (37°C)</p> <p>Allowed Outdoor Range: 35°F to 85°F (2°C to 29°C) Default Outdoor Setting: 70°F (21°C)</p>	<p>Calculated CH set point always limited between 'Reset Curve Boiler Minimum/Maximum' temperatures. See points C & D of Reset Curve below.</p>
	 <p>Allowed Min. Range: 40°F to 180°F (4°C to 82°C) Default Min. Setting: 70°F (21°C)</p> <p>Allowed Max. Range: 80°F to 195°F (27°C to 91° C) Default Max. Setting: 180°F (82°C)</p>	<p>Figure A-2 Outdoor Reset Curve Calculated supply temperature follows thick black line in graph above based on outdoor temperature.</p>  <p>Note:</p> <ul style="list-style-type: none"> • Modes only function when outdoor temperature sensor connected. • If 'Open' outdoor sensor detected CH set point equal to 'Boiler Reset Curve Design' temperature. • Outdoor temperature used for CH set point calculation measured once a minute and averaged with previous measurement to compensate for rapid outdoor temperature variations.

	User Interface Display	Explanation
CH Settings		<p>Outdoor reset boost function increases CH set point by increment ('Temp') if CH demand continues beyond pre-set time limit ('Time').</p> <p>CH set point will continue to increase until set point reaches 195°F / 91°C</p> <p>Allowable Temperature Increment: 0..36 °F (0..20 °C) Default Temperature increment: 0 °F (10 °C)</p> <p>Allowable Time Delay: 1..120 minutes Default Time Delay: 20 minutes</p>
		<p>Maximum boiler power in CH mode limited by adjusting 'Maximum Power CH' setting. Boiler will not exceed this value while operating in CH Mode.</p> <p>Allowable Range: 1..100% Default Setting: 100%</p>
DHW Settings		<p>Two DHW modes are available</p> <ul style="list-style-type: none"> • DHW Mode = 0 'No DHW' <ul style="list-style-type: none"> • DHW Mode is disabled • The DHW thermostat input is ignored and the DHW pump is not used. • DHW Mode = 2 'DHW Store with Thermostat' <ul style="list-style-type: none"> • Boiler reacts to DHW demand when DHW thermostat input closes. • Boiler modulates to meet DHW demand similar to CH Mode except DHW set point is used. DHW set point set in Settings' submenu found in 'User Menu'. • Simultaneous CH & DHW demands handled using DHW Priority Timing. See 'DHW Maximum Priority Time' setting below. <p>Note:</p> <ul style="list-style-type: none"> • Outdoor reset function disabled while operating in DHW Mode. • Typical when using a DHW indirect storage tank. • After DHW demand satisfied, boiler enters post purge mode and DHW pump continues to run for 15 seconds.

	User Interface Display	Explanation
DHW Settings	 <p>Allowed Range: 1 to 60 Minutes Default Setting: 30 Minutes</p>	<p>Maximum time boiler operates in DHW mode limited by DHW Maximum Priority Time Setting.</p> <p>Priority timer starts when both CH and DHW demand is present. Boiler will switch from DHW back to CH operation after Maximum Priority Time has elapsed.</p> <p>CH demand then has priority until Maximum Priority Time has elapsed.</p> <p>Process repeats until either CH or DHW demand satisfied.</p>
System Test	 	<p>System test can be activated via installer menu for testing system at fixed power rates.</p> <p>Boiler can be started without CH or DHW demand being present. System Test has priority over any system demand while test mode activated.</p> <p>System test mode automatically ends after 30 minutes boiler resumes normal operation.</p> <p>The following modes are available:</p> <ul style="list-style-type: none"> • Disabled • Low power - Burner starts. After ignition period has finished the burner stays at low power • Ignition power - Burner starts. Stays at ignition power • High power - Burner starts. After ignition period has finished burner stays at high power. <p>Note:</p> <ul style="list-style-type: none"> • Before running system test modes, check if hydronic system capable of dissipating heat. • Both heat exchanger and CH pumps are activated during system test. • During System Test Mode, boiler will run at fixed power rates until supply water temperature is 93°C/195°F • All other safety functions remain active while in System Test Mode.

97_{gb}

IMPORTANT

In accordance with Section 325 (f) (3) of the Energy Policy and Conservation Act, this boiler is equipped with a feature that saves energy by reducing the boiler water temperature as the heating load decreases. This feature is equipped with an override which is provided primarily to permit the use of an external energy management system that serves the same function.

THIS OVERRIDE MUST NOT BE USED UNLESS AT LEAST ONE OF THE FOLLOWING CONDITIONS IS TRUE:

- An external energy management system is installed that reduces the boiler water temperature as the heating load decreases.
- This boiler is not used for any space heating
- This boiler is part of a modular or multiple boiler system having a total input of 300,000 BTU/hr or greater.
- This boiler is equipped with a tankless coil.



ECR international
EST. 1928
A Family of Heating & Cooling Brands.

ECR International, Inc
2201 Dwyer Avenue, Utica NY 13501

web site: www.ecrinternational.com

P/N 240008282 Rev. L [02/15/2017]