

**DO NOT DISCARD INSTRUCTIONS. THIS MANUAL MUST REMAIN WITH THE UNIT FOR FUTURE REFERENCE.
THIS EMERGENCY INFORMATION MUST BE PROMINENTLY DISPLAYED.**

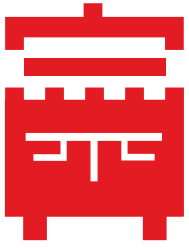

TOWN

發富公司

FOOD SERVICE EQUIPMENT CO., INC.
72 BEADEL STREET BROOKLYN, NY 11222

800/221.5032 718/388.5650 718/388.5860 customerservice@townfood.com www.townfood.com



EcoDeck



MASTERRANGE



York



CHINESE WOK RANGE OWNER'S MANUAL SECTION 1 INSTALLATION INSTRUCTIONS



When sold in the Commonwealth of Massachusetts this unit must be equipped with an interlock to prevent operation only if the hood system is operational. Installation of the interlock is the responsibility of the installer—it is not supplied by the factory.

WARNING

Improper installation, adjustment, alteration, service or maintenance can cause property damage, injury or death.

Read the installation, operating and maintenance instructions thoroughly before installing or servicing this equipment.

FOR YOUR SAFETY

Do not store or use gasoline or other flammable vapors and liquids in the vicinity of this or any other appliance.

IMPORTANT

Contact your local gas supplier for instructions if you smell gas near this equipment.



EcoDeck



MASTERRANGE



York



MASTERRANGE

FOR THE PROFESSIONAL THERE IS NO EQUAL



York

CUSTOM AT STANDARD PRICES



YORK AND MASTERRANGE PARTS IDENTIFICATION

- | | |
|---|---|
| A REMOVABLE FLUE RISER CAP | H CANTONESE CHAMBER RING |
| B BACK SPLASH | I PLATE SHELF |
| C SWING FAUCET | J WATER WASH CONTROL VALVE |
| D 3 PIPE WOK COVER/STRAINER RACK | K DRIP TRAY |
| E MANUAL FAUCET | L PILOT LIGHT CONTROL VALVE |
| F SIDE SPLASH | M KNEE OPERATED GAS VALVES |
| G MANDARIN CHAMBER RING | N FRONT ACCESS SINK (WASTE) BASKET |



**EcoDeck****MASTERRANGE****York**

CONGRATULATIONS ON YOUR PURCHASE OF A ECODECK, YORK OR MASTERRANGE WOK RANGE

It will give you many years of trouble free use if it is properly used and maintained. Please call our customer service department at 718/388-5650 if you have questions regarding equipment operation or care.

Your range has been carefully engineered and constructed with the best possible workmanship and materials to provide many years of satisfactory service. Proper installation is vital if best appearance and performance is to be achieved.

STOCKPOT AND WOK TOP RANGE INSTALLATION INSTRUCTIONS

FOLLOW THESE INSTRUCTIONS CAREFULLY
INSTALLATION AREA MUST BE FREE AND CLEAR FROM COMBUSTIBLES

POSITIONING

- 1) Position crate in approximate location that the unit will occupy. Uncrate range and locate sealed cartons on the range top containing the following accessories: (1) set of adjustable legs or casters if ordered; (1) drip pan for each chamber; (1) extension chimney for each opening in return splash if your unit is equipped with a flue riser; and (1) gas pressure regulator. Find the legs and set one leg by each range gusset into which it will be inserted. Raise 1 end of the unit at a time; insert legs; and tighten set screws with 1/4" Allen wrench. If your range has flue risers, slip the extension chimney over each riser.
- 2) Range is now ready for final positioning. Carefully lift range into desired position to avoid damage to adjustable legs. Clearances from combustible construction are 6" at rear and sides. Remove burner tie wires and other packing materials. Check gas burners that may have shifted in transit and center them by eye if required. Turn all gas valve lever handles to off (horizontal) position. Check air mixer alignment to gas burner nipple and tighten set screws if necessary.
- 3) Clearances for noncombustible construction are the same as combustible clearances. This range is for installation only on noncombustible floors.

INSTALLATION

- The gas supply line must be of adequate size to ensure maximum efficiency of the unit.
- The installation must conform with the National Fuel Gas Code, ANSI Z223.1, Natural Gas Installation Code, CAN/CGA-B149.1 or the Propane Installation Code, CAN/CGA-B149.2, as applicable, including:
 - a) The appliance and its individual shutoff valve must be disconnected from the gas supply piping system during any pressure testing of that system at test pressures in excess of 1/2 PSI (3.45 kPa).
 - b) The appliance must be isolated from the gas supply piping system by closing its individual manual valve during any pressure testing of the gas supply piping system at test pressures equal or less than 1/2 PSIG (3.45 kPa).
- Local regulations governing gas appliance installations must be complied with.
- Equipment should be under hood with adequate ventilation.



- The unit must be installed in an area or room with sufficient fresh air supply to ensure proper combustion.
- There must be adequate clearance for air openings into the combustion chamber.
- This equipment must be installed with adequate clearance for servicing and proper operation.
- This unit should be operated only with drip trays in place.
- Use of the supplied gas pressure regulator is mandatory.
- The front of the unit must be kept clear to avoid restriction of air supply for proper combustion.
- If your unit is supplied with casters, the installation shall be made with a connector that complies with the standard for connectors for Movable Gas Appliances, ANSI Z21.69 or connectors for Moveable Gas Appliances, CAN/CGA-6.16, and a Quick-Disconnect Device that complies with the standard for Quick-Disconnect Devices for use with gas fuel ANSI Z21.41, or Quick-Disconnect Devices for use with Gas fuel, CAN1-6.9, and adequate means must be provided to limit the movement of the appliance without depending on connector and the Quick-Disconnect Device or its associated piping to limit the appliance movement.
- If your unit is provided with casters on legs, the legs with locking casters must be installed in front of the unit. An approved restraining device must be secured to the unit's rear or side.

IMPORTANT INFORMATION ABOUT WATER AND GAS SETUP

1) BURNERS AND FAUCETS

Remove any nylon hold-downs on the faucets. The burners may also have hold-downs and may have shifted during shipping. Remove the nylon hold-downs and center the burner in the chamber. Tighten clamps as necessary.

2) WATER-PRESSURE REGULATOR

This wok range has a pre plumbed water pressure regulator/ flow restrictor. It is factory set for 50 PSI outlet. This is done to conserve water and prevent water from the cooling spray bar from splashing over the side of the range causing a "leak". When installed, the water flow from the cooling line and the faucets must be checked for adequate flow. If the water pressure is low at the installation site the regulator must be adjusted to increase the water flow. (Please refer to the attached instruction sheet for information on how to adjust the regulator) With spray bar valve on you should observe a constant flow of water from spray bar that fully covers the entire deck. This applies to all rear and front gutter units except EcoDeck
 Note: if water pressure is high, the regulator may need to be adjusted to LOWER the pressure.

Clockwise more pressure counterclockwise less pressure

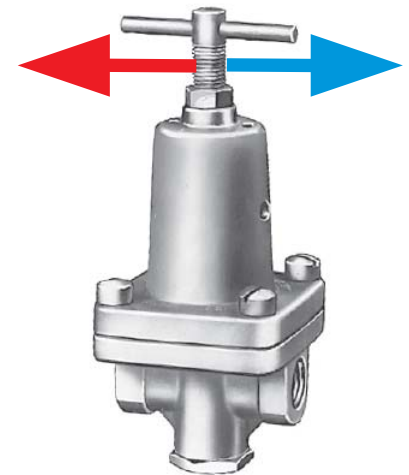

**LF26A
2-Way**



3) **WATER AND DRAIN**

Check that all faucets work. If it is a Chinese style swing faucet, move the faucet perpendicular to the backsplash to check for water flow. Turn on the water wash and verify that water flows and washes the entire deck surface. Verify that the water flow covers the entire top deck and the backsplash- if a front gutter, waterfall backsplash design. Level as necessary to ensure even water flow across the deck by adjusting bullet legs to position and control pitch of deck. Refer to item # 2 if water flow needs to be adjusted due to pressure.

4) **PILOTS**

After the unit has been connected by the licensed plumber and has passed local inspection, turn gas on and light all of the pilots. In a standing pilot, light each pilot and adjust flame using the pilot gas valve supplied for each chamber. The pilot valve is the small brass fitting with a small brass hex screw and is located on each manifold burner gas riser. Using a jeweler's screwdriver, turn clockwise to decrease the flame and counter clockwise to increase the flame. Do not remove the screw. If a safety pilot, there will be a small control in the front panel for each chamber with a red button. Follow the instructions in the owner's manual for startup using safety pilots. The burners will not light if the safety pilots are not lit first.

5) **PILOT SAFETY SYSTEM**

The Pilot safety system utilizes a thermocouple. The thermocouple connection must be clean and tight. This unit is shipped with the thermocouple(s) connected and properly tightened. Connection cannot be too tight or the grey bulb (positive connection) will break off. Check that the grey bulb is free of corrosion, clean with fine grit sandpaper if necessary. Hand tighten the hex fitting, then using a wrench tighten the hex nut an additional ¼ turn clockwise. If you over tighten the hex nut the bulb will break off.

6) **GAS REGULATOR**

The supplied appliance regulator has a maximum continuous rated input of 15" WC (approx. 0.5psig). The supplied regulator must be installed on all Town wok ranges. Do not overpressure the regulator. If your natural gas system is a 2-5 PSI system you need to have a 1st stage line regulator (supplied by others) installed upstream of our appliance

7) **GAS FEED**

If the manifold piping and final connection piping are not properly sized the equipment will not function at optimal levels. Consult with your plumber or LPE to insure that the pipe sizing is correct. We do not recommend Flex type (quick disconnect) hoses for use with the woks. If selected, the flex should be sized to flow the rated gas input capacity. The maximum flex hose length should be 36" and be without any swivel connectors.



UNITS WITHOUT SAFETY VALVES LIGHTING AND SHUT DOWN INSTRUCTIONS

Be sure that all piping is gas tight and that all air is purged from lines. With main burner valve in **off** position (figure 3), using a screw driver turn pilot screw counter clockwise to **on** (figure 2) and light pilot located in the combustion chamber. Make sure the pilot stays lit.

All units are equipped with fixed orifices which cannot be adjusted for gas flow. Only ring burners have adjustable air mixers to adjust the air/gas mixture.

Turn right hand burner valve to full **on** position (figure 3) and adjust air shutter until proper blue flame is burning on both inner rings. Repeat operation for left hand valve only if your range is equipped with 3 ring burners.

SHUTDOWN

Turn burner valves to **off** position (figure 3) and turn the pilot screw clockwise (figure 2) until it cannot be turned further. Repeat this step for each chamber.

INSTALLATION AREA MUST BE FREE AND CLEAR FROM COMBUSTIBLES
LOCAL SAFETY CODES SHOULD BE COMPLIED WITH IN RESPECT TO FIRE AVOIDANCE

put lit match to pilot burner, depress and hold red button

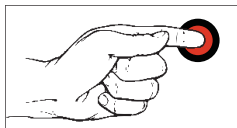

figure 1
SAFETY PILOT BUTTON

ON position
turn clockwise until screw cannot be turned

OFF position
turn counter-clockwise

pilot screw

figure 2
PILOT VALVE

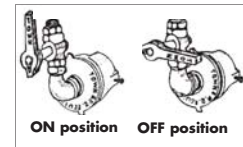

figure 3
MAIN BURNER VALVE

AIR SHUTTER
(ring burners only)

UNITS WITH SAFETY VALVES LIGHTING AND SHUT DOWN INSTRUCTIONS

Always follow these lighting and shutdown instructions when operating your unit.

A 5 minute complete shutoff period is required before lighting or relighting pilot. See diagrams above.

- 1) Check that all gas valves on the unit are turned **off** (lever handles in horizontal position) before turning **on** main gas line. Check for leaks using soapy water or other suitable leak detector.
DO NOT USE OPEN FLAME FOR TESTING
- 2) Main burner valve should be in **off** position (figure 3). Place a burning match by the pilot burner in the combustion chamber of the range. Depress red safety pilot button on (figure 1) and light pilot.
- 3) The pilot should light. Continue to hold the button for 1 minute or until the pilot stays lit.

TEMPORARY AND EXTENDED SHUTDOWN

For temporary shut down turn all burner valves to **off** position.

For an extended period of time, turn all burner valves **off** and also turn off gas supply to the range.



BACKSPLASH REMOVAL AND REINSTALLATION

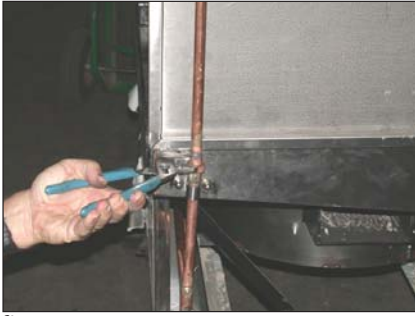

figure 1



figure 2

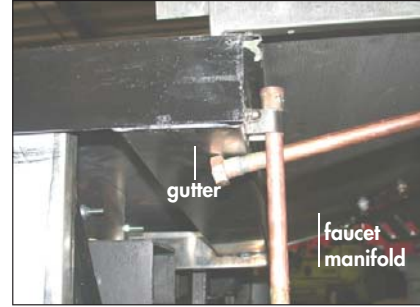

figure 3



figure 4



figure 5



figure 6



figure 7

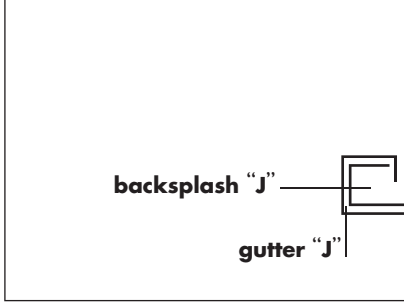

figure 8

Some installations require the backsplash to be removed so the range can fit through a 34" door. Town ranges are manufactured with removable backsplashes. Follow these steps to remove backsplash:

- 1) Loosen union at backsplash (figure 1).
- 2) Remove sidesplash bolts and lower backsplash (figure 2).
- 3) Faucet manifold must be placed below gutter (figure 3)
- 4) Lower backsplash until sidesplash clears gutter (figure 4).
- 5) Sidesplash may be removed. Range will fit through 34" opening (figure 5).
- 6) Reinsert sidesplash and backsplash into gutter. Ensure backsplash "J" hooks in to the gutter "J" (figure 6).
- 7) Raise backsplash, making sure it is locked into the gutter "J" (figure 7).
- 8) When raised, the gutter and backsplash should be aligned. Bolt side splashes to body (figure 8).

FLUE RISER EXTENSION INSTALLATION (NEW VERSION ON UNITS SHIPPED AFTER JUNE 2005)

Ranges with optional Flue Risers have stainless steel extensions that cover the tops of the flue risers. Locate the parts in the boxed marked "RANGE ACCESSORIES".

- 1) Take assembled flue collar and turn with kink to rear (figure A).
- 2) Place flue collar on top of chimney extension as illustrated (figure B).
- 3) Catch front return beneath slot in backsplash (circled in figure C).
- 4) Snap kinked end into slot (figure D).



figure A

KINK



figure B

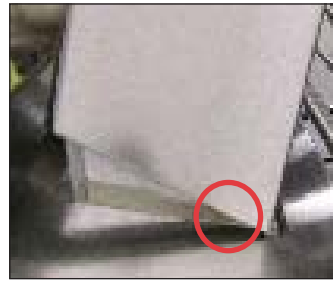

figure C



figure D

FIELD JOINT INSTALLATIONS

The optional field joint joins two or more ranges. It must be ordered when the ranges are built. It cannot be added to existing ranges. A butt field joint has a standing seam between ranges while a splice field joint gives a smooth fit.

BUTT FIELD JOINT INSTALLATION INSTRUCTIONS

Each range has a vertical seam at the joint between the ranges. The backsplashes will be joined.

- 1) Uncrate the ranges and install legs onto the gussets. Secure legs with the gusset set screw.
- 2) Carefully locate the battery into final location. Align the sides to be joined. The battery was assembled at the factory to assure good fit. Pitched floors will add difficulty to battery assembly (figures 1 and 2).
- 3) Align the backsplashes. It may necessary to level the range so the backsplashes meet at top. Insert and slide down the "U" shaped joiner until it is level with the top of the backsplash (figures 3 and 4).



figure 1



figure 2

- 4) Install the stainless tubular wok cover rack. Male and female ends mate to become a continuous length. Remove the bolts from the brackets and install the tubing with threaded ends. Use the bolts removed from the brackets at the endsplashes. (figures 5, 6 and 7).
- 5) The range position may have to be adjusted to align the bolt holes in the serving shelf with the tapped holes provided for them (figures 8 and 9).
- 6) Pitch the range using the adjustable bullet feet so that water flows off the top of the range.
- 7) Connections can be made by authorized personnel. Each range has gas, waste and water connections.



figure 3



figure 4



figure 5



figure 6



figure 7



figure 8

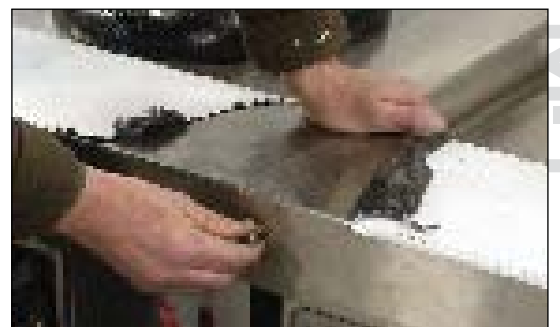

figure 9

SPLICE FIELD JOINT INSTALLATION INSTRUCTIONS

Range decks have a “tongue and groove” so there is no standing seam between range decks. The decks and backsplashes are joined. The gutters are separate but interlock.

- 1) Uncrate the ranges and place them on pallet jacks. Be careful to position jacks away from drip pan guides.
- 2) Install the legs onto each range. Secure legs with the set screw in the gusset.
- 3) Remove the front body panels. Figure 1 shows a detail of front right corner of a range with the body front panel removed.
- 4) Carefully move the ranges to their final location. Position the ends to be joined next to each other. The battery was assembled at the factory to assure good fit. Pitched floors will add difficulty to battery assembly.
- 5) Generously apply silicon to the groove below the stainless steel deck. Apply additional silicon to the tongue of the other range that will fit into this groove. Figure 2 shows the groove.
- 6) Insert the tongue into the groove and slide the ranges together as shown in figure 3.
- 7) Be certain that the range with an extension on its gutter overlaps the gutter of the adjoining range as shown in figure 4.
- 8) Locate the bolt holes in the range body as shown above in figures 4 and 5 and bolt the range bodies together.
- 9) Silicon the front seam of range decks in the circled area of figure 6.
- 10) Align the backsplashes. It may necessary to level the range so the backsplashes meet at top. Insert and slide down the “U” shaped joiner until it is level with the top of the backsplash. See figures 7 and 8.
- 11) Install the three stainless steel tubes of the wok cover rack. **Note**—there are male and female ends that mate to become a continuous length.
- 12) Pitch the range using the adjustable bullet feet so that water flows off the top of the range.

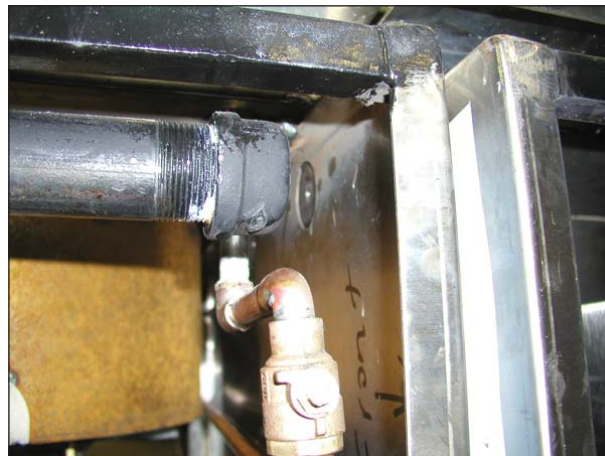

figure 1



figure 2



figure 3



figure 4



figure7



figure 5

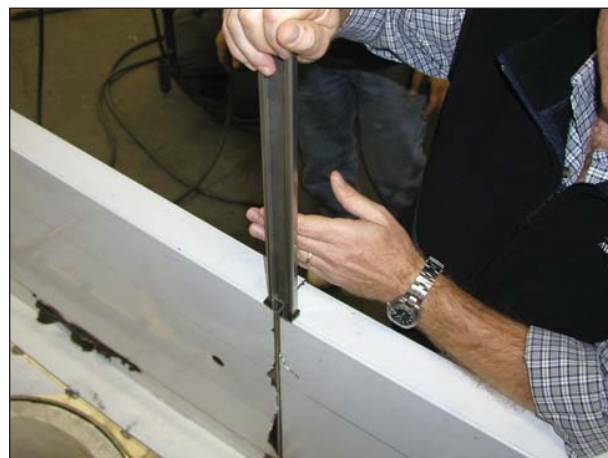

figure 8



figure 6

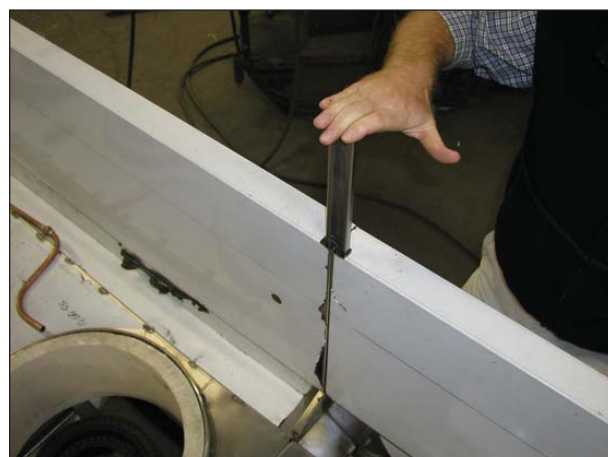
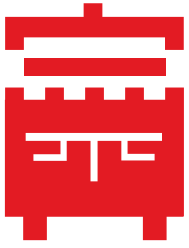

figure 9



**DO NOT DISCARD INSTRUCTIONS. THIS MANUAL MUST REMAIN WITH THE UNIT FOR FUTURE REFERENCE.
THIS EMERGENCY INFORMATION MUST BE PROMINENTLY DISPLAYED.**



TOWN

發富公司

FOOD SERVICE EQUIPMENT CO., INC.
72 BEADEL STREET BROOKLYN, NY 11222

800/221.5032 718/388.5650 718/388.5860 customerservice@townfood.com www.townfood.com



EcoDeck



MASTERRANGE



York



CHINESE WOK RANGE OWNER'S MANUAL SECTION 2 OPERATING AND MAINTENANCE INSTRUCTIONS



When sold in the Commonwealth of Massachusetts this unit must be equipped with an interlock to prevent operation only if the hood system is operational. Installation of the interlock is the responsibility of the installer—it is not supplied by the factory.

WARNING

Improper installation, adjustment, alteration, service or maintenance can cause property damage, injury or death.

Read the installation, operating and maintenance instructions thoroughly before installing or servicing this equipment.

FOR YOUR SAFETY

Do not store or use gasoline or other flammable vapors and liquids in the vicinity of this or any other appliance.

IMPORTANT

Contact your local gas supplier for instructions if you smell gas near this equipment.

UNITS WITHOUT SAFETY VALVES LIGHTING AND SHUT DOWN INSTRUCTIONS

Be sure that all piping is gas tight and that all air is purged from lines. With main burner valve in **off** position (figure 3), using a screw driver turn pilot screw counter clockwise to **on** (figure 2) and light pilot located in the combustion chamber. Make sure the pilot stays lit.

All units are equipped with fixed orifices which cannot be adjusted for gas flow. Only ring burners have adjustable air mixers to adjust the air/gas mixture.

Turn right hand burner valve to full **on** position (figure 3) and adjust air shutter until proper blue flame is burning on both inner rings. Repeat operation for left hand valve only if your range is equipped with 3 ring burners.

SHUTDOWN

Turn burner valves to **off** position (figure 3) and turn the pilot screw clockwise (figure 2) until it cannot be turned further. Repeat this step for each chamber.

INSTALLATION AREA MUST BE FREE AND CLEAR FROM COMBUSTIBLES
LOCAL SAFETY CODES SHOULD BE COMPLIED WITH IN RESPECT TO FIRE AVOIDANCE

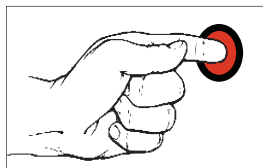

figure 1
SAFETY PILOT BUTTON

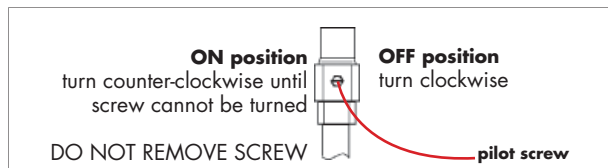

figure 2
PILOT VALVE

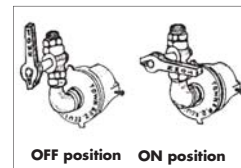

figure 3
MAIN BURNER VALVE
AIR SHUTTER (ring burners only)

UNITS WITH SAFETY VALVES LIGHTING AND SHUT DOWN INSTRUCTIONS

Always follow these lighting and shutdown instructions when operating your unit. A 5 minute complete shutoff period is required before lighting or relighting pilot. See diagrams above.

- 1) Check that all gas valves on the unit are turned **off** (lever handles in horizontal position) before turning **on** main gas line. Check for leaks using soapy water or other suitable leak detector.
DO NOT USE OPEN FLAME FOR TESTING
- 2) Main burner valve should be in **off** position (figure 3). Place a burning match by the pilot burner in the combustion chamber of the range. Depress red safety pilot button on (figure 1) and light pilot.
- 3) The pilot should light. Continue to hold the button for 1 minute or until the pilot stays lit.

TEMPORARY AND EXTENDED SHUTDOWN

For temporary shut down turn all burner valves to **off** position.
For an extended period of time, turn all burner valves **off** and also turn off gas supply to the range.

IMPORTANT INFORMATION ABOUT WATER AND GAS OPERATION

1) GAS VALVE

- Turn on the "L" handle gas valve using your knee or hand. The valve is fully open when the valve is pointing straight up at the 12 o'clock position.
- Jet type burners have only one valve per chamber.
- For a three ring burner there is a master "L" valve and two shorter straight handle valves. The "L" valve controls the gas flow for both sub valves, while each sub valve controls either the inner or outer ring. Turn on the main "L" valve and then set the two sub valves for the flame desired. You can leave them at this setting and use the "L" valve to turn the burner on and off.
- When the valve(s) are fully open most if not all of the jet tips or port orifices should light. Do not be concerned they all do not light immediately. The burners need the backpressure of the wok for all the jets to light.

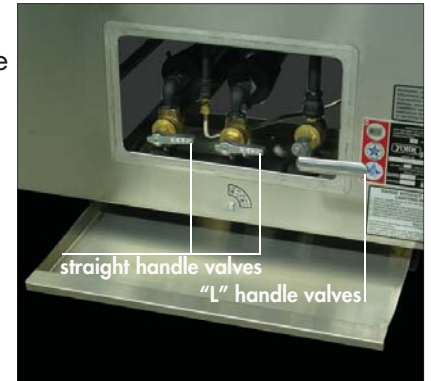

2) WATER AND DRAIN

When the wok is in operation be sure that the water cooling line is running. Failure to do so will cause the deck top to overheat and possibly warp. For a standard rear gutter unit, the water will wash from the front to the back (and from the top of the backsplash if a waterfall backsplash option is included). For a front gutter unit, the water will flow from the top of the backsplash to the front of the unit.

3) SHUTDOWN

At the end of service shut off all the burners, but leave the water on for several minutes, to wash away remaining food scraps and cool the unit. Leave both standing and safety pilots lit.

MAINTENANCE AND CARE

- If equipment requires service, contact your authorized gas service company to perform necessary repairs.
- Check the flue riser monthly to be sure it is free of obstructions. Be sure to clean the air mixers and orifices of ring burners once a year. Jet and shield tip burners must be serviced more often as they become clogged more easily. This service must be performed by a qualified gas service company.
- Range should be cleaned each evening with grease dissolver and rinsed well. It will prevent grease accumulation and keep the unit clean and sanitary.
- If unit is supplied with casters, there should be a restraint on the appliance to limit its movement. If disconnection of the restraint becomes necessary, it is imperative that the restraint be reconnected after the appliance is returned to its originally installed position.

MAINTENANCE AND CARE

THE FOLLOWING SERVICE SHOULD BE DONE ONLY BY A QUALIFIED GAS SERVICE TECHNICIAN

CHANGING THE PILOT LIGHT IN A CHAMBER WITH A RING BURNER OR SHIELD TIP BURNER

Shut off pilot valve. The pilot light is mounted on flexible tubing and can be raised. Using a 12mm open-ended wrench, hold the center of the compression fitting below the pilot firm.

Using a 1/2" wrench, unscrew the pilot from its brass fitting at bottom. Install the new pilot by reversing the above procedure. Adjust the pilot flame at the pilot valve and be sure to check for gas leaks using a soapy solution.

CHANGING THE PILOT LIGHT IN A CHAMBER WITH A JET BURNER

Shut off pilot valve. Using a 12mm open-ended wrench, unscrew the pilot, remove and replace. If a 12mm open-ended wrench is unavailable, a 1/2" open end or adjustable wrench may suffice.

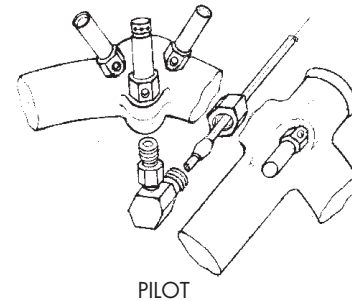
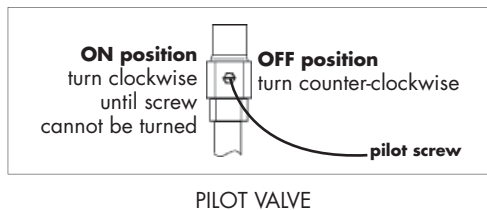

FLUE COLLAR REPLACEMENT ("F" MODELS)

The cast iron flue collar may deteriorate after considerable use. If deterioration is detected, we suggest you contact your local service company for replacement parts and qualified service. If you must replace the flue collar yourself, follow the instructions below:

SHUT OFF GAS TO RANGE BEFORE MAKING ANY ADJUSTMENTS

THE BURNER AND PILOT MUST BE REMOVED BEFORE REMOVING THE FLUE COLLAR

- 1) Remove old nuts behind range that secure flue collar (1).
- 2) Remove worn collars with pry bar (2).
Put new collar into place using provided hardware.
Re-cement chamber and replace burner and pilot.

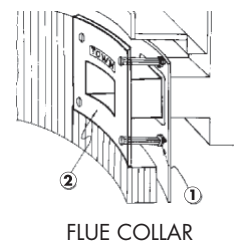

Robertshaw

Robertshaw

CONTROLS COMPANY
Uni-Line Division



1720 (TS)

ELECTROMAGNET REPLACEMENT KIT

TS AUTOMATIC SAFETY VALVES FOR MODEL 1710 BODY TYPES #9, 10, 11 AND 12 ONLY

1. Turn off all gas supply to equipment being serviced.
2. Disconnect thermocouple. Note location and direction of thermocouple connection.
3. Disconnect pilot gas tubing on models with a pilot inlet and/or outlet.
4. Remove the four Phillips head screws that attach magnet head to valve body. Discard these screws.
5. Remove and discard the following:
 - A. Magnet head assembly
 - B. Diaphragm (Note: Not all models have this thin metal piece.)
 - C. All gaskets
 - D. Main valve — Also discard valve spring on flow interruption models.
6. Install new kit parts as follows:
 - A. Valve and spring assembly, with large end of spring against top of valve.
 - B. Gasket — position gasket to align with mounting surface on valve body.
 - C. Replacement Magnet Head, with thermocouple connection matching location on old head. **NOTE:** Be certain valve spring contacts bottom of magnet stem.
7. Start four new Phillips head screws and tighten them evenly.
8. If model has pilot inlet and/or outlets, select correct fittings and connect pilot line(s).
9. Reconnect thermocouple.
10. Turn on gas supply and leak test.
11. Extinguish pilot flame and check for proper valve closing and gas shutoff.

CAUTION

THIS DEVICE SHOULD BE INSTALLED BY A QUALIFIED SERVICE TECHNICIAN WITH DUE REGARD FOR SAFETY, AS IMPROPER INSTALLATION COULD RESULT IN A HAZARDOUS CONDITION.





Procedure for Lighting

1. Wait five minutes to allow gas which may have accumulated in the burner compartment to escape.
2. Depress red button and light pilot (Fig. 1, A).
3. Hold red button approximately one-half minute then release. If pilot does not remain lit, repeat operation allowing longer period before releasing reset button. (Adjust pilot if necessary as noted under "Pilot Burner Adjustment.")

Pilot Burner Adjustment
(On models equipped with pilot adjustment key)

NOTE: If cap is sealed adjustment has been made at the factory.

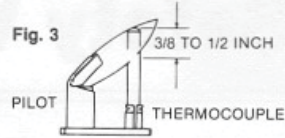

1. Remove Pilot Adjustment Cap (Fig. 1, B).
2. Turn Pilot Key to provide properly sized flame (Fig. 3).
3. Replace Pilot Adjustment Cap.

Replacing Magnet Housing Assembly
See Fig. 4.

1. Close gas supply at line valve or meter.
2. Disconnect thermocouple.
3. Disconnect pilot tubing.
4. Remove four Phillips screws.
5. Remove: A. Magnet Housing Assembly (note thermocouple position).
B. Gasket
C. Valve spring
D. Valve assembly

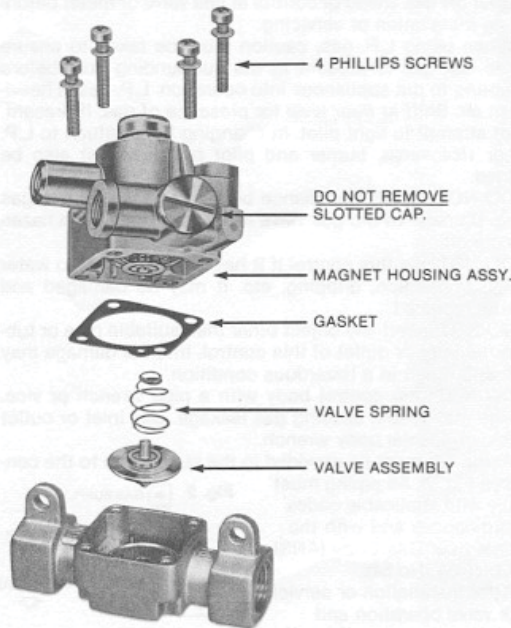
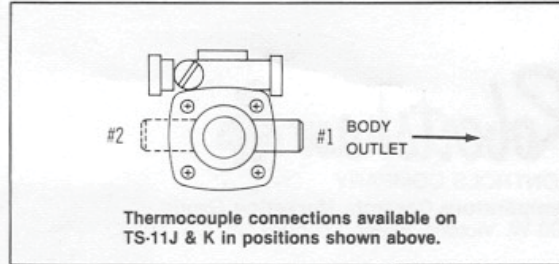

Fig. 4

6. Clean valve seat with soft, lint-free cloth.
7. Install new valve assembly, valve spring, gasket and magnet housing assembly. Make sure valve spring engages magnet stem.
8. Reconnect pilot tubing and thermocouple.
9. Follow Leak Test procedure on page 1, item 10.



Thermocouple connections available on TS-11J & K in positions shown above.

Body Sizes		Capacities (BTU/HR @ 1" W.C.P.D.)	
Inlet	Outlet	Natural Gas	L.P. Gas
1/4" P	1/4" P	102,000	165,000
7/16" C.C.	7/16" C.C.	106,000	171,000
3/8" P	7/16" C.C.	128,660	208,400
3/8" P	3/8" P	138,000	223,000
1/2" P	1/2" P	210,000	340,000

P = Pipe, C.C. = Compression Coupling

Pilot Connections		
Model	Inlet	Outlet
J	1/8" P	1/8" P
J	1/4" C.C.	1/4" C.C.
J	3/16" C.C.	3/16" C.C.
K		1/8" P
K		1/4" C.C.
K		3/16" C.C.

Above available with or without pilot adjustment.

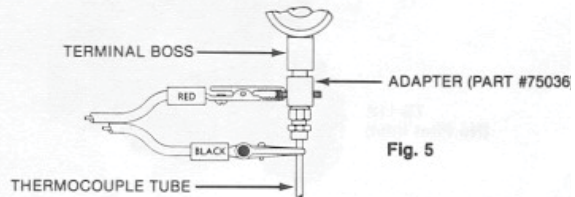

Fig. 5

Troubleshooting

Problem: Pilot will not stay lit.

1. Check for drafts.
2. Check if pilot has sharp blue flame. If not, clean pilot orifice.
3. Pilot flame should heat 3/8" of tip of thermocouple (See Fig. 3). If not, adjust pilot flame (See Pilot Burner Adjustment).
4. Make sure thermocouple is tightened snugly into safety valve. (Finger tight plus 1/4 turn with wrench).
5. Make sure main burner flame is not heating thermocouple.
6. (See Fig. 5). Test magnet and thermocouple as follows:
 - A. Unscrew thermocouple nut from safety valve. Screw adapter (Robertshaw part #75036) into thermocouple opening.
 - B. Screw thermocouple nut into adapter. Connect millivolt meter leads to adapter and thermocouple as shown. Light the pilot. Allow pilot flame to heat thermocouple three minutes. If meter then reads below five millivolts, replace thermocouple. If pilot will not stay lit, hold red button down during this test.
 - C. If pilot remains lit, blow it out and watch millivolt meter. The magnet should continue to hold for a drop of five millivolts or more. A "snap" can be heard when magnet releases. If magnet does not hold for a drop of at least five millivolts, replace entire valve, or magnet housing assembly (Fig. 4). Also, with main burner flame "ON", check to see if millivolt output is affected.



Robertshaw
 CONTROLS COMPANY
 Temperature Controls Marketing Group
 100 W. Victoria Street, Long Beach, CA 90805

INFORMATION BULLETIN

**“TS” - Series
 Thermomagnetic
 Safety Valves**

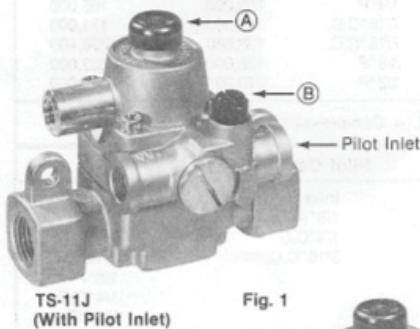

TS-11J
 (With Pilot Inlet)

Fig. 1

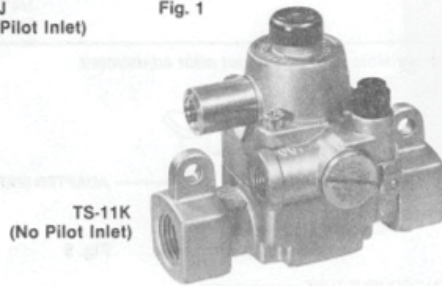

TS-11K
 (No Pilot Inlet)

THE ROBERTSHAW “TS” SERIES THERMOMAGNETIC SAFETY VALVE is a control used to cut off the flow of gas to the burner in the event of pilot outage. The magnet assembly is energized by voltage generated by a thermocouple, that is heated by the pilot flame. When this flame is extinguished, the thermocouple voltage decreases until a spring overcomes the magnetic force and closes off both the pilot and main gas.

This control can be used for commercial and residential ovens, infra-red heaters, chicken and pig brooders, recreational vehicle gas appliances, and many more applications requiring automatic safety.

Installation Instructions

Piping

Make sure piping is clean and free from scale and burrs. Apply a small amount of good quality pipe thread compound suitable for the type gas being used. Thread compound should be used sparingly and on male threads only, leaving the first two threads clean.

Thread compound should never be used on female threads as it may be pushed into the valve body.

Thermocouple

The thermocouple nut should be started and turned all the way in by hand. An additional quarter turn with a small wrench will then be sufficient to seat the lock washer. CAUTION: DO NOT OVERTIGHTEN.



To avoid possible injury, fire and explosion, please read and follow these precautions and all instructions on appliance. This bulletin is intended as a guide to qualified servicemen installing or servicing Robertshaw Controls.

As the manufacturer of the control, we recommend repair and adjustments be limited to the operations listed, which our experience shows are practical service operations.

1. Installation or servicing of gas appliances or controls must be performed by qualified personnel.
2. Shut off gas ahead of control at line valve or meter before starting installation or servicing.
3. When using L.P. gas, caution must be taken to ensure that no raw gas is present in the surrounding area before attempting to put appliances into operation. L.P. gas is heavier than air. Sniff *at floor level* for presence of gas. If present, do not attempt to light pilot. In changing from natural to L.P. gas, or vice versa, burner and pilot orifices must also be changed.
4. DO NOT connect appliance before pressure testing gas piping. Damage to the gas valve may result, causing a hazardous condition.
5. DO NOT use this control if it has been exposed to water through immersion, dripping, etc. It may be damaged and must be replaced.
6. DO NOT insert any object other than suitable pipe or tubing in the inlet or outlet of this control. Internal damage may occur and result in a hazardous condition.
7. DO NOT grip control body with a pipe wrench or vice. Damage may result, causing gas leakage. Use inlet or outlet bosses, or special body wrench.
8. A drip leg must be provided in the supply line to the control (see Fig. 2). All piping must comply with applicable codes and ordinances and with the National Fuel Gas Code (ANSI Z223.1/NFPA, No.54).
9. After installation or servicing, check valve operation and automatic pilot valve shut off.
10. Leak test with soap solution after installation or servicing with main burner “on” and “off”. Coat pipe and tubing joints, gaskets etc. with soap solution. Bubbles indicate leaks that must be corrected.
11. DO NOT allow lint or dust to collect in burner area. Keep all combustible materials away from gas appliances.
12. If control fails to turn off, shut off gas at line valve or meter.



RANGE PARTS

ECODECK/YORK REPLACEMENT FIBER CERAMICS

number	fits chamber	interior dimension
225014N	13"	11" (6 lbs.)
225016N	16"	14" (7 lbs.)
225118N	18"	16" (8 lbs.)
225020N	20"	18" (9 lbs.)
225022N	22"	20" (12 lbs.)



CERAMIC INSULATION



REPLACEMENT MASTERRANGE FIRE BRICKS

number	description
225038	13" chamber brick set* (55 lbs.)
225042	16" chamber brick set* (65 lbs.)
225043	18" chamber brick set* (75 lbs.)
225044	20" chamber brick set* (85 lbs.)
225045	22" chamber brick set* (95 lbs.)

*please advise if chamber has a flue collar when ordering



FIREBRICK INSULATION

FLUE COLLAR AND RANGE CEMENT

Ranges without chamber rings often deteriorate without insulating cement. Use 10 lbs. of cement to recement a chamber.

number	description
225009	20 lb. can dry cement
225010	100 lb. sack dry cement
225100	cast iron flue collar (15 lbs.)



DRY CEMENT (20 LB. CAN)



CAST IRON FLUE COLLAR

RANGE DRIP PANS

number	description
227113	galvanized drip pan 13" x 29 1/4" (10 lbs.)
227114	galvanized drip pan 13" x 34" (12 lbs.)
227116	galvanized drip pan 16 1/4" x 29 1/4" (12 lbs.)
227117	galvanized drip pan 16 1/4" x 34" (14 lbs.)
227120	galvanized drip pan 19 1/4" x 29 1/4" (15 lbs.)
227121	galvanized drip pan 19 1/4" x 34" (17 lbs.)
227122	custom galvanized to customer's sketch
227213	stainless drip pan 13" x 29 1/4" (10 lbs.)
227214	stainless steel drip pan 13" x 34" (12 lbs.)
227216	stainless drip pan 16 1/4" x 29 1/4" (12 lbs.)
227217	stainless steel drip pan 16 1/4" x 34" (14 lbs.)
227220	stainless drip pan 19 1/4" x 29 1/4" (15 lbs.)
227221	stainless steel drip pan 19 1/4" x 34" (17 lbs.)
227222	custom stainless to customer's sketch
229821	small sink frame
229822	insert for small sink frame
229934	large sink frame
229935	insert for large sink frame

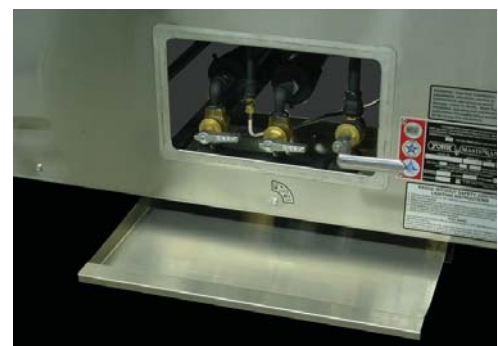

DRIP PAN



SMALL SINK FRAME/INSERT FOR SMALL SINK FRAME

BURNERS AND PARTS

PILOT INCLUDED WITH BURNER. BELOW BURNERS ARE 1/2" NPT INLET.



226916 16 TIP VOLCANO



226920 ANGLE SHIELD TIP



226911 VERTICAL SHIELD TIP



226800 23 TIP JET BURNER



226804 32 TIP JET BURNER

226917



226916B

226808H 226808-60

226916 CLEANING KIT

16 TIP VOLCANO BURNERS

number	description
226916N	16 tip volcano, natural (12 lbs.)
226916P	16 tip volcano, propane (12 lbs.)
226917	replacement tip, natural gas
226918	replacement tip, propane gas
226916C	replacement cover (4 lbs.)
226916N-CLNR	natural gas cleaning kit
226916P-CLNR	propane gas cleaning kit
226916B	cleaning brush
226808H	handle for tip cleaning drill
226808-60	tip cleaning drill, natural gas
226808-73	tip cleaning drill, propane gas

SHIELD TIP BURNERS

number	description
226911N	18 tip vertical shield, natural (10 lbs.)
226911P	18 tip vertical shield, propane (10 lbs.)
226920N	18 tip angle shield, natural (18 lbs.)
226920P	18 tip angle shield, propane (18 lbs.)
226912	shield tip, natural gas
226914	shield tip, propane gas
226808-57	shield tip cleaning drill, natural
226808-72	shield tip cleaning drill, propane
226940	shielded tip wrench

23 AND 32 TIP JET BURNERS

number	description
226800N	23 tip jet burner w/pilot, nat. (9 lbs.)
226800P	23 tip jet burner w/pilot, prop. (9 lbs.)
226804N	32 tip jet burner w/pilot, nat. (13 lbs.)
226804P	32 tip jet burner w/pilot, prop. (13 lbs.)
226806N	jet tip, natural, 1/8" IPS, s/n 58071 & above
226807P	jet tip, propane, 1/8" IPS, s/n 58071 & above
226806	jet tip, natural, old type, small thread
226807	jet tip, propane, old type, small thread
226811	jet pilot, natural
226810	jet pilot, propane
226822	1/8" IPS x 3/8" compression elbow
226808-60	jet tip cleaning drill, natural
226808-72	jet tip cleaning drill, propane
226800B	jet tip cleaning brush

226800B



226808-60



226806



226807P



226811



226822



BURNERS AND PARTS



AIR MIXER PARTS FOR TWO AND THREE RING BURNERS

number	description
226110	air mixer assembly, natural
226111	air mixer assembly, propane
226117	air mixer orifice, natural
226119	air mixer orifice, propane
226115	air mixer set screw
226609	3/8" air mixer nipple
226526	3/8" air mixer street elbow



RING BURNERS

number	description
226130	2 ring burner/nipple for range (14 lbs.)
226131	3 ring burner/nipples for range (30 lbs.)
226130-18	2 ring burner/nipple for SR-18 (14 lbs.)
226131-24	3 ring burner/nipples for SR-24 (30 lbs.)

SAFETY PILOT PARTS FOR RANGES

number	description
249002	1/2" IPS safety, pilot out only, TS11K
249011	3/8" IPS safety, pilot out only, TS11K
252238	36" thermocouple
226203B	universal pilot bracket, s/n 58071 & above



1/2" IPS SAFETY
249002



3/8" IPS SAFETY
249011

36" THERMOCOUPLE
249006



9 AND 12 TIP ANTI-CLOG VOLCANO BURNERS

Available on new ranges only. Not sold separately.

number	description
226950N	9 tip no-clog, natural (25 lbs.)
226950P	9 tip no-clog, propane (25 lbs.)
226960N	12 tip no-clog, natural (25 lbs.)
226960P	12 tip no-clog, propane (25 lbs.)
226952	replacement tip, natural
226953	replacement tip, propane
226950C	no-clog burner cover (10 lbs.)
226808-56	tip cleaner, natural
226808-70	tip cleaning drill, propane, 9 tip
226808-71	tip cleaning drill, propane, 12 tip



NO-CLOG BURNER WITH COVER
226960



REPLACEMENT PARTS



AutoFlo™...the Original Swing Faucet Beware of imitations! One piece cast brass body and heat proof internal parts let our faucet outlast all others. Look for "AutoFlo" stamped on the faucet.

number	description
228800	___ 3/8" swing faucet, 11 1/2"
228900	___ 3/8" swing faucet, 14"
228811	___ A aerator
228813	___ B water switch
228812	___ C "O" rings (union washer)
228815	___ D rubber "O" ring for threaded inlet
228814	___ E spring washer
228817	___ F screw
228820	___ repair kit-contains: (1) water switch, (1) spring washer, and (2) "O" rings (union washers)

PILOT BURNERS AND PARTS

number	description
226202N	___ anti-clog pilot, natural gas
226203P	___ anti-clog pilot, propane gas
226202NT	___ anti-clog ring burner pilot, natural gas
226203PT	___ anti-clog ring burner pilot, propane gas
226824	___ 1/8" IPS x 1/4" compression coupling
226204	___ anti-clog pilot orifice, natural gas
226205	___ anti-clog pilot orifice, propane gas
226203B	___ universal pilot bracket, for s/n 58071 and above

GAS VALVES

number	description
226102F	___ 3/8" x 3/8" F gas valve (short handle)
226104F-2	___ 3/8" x 3/8" F gas valve (long handle)
226104M	___ 1/2" x 1/2" M gas valve (older ranges)
226103	___ short handle for 3/8" valve
226105	___ long handle for 1/2" and 3/8" gas valve
226224	___ 24" x 1/4" s/s compression pilot tubing
226201	___ 1/4" compression x 1/8" IPS pilot valve

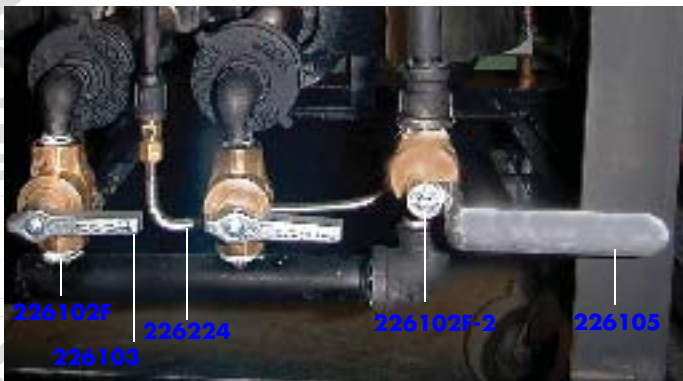

FOOD SERVICE EQUIPMENT CO., INC.

富田食品株式会社

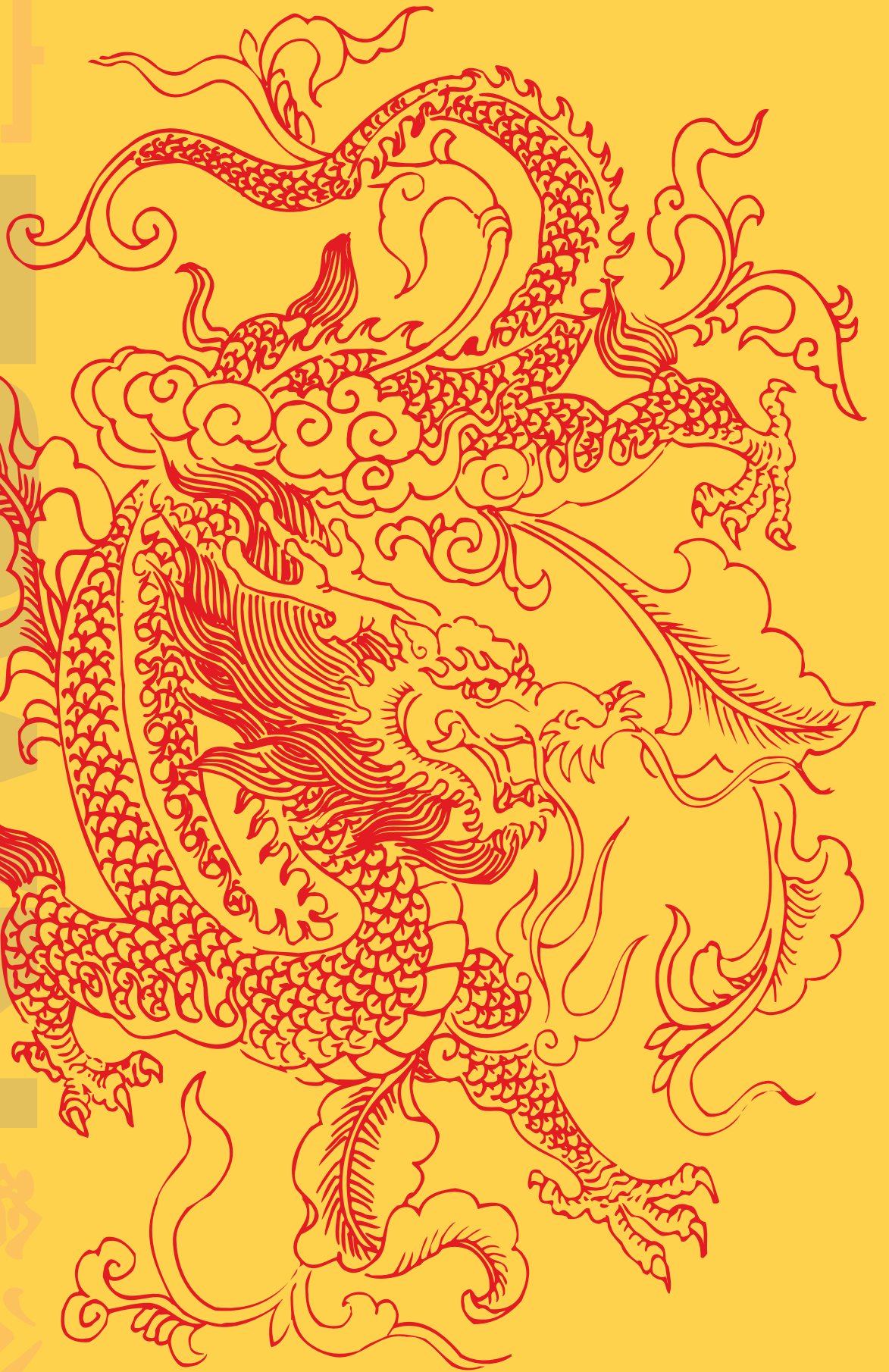



LIMITED WARRANTY

Town warrants all Smokehouses free from defects of workmanship or material for one (1) year from invoice date with the exception of safety pilot systems which are covered by a 90 day warranty. Safety pilot systems installed without drip legs are not covered by this warranty. Defective parts returned prepaid will be repaired or replaced subject to our inspection and returned freight collect. Mishandling or abuse of equipment or components is not covered by this warranty and repairs or replacement will be made at a nominal charge. Labor costs to return or replace parts in this equipment are the responsibility of the purchaser, as are proper installation and adjustments.

RECORD OF OWNERSHIP

FOR YOUR RECORDS PLEASE RECORD THE FOLLOWING INFORMATION OF YOUR WOK RANGE

MODEL NUMBER _____ SERIAL NUMBER _____ DATE OF PURCHASE _____

DEALER _____ DEALER'S PHONE NUMBER _____



TOWN

豐公司
發富

FOOD SERVICE EQUIPMENT CO., INC.
72 BEADEL STREET BROOKLYN, NY 11222



800/221.5032
718/388.5650



718/388.5860



customerservice@townfood.com



www.townfood.com