

**DO NOT DISCARD INSTRUCTIONS. THIS MANUAL MUST REMAIN WITH THE UNIT FOR FUTURE REFERENCE.
THIS EMERGENCY INFORMATION MUST BE PROMINENTLY DISPLAYED.**



TOWN



FOOD SERVICE EQUIPMENT CO., INC.
72 BEADEL STREET BROOKLYN, NY 11222

800/221.5032 718/388.5650 718/388.5860 customerservice@townfood.com www.townfood.com



MONGOLIAN BARBECUE RANGES

MBR-48 | MBR-48C | MBR-60 | MBR-60C | MBR-72 | MBR-72C | MBR-84 | MBR-84C

SECTION 1 INSTALLATION INSTRUCTIONS

FOR COMMERCIAL USE ONLY

Warning

Improper installation, adjustment, alteration, service or maintenance can cause property damage, injury or death. Read the installation, operating and maintenance instructions thoroughly before installing or servicing this equipment.

For your safety

Do not store or use gasoline or other flammable vapors and liquids in the vicinity of this or any other appliance.

Note

Obtain emergency procedures from your local gas supplier if you smell gas near this equipment.

This emergency information must be prominently displayed



Congratulations on your purchase of a Mongolian Barbecue. It will give you many years of trouble free use if it is properly used and maintained. You can now produce delicious, juicy barbecue quickly and easily. Feel free to call our customer service department at (718) 388-5650 if you have questions regarding equipment operation or care.

FOLLOW THESE INSTRUCTIONS CAREFULLY
Installation area must be free and clear from combustibles.

Your new Mongolian Barbecue Range has been carefully engineered and constructed with the best possible workmanship and materials to provide many years of service. Proper installation is vital for optimal appearance and performance.

**INSTALLATION INSTRUCTIONS FOR MONGOLIAN BBQ RANGE MODELS:
MBR-48, MBR-48-C, MBR-60, MBR-60-C, MBR-72, MBR-72-C, MBR-84, MBR-84-C**

PLANNING AND SITE PREPARATION

PLANNING THE INSTALLATION OF YOUR MBR IS IMPORTANT

UNCRATING AND PREPARING MBR UNITS FOR INSTALLATION

We recommend a licensed rigger be used to set up this equipment. It has been shipped in two crates:

- **CRATE A** MAIN COOKING UNIT
- **CRATE B** ROUND COOK TOP

The bottom of the main unit has a set of parallel rails designed to be engaged by a pallet jack or a forklift. The main unit with the top mounted weighs approximately 1500-2100 pounds. We do not recommend moving the unit after the top has been mounted. Use a lifting device rated in excess of that amount to lift the load. OSHA standards for equipment handling must be adhered to. Be sure that the fork rails are properly mated with the jack and/or the forks or serious damage and/or injury may result when the unit is lifted.

- 1 Uncrate the main unit and the top.
- 2 Place the main unit in the position it will occupy. Be sure to locate your unit with the clearances away from combustible construction as indicated on the nameplate of the unit. Remove packing materials. Check gas burners that may have shifted in transit and resecure them if required. Turn all gas valve lever handles to **off** position. Check to ensure that all burner pipe nipples are aligned and fully inserted into air mixers. Tighten air mixer set screws if necessary.
- 3 Clearances for noncombustible construction are the same as combustible clearances. All MBRs are only suitable for installation on noncombustible floors.
- 4 Level the body before the cook top is mounted. Leveling of the top is done using directions that follow after the cook top has been placed on the body and the gas connection has been made.

When the unit is in final operating position confirm that all of the top support lugs are the same height AFF. Each bullet leg must touch the floor. **Body must be level in final position before connecting gas.**

MBR-48
MBR-72



800/221.5032
718/388.5650



718/388.5860



customerservice@townfood.com



www.townfood.com

BODY INSTALLATION

- 1 We recommend the use of a 2" gas line to feed the unit. Minimum line size is 1 ½". Large MBR units will not perform as designed if an insufficiently sized gas line is attached.
- 2 The installation must conform with the National Fuel Gas Code, ANSI Z223.1, Natural Gas Installation Code, CAN/CGA-B149.1 or the Propane Installation Code, CAN/CGA-B149.2, as applicable, including:
 - a The appliance and its individual shutoff valve must be disconnected from the gas supply piping system during any pressure testing of that system at test pressures in excess of ½ PSI (3.45 kPa).

This individual shut-off valve is a master valve that shuts off the gas to the entire unit and must be installed to meet code requirements listed above.
 - b The appliance must be isolated from the gas supply piping system by closing its individual manual valve during any pressure testing of the gas supply piping system at test pressures equal or less than ½ PSIG (3.45 kPa).
- 3 Local regulations governing gas appliance installations must be complied with.
- 4 This equipment must be installed underneath a hood to ensure adequate ventilation.
- 5 **MBR-48/84** installation is generally in the center of a cooking area with clear access on all sides.
- 6 Materials such as wood, compressed paper and plant fibers that will ignite and burn, must not be exposed near the range. Local safety codes should be complied with in respect to fire hazard avoidance.
- 7 Use the Town supplied appliance gas pressure regulator with vent limiting device or an approved ANSI/CGA equivalent. The regulator must be installed in a location where it remains cool and is accessible for pressure adjustment (ANSI Z83.11-1996 sect. 1.15.5). **Never mount regulator inside grill body.** (Town supplies an RV-61 1 ¼" NPT.)
 - a. If this unit is installed in a building with a 2 PSI gas system, a first stage "pounds to inches" line regulator must be installed upstream of the appliance regulator. This regulator is to be supplied by the installing company/contractor.
- 8 The unit must be kept clear to avoid restriction of air supply for combustion.
- 9 The unit must be installed in an area or room with sufficient fresh air supply to ensure proper combustion.
- 10 There must be adequate clearance for air openings into the combustion chamber.
- 11 This equipment must be installed with adequate clearance for servicing and proper operation.
- 12 This unit should be operated only with drip pan in place.



800/221.5032
718/388.5650



718/388.5860



customerservice@townfood.com



www.townfood.com

TOP INSTALLATION

- 1 There are leveling screws on the top of the main body. The height of the screws has been adjusted at the factory to ensure proper combustion. Do not change the settings except in order to adjust the leveling of the top.
- 2 Never place any part of your body between the cook top and the main unit. Never place your hands underneath the top or in the gap between cook top and the main unit.
- 3 If you have a model with a scrap chute, we recommend mounting the scrap chute after the top is in position.
- 4 After verifying that the adjusting screws are locked in place, lift the top into position over the main cooking unit by using an ANSI approved sling (fabric or chain) that engages a minimum of 3 places on the outside perimeter of the cook top. If your unit has a scrap chute, use a second ANSI sling to engage the central inner hole of the cook top in three places thereby giving six points of support to the top as it is lifted into place.
- 5 Lower the top slowly so that the leveling screws are all located underneath the top. This alignment must be done manually. Line up the top so that it is equal distance on all sides from the scrap shelf. It is recommended that several persons assist during the set up operation. When the top is in position there will be a gap between the top and the base of the unit. This is normal. It allows airflow for proper combustion.
- 6 Level the cook top. Use two carpenter levels; place them on the top at right angles to each other at opposite ends of the top. Use the adjustment screws to level the top. When top is level move the levels 90° and level again. Move levels as necessary until the entire top is level to the floor. The nominal height from the cooking surface to the scrap ring is 8-9".
- 7 Remove the slings from the cook top.
- 8 As a final check, measure the height from the top of the cooking surface to the floor. The size should measure 37½" (+/- ½").
- 9 All units: place the scrap cups into position.
- 10 Top must be properly seasoned (see page 11).

LIGHTING AND SHUT DOWN INSTRUCTIONS

Always use the following lighting and shutdown instructions below when operating your MBR.

A 5 minute complete shut off period is required before lighting or relighting an MBR. See diagrams on page 5.

- 1 Before allowing gas to flow to the MBR, ensure all MBR gas valves are off by turning each handle clockwise. Check for leaks using soapy water or another suitable leak detector. **Do not use an open flame for testing.**
- 2 Use a gas match to light the burner pilots. See figures 1-4, on page 5. Also refer to pages 12-14 for additional safety pilot valve guidelines from the manufacturer, *Robertshaw*.

FIGURE 1
AIR SHUTTER, PILOT, SAFETY PILOT ASSEMBLY
POSITION LIGHTER ROD WITH LIT MATCH OVER PILOT LIGHT (C)

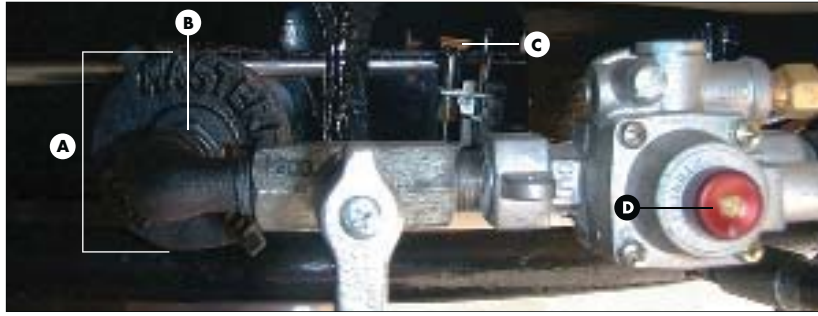

A AIR SHUTTER **B** AIR SHUTTER LOCKING NUT
C PILOT LIGHT (POSITION LIGHTER ROD WITH LIT MATCH) **D** SAFETY PILOT IGNITION BUTTON

3 Burner valves should be in off position (figure 3). An ignition port is provided for each pilot burner. Use a flashlight to locate each prior to inserting a lighting device. Until one is familiar with lighting the unit, it is recommended one person light the pilots and the second to locate and hold the red button on each safety control.

4 Starting at scrap bin access door, insert the ignited lighter through the ignition port and light the pilot burner as you push and hold the red button on the safety control (figure 2).

On initial startup, allow 5 to 15 minutes for air trapped in the gas lines to bleed while holding the safety control ignition button. A qualified gas service technician can bleed the line from the pressure test port. It is located on the manifold to the right of the front access door.

5 The pilot should light. Continue to hold the button for one minute as in figure 2 or until the pilot stays lit. Repeat the above step until all pilots are lit.

6 With all pilots lit, turn each main burner valve counter clockwise to **on** position (figure 3). Be sure all burners are visible through the ports are lit with a clear, blue flame about 2" long. Each burner has an adjustable air mixer that has been preset at the factory but may need to be adjusted depending on altitude and gas composition.

To adjust air/gas mixture, loosen air shutter locking nut. Turn burner valve to full on position as in figure 3. Adjust air shutter until proper blue flame is burning on both rings. Resecure locking nut on air shutter after making adjustments and turn off the burner. All units are equipped with fixed orifices which cannot be adjusted for gas flow.

7 When unit is not in use, turn main burner valves clockwise to off position (figure 3).

8 In the event of power failure, blackout or loss of gas do not attempt to operate the unit.

9 In the event a complete shutdown is required the main service valve must be closed in the off position. The service should be performed only by a qualified gas service mechanic.

FIGURE 2
SAFETY PILOT BUTTON

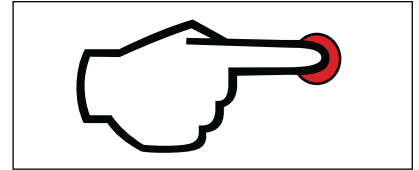

PUT LIT MATCH TO PILOT BURNER, PRESS AND HOLD RED BUTTON ON SAFETY CONTROL

FIGURE 3
BURNER VALVE SHOWN WITH AIR SHUTTER (RING BURNERS ONLY)

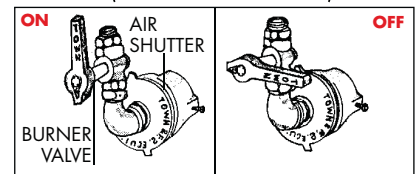

ON POSITION TURN MAIN BURNER VALVE CLOCKWISE TO ON AFTER PILOT IGNITION IS VERIFIED

OFF POSITION TURN MAIN BURNER VALVE COUNTER-CLOCKWISE TO OFF AFTER PILOT IGNITION IS VERIFIED

FIGURE 4 BURNER VALVE HANDLE

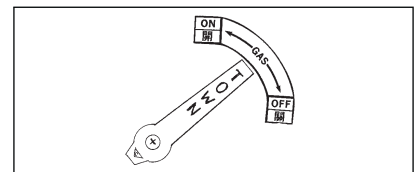

ON TURN COUNTER CLOCKWISE
OFF TURN CLOCKWISE

IMPORTANT

- The natural gas unit is designed for 6" W.C. operational pressure. A minimum of 5½" W.C. must be maintained or performance of the unit will not meet specifications. The propane unit is designed for 10" W.C. operational gas pressure at the outlet. A minimum of 9½" W.C. must be maintained or performance of the unit will not meet specifications.
- There is a 1/8" test tap in the front right section of the manifold behind the access door. Using a manometer or similar device, operating pressure should be verified by a qualified gas mechanic.

OPERATION GUIDE

- 1 The top should come to full operating temperature in approximately 60 minutes after all burners have been lit. Use a high temperature thermometer to verify the cook surface has reached a minimum operating temperature of 500°F.
- 2 When the unit reaches operating temperature turn off every other burner. 14 burners on the MBR-84 on the 12 burner MBR-72 are sufficient to maintain operating temperature except during extremely busy cycles when additional burners may be necessary.

MBR QUICK START GUIDE – LOCAL AUTHORITY CODES APPLY AND MUST BE FOLLOWED

Your MBR will give you optimal service provided it is installed and maintained properly. This is a brief overview of key points that must be observed during the installation and operation of the unit. Please refer to the owner's manual for more detailed information. If you have any general installation or service questions please call Town Food at (718) 388-5650 Monday to Friday, 9^{AM} to 5^{PM}.

INSTALLATION

A licensed plumber familiar with commercial gas kitchen equipment should install this appliance. The following is only an overview. Town assumes no responsibility for improper installation or testing. If you have any problems consult your installer and/or your local gas company. In all cases local authority codes apply and must be followed.

- 1 The supplied regulator must be installed on the outside of the unit, **never install the regulator in the interior tub of your MBR** (figure 1). The supplied vent limiter must be attached to the regulator and not be blocked from venting. A main gas valve to shut off the gas to the unit must be installed before the pressure regulator. A drip leg must be installed at the gas feed. The pilot safety system is sensitive to gas line debris, which is common in new commercial installations. Failure to install the trap will void the warranty on the safety control(s).
- 2 We recommend a 2" gas supply line. Minimum line size is 1½". Large MBR units will not perform as designed if an undersized gas line is used. It will not provide adequate supply volume.
- 3 After installation and leak testing the unit can be lit (see section 2, page 9). With all gas appliances on and all burners of the MBR turned **on**, measure the pressure at the test tap in the MBR. The 1/8" test tap is located on the manifold section above the access doors. Natural gas pressure should be 6" W.C.. If less than 6" W.C. is measured, check to ensure the regulator is properly set. If you cannot obtain a reading of 6" W.C. the unit will not deliver maximum performance. The pressure regulator can be adjusted by removing the brightly finished cap screw located at the top of the regulator revealing a white nylon adjusting screw. Turn this shaft down to increase pressure.

- 4 With all burners ignited, check for proper combustion indicated by a clear blue flame (figure 2). The unit is pre-set at the factory. However, regional gas blends and movement in transit may necessitate on-site adjustment. See page 15 for instructions on how to adjust the air/gas mixture. Check that pilot and thermocouples are properly positioned and have not shifted during shipment of the unit. Tip of thermocouple should be $\frac{3}{8}$ " above the pilot flame. The body of the thermocouple should be engulfed by the pilot flame.
- 5 Follow the instructions on page 11 to season the cooktop before using. This begins the procedure to create a non-stick surface.
- 6 The MBR requires a pre-heat period of up to 60 minutes to achieve operating temperatures. When proper operating temperature is reached, turn off every other burner. Use of all burners during operation will shorten the life span of the thermocouples, safety controls and cook top.



FIGURE 1
A REGULATOR INSTALLED ON THE EXTERIOR OF UNIT



FIGURE 2
A CLEAR BLUE FLAME RESULTING FROM PROPER COMBUSTION

FOOD SERVICE EQUIPMENT CO., INC.

町田食品株式会社

**DO NOT DISCARD INSTRUCTIONS. THIS MANUAL MUST REMAIN WITH THE UNIT FOR FUTURE REFERENCE.
THIS EMERGENCY INFORMATION MUST BE PROMINENTLY DISPLAYED.**



TOWN

豐公司
富司

FOOD SERVICE EQUIPMENT CO., INC.
72 BEADEL STREET BROOKLYN, NY 11222

800/221.5032 718/388.5650 718/388.5860 customerservice@townfood.com www.townfood.com



MONGOLIAN BARBECUE RANGES

MBR-48 | MBR-48C | MBR-60 | MBR-60C | MBR-72 | MBR-72C | MBR-84 | MBR-84C

SECTION 2 OPERATING AND MAINTENANCE INSTRUCTIONS

FOR COMMERCIAL USE ONLY

Warning

Improper installation, adjustment, alteration, service or maintenance can cause property damage, injury or death. Read the installation, operating and maintenance instructions thoroughly before installing or servicing this equipment.

For your safety

Do not store or use gasoline or other flammable vapors and liquids in the vicinity of this or any other appliance.

Note

Obtain emergency procedures from your local gas supplier if you smell gas near this equipment.

This emergency information must be prominently displayed



800/221.5032 718/388.5650 718/388.5860 customerservice@townfood.com www.townfood.com

LIGHTING AND SHUT DOWN INSTRUCTIONS

SEE PAGE 5, FIGURE 1 FOR IMAGE OF AIRSHUTTER, PILOT, SAFETY PILOT ASSEMBLY

Always use the following lighting and shutdown instructions below when operating your [MBR-72/84](#). A 5 minute complete shut off period is required before lighting or relighting an MBR. See figures 1-3 below.

- 1 Before allowing gas to flow to the MBR, ensure all MBR gas valves are off by turning each handle counter clockwise. Check for leaks using soapy water or another suitable leak detector. **Do not use open flame for testing.**
- 2 Use a gas match to light the pilots.
- 3 Burner valves should be in off position (figure 3). An ignition port is provided for each pilot burner. Use a flashlight to locate each prior to inserting the lighting torch. Until one is familiar with lighting the unit, it is recommended one person light the pilots and the second to locate and hold the red button on each safety control.
- 4 Starting at scrap bin access door, insert the ignited match through the ignition port and light the pilot burner as you push and hold the red button on the safety control (figure 1).

On initial start-up, allow 5 to 15 minutes for air trapped in the gas lines to bleed while holding the safety control ignition button. A qualified gas service technician can bleed the line from the pressure test port located on the manifold to the left of the access door.

- 5 The pilot should light. Continue to hold the button for one minute as in figure 2 (previous page) or until the pilot stays lit. Repeat the above step until all pilots are lit.
- 6 With all pilots lit, turn each main burner valve counter clockwise to on position (figure 3). Looking through the ports, be sure that all burners are lit with a clear, blue flame about 2" long. Each burner has an adjustable air mixer that has been preset at the factory but may need to be adjusted depending on altitude and gas composition.

To adjust air/gas mixture, loosen air shutter locking nut. Turn burner valve to full on position (figure 2). Adjust air shutter until proper blue flame is burning on both rings. Tighten locking nut on air shutter after making adjustments and turn off the burner.

All units are equipped with fixed orifices which cannot be adjusted for gas flow.

- 7 When unit is not in use, turn main burner valves clockwise to off position (figure 3).

FIGURE 2
SAFETY PILOT BUTTON

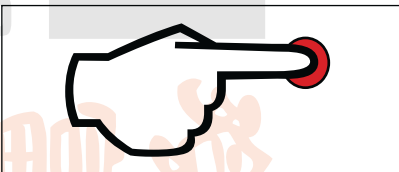

PUT LIT MATCH TO PILOT BURNER,
PRESS AND HOLD RED BUTTON ON
SAFETY CONTROL

FIGURE 2
BURNER VALVE SHOWN WITH AIR SHUTTER (RING BURNERS ONLY)

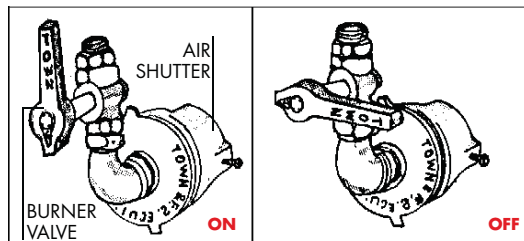

ON POSITION
TURN
COUNTERCLOCK WISE

OFF POSITION
TURN
CLOCKWISE

FIGURE 4 BURNER VALVE HANDLE

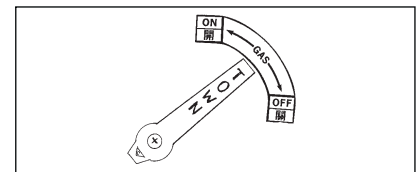

ON TURN COUNTER CLOCKWISE
OFF TURN CLOCKWISE

CONTINUES ON PAGE 10

LIGHTING AND SHUT DOWN INSTRUCTIONS, CONTINUED

- 7 When unit is not in use, turn main burner valves clockwise to off position (figure 3, page 9).
- 8 In the event of power failure, blackout or loss of gas do not attempt to operate this unit.
- 9 In the event of a complete shutdown the main service valve must be closed in the off position. The service should be performed only by a qualified gas service mechanic.

IMPORTANT

- The natural gas unit is designed for 6" W.C. operative pressure. A minimum of 5½" W.C. must be maintained or performance of the unit will not meet specifications. The propane unit is designed for 10" W.C. operational pressure. A minimum of 9½" W.C. must be maintained or performance of the unit will not meet specifications.
- There is a ⅛" test tap in the front right section of the manifold behind the access door. Using a manometer or similar device, adequate pressure should be verified by a qualified gas mechanic after installation and normal operation confirmed.

OPERATING INSTRUCTIONS

- Materials such as wood, compressed paper, and plant fibers that will ignite and burn must not be exposed near this unit. Local safety codes should be complied with in respect to fire avoidance.
- The area around the unit must be kept clear to avoid restriction of air supply for combustion or ventilation for exhaust.
- The equipment must be installed with adequate clearance for air openings into the combustion chamber, servicing and proper operation.
- This appliance is designed and certified for use with either natural or liquid propane gas. Verify gas type is correct and matches the label plate on the unit.
- The installation must conform with the National Fuel Gas Code, ANSI Z223.1, Natural Gas Installation Code, CAN/CGA-B149.1 or the Propane Installation Code, CAN/CGA-B149.2, as applicable, including:
 - a. The appliance and its individual shutoff valve must be disconnected from the gas supply piping system during any pressure testing of that system at test pressures in excess of ½ PSI (3.45 kPa).
 - b. The appliance must be isolated from the gas supply piping system by closing its individual manual valve during any pressure testing of the gas supply piping system at test pressures equal or less than ½ PSIG (3.45 kPa).
- The gas supply line must be of adequate size to ensure maximum efficiency of the unit and conform with the National Fuel Gas Code, ANSI-Z223.1.
- Provisions must be made to assure adequate supply of fresh air to this unit. This unit cannot operate safely without sufficient air supply.
- MBR installation is generally in a clear area as this unit is specifically designed for demonstration cooking. It is suitable for installation only on noncombustible floors that will tolerate very high temperatures.

CONTINUED ON PAGE 11



800/221.5032
718/388.5650



718/388.5860



customerservice@townfood.com



www.townfood.com

OPERATING INSTRUCTIONS, CONTINUED

- MBRs must be operated under a hood to ensure adequate ventilation.
- MBR should be operated only with bottom grease pans and scrap collector bin ("C" models only) in place.
- **Do not throw away this instruction booklet.** This manual must remain with the unit for future reference.

OPERATION GUIDE

- The top should come to full operating temperature in approximately 60 minutes after all burners have been lit. Use a high temperature thermometer to verify that the cook surface has reached a minimum operating temperature of 500°F.
- On reaching operating temperature turn off every other burner. 7 burners on the MBR-84 and 6 on the [MBR-72](#) are sufficient to maintain operating temperature except during extremely heavy cycles when additional burners may be necessary.

OPERATIONAL OVERVIEW

MBRs are high performance griddle-style units. Multiple burners are equally spaced under the top with individual valves and safety controls. Depending on the size of the top up to four chefs can cook simultaneously as they sauté vegetables, fish, meat and poultry as guests watch. MBRs are similar to a tepanyaki griddle but much more powerful.

SEASONING

The first time you use the unit the top must be seasoned. This must be done while the ventilation system is in operation. Wash the top with soapy water to remove all grease and oil from the manufacturing process. Rinse the top immediately. Using the procedure described earlier, fire up the unit and get the top hot.

Turn down the heat and wipe the surface with a towel coated with cooking oil. With repeated heating and wiping, the top will attain a nonstick finish. Do not use soap again to clean the top but rather a griddle scraper to keep the top free from carbon build-ups.

COOKING

This unit is similar to a high-speed griddle. Intense heat generated by the burners heats the top to achieve the searing temperatures of wok-style cooking. Techniques similar to stir-fry are used.

MBRs are designed for use with implements such as our MBR Swords and MBR Veggie Sticks. Like a wok or cast iron fry pan, the top must be re-seasoned periodically. Food should not be allowed to remain on the top as this will cause the top to pit or otherwise deteriorate.

CAUTION: DO NOT CRASH THE TEMPERATURE OF THE TOP. POURING COLD WATER ON THE TOP WHILE STILL HOT, COULD CAUSE THE CAST IRON TO CRACK.

MBRs have manual valves and is not thermostatically controlled. Do not allow all burners to operate at full capacity after the top has reached operating temperature. Half of the burners on, in a staggered arrangement, should provide satisfactory surface temperature of 500°F.

Robertshaw



1720 (TS)

ELECTROMAGNET REPLACEMENT KIT TS AUTOMATIC SAFETY VALVES FOR MODEL 1710 BODY TYPES #9, 10, 11 AND 12 ONLY

1. Turn off all gas supply to equipment being serviced.
2. Disconnect thermocouple. Note location and direction of thermocouple connection.
3. Disconnect pilot gas tubing on models with a pilot inlet and/or outlet.
4. Remove the four Phillips head screws that attach magnet head to valve body. Discard these screws.
5. Remove and discard the following:
 - A. Magnet head assembly
 - B. Diaphragm (Note: Not all models have this thin metal piece.)
 - C. All gaskets
 - D. Main valve — Also discard valve spring on flow interruption models.
6. Install new kit parts as follows:
 - A. Valve and spring assembly, with large end of spring against top of valve.
 - B. Gasket — position gasket to align with mounting surface on valve body.
 - C. Replacement Magnet Head, with thermocouple connection matching location on old head. **NOTE:** Be certain valve spring contacts bottom of magnet stem.
7. Start four new Phillips head screws and tighten them evenly.
8. If model has pilot inlet and/or outlets, select correct fittings and connect pilot line(s).
9. Reconnect thermocouple.
10. Turn on gas supply and leak test.
11. Extinguish pilot flame and check for proper valve closing and gas shutoff.

CAUTION

THIS DEVICE SHOULD BE INSTALLED BY A QUALIFIED SERVICE TECHNICIAN WITH DUE REGARD FOR SAFETY, AS IMPROPER INSTALLATION COULD RESULT IN A HAZARDOUS CONDITION.



800/221.5032
718/388.5650



718/388.5860



customerservice@townfood.com



www.townfood.com



Procedure for Lighting

1. Wait five minutes to allow gas which may have accumulated in the burner compartment to escape.
2. Depress red button and light pilot (Fig. 1, A).
3. Hold red button approximately one-half minute then release. If pilot does not remain lit, repeat operation allowing longer period before releasing reset button. (Adjust pilot if necessary as noted under "Pilot Burner Adjustment.")

Pilot Burner Adjustment
(On models equipped with pilot adjustment key)

NOTE: If cap is sealed adjustment has been made at the factory.

1. Remove Pilot Adjustment Cap (Fig. 1, B).
2. Turn Pilot Key to provide properly sized flame (Fig. 3).
3. Replace Pilot Adjustment Cap.

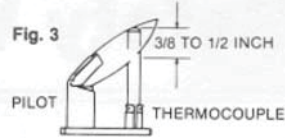

Replacing Magnet Housing Assembly
See Fig. 4.

1. Close gas supply at line valve or meter.
2. Disconnect thermocouple.
3. Disconnect pilot tubing.
4. Remove four Phillips screws.
5. Remove: A. Magnet Housing Assembly (note thermocouple position).
B. Gasket
C. Valve spring
D. Valve assembly

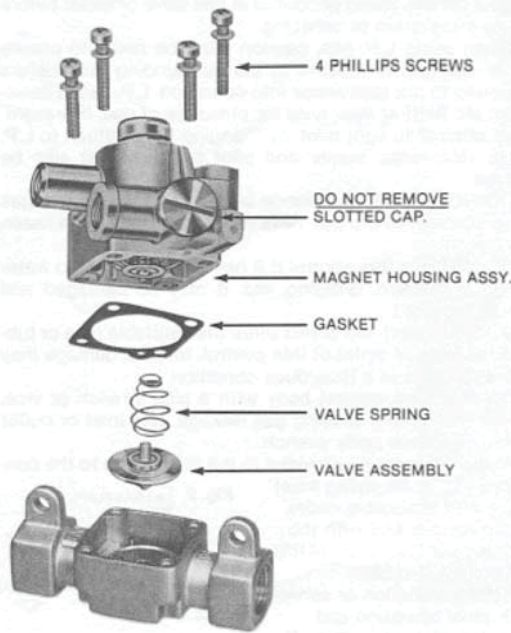
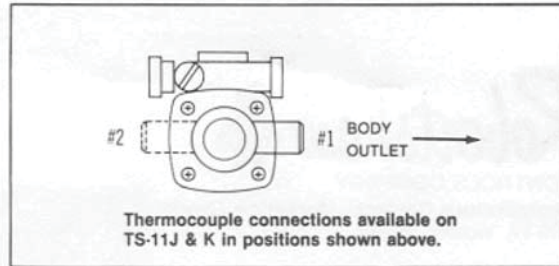

Fig. 4

6. Clean valve seat with soft, lint-free cloth.
7. Install new valve assembly, valve spring, gasket and magnet housing assembly. Make sure valve spring engages magnet stem.
8. Reconnect pilot tubing and thermocouple.
9. Follow Leak Test procedure on page 1, item 10.



Body Sizes		Capacities (BTU/HR @ 1" W.C.P.D.)	
Inlet	Outlet	Natural Gas	L.P. Gas
1/4" P	1/4" P	102,000	165,000
7/16" C.C.	7/16" C.C.	106,000	171,000
3/8" P	7/16" C.C.	128,660	208,400
3/8" P	3/8" P	138,000	223,000
1/2" P	1/2" P	210,000	340,000

P = Pipe, C.C. = Compression Coupling

Pilot Connections		
Model	Inlet	Outlet
J	1/8" P	1/8" P
J	1/4" C.C.	1/4" C.C.
J	3/16" C.C.	3/16" C.C.
K		1/8" P
K		1/4" C.C.
K		3/16" C.C.

Above available with or without pilot adjustment.

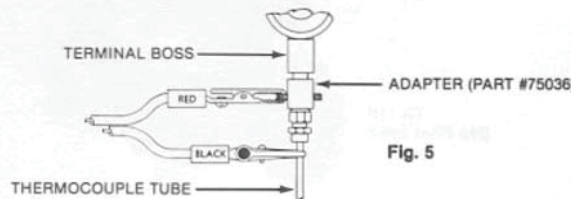

Fig. 5

Troubleshooting

Problem: Pilot will not stay lit.

1. Check for drafts.
2. Check if pilot has sharp blue flame. If not, clean pilot orifice.
3. Pilot flame should heat 3/8" of tip of thermocouple (See Fig. 3). If not, adjust pilot flame (See Pilot Burner Adjustment).
4. Make sure thermocouple is tightened snugly into safety valve. (Finger tight plus 1/4 turn with wrench).
5. Make sure main burner flame is not heating thermocouple.
6. (See Fig. 5). Test magnet and thermocouple as follows:
 - A. Unscrew thermocouple nut from safety valve. Screw adapter (Robertshaw part #75036) into thermocouple opening.
 - B. Screw thermocouple nut into adapter. Connect millivolt meter leads to adapter and thermocouple as shown. Light the pilot. Allow pilot flame to heat thermocouple three minutes. If meter then reads below five millivolts, replace thermocouple. If pilot will not stay lit, hold red button down during this test.
 - C. If pilot remains lit, blow it out and watch millivolt meter. The magnet should continue to hold for a drop of five millivolts or more. A "snap" can be heard when magnet releases. If magnet does not hold for a drop of at least five millivolts, replace entire valve, or magnet housing assembly (Fig. 4). Also, with main burner flame "ON", check to see if millivolt output is affected.



Robertshaw
 CONTROLS COMPANY
 Temperature Controls Marketing Group
 100 W. Victoria Street, Long Beach, CA 90805

INFORMATION BULLETIN

**“TS” - Series
 Thermomagnetic
 Safety Valves**

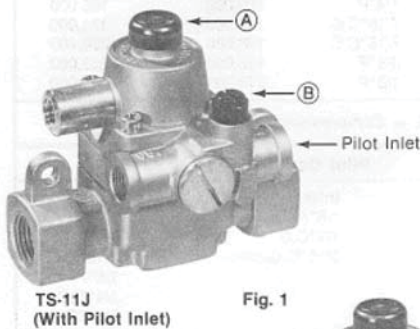

TS-11J
 (With Pilot Inlet)

Fig. 1

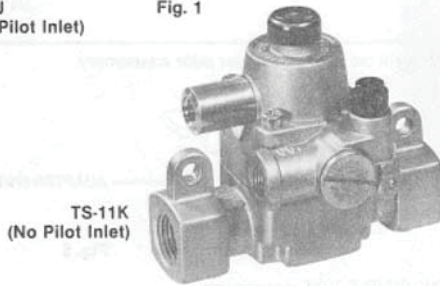

TS-11K
 (No Pilot Inlet)

THE ROBERTSHAW “TS” SERIES THERMOMAGNETIC SAFETY VALVE is a control used to cut off the flow of gas to the burner in the event of pilot outage. The magnet assembly is energized by voltage generated by a thermocouple, that is heated by the pilot flame. When this flame is extinguished, the thermocouple voltage decreases until a spring overcomes the magnetic force and closes off both the pilot and main gas.

This control can be used for commercial and residential ovens, infra-red heaters, chicken and pig brooders, recreational vehicle gas appliances, and many more applications requiring automatic safety.

Installation Instructions

Piping

Make sure piping is clean and free from scale and burrs. Apply a small amount of good quality pipe thread compound suitable for the type gas being used. Thread compound should be used sparingly and on male threads only, leaving the first two threads clean.

Thread compound should never be used on female threads as it may be pushed into the valve body.

Thermocouple

The thermocouple nut should be started and turned all the way in by hand. An additional quarter turn with a small wrench will then be sufficient to seat the lock washer. CAUTION: DO NOT OVERTIGHTEN.



To avoid possible injury, fire and explosion, please read and follow these precautions and all instructions on appliance. This bulletin is intended as a guide to qualified servicemen installing or servicing Robertshaw Controls.

As the manufacturer of the control, we recommend repair and adjustments be limited to the operations listed, which our experience shows are practical service operations.

1. Installation or servicing of gas appliances or controls must be performed by qualified personnel.
2. Shut off gas ahead of control at line valve or meter before starting installation or servicing.
3. When using L.P. gas, caution must be taken to ensure that no raw gas is present in the surrounding area before attempting to put appliances into operation. L.P. gas is heavier than air. Sniff *at floor level* for presence of gas. If present, do not attempt to light pilot. In changing from natural to L.P. gas, or vice versa, burner and pilot orifices must also be changed.
4. DO NOT connect appliance before pressure testing gas piping. Damage to the gas valve may result, causing a hazardous condition.
5. DO NOT use this control if it has been exposed to water through immersion, dripping, etc. It may be damaged and must be replaced.
6. DO NOT insert any object other than suitable pipe or tubing in the inlet or outlet of this control. Internal damage may occur and result in a hazardous condition.
7. DO NOT grip control body with a pipe wrench or vice. Damage may result, causing gas leakage. Use inlet or outlet bosses, or special body wrench.
8. A drip leg must be provided in the supply line to the control (see Fig. 2). All piping must comply with applicable codes and ordinances and with the National Fuel Gas Code (ANSI Z223.1/NFPA, No.54).
9. After installation or servicing, check valve operation and automatic pilot valve shut off.
10. Leak test with soap solution after installation or servicing with main burner “on” and “off”. Coat pipe and tubing joints, gaskets etc. with soap solution. Bubbles indicate leaks that must be corrected.
11. DO NOT allow lint or dust to collect in burner area. Keep all combustible materials away from gas appliances.
12. If control fails to turn off, shut off gas at line valve or meter.

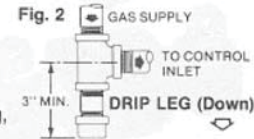

FOOD SERVICE EQUIPMENT CO., INC.

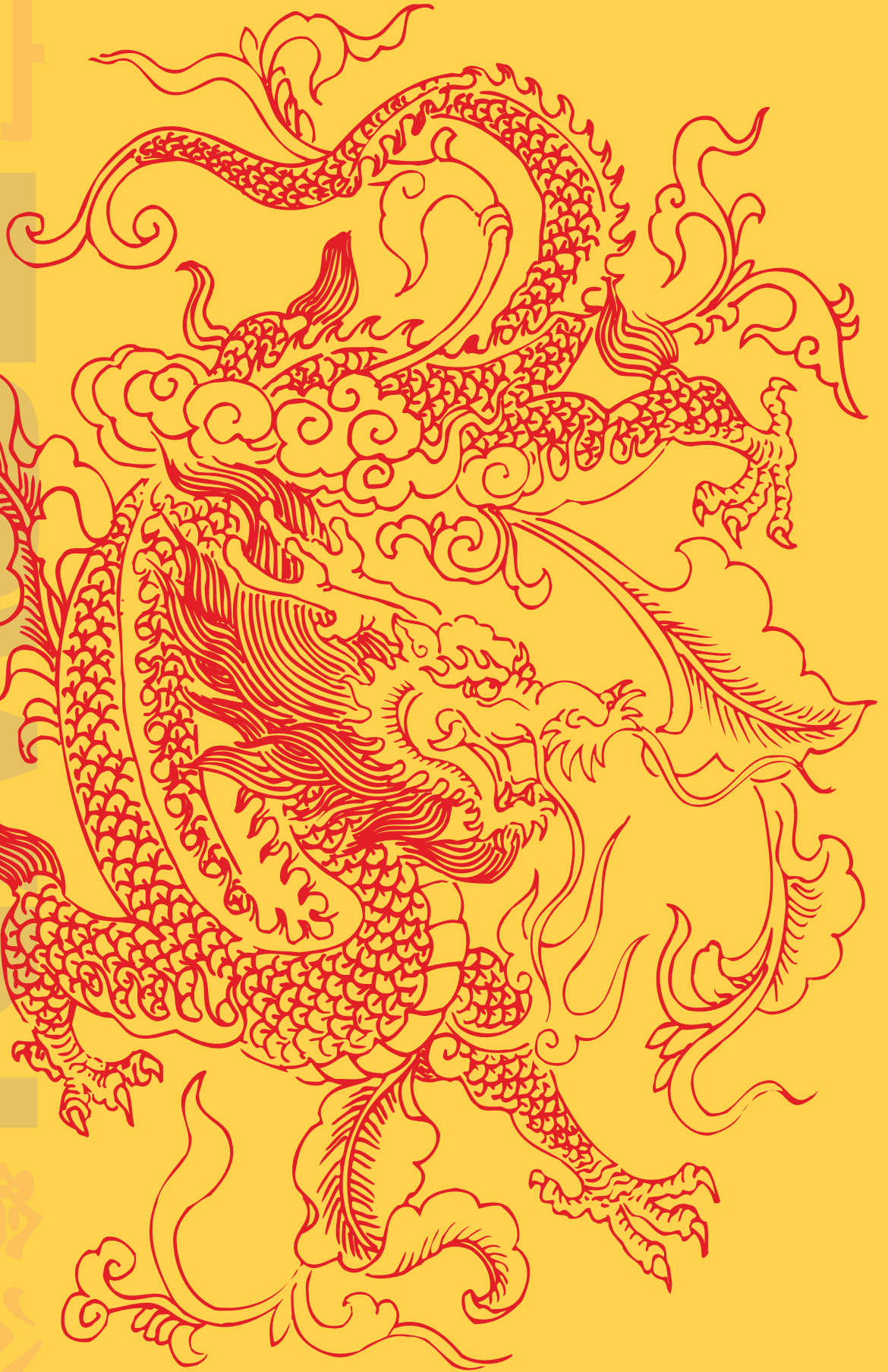



WARRANTY

Town warrants all ranges and smokehouses free from defects of workmanship or material for one (1) year from invoice date with the exception of safety pilot systems which are covered by a 90 day warranty. Safety pilot systems installed without drip legs are not covered by this warranty. Defective parts returned prepaid will be repaired or replaced subject to our inspection and returned freight collect. Mishandling or abuse of equipment or components is not covered by this warranty and repairs or replacement will be made at a nominal charge. Labor costs to return or replace parts in this equipment are the responsibility of the purchaser, as are proper installation and adjustments.

RECORD OF OWNERSHIP

FOR YOUR RECORDS PLEASE RECORD THE FOLLOWING INFORMATION OF YOUR SMOKEHOUSE:

MODEL NUMBER _____ SERIAL NUMBER _____ DATE OF PURCHASE _____

DEALER _____ DEALER'S PHONE NUMBER _____



TOWN

發富公司

FOOD SERVICE EQUIPMENT CO., INC.
72 BEADEL STREET BROOKLYN, NY 11222



800/221.5032
718/388.5650



718/388.5860



customerservice@townfood.com



www.townfood.com