



T&S BRASS AND BRONZE WORKS, INC.

2 Saddleback Cove / P.O. Box 1088
Travelers Rest, SC 29690

Model No.

BL-5705-03

Item No.

Travelers Rest, SC: 800-476-4103 • Simi Valley, CA: 800-423-0150 • Fax: 864-834-3518 • www.tsbrass.com



3 5/16"
[84mm]



ADA Compliant

This Space for Architect/Engineer Approval

Job Name _____ Date _____

Model Specified _____ Quantity _____

Customer/Wholesaler _____

Contractor _____

Architect/Engineer _____

Swivel/Rigid Gooseneck
w/ B-0198 Serrated Tip
w/ Washer Converts to
Rigid w/ 014200-45 Lock
Washer (Included)

Quarter-Turn Eterna
Cartridge w/ Spring
Check & 4-Arm Lab
Handle w/ Color
Coded Index

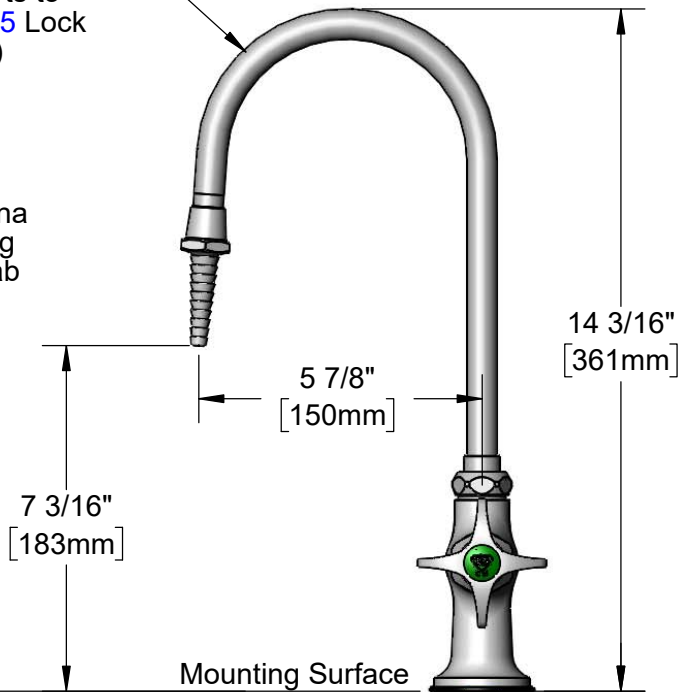
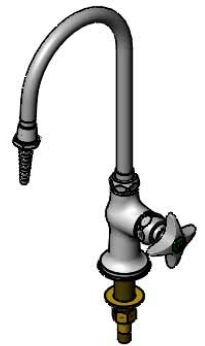

7 3/16"
[183mm]

5 7/8"
[150mm]

14 3/16"
[361mm]

Mounting Surface

2 7/16"
[61mm]

Ø 2" [51mm]
Flange w/
Black Plastic Deck
Gasket & 1/2" NPSM
Male Inlet

1 1/2"
[38mm]
Maximum
Thickness

150A
Optional Tailpiece & Nut
for 1/4" NPT Connection
(Included)

Rough-In Requirement:
Ø 1" [25mm] Mounting Hole

Product Specifications:
Single Hole Single Temperature Laboratory Faucet, Quarter-Turn Eterna
Cartridge w/ Spring Check, 4-Arm Lab Handle, Swivel/Rigid Gooseneck,
Serrated Tip Outlet & 1/2" NPSM Male Inlet

Product Compliance:
ASME A112.18.1 / CSA B125.1
NSF 61 - Section 9
NSF 372 (Low Lead Content)
ANSI A117.1 (ADA)



T&S BRASS AND BRONZE WORKS, INC.

2 Saddleback Cove / P.O. Box 1088
Travelers Rest, SC 29690

Model No.

BL-5705-03

Item No.

Travelers Rest, SC: 800-476-4103 • Simi Valley, CA: 800-423-0150 • Fax: 864-834-3518 • www.tsbrass.com

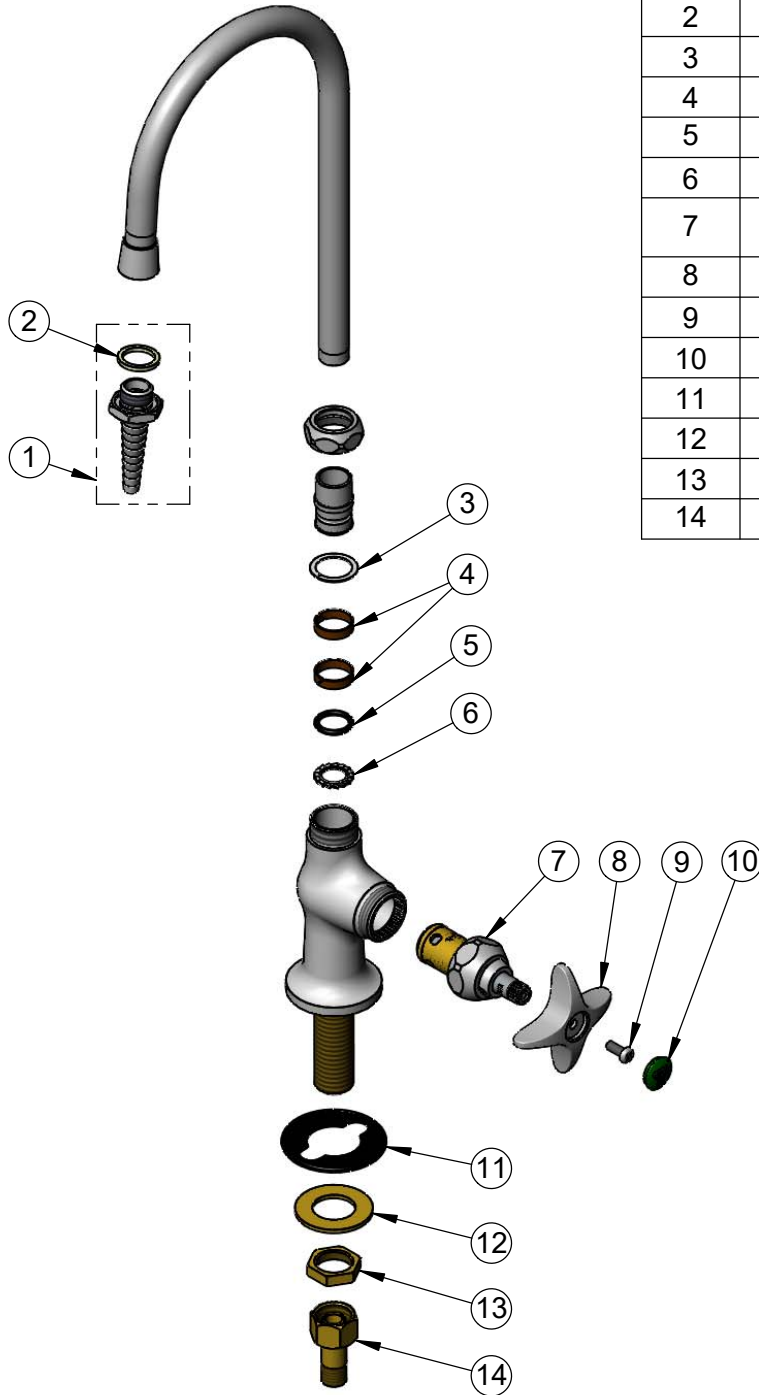

ITEM NO.	SALES NO.	DESCRIPTION
1	B-0198	Serrated Tip w/ Washer
2	001051-45	Washer
3	009538-45	Swivel Washer
4	011429-45	Swivel Sleeves (2)
5	001074-45	O-Ring
6	014200-45	Star Washer, Anti-Rotation
7	012443-40NS	Quarter-Turn Eterna Cartridge w/ Spring Check, RTC
8	002521-45NS	4-Arm Handle (New Style)
9	000925-45	Lab Handle Screw
10	001191-45NS	Green "CW" Lab Button Index
11	144L	Black Plastic Deck Gasket
12	000999-45	Brass Lock Washer
13	002954-45	Shank Lock Nut
14	150A	1/4" NPT Tailpiece & Nut

Product Specifications:

Single Hole Single Temperature Laboratory Faucet, Quarter-Turn Eterna Cartridge w/ Spring Check, 4-Arm Lab Handle, Swivel/Rigid Gooseneck, Serrated Tip Outlet & 1/2" NPSM Male Inlet

Product Compliance:

ASME A112.18.1 / CSA B125.1
NSF 61 - Section 9
NSF 372 (Low Lead Content)
ANSI A117.1 (ADA)