



T&S BRASS AND BRONZE WORKS, INC.

2 Saddleback Cove / P.O. Box 1088
Travelers Rest, SC 29690

Model No.

B-2480

Item No.

Travelers Rest, SC: 800-476-4103 • Simi Valley, CA: 800-423-0150 • Fax: 864-834-3518 • www.tsbrass.com



ADA Compliant

This Space for Architect/Engineer Approval

Job Name _____ Date _____

Model Specified _____ Quantity _____

Customer/Wholesaler _____

Contractor _____

Architect/Engineer _____

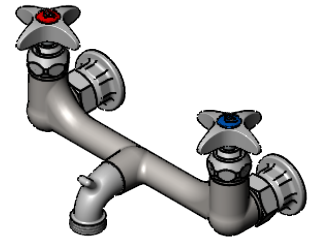
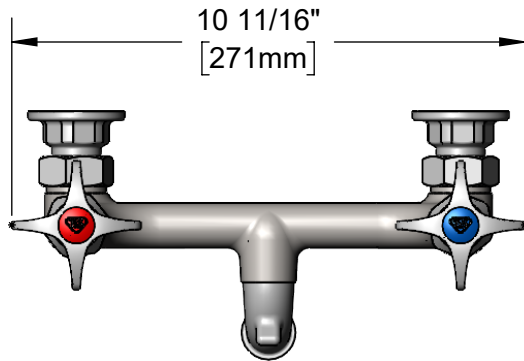

Quarter-Turn Eterna Cartridges w/ Spring Checks & 4-Arm Handles w/ Color Coded Indexes

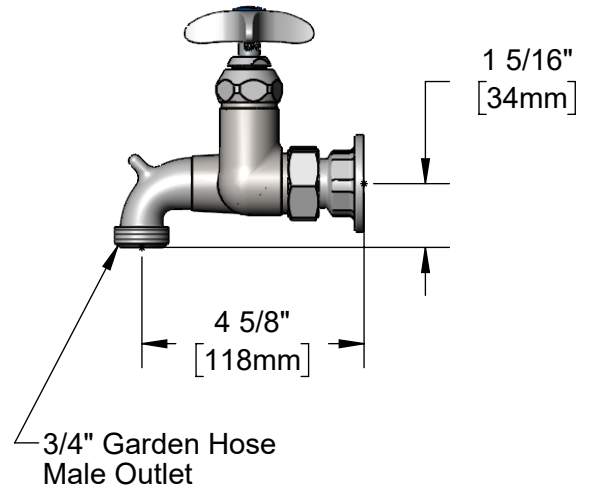
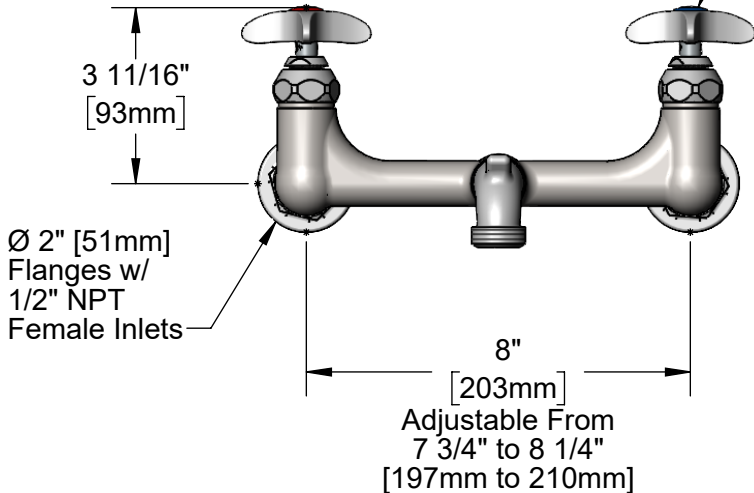

Product Specifications:

8" Wall Mount Rough Chrome Service Sink Mixing Faucet, Quarter-Turn Eterna Cartridges w/ Spring Checks, 4-Arm Handles, 3/4" Garden Hose Male Outlet & 1/2" NPT Female Inlets

Product Compliance:

ASME A112.18.1 / CSA B125.1
NSF 61 - Section 9
NSF 372 (Low Lead Content)
ANSI A117.1 (ADA)



T&S BRASS AND BRONZE WORKS, INC.

2 Saddleback Cove / P.O. Box 1088
Travelers Rest, SC 29690

Model No.

B-2480

Item No.

Travelers Rest, SC: 800-476-4103 • Simi Valley, CA: 800-423-0150 • Fax: 864-834-3518 • www.tsbrass.com

ITEM NO.	SALES NO.	DESCRIPTION
1	000270-25	Short Spout w/ Garden Hose Outlet & Pail Hook
2	012443-40NS	Quarter-Turn Eterna Cartridge w/ Spring Check, LTC
3	002521-45NS	4-Arm Handle (New Style)
4	000925-45	Lab Handle Screw
5	001193-19NS	Red Button Index, Press-in
6	018506-19NS	Blue Button Index, Press-in
7	001019-45	Coupling Nut Washer
8	00AA	1/2" NPT Female Eccentric Flange

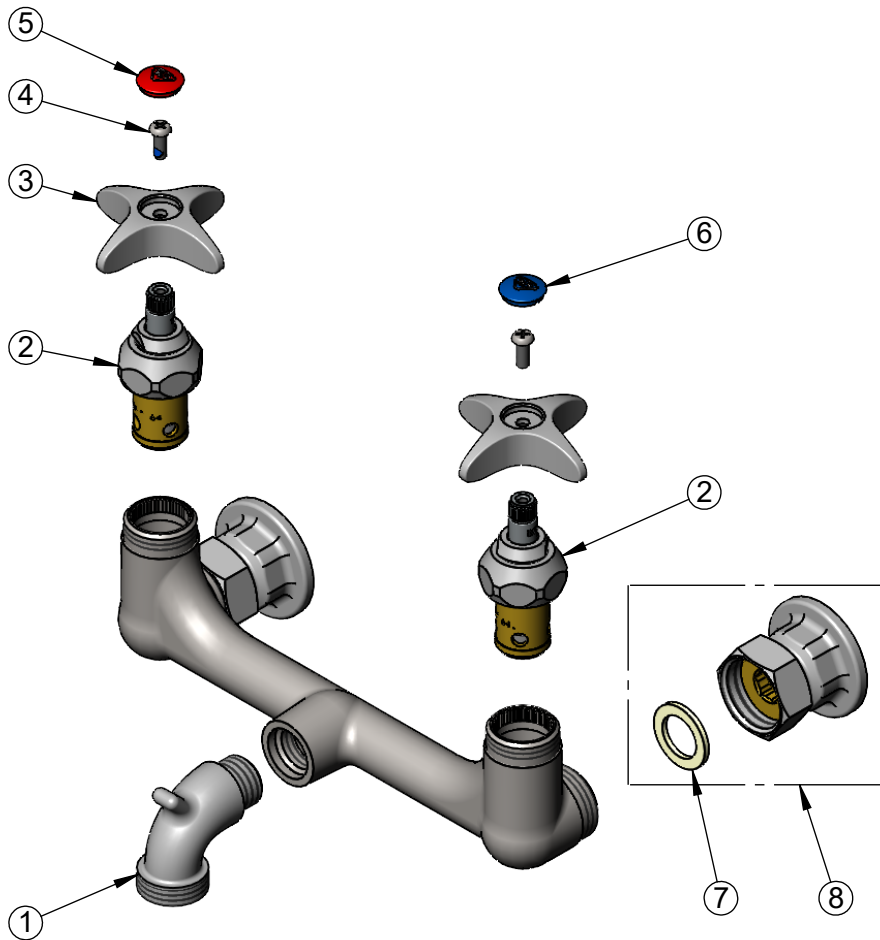

Product Specifications:

8" Wall Mount Rough Chrome Service Sink Mixing Faucet, Quarter-Turn Eterna Cartridges w/ Spring Checks, 4-Arm Handles, 3/4" Garden Hose Male Outlet & 1/2" NPT Female Inlets

Product Compliance:

ASME A112.18.1 / CSA B125.1
NSF 61 - Section 9
NSF 372 (Low Lead Content)
ANSI A117.1 (ADA)