



# T&S BRASS AND BRONZE WORKS, INC.

2 Saddleback Cove / P.O. Box 1088  
Travelers Rest, SC 29690

Model No.

**B-2279-CR**

Item No.

Travelers Rest, SC: 800-476-4103 • Simi Valley, CA: 800-423-0150 • Fax: 864-834-3518 • www.tsbrass.com



Quarter-Turn  
Cerama Cartridges  
w/ Check Valves &  
Lever Handles w/  
Color Coded Indexes



This Space for Architect/Engineer Approval

Job Name \_\_\_\_\_ Date \_\_\_\_\_

Model Specified \_\_\_\_\_ Quantity \_\_\_\_\_

Customer/Wholesaler \_\_\_\_\_

Contractor \_\_\_\_\_

Architect/Engineer \_\_\_\_\_

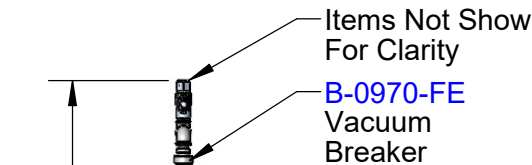

Items Not Show  
For Clarity  
**B-0970-FE**  
Vacuum  
Breaker

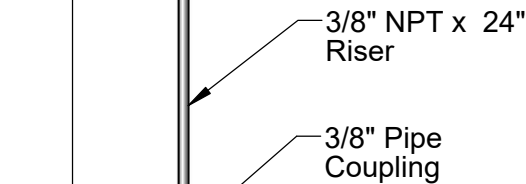

3/8" NPT x 24"  
Riser  
3/8" Pipe  
Coupling



Finger Hook



3/8" NPT x 24"  
Riser

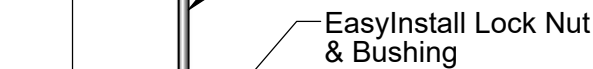

EasyInstall Lock Nut  
& Bushing

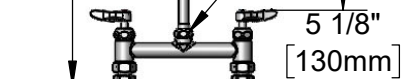

5 1/8"  
[130mm]

Mounting Surface

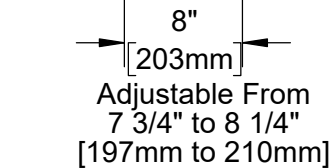

8"  
[203mm]  
Adjustable From  
7 3/4" to 8 1/4"  
[197mm to 210mm]

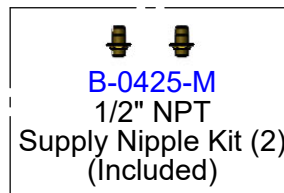

**B-0425-M**  
1/2" NPT  
Supply Nipple Kit (2)  
(Included)

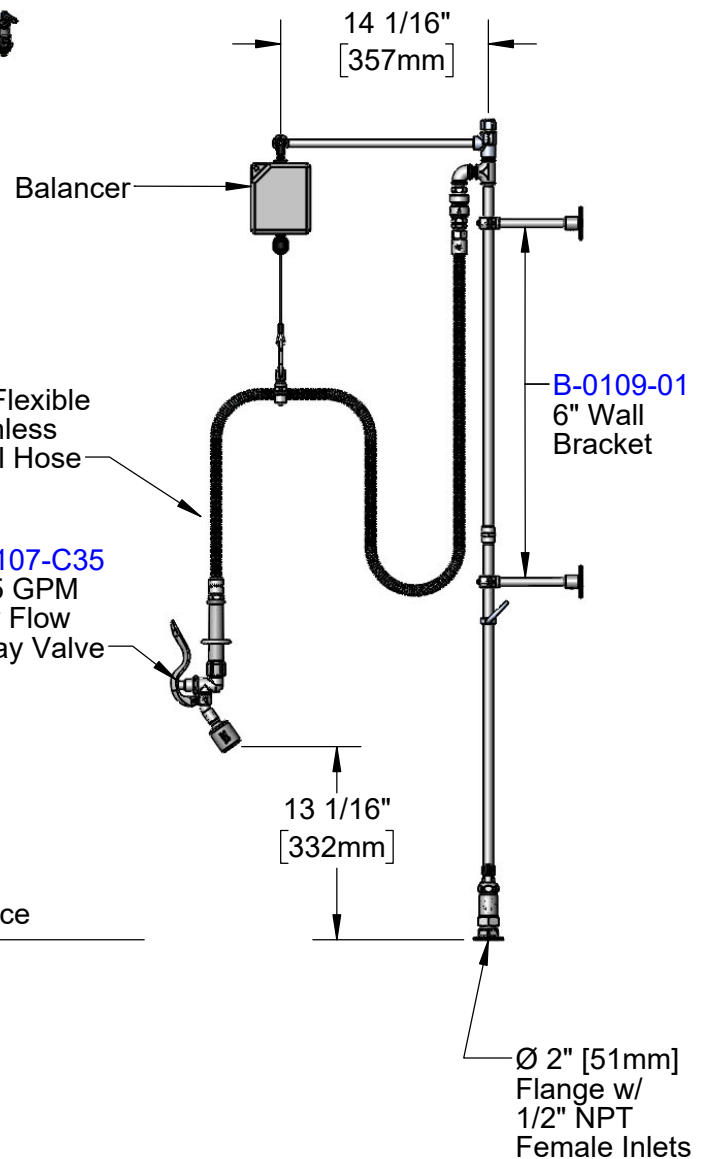

14 1/16"  
[357mm]  
Balancer  
68" Flexible  
Stainless  
Steel Hose  
**B-0107-C35**  
0.65 GPM  
Low Flow  
Spray Valve  
13 1/16"  
[332mm]  
**B-0109-01**  
6" Wall  
Bracket  
Ø 2" [51mm]  
Flange w/  
1/2" NPT  
Female Inlets

**Product Specifications:**

Pre-Rinse Unit: EasyInstall 8" Deck Mount Mixing Faucet, Quarter-Turn Cerama Cartridges w/ Check Valves, Swivel Arm w/ Balancer, Vacuum Breaker, 68" Flexible Stainless Steel Hose, 0.65 GPM Low Flow Angled Spray Valve, 6" Wall Brackets & 1/2" NPT Supply Nipple Inlets

**Product Compliance:**

ASME A112.18.1 / CSA B125.1  
NSF 61 - Section 9  
NSF 372 (Low Lead Content)  
CSA B64.8 (VB)  
2019 DOE PRSV - Class I



# T&S BRASS AND BRONZE WORKS, INC.

2 Saddleback Cove / P.O. Box 1088  
Travelers Rest, SC 29690

Model No.

**B-2279-CR**

Item No.

Travelers Rest, SC: 800-476-4103 • Simi Valley, CA: 800-423-0150 • Fax: 864-834-3518 • www.tsbrass.com

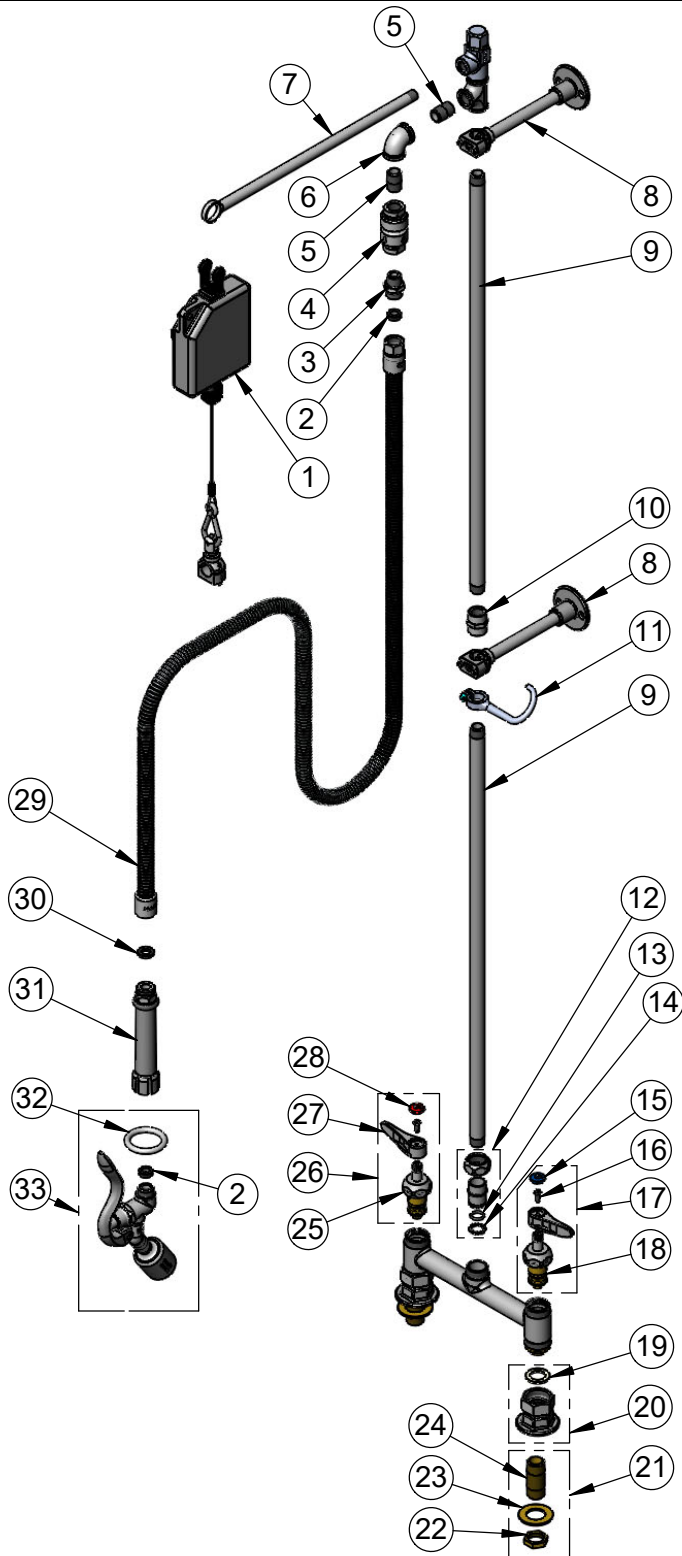

ITEM NO.	SALES NO.	DESCRIPTION
1	005311-40	Balancer
2	010476-45	#27 Washer
3	053A	Adapter, 3/8" NPT Male
4	B-0970-FE	3/8" NPT Vacuum Breaker
5	002535-25	3/8" Close Nipple
6	001355-40	Elbow, 3/8 NPT
7	005252-20	Plated Steel Swivel Arm
8	B-0109-01	6" Wall Bracket
9	000372-40	3/8" NPT x 24" Riser
10	001769-40	3/8" NPT Coupling
11	004R	Finger Hook
12	EZ-K	EasyInstall Kit
13	001065-45	O-Ring
14	014200-45	Star Washer, Anti-Rotation
15	018506-19NS	Blue Button Index, Press-in
16	000925-45	Lab Handle Screw
17	012447-25NS	Quarter-Turn Cerama Cartridge w/ Check Valve, Handle, Blue Index & Screw, LTC
18	012395-25NS	Quarter-Turn Cerama Cartridge w/ Check Valve, LTC
19	001019-45	Coupling Nut Washer
20	00AA	1/2" NPT Female Eccentric Flange
21	B-0425-M	1/2" NPT Supply Nipple Kit (2)
22	002954-45	Shank Lock Nut
23	000999-45	Brass Lock Washer
24	000422-20	1/2" NPT Supply Nipple
25	012394-25NS	Quarter-Turn Cerama Cartridge w/ Check Valve, RTC
26	012446-25NS	Quarter-Turn Cerama Cartridge w/ Check Valve, Handle, Red Index & Screw, RTC
27	001638-45NS	Lever Handle (New Style)
28	001193-19NS	Red Button Index, Press-in
29	B-0068-H2A	68" Flexible Stainless Steel Hose, Less Handle
30	001014-45	Washer, B-0100 Hose Barrel
31	002987-40	Grip Handle
32	000907-45	Spray Valve Hold Down Ring
33	B-0107-C35	0.65 GPM Angled Spray Valve

**Product Specifications:**

Pre-Rinse Unit: EasyInstall 8" Deck Mount Mixing Faucet, Quarter-Turn Cerama Cartridges w/ Check Valves, Swivel Arm w/ Balancer, Vacuum Breaker, 68" Flexible Stainless Steel Hose, 0.65 GPM Low Flow Angled Spray Valve, 6" Wall Brackets & 1/2" NPT Supply Nipple Inlets

**Product Compliance:**

ASME A112.18.1 / CSA B125.1  
NSF 61 - Section 9  
NSF 372 (Low Lead Content)  
CSA B64.8 (VB)  
2019 DOE PRSV - Class I