



T&S BRASS AND BRONZE WORKS, INC.

2 Saddleback Cove / P.O. Box 1088
Travelers Rest, SC 29690

Model No.

B-1355

Item No.

Travelers Rest, SC: 800-476-4103 • Simi Valley, CA: 800-423-0150 • Fax: 864-834-3518 • www.tsbrass.com

This Space for Architect/Engineer Approval

Job Name _____ Date _____

Model Specified _____ Quantity _____

Customer/Wholesaler _____

Contractor _____

Architect/Engineer _____

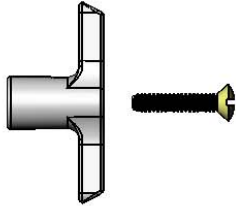

T-Handle Kit w/ Mounting Screw
for Supply Stop

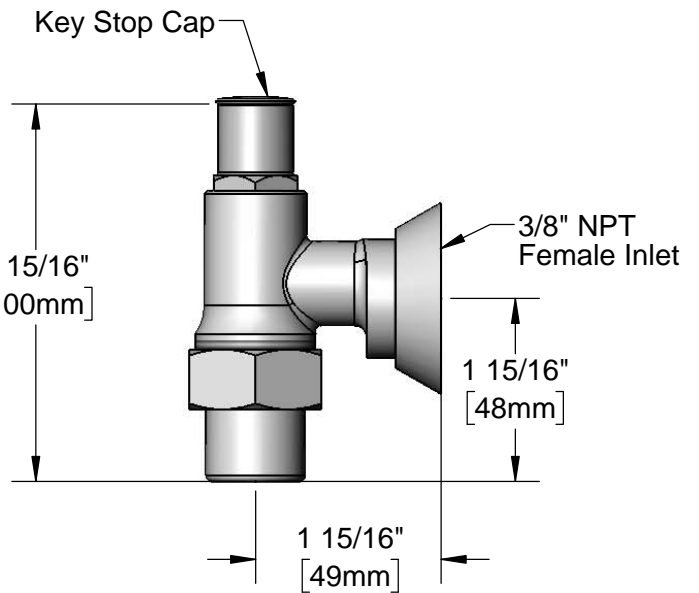
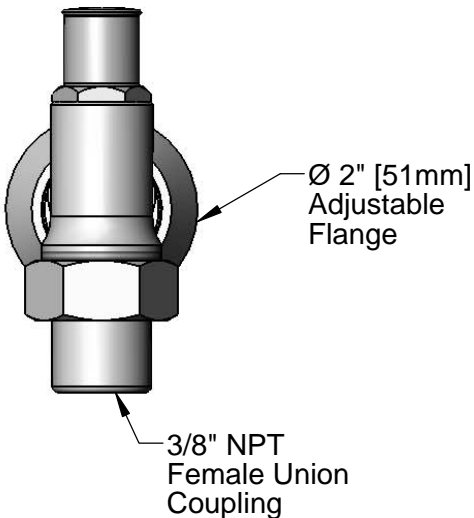
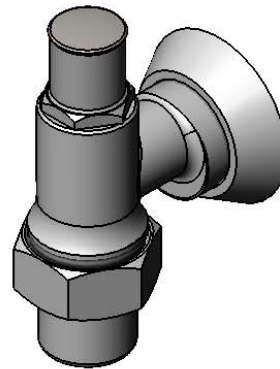

Product Specifications:

Loose Key Angle Stop, Ø2" Adjustable Flange, Loose Key Handle, 3/8" NPT Female Union Coupling Outlet & 3/8" NPT Female Inlet

Product Compliance:

ASME A112.18.1 / CSA B125.1
NSF 61 - Section 9
NSF 372 (Low Lead Content)



T&S BRASS AND BRONZE WORKS, INC.
 2 Saddleback Cove / P.O. Box 1088
 Travelers Rest, SC 29690

Model No.
B-1355

Item No.

Travelers Rest, SC: 800-476-4103 • Simi Valley, CA: 800-423-0150 • Fax: 864-834-3518 • www.tsbrass.com

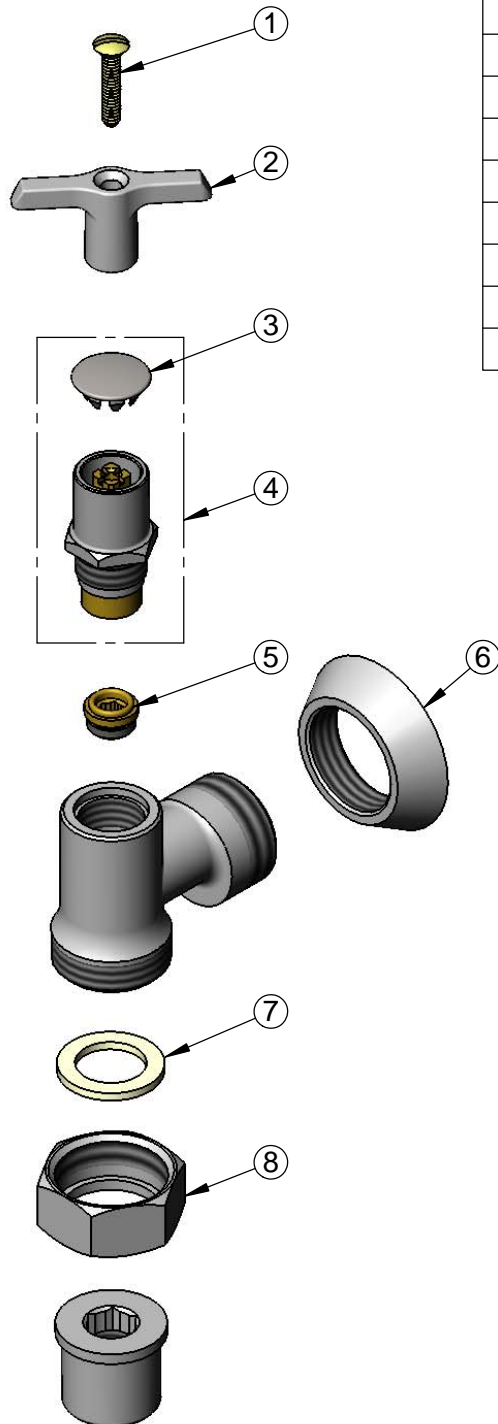

ITEM NO.	SALES NO.	DESCRIPTION
1	002432-45	Screw, Tee Handle
2	001802-45	Handle, Supply Stop "T"
3	001605-45	Cap
4	002892-40	Spindle w/ Cap
5	000763-20	Seat
6	000101-40	Flange
7	001019-45	Coupling Nut Washer
8	000721-25	Flange Coupling Nut

Product Specifications:
 Loose Key Angle Stop, Ø2" Adjustable Flange, Loose Key Handle,
 3/8" NPT Female Union Coupling Outlet & 3/8" NPT Female Inlet

Product Compliance:
 ASME A112.18.1 / CSA B125.1
 NSF 61 - Section 9
 NSF 372 (Low Lead Content)