



# T&S BRASS AND BRONZE WORKS, INC.

2 Saddleback Cove / P.O. Box 1088  
Travelers Rest, SC 29690

Model No.

**B-0968**

Item No.

Travelers Rest, SC: 800-476-4103 • Simi Valley, CA: 800-423-0150 • Fax: 864-834-3518 • www.tsbrass.com

This Space for Architect/Engineer Approval

Job Name \_\_\_\_\_ Date \_\_\_\_\_

Model Specified \_\_\_\_\_ Quantity \_\_\_\_\_

Customer/Wholesaler \_\_\_\_\_

Contractor \_\_\_\_\_

Architect/Engineer \_\_\_\_\_



3/8" NPT Female Outlet

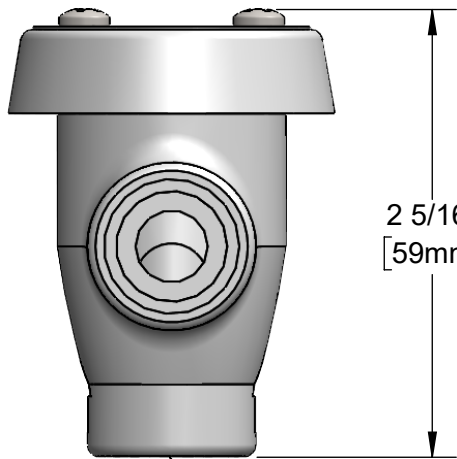

3/8" NPT Female Inlet

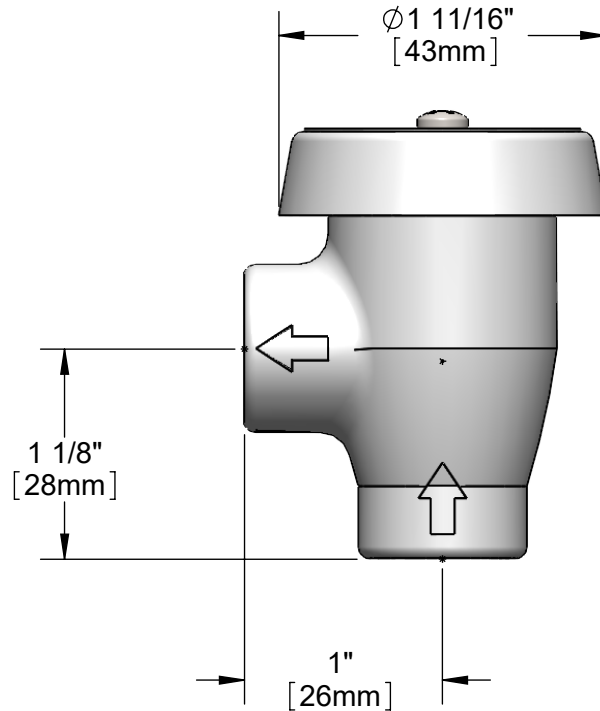

**Product Specifications:**

Atmospheric Vacuum Breaker, Polish Chrome Finish, 3/8" NPT Female Inlet & Outlet

**Product Compliance:**

ASME A112.18.1 / CSA B125.1  
NSF 61 - Section 9  
NSF 372 (Low Lead Content)  
ASSE 1001 (VB)