



**T&S BRASS AND BRONZE WORKS, INC.**  
 2 Saddleback Cove / P.O. Box 1088  
 Travelers Rest, SC 29690

Model No.  
**B-0576**

Item No.

Travelers Rest, SC: 800-476-4103 • Simi Valley, CA: 800-423-0150 • Fax: 864-834-3518 • www.tsbrass.com



**ADA Compliant**

This Space for Architect/Engineer Approval

Job Name \_\_\_\_\_ Date \_\_\_\_\_

Model Specified \_\_\_\_\_ Quantity \_\_\_\_\_

Customer/Wholesaler \_\_\_\_\_

Contractor \_\_\_\_\_

Architect/Engineer \_\_\_\_\_

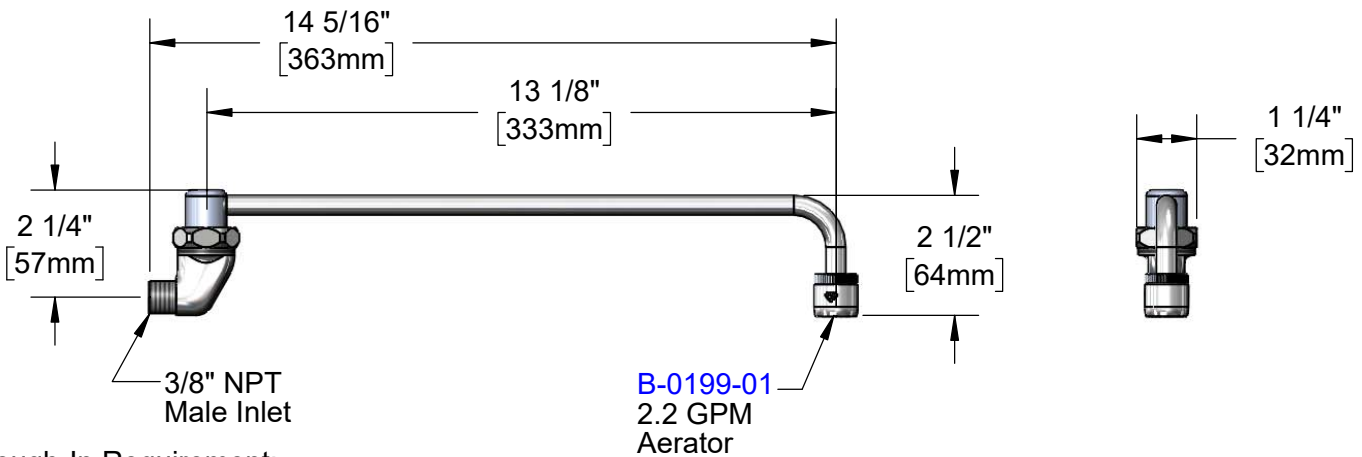
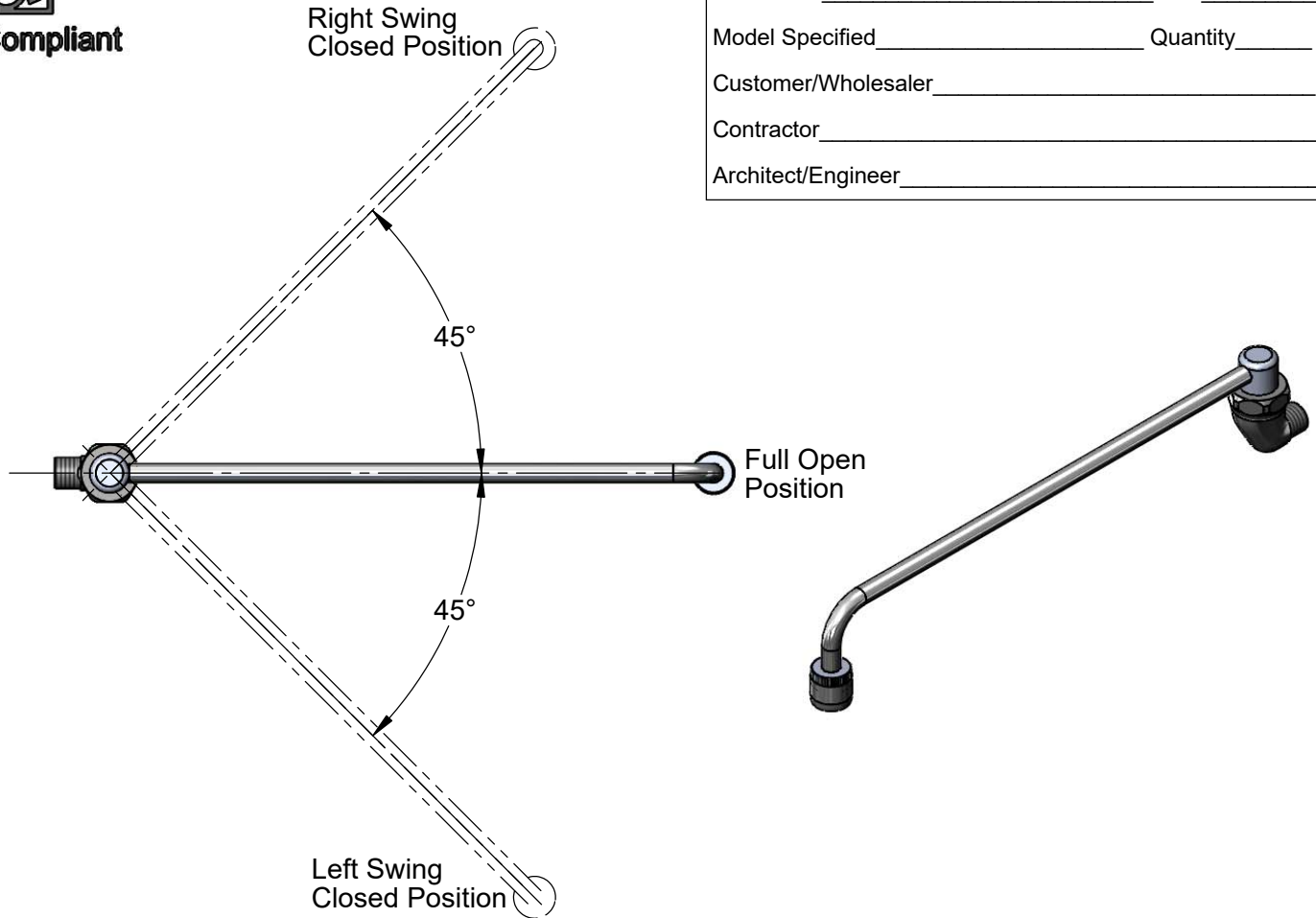

Rough-In Requirement:  
 Ø 1" [25mm] Mounting Hole

Product Specifications:  
 Range Faucet w/ Swing Nozzle, 2.2 GPM Aerator & 3/8" NPT Male Inlet

Product Compliance:  
 ASME A112.18.1 / CSA B125.1  
 NSF 61 - Section 9  
 NSF 372 (Low Lead Content)  
 ANSI A117.1 (ADA)



**T&S BRASS AND BRONZE WORKS, INC.**  
 2 Saddleback Cove / P.O. Box 1088  
 Travelers Rest, SC 29690

Model No.  
**B-0576**

Item No.

Travelers Rest, SC: 800-476-4103 • Simi Valley, CA: 800-423-0150 • Fax: 864-834-3518 • www.tsbrass.com

ITEM NO.	SALES NO.	DESCRIPTION
1	001625-45	Spring
2	009267-45	O-Ring
3	001621-20	Dynamic Bearing
4	009268-45	O-Ring
5	006562-45	O-Ring
6	001626-40	Nozzle
7	001624-25	Adapter, 1/8" Female x Male Aerator
8	B-0199-01	2.2 GPM Aerator, 55/64-27 UN Female

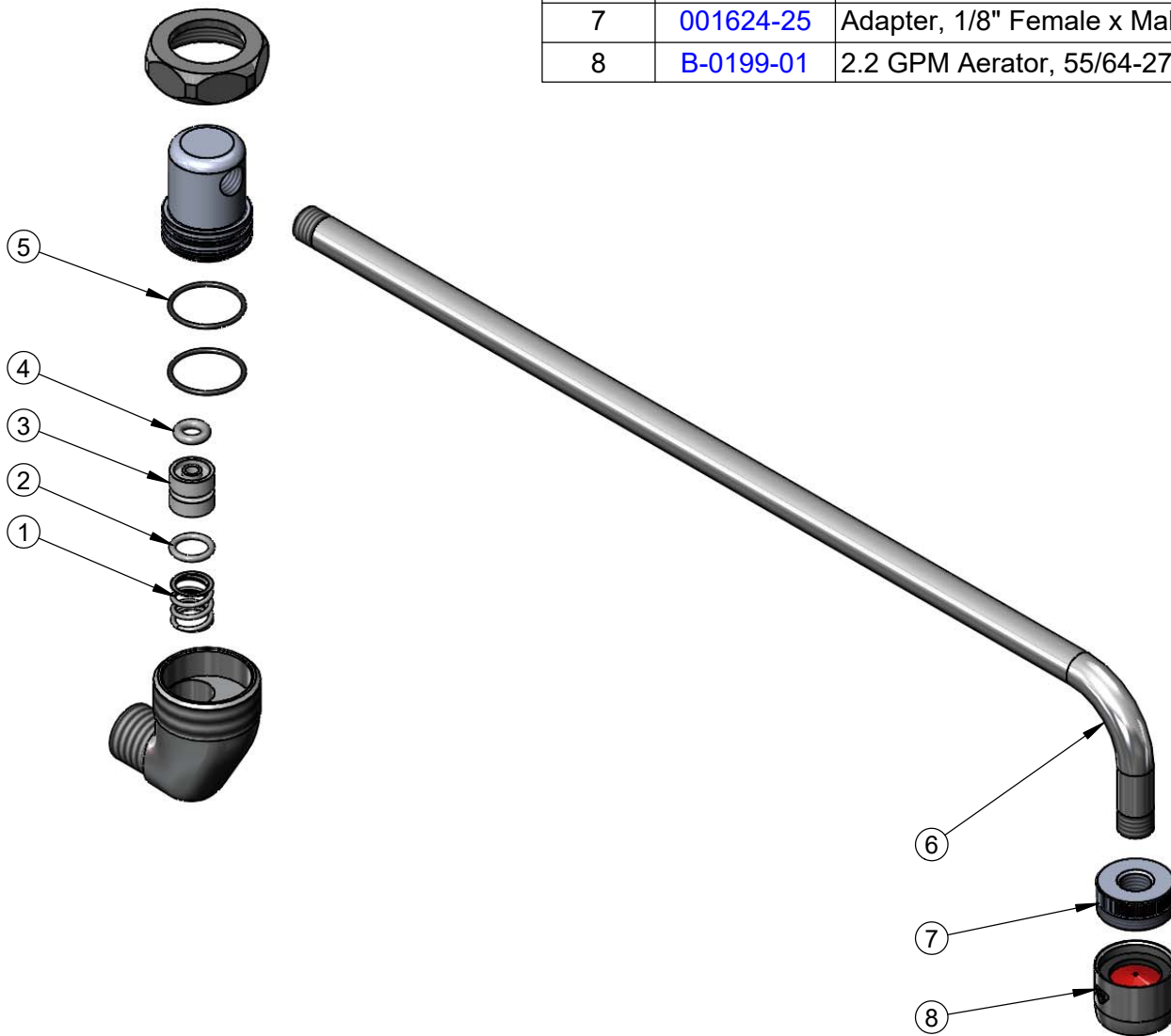

Product Specifications:  
 Range Faucet w/ Swing Nozzle, 2.2 GPM Aerator & 3/8" NPT Male Inlet

Product Compliance:  
 ASME A112.18.1 / CSA B125.1  
 NSF 61 - Section 9  
 NSF 372 (Low Lead Content)  
 ANSI A117.1 (ADA)