



T&S BRASS AND BRONZE WORKS, INC.

2 Saddleback Cove / P.O. Box 1088
Travelers Rest, SC 29690

Model No.

B-0210

Item No.

Travelers Rest, SC: 800-476-4103 • Simi Valley, CA: 800-423-0150 • Fax: 864-834-3518 • www.tsbrass.com



ADA Compliant

This Space for Architect/Engineer Approval

Job Name _____ Date _____

Model Specified _____ Quantity _____

Customer/Wholesaler _____

Contractor _____

Architect/Engineer _____

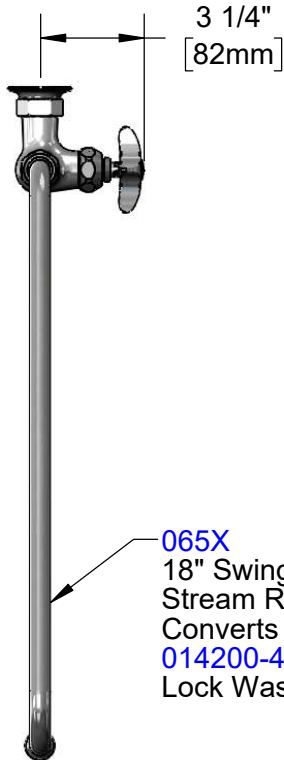

065X
18" Swing Nozzle w/
Stream Regulator Outlet.
Converts to Rigid w/
014200-45
Lock Washer (Included)



Quarter-Turn
Eterna Cartridge w/
Spring Check &
4-Arm Handle w/ Blue
Color Coded Index

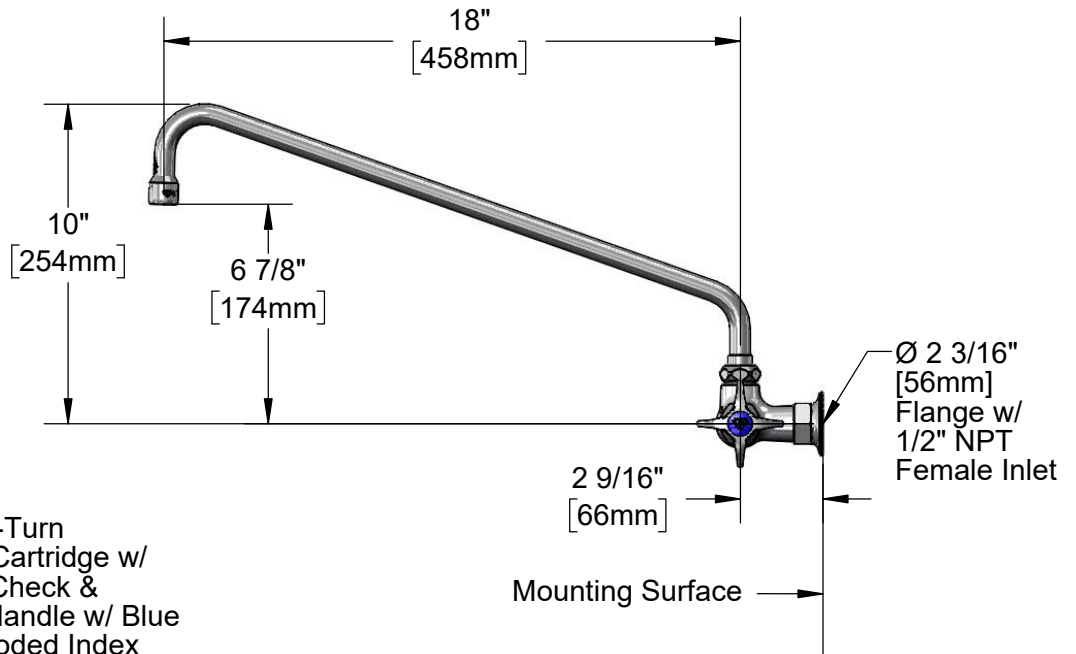

Product Specifications:

Single Hole Single Temperature Wall Mount Faucet, 4-Arm Handle, Quarter-Turn Eterna Cartridge w/ Spring Check, 18" Swing Nozzle w/ Stream Regulator Outlet & 1/2" NPT Female Inlet

Product Compliance:

ASME A112.18.1 / CSA B125.1
NSF 61 - Section 9
NSF 372 (Low Lead Content)
ANSI A117.1 (ADA)



T&S BRASS AND BRONZE WORKS, INC.
 2 Saddleback Cove / P.O. Box 1088
 Travelers Rest, SC 29690

Model No.
B-0210

Item No.

Travelers Rest, SC: 800-476-4103 • Simi Valley, CA: 800-423-0150 • Fax: 864-834-3518 • www.tsbrass.com

ITEM NO.	SALES NO.	DESCRIPTION
1	B-PT	Stream Regulator Outlet
2	065X	18" Swing Nozzle
3	009538-45	Swivel Washer
4	011429-45	Swivel Sleeves (2)
5	001074-45	O-Ring
6	014200-45	Star Washer, Anti-Rotation
7	012443-40NS	Quarter-Turn Eterna Cartridge w/ Spring Check, RTC
8	002521-45NS	4-Arm Handle (New Style)
9	000925-45	Lab Handle Screw
10	018506-19NS	Blue Button Index, Press-in

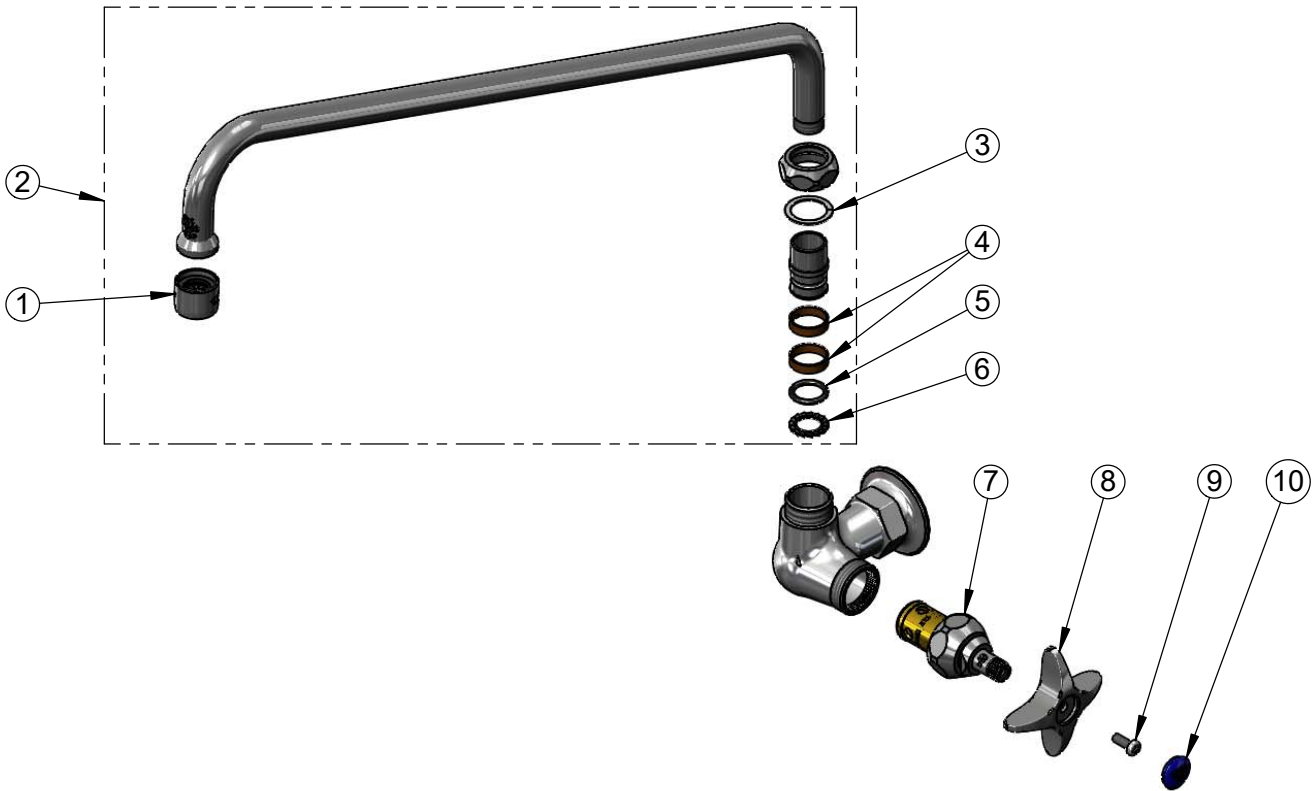

Product Specifications:
 Single Hole Single Temperature Wall Mount Faucet, 4-Arm Handle, Quarter-Turn Eterna Cartridge w/ Spring Check, 18" Swing Nozzle w/ Stream Regulator Outlet & 1/2" NPT Female Inlet

Product Compliance:
 ASME A112.18.1 / CSA B125.1
 NSF 61 - Section 9
 NSF 372 (Low Lead Content)
 ANSI A117.1 (ADA)