

This Space for Architect/Engineer Approval

Job Name _____ Date _____

Model Specified _____ Quantity _____

Customer/Wholesaler _____

Contractor _____

Architect/Engineer _____

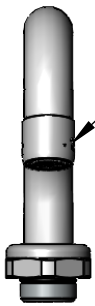
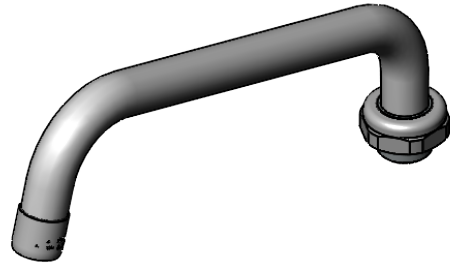
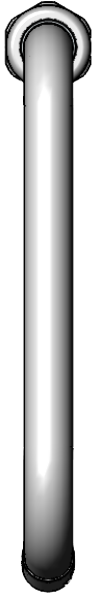

3/4-27 Aerator,
2.2 GPM

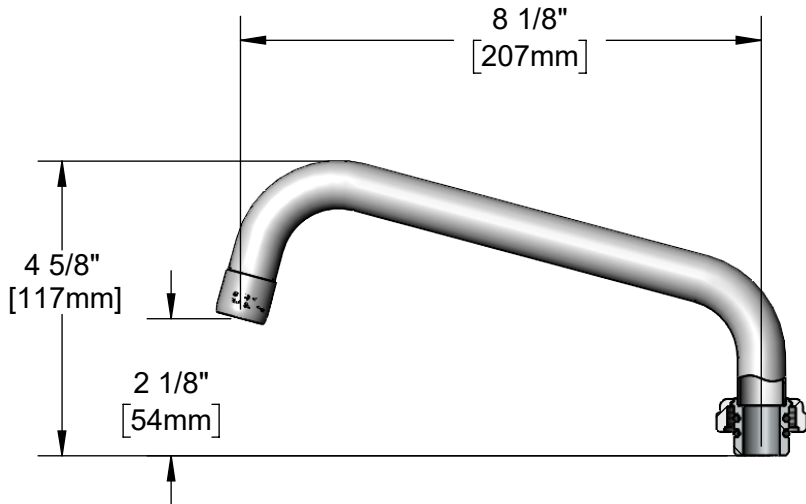

Note:
Conversion to Rigid Requires 014200-45 Lock Washer
(Available Separately)

Model Number

5SP-08A

Product Specifications:

8" Swing Nozzle w/ 2.2 GPM Aerator

Product Compliance:

ASME A112.18.1 / CSA B125.1
NSF 61 - Section 9
NSF 372 (Low Lead Content)

equip
Foodservice
Accessories

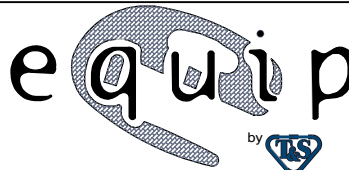

2 Saddleback Cove, P.O. Box 1088
Travelers Rest, South Carolina 29690
Phone: 800.891.4808 Fax: 800.868.0084
equip.tsbrass.com

Drawn: TRK

Checked: JRM

Approved: JHB

Date: 10/30/23

Scale: 1:3

Sheet: 1 of 1