



RELIABILITY BUILT IN™

Limited One Year Warranty (Commercial Applications)

T&S warrants to the original purchaser (other than for purposes of resale) that such product is free from defects in material and workmanship for a period of one (1) year from the date of purchase. During this one-year warranty period, if the product is found to be defective, T&S shall, at its options, repair and/or replace it. To obtain warranty service, products must be returned to...

*T&S Brass and Bronze Works, Inc.
Attn: Warranty Repair Department
2 Saddleback Cove
Travelers Rest, SC 29690*

Shipping, freight, insurance, and other transportation charges of the product to T&S and the return of repaired or replaced product to the purchaser are the responsibility of the purchaser. Repair and/or replacement shall be made within a reasonable time after receipt by T&S of the returned product. This warranty does not cover items which have received secondary finishing or have been altered or modified after purchase, or for defects caused by physical abuse to or misuse of the product, or shipment of the products.

Any express warranty not provided herein, and any remedy for Breach of Contract which might arise, is hereby excluded and disclaimed. Any implied warranties of merchantability or fitness for a particular purpose are limited to one year in duration. Under no circumstances shall T&S be liable for loss of use or any special consequential costs, expenses or damages.

Some states do not allow limitations on how long and implied warranty lasts or the exclusion or limitation of incidental or consequential damages, so the above limitations or exclusions may not apply to you. Specific rights under this warranty and other rights vary from state to state.

Attention California Residents:

⚠ WARNING This product can expose you to chemicals including Lead, Chromium (hexavalent compounds) and Phthalates (DEHP) which are known to the State of California to cause cancer and birth defects or other reproductive harm.

For more information go to
www.P65Warnings.ca.gov.

P/N: 098-003118-45 Rev.6
Date: 07-23-21
Drawn: TED
Checked: GEF 10-31-22
Approved: JHB 11-01-22

Installation and Maintenance Instructions



BASE FAUCET B-0230, B-0231, B-0232 and B-0330

ES

Español:

Instrucciones de instalación y mantenimiento

FR

Français:

Instructions pour l'installation et la maintenance

DE

Deutsch:

Installations- und Wartungsanleitungen

CN

中文:

安装与维护说明

عربي

تعليمات التركيب و الصيانة

AR

Exploded View

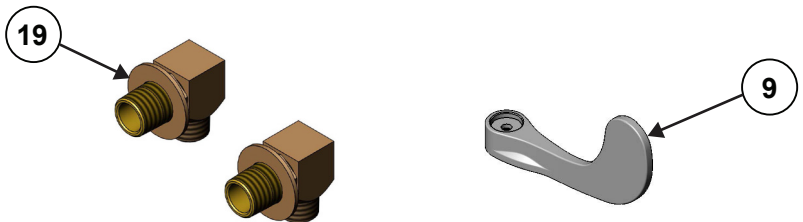
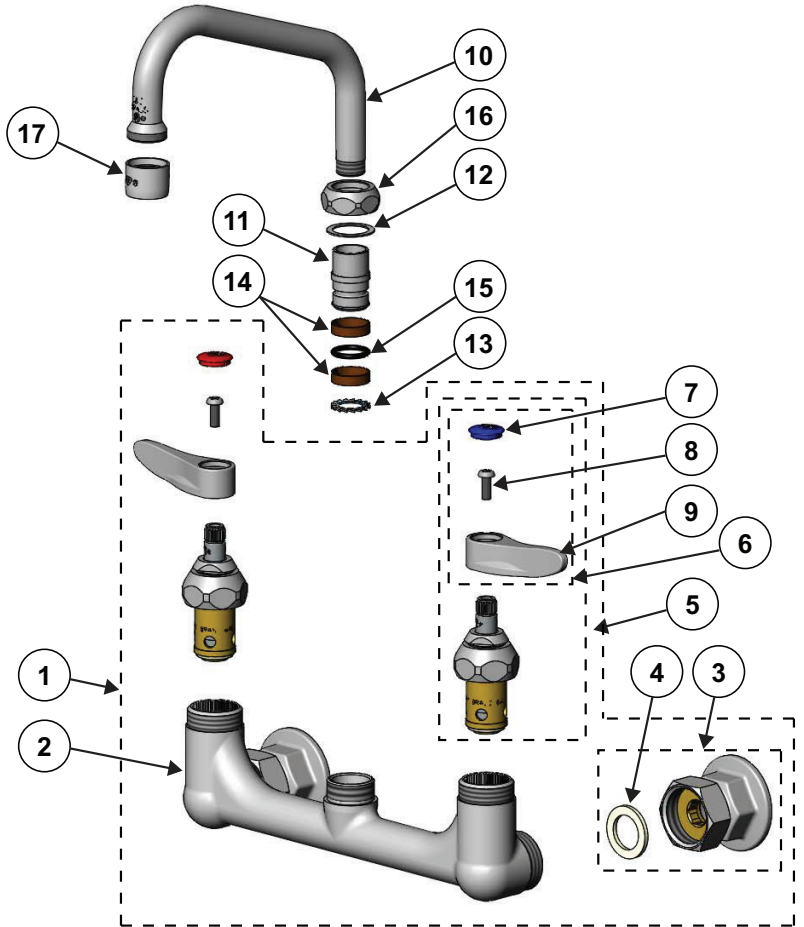

Part Number Guide

Base Faucet Assemblies

1	Asm, Faucet (Swivel)	B-0230-LN
2	Faucet Body (Swivel)	N/A
3	Asm, Coupling Flange	00AA
4	Washer	001019-45
5	Asm, Quarter-Turn Eterna Cartridge (new style)	N/A
	w/ Spring Checks, Handle, Blue Index & Screw, LTC	002711-40NS
	w/ Spring Checks, Handle, Red Index & Screw, RTC	002712-40NS
5	Asm, Quarter-Turn Cerama Cartridge (new style)	N/A
	w/ Check Valve, Handle, Blue Index & Screw, LTC	012447-25NS
	w/ Check Valve, Handle, Red Index & Screw, RTC	012446-25NS
6	Handle, Lever - Cold w/ Index & Screw	001636-45NS
	Handle, Lever - Hot w/ Index & Screw	001637-45NS
7	Index, Button	N/A
	Cold (Blue)	018506-19NS
	Hot (Red)	001193-19NS
8	Screw, Handle	000925-45
9	Handles	N/A
	Lever Handle	001638-45NS
	Wrist Action Handle	B-WH4-NS
13	Lock Washer	014200-45
19	*Optional Supply Connector Kit	B-0230-K

*Order separately

Nozzle Assemblies

10	Asm, Nozzle Swing (<i>includes items 10-17</i>)	N/A
	Nozzle, 6"	Spec Drawing Parts List
	Nozzle, 12"	Spec Drawing Parts List
	Nozzle, 18"	Spec Drawing Parts List
	Asm, Gooseneck Nozzle (<i>includes items 10-17</i>)	Spec Drawing Parts List
11	Swivel Piece	N/A
12	Washer, Swivel Piece	009538-45
	Repair Kit (<i>includes items 14-15</i>)	011643-45
14	Sleeve, Swivel (2)	011429-45
15	O-Ring	001074-45
16	Nut, Swivel	N/A
17	Outlet Device	Spec Drawing Parts List
18	Grease Tube	011676-45

EN **Nozzle Installation:**

Note: Nozzles should be installed first.

1. If converting to a rigid nozzle, place no.13 into faucet body opening before installing nozzle.
2. Insert no.9 or no.10 into no.2 and rotate to front of sink.
3. Tighten no.16 firmly with a wrench.

For swivel repair or replacement of (o-ring) no.15 and (sleeves) no.14:

4. Insert one no.14 onto no.11. Install no.15 on no.11 and lubricate liberally with provided no.18. Install second no.14 onto no.11. (See Enlarged View)

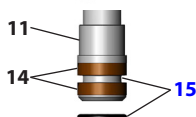
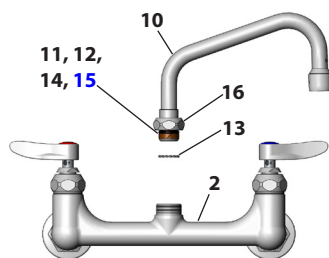

Enlarged View

Dibujo Ampliado

vue agrandie

Vergößerte Ansicht

放大图

العرض المكبر

ES **Instalación de la boquilla:**

Nota: Primero se deben instalar las boquillas.

1. Si se convierte en una boquilla rígida, coloque el no. 13 en la abertura del cuerpo del grifo antes de instalar la boquilla.
2. Inserte el no. 9 o el no. 10 en el no. 2 y gírelo hacia el frente del lavabo.
3. Ajuste firmemente el no. 16 con una llave.

Para reparar el eslabón giratorio o reemplazar el no. 15 (junta tórica) y el no. 14 (mangas):

4. Inserte un no. 14 en el no. 11. Instale el no. 15 en el no. 11 y lubrique generosamente con el no. 18 que se proporcionó. Inserte el segundo no. 14 en el no. 11. (Ver la vista aumentada)

FR **Installation de la buse :**

Remarque : Les buses doivent être installées en premier.

1. En cas de conversion vers une buse rigide, placez le N°13 dans l'ouverture du corps du robinet avant d'installer la buse.
2. Insérez le N°9 ou le N°10 dans le N°2 et faites pivoter vers l'avant de l'évier.
3. Serrez bien le N°16 avec une clé.

Pour la réparation du pivot ou le remplacement du (joint torique) No 15 et des (manchons) No14:

4. Insérez un N°14 par-dessus un N°11. Installez le N°15 sur le N°11 et lubrifiez généreusement avec le N°18 fourni. Installez le second N°14 sur le N°11. (Voir la vue agrandie.)

DE **Einbau der Düse:**

Hinweis: Düsen müssen zuerst eingebaut werden.

1. Falls auf eine starre Düse umgebaut wird, Nr. 13 in den Armaturenkörper einsetzen, bevor die Düse eingebaut wird.
2. Nr. 9 oder Nr. 10 in Nr. 2 einsetzen und zur Vorderseite des Waschbeckens drehen.
3. Nr. 16 mit einem Schraubenschlüssel fest anziehen.

Für die Reparatur des Schwenkarms oder den Austausch von (O-Ring) Nr. 15 und (Manschetten) Nr. 14:

4. Eine Nr. 14 in Nr. 11 einsetzen. Nr. 15 auf Nr. 11 montieren und mit dem mitgelieferten Schmiermittel Nr. 18 großzügig schmieren. Zweite Nr. 14 auf Nr. 11 montieren. (Siehe vergrößerte Ansicht)

CN

水嘴安装:

注意: 水嘴应该最先安装

1. 如果需要转换为固定式鹅颈, 只需在安装水嘴前将**13号**装入龙头本体的开口内。
2. 将**9号**或**10号**装入**2号**中并旋转至水槽的前方。
3. 用扳手将**16号**拧紧。

旋转维修或替换15号 (O型圈) 及15号 (套筒) :

4. 将**14号**装到**11号**上, 将**15号**装到**11号**上, 并在**18号**上涂上大量的润滑油。将另一个**14号**安装到**11号**上。(详见放大图)

تركيب الفوهة: **AR**

ملاحظة: ينبغي تركيب الفوهات أولاً.

1. إذا كنت تنتقل إلى فوهة ثابتة، ضع الرقم **13** على فتحة هيكل الصنبور قبل تركيب الفوهة.
2. أدخل الرقم **9** أو الرقم **10** في الرقم **2** ولف إلى مقدمة الحوض.
3. شد الرقم **16** بإحكام باستخدام مفتاح ربط.

لإصلاح الماسورة الدورانية أو استبدال الرقم **15** (الحلقة المستديرة) والرقم **14** (الأكمام):

4. أدخل رقم **14** واحدًا في الرقم **11**. ركب الرقم **15** على الرقم **11** وضع الشحم بغزارة باستخدام رقم **18** المزود. ركب الرقم **14** الثاني على الرقم **11**. (انظر العرض المكبر)

EN

Faucet Installation:

5. Shut off water supply and drain lines. Drill (2) two holes, approximately 1" [2.5 cm] diameter in wall with 8" [20 cm] centers, where you are installing no.1.
6. Apply teflon tape or pipe joint compound to water supply lines.
7. Connect no.2 to water supply lines by attaching no.3 with **eccentric centers** onto nipple **supplied by others** and tighten no.3 against wall. **Make sure no.4 is in place. Nut behind wall to be supplied by others.** Trim supply lines if necessary.
8. Turn on water supply and check for leaks.

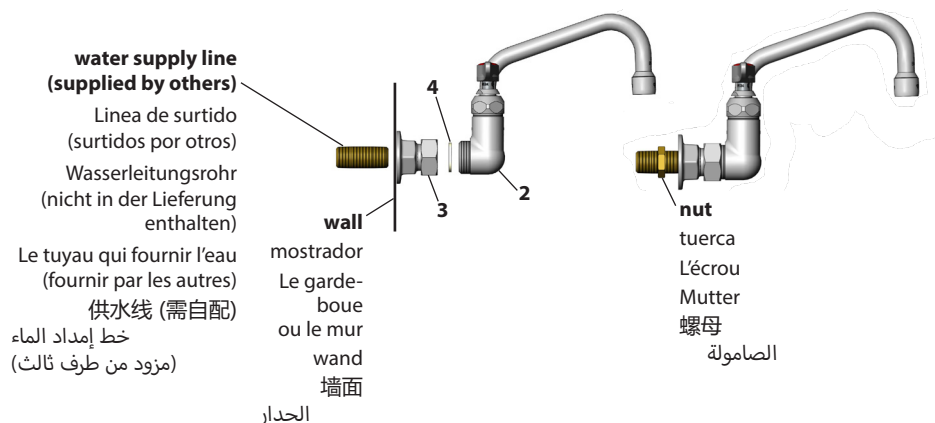
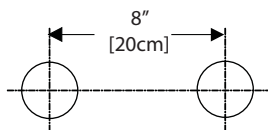

ES

Instalación del grifo:

5. Corte el suministro de agua y drene las líneas. Perfore dos (2) orificios con un diámetro aproximado de 2.5 cm (1") en la pared con centros de 20 cm (8"), en donde instale el no. 1.
6. Aplique cinta de teflón o compuesto para uniones de tubería a las líneas de suministro de agua.
7. Conecte el no. 2 a las líneas de suministro de agua conectando el no. 3 con **centros excéntricos** sobre la boquilla suministrada por terceros y ajuste el no. 3 contra la pared. **Asegúrese de que el no. 4 esté en su sitio. La tuerca que se coloca detrás de la pared debe ser suministrada por terceros.** Recorte las líneas de suministro si es necesario.
8. Abra el suministro de agua y compruebe que no haya fugas.

FR

Installation du robinet :

5. Coupez l'alimentation en eau et les conduites d'évacuation. Percez (2) deux trous d'environ 1 po. [2,5 cm] de diamètre dans le mur avec les axes écartés de 8 po. [20 cm], à l'endroit où vous installez le N°1.
6. Appliquez du ruban de téflon ou un composé pour joints sur les conduites d'alimentation en eau.
7. Raccordez le N°2 aux conduites d'alimentation en fixant le N°3 avec des **centres excentrés** sur le mamelon **d'autres fournisseurs** et serrez le N°3 contre le mur. **Assurez-vous que le N°4 est bien en place. L'écrou derrière le mur est doit être fourni par d'autres fournisseurs.** Coupez les conduites d'alimentation si nécessaire.
8. Ouvrez l'arrivée d'eau et recherchez des fuites.

DE Montage der Armatur:

5. Wasserzufuhr ausschalten und Rohre entleeren. Zwei (2) Löcher, ca. 1" [2,5 cm] Durchmesser, mit 8" [20 cm] Abstand zwischen den Mitten bohren, wo Nr. 1 installiert werden soll.
6. Teflonband oder Rohrleitungs-Dichtmittel an die Wasserzulaufleitungen anbringen.
7. Nr. 2 an die Wasserzulaufleitungen anschließen; hierzu Nr. 3 mit **exzentrischen Mitten** an den **bauseitigen** Stutzen anbringen und Nr. 3 gegen die Wand festziehen. **Sicherstellen, dass Nr. 4 angebracht ist. Die Mutter hinter der Wand wird bauseitig bereitgestellt.** Zulaufleitungen nach Erfordernis kürzen.
8. Wasserzufuhr anschalten und auf Dichtigkeit prüfen.

CN 龙头安装:

5. 关闭供水和排水阀门。在你准备安装1号的墙面上开2个孔，直径约1" [2.5 cm]，间距为8" [20 cm]。
6. 在供水管上缠上生料带或管接头。
7. 将偏心的3号安装至自配的接头上，将2号连接到供水管上，并将3号拧紧在墙壁上。**请确保4号在准确的位置上。墙后的螺母需要自配。**如有必要可减短供水管。
8. 打开供水并检查是否漏水

AR تركيب الصنبور:

5. اقل خط إمداد الماء وخطوط التصريف. احفر حفتين بقطر 1 بوصة [2.5 سم] تقريبًا في الجدار بمراكز 8 بوصة [20 سم]، حيث تركيب الرقم 1.
6. ضع شريط تيفلون أو معجون أطراف الأنايب على خطوط إمداد الماء.
7. وصل الرقم 2 بخطوط إمداد الماء من خلال وصل الرقم 3 مع المراكز اللامتراكزة على النيبييل المزود من طرف ثالث لشد الرقم 3 على الجدار. **تأكد من أن الرقم 4 في مكانه. يتم توفير الصامولة على الجدار من طرف ثالث.** شذب خطوط الإمداد إذا لزم الأمر.
8. افتح خط إمداد المياه وافحص وجود تسريبات.

RELATED T&S BRASS PRODUCT LINE



B-0352-04

Surgical Sink Faucet with
Build-In Stops

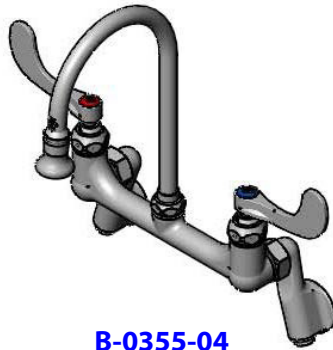

B-0355-04

Surgical Sink Faucet with
Adjustable Inlet and
Loose Key Stops

T&S BRASS AND BRONZE WORKS, INC.

A firm commitment to application-engineered plumbing products

2 Saddleback Cove, P.O. Box 1088,
Travelers Rest, SC 29690

Phone: (864) 834-4102

Fax: (864) 834-3518

E-mail: tsbrass@tsbrass.com

T & S Brass-Europe
'De Veenhoeve'

Oude Nieuwveenseweg 84

2441 CW Nieuwveen

The Netherlands



RELIABILITY BUILT IN™