



T&S BRASS AND BRONZE WORKS, INC.
 2 Saddleback Cove / P.O. Box 1088
 Travelers Rest, SC 29690

Model No.
000379-20

Item No.

Travelers Rest, SC: 800-476-4103 • Simi Valley, CA: 800-423-0150 • Fax: 864-834-3518 • www.tsbrass.com

This Space for Architect/Engineer Approval

Job Name _____ Date _____

Model Specified _____ Quantity _____

Customer/Wholesaler _____

Contractor _____

Architect/Engineer _____



3/8" NPT
 Male Thread
 Typ Both Ends

3/8" NPSL
 Male Thread

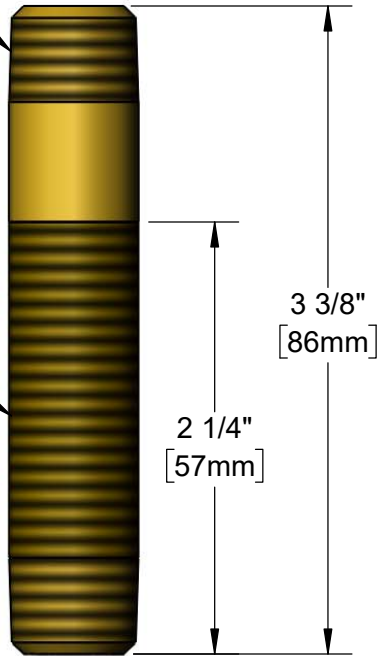

Product Specifications:
 Brass 3/8" NPT Supply Nipple

Product Compliance:
 NSF 61 - Section 9
 NSF 372 (Low Lead Content)