



Sunpak S34-TSR

Outdoor Gas Infrared Patio Heater

NOT FOR USE IN RESIDENTIAL DWELLINGS

Installation, Operation and & Maintenance Instructions



Note: Heater above shown with optional Face Trim

Installer: Please take the time to read and understand these instructions prior to installation. Installer must provide a copy of this manual to the owner.

Owner: Keep this manual in a safe place in order to provide your service technician with the necessary information.

Warning: These instructions are intended for qualified personnel, specifically trained and experienced in the installation and repair of this type of equipment and related system components.

WARNING: California Proposition 65

IF NOT INSTALLED, OPERATED AND MAINTAINED IN ACCORDANCE WITH THE MANUFACTURER'S INSTRUCTIONS, THIS PRODUCT CAN EXPOSE YOU TO SUBSTANCES IN THE FUEL OR FROM COMBUSTION INCLUDING CARBON MONOXIDE RESULTING IN DEATH OR SERIOUS ILLNESS AND WHICH ARE KNOWN TO THE STATE OF CALIFORNIA TO CAUSE CANCER, BIRTH DEFECTS OR REPRODUCTIVE HARM.

For more information go to www.P65WARNINGS.CA.GOV



Infrared Dynamics, Inc

3830 Prospect Avenue



Yorba Linda, CA 92886

<http://sunpak.us>

For Local Distributor Listing

Call Us Toll Free

(888) 317-5255

<p>Table of Contents</p> <ol style="list-style-type: none"> 1. Warnings 2. Basic Operation 3. Heater Layout and Design 4. Installation / Service 5. Replacement Parts 6. Trouble Shooting Guide 7. Warranty 	<p>Sunpak heaters work like the sun projecting radiant heat down to warm your patio and guests. This heater was designed for outdoor installation; however, breezes will affect the heating efficiency, and severe weather conditions will cause the safety system to shut down the heater. For your safety you must read and understand the following warnings before continuing.</p>
<div style="display: flex; justify-content: space-around;"> <div style="text-align: center;">  WARNING </div> <div style="text-align: center;">  WARNING </div> </div>	
<p>Improper installation, adjustment, alteration, service or maintenance can cause death, injury or property damage. Read and understand the installation, operating and maintenance instructions thoroughly before installing or servicing this equipment.</p>	<p>Storage of gasoline and other flammable vapors and liquids in the vicinity of this or any other appliance may result in fire or explosion. DO NOT store or use gasoline or other flammable vapors and liquids in the vicinity of this or any other appliance. Always maintain clearance to combustibles as specified.</p>
<div style="text-align: center;">  WARNING </div>	
<p>Not for use in residential dwellings. This heater is not approved for use in any indoor residential application. This includes, but is not limited to, attached garage, solarium, living quarter, etc. Installation in residential indoor space may result in death, asphyxiation, serious injury, or property damage.</p>	<p>For Your Safety If you smell gas:</p> <ul style="list-style-type: none"> • Shut off gas to the appliance • Extinguish any open flame • DO NOT touch any electrical switch • Call your gas supplier. DO NOT use any phone in your building. • Follow the gas supplier's instructions. • If you cannot reach your gas supplier call the fire department

Basic Heater Operation

Sunpak S34 TSR is an outdoor gas-fired infrared heater which is operated with a wireless remote control. The heater can be operated at a High setting with an input of 34,000 BTU/Hr or at a LOW setting of 25,000 BTU/Hr. Each heater comes with wireless operating remote controls that are pre-programmed for that heater. The number located on the louvered end of the heater corresponds to the number on the remote control. Should the original remote control become lost, additional remote controls can be purchased. However, the heater will need to be re-programmed for the new remote control.

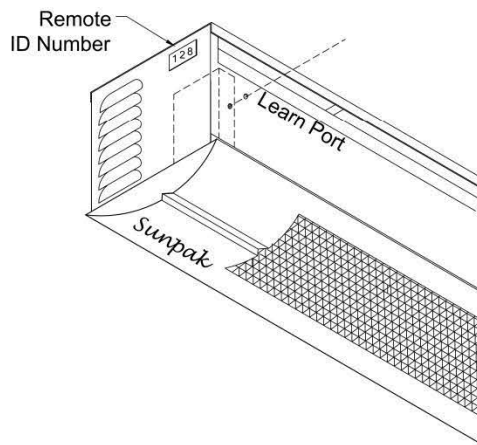

The Sunpak S34-TSR should **always** be started up and operated on the HIGH mode for the first 5 minutes to allow the heater to warm up. Starting up the heater on the LOW mode before the heater is warmed up may cause the heater to shut down prematurely. To correct this situation press the OFF button followed by the ON button and the HI button. Always PRESS the button for at least 1 second to allow proper transmission of the remote signal.

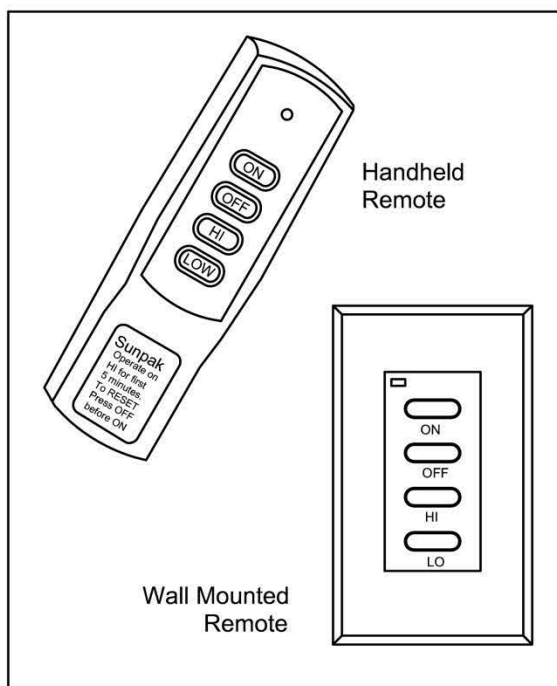

Sunpak heaters have a spark ignition and electronic flame safety control. The pilot is only ON while the heater is operating. If the flame safety sensor fails to sense flame at the pilot, the heater will shut down and lockout. This may happen due to low gas pressure or a gusty wind. Should the heater lockout you may be able to hear a faint beeping from the heater control. To restart the heater, first press the OFF button before restarting the heater.

Although these heaters are designed for outdoor installation and use, it is important that the wireless remote control(s) be protected from the weather. Should the remote control become wet, it may be necessary to replace the control. Keep controls out of reach of children

Each control has four buttons (ON OFF HI LOW). The remote controls are powered by batteries. The remote control has an approximate 25 foot line of sight range. Weak batteries can limit the effective range of operation.

Device	Battery
Wall Remote	2032 Button Type
Handheld	21/23 – 12V

Heater Layout and Design

Sunpak® heaters were specifically designed to provide heated comfort in an outdoor environment. They have been used on outdoor patios across the United States and Canada for over 30 years. When properly integrated into a patio design, Sunpak® heaters generally increase the comfort level 5 to 10° Fahrenheit outdoors. The heating effectiveness will depend on air temperature, wind velocity and other factors. Whenever possible other local Sunpak® installations should be reviewed to determine the effectiveness for regional environments.

The environments in which Sunpak® heaters are utilized vary greatly. As an outdoor rated heater it has passed basic wind and rain tests. This does not mean the heater cannot be damaged by the environment or when operated in very windy conditions. For this reason it is strongly suggested that heaters be inspected and if necessary repaired annually or before each heating season.

The variable environments in which Sunpak® heaters are applied means that these general guidelines are generated by necessity and may need to be refined for local conditions. These guidelines are to be used in combination with the installation instructions.

Patio Design Consideration

Heater placement is critical for effective and efficient patio heating. If heaters are placed too close together or mounted too low, people become uncomfortable. If heaters are placed too far apart on a breezy, wind-swept patio the patio may never get warm.

Sunpak® heaters work best if they are placed in areas of the greatest heat loss, such as the open side of a semi-protected patio area. The Sunpak® heater may be mounted at up to a 30 degree angle or face down. Note that the top clearances required from combustible material increases when heaters are at an angle. The heater must always be horizontal to the floor. **Never mount the heater in the vertical position.**

Breezy conditions must be considered when heating any patio. Windbreaks can be extremely effective in increasing comfort and reducing heating costs. Windbreaks must be designed in such a way to allow for the necessary fresh air and ventilation for proper heater operation (see ventilation of installation section).

Sunpak heaters must always be operated in a location that allows uniform air pressure around the heater. If only part of the heater is located in a wind protected zone damage to the heater may occur. Time should be taken to observe how the wind will affect the heaters under local conditions.

MINIMUM CLEARANCE FROM COMBUSTIBLE MUST BE MAINTAINED (see chart on page 6 & 7)

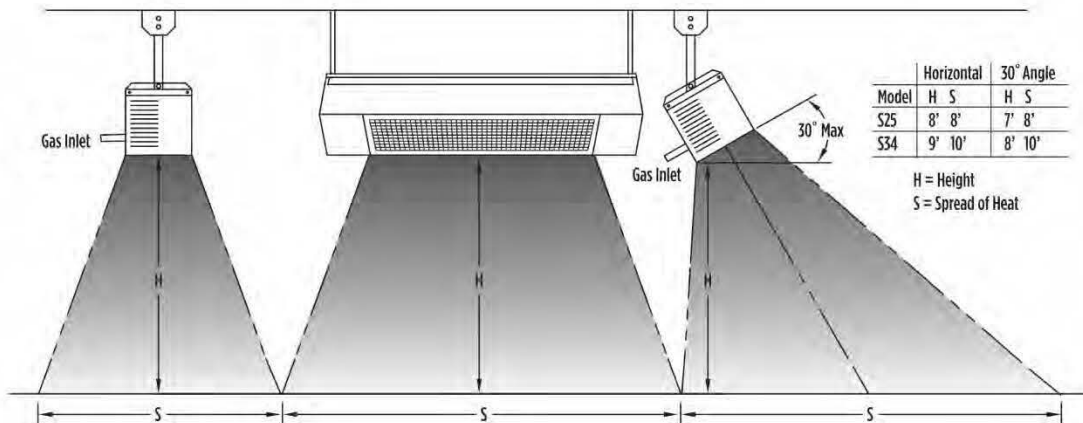

SUNPAK will raise the comfort level 5-10° Fahrenheit outdoors. The above coverage table was based on still breeze conditions. Under windy conditions more heat will be required. It is recommended that a windswept patio be designed with wind breaks to stabilize the patio environment. Wind breaks shall NOT interfere with the ventilation or combustion air requirements of the heater(s) and meet clearance for combustible requirements listing on page 6 & 7.

ANGLE MOUNTING: Most applications of the SUNPAK heater may be angle-mounted to a maximum of 30° to accommodate mounting the heaters around the edges of the patio. Note that the top clearance to combustibles increases when heater is tipped from the horizontal.

NOTE: Local codes may have special requirements regarding head clearance requirements. Some local codes require all portions of overhead radiant heaters to be located at least 8 feet above the floor.

Sunpak® Infrared Heater Location

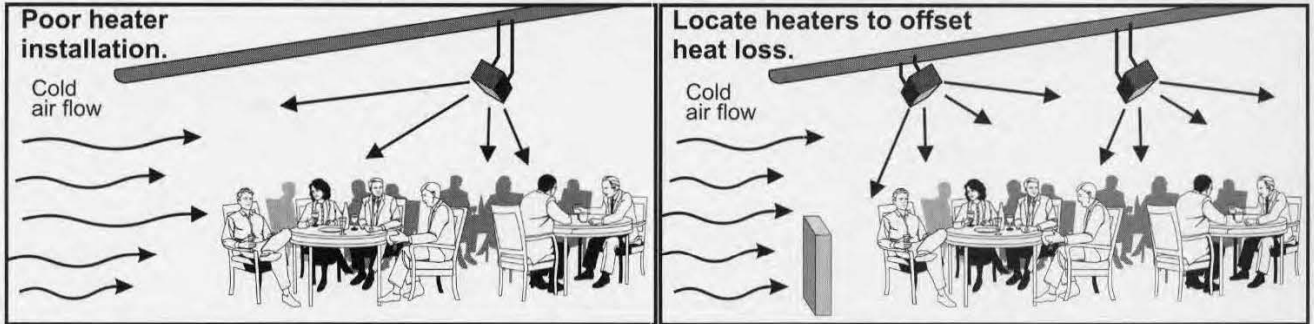

Suggested Installation Configurations

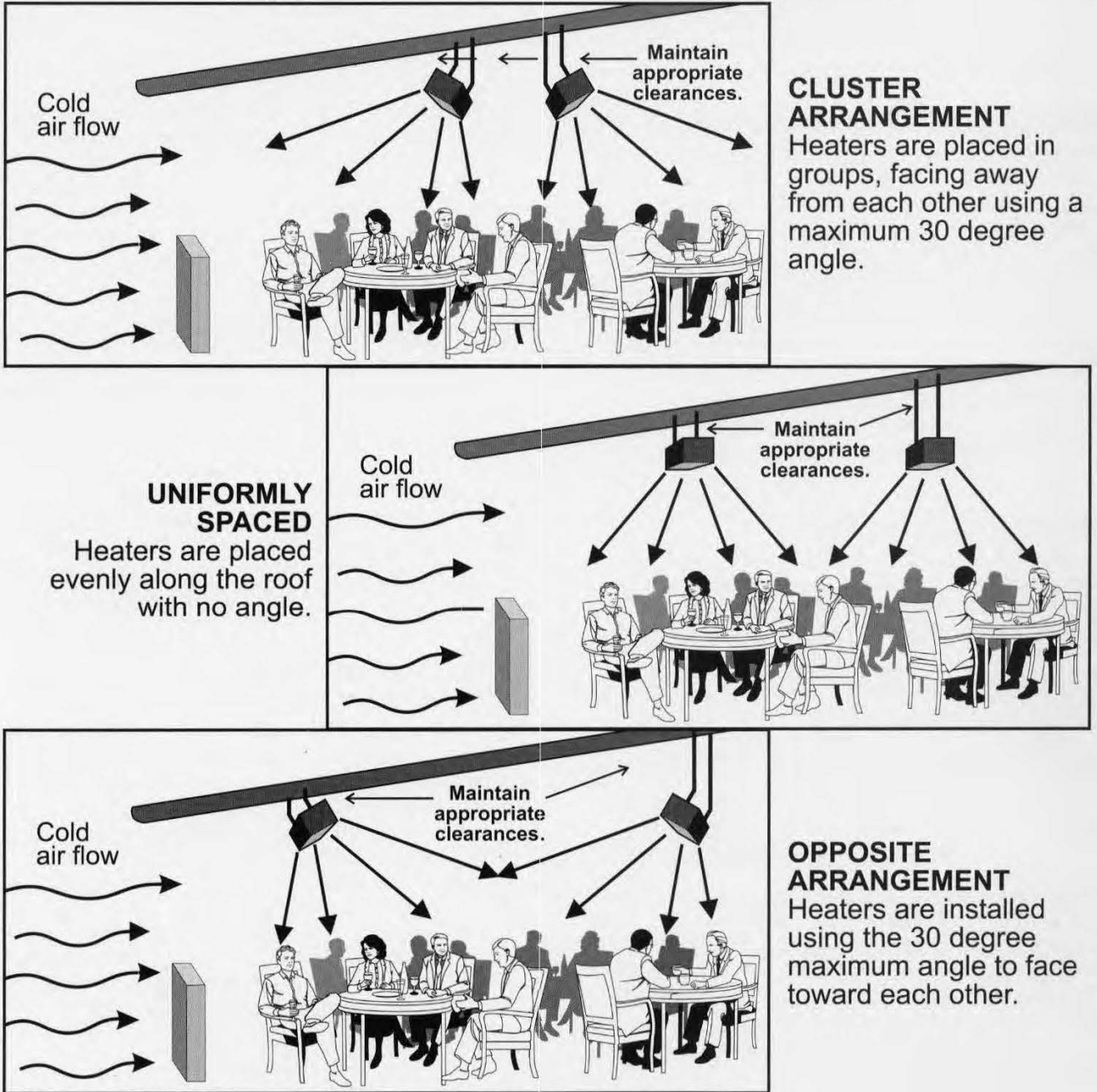

SUNPAK® S34-TSR INFRARED HEATERS

SUNPAK® INFRARED HEATERS

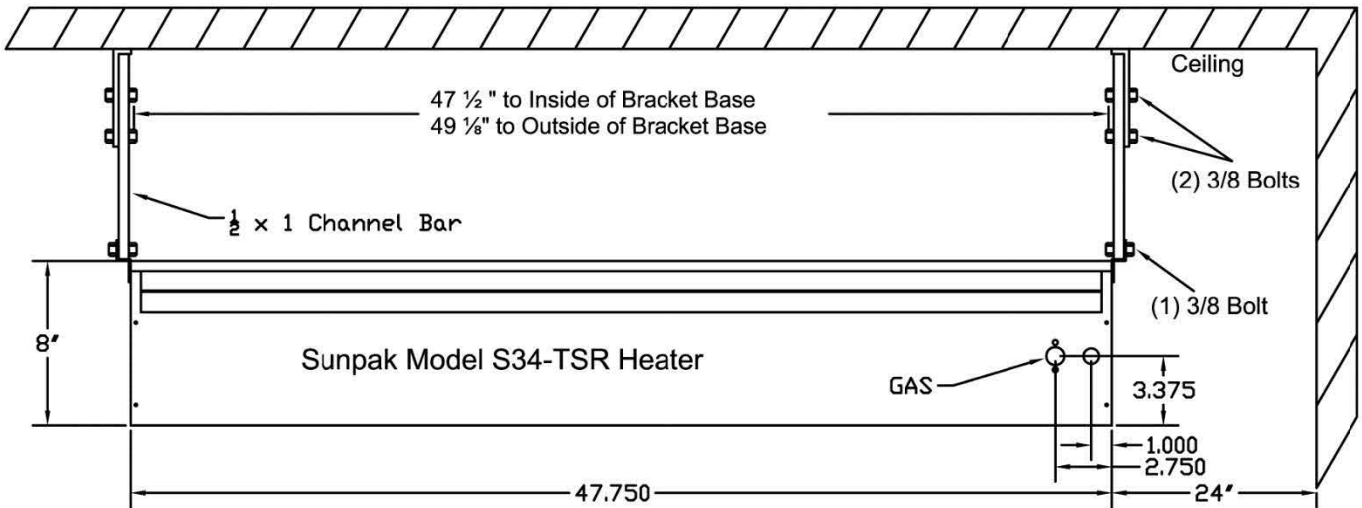
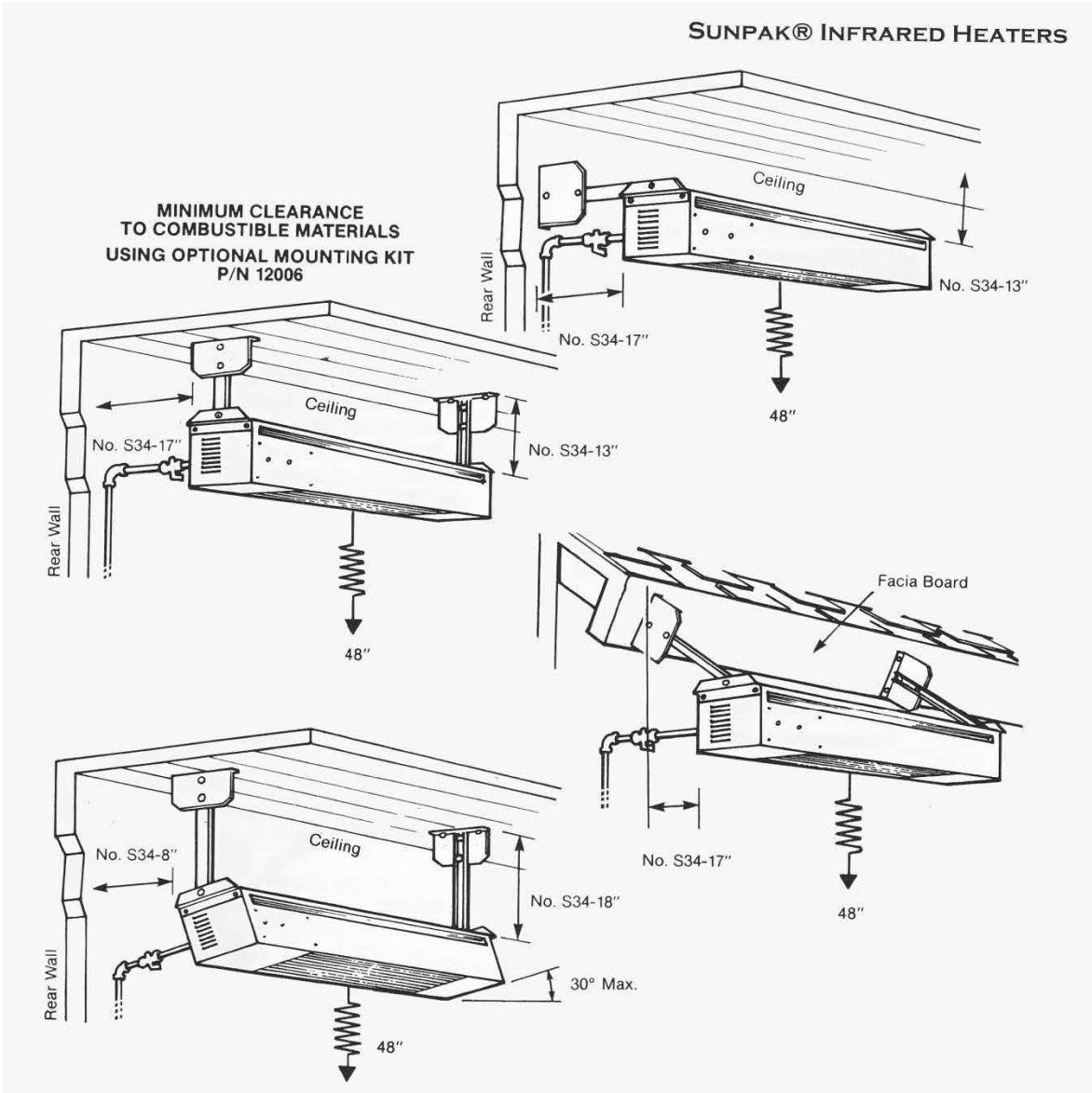

Warning: Heater must be level in the lengthwise direction.

Installation/Service Instruction

Receiving Equipment

On receipt of equipment it is suggested that a visual inspection be made for external damage to the carton. If the carton is damaged, a note should be made on the Bill of Lading when signing for the equipment. Remove the heater from the carton. **If there is damage, report the damage to the carrier immediately.**

INSTALLATION INSTRUCTIONS

Important Notice

These instructions are intended for qualified personnel, specifically trained and experienced in the installation of this type of equipment and related system components. Some states or provinces require installation and service personnel to be licensed. If your state or province is such, be sure your contractor bears the appropriate license. Persons not qualified shall not attempt to fix this equipment nor attempt repairs.

WARNING

Asphyxia, Explosion or Fire

Improper installation, adjustment, alteration, service or maintenance may create a hazard resulting in asphyxiation, explosion or fire, or damage to the equipment.

Code Requirements

Installation must be in accordance with local codes, or in the absence of local codes, with the latest edition of the National Fuel Gas Code, ANSI Z224 and National Electrical Code ANSI/NFPA 70, and for Canada, the latest edition of CAN/CGA-B149.1 and B149.2 and Canadian Electrical Code, CSA C22.1 Part 1 and Part 2.

- Heaters to be installed in Aircraft hangars must be installed in accordance with American National Standards for Aircraft Hangars, ANSI/NFPA No. 409.
- Heaters to be installed in Public Garages must be installed in accordance with NFPA No. 88A, Standards for Parking Structures.
- Heaters must be installed so that minimum clearances marked on the heaters will be maintained from vehicles parked below the heater.
- Each heater must be electrically grounded in accordance with the National Electrical Code, ANSI/NFPA 70, when an external electrical source is utilized. In Canada, the CSA Canadian Electrical Code, C22.1 Part 1 applies.

Gas Supply

The gas inlet supply pressure and manifold pressure required for each heater are listed below. For gas supply line pressures in excess of ½ psi, consult with your gas service provider or the factory.

Gas Inlet Pressure	Nat Gas	Propane
Maximum Pressure	½ psi	½ psi
Minimum Pressure	6" W.C.	11" W.C.
Manifold Pressure	5" W.C.	10" W.C.

It is critical that the gas piping system be adequately sized for all the gas appliances it serves.

Clearances

Each heater must be installed such that the following "Minimum Clearance to Combustible Materials" are maintained. Combustible materials include wood, compressed paper, plant fibers, plastic, Plexiglas or other materials capable of being ignited and burned. Such materials shall be considered combustible even though flame-proofed, fire retardant treated or plastered. Additional clearance may be required for glass, painted surfaces, vinyl siding or other materials which may be damaged by radiant or convection heat.

Adequate space around each heater is required even when the materials surrounding the heater are non-combustible to provide adequate combustion air and ventilation of exhaust gases. Heaters should never be located in a ceiling recess or ceiling enclosure.

The stated clearance to combustible materials represents a surface temperature of 90°F (32°C) above room temperature. Building materials with a low heat tolerance (such as plastic, vinyl siding, canvas, tri-ply, etc.) may be subject to degradation at lower temperatures. It is the installer's responsibility to assure that adjacent materials are not subject to degradation.

In locations used for storage of combustible materials, signs shall be posted to specify the maximum permissible stacking height to maintain required clearances from the heater to combustible materials.

OPTIONAL MOUNTING KIT (#12006): Optional Mounting Kit is included in some packages. Whether the mounting kit is used or not, minimum clearance from combustibles must be observed as follows:

WARNING: The clearances shown below are also applicable to vehicles parked below heaters.

	Input	Side	Rear	Ceiling	Below	Mtg.
Model	BTUH	In	In	In	In	Angle
S34	34,000	24"	17"	13"	48"	HORIZ
S34	34,000	24"	8"	18"	48"	30°
						MAX

SUNPAK® S34-TSR INFRARED HEATERS

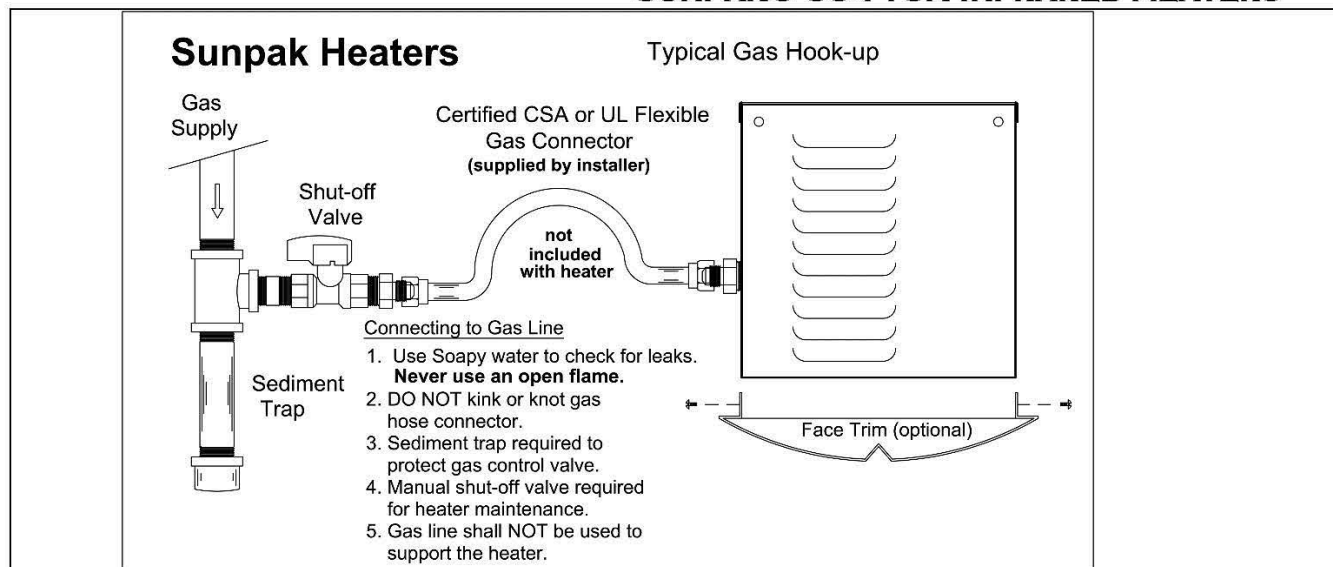

Heater Mounting and Support

Heaters shall be mounted in a fixed position independent of gas and electrical supply line. Hangers and brackets shall be of noncombustible material.

Heaters subject to vibration shall be provided with vibration isolating hangers.

Suitable materials for hanging infrared heaters are steel pipe, steel channel, or fabricated hangers of at least 16-gage material. Hanger and brackets must be secured with adequate anchor to a secure structure using good building practices. Additional bracing to protect against seismic forces may be required in seismically active areas. Never mount heater to a moving object such as a trailer, motor home, boat, etc.

Gas Piping

1. A minimum pipe size of ½" is required for inlet piping. A ½" lever handled shut-off gas valve should be installed within 6 feet of the appliance for servicing and as emergency shutoff to the unit.
2. Check with local and state plumbing and heating codes regarding sizing of gas lines.
3. All gas pipe connections to the heater(s) must be sealed with a gas pipe compound resistant to liquefied petroleum gases.
4. Installation of a drip leg or sediment trap in the gas supply line going to each heater is required to minimize the possibility of any loose scale or dirt within the gas supply line from entering the heater's control system.
5. When checking for gas leaks, do not use an open flame. Use a soap and water solution.
6. For gas supply line pressures in excess of ½ psig, consult the factory or your local representative.
7. Installation of 1/8" N.P.T. plugged tap accessible for test gage connections is required upstream of the gas supply connections to the heater.
8. Never use pipe sealing compound on brass to brass flared fittings.

Electrical

1. The Power Adapter included provides 7.5 VDC to the heater. The Power Adapter has a 24 inch wire lead connected to the main heater module by two slide connectors (see page 10). The low voltage connection can be extended using 18 GA outdoor rated thermostat wire up to 50 feet. For distances greater than 50 feet 16 GA or larger wire will be necessary.
2. If any of the original wire supplied inside the appliance must be replaced, it must be replaced with wiring material having a temperature rating of at least 105° Centigrade.

SUNPAK® S34-TSR INFRARED HEATERS

Ventilation

1. It is required that areas above the heater be properly vented to allow for necessary combustion air and removal of combustion gases.
2. Heaters shall be provided with natural or mechanical means to supply and exhaust at least 4 cfm per 1,000 BTU per hour of heater input. Exhaust openings for removing the flue products shall be above the level of the heaters.
3. Heater ventilation must comply with state and local codes. **Never use heater in enclosed area.**

Fire Sprinklers

Fire Sprinklers must be located at an appropriate distance from each heater to avoid accidental activation of the sprinkler. Ethylene glycol or propylene glycol must never be used in fire sprinkler systems where heaters are present as these substances may become flammable when heated. A fire sprinkler professional must be consulted when heaters are installed where fire sprinklers are present to insure that heaters and the fire sprinkler system are properly integrated. Specific guidelines can be found in NFPA 13 regarding design and specifications for Fire Sprinkler Systems near heaters.

Initial Start-Up Procedure

(Read entire Procedure First)

1. Before turning ON your new heater make sure:
 - a. Heater is securely mounted and clearances from combustible materials have been observed (see Clearances – page 7);
 - b. Tip angle of heater does not exceed 30 degrees (see Correct Mounting – page 12);
 - c. Gas line is properly connected and there are no leaks (see Gas Piping – page 8);
 - d. Power adapter (7.5 VDC) is connected to a live power outlet and connected properly to the heater (see Electrical – page 8 and Basic Wiring – page 10)
2. Start Heater;
 - a. Turn ON manual gas valve..
 - b. Gently press the ON button of the remote control for 1 second;
 - c. Allow heater 5 minutes to fully warm up. (in full daylight it may be difficult to see the flame);
 - d. If heater locks out, press the OFF Button to RESET Heater and repeat start up sequence.
 - e. If the heater locks out several times there may still be air in the gas line.

NOTE: Some white smoke may appear during or just after the initial start-up of the heater. White smoke will dissipate with proceeding use. This is normal due to some residual lubrication on a new heater

Regular Service and Maintenance

Over time, particularly during long periods of non-use, the heater can accumulate dirt and debris in and around the pilot and the burner. Routine maintenance should be performed at least once a year by a qualified service agency to insure the heater is operating properly. More frequent service may be required for heaters located near waterfronts. If local service is not available call your natural gas or propane supplier.

Battery Life

Both the wall control and handheld remotes use batteries available at the local hardware store. Please keep in mind the following:

- Weak batteries can reduce the range of the transmitter.
- Batteries should be removed if heaters are not to be used for a long period of time.
- Dispose of used batteries properly.
- Replace batteries annually or as needed.

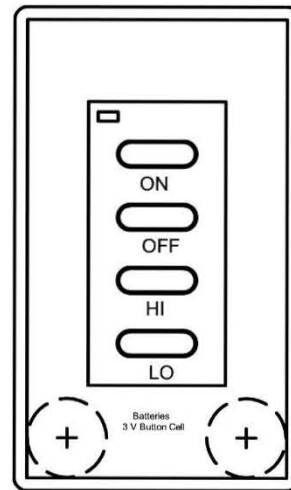

Two #2032 Button Batteries power the wall control transmitter They are available at your local hardware store.

Loss of Programming

Although each heater comes pre-programmed for two devices, this programming can be lost if the following occurs:

- Electrical Power Surge
- Heater is disconnected a long period of time.
- More than three devices have been programmed for the heater.

SUNPAK® S34-TSR INFRARED HEATERS

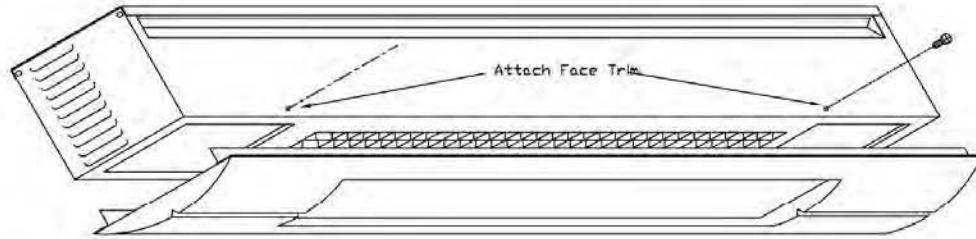

Optional Face Trim can be easily installed on all Sunpak models.

You must remove the Sunpak Face Trim to connect power to the heater. The Sunpak Face Trim is secured with four (4) screws, two (2) located along each side of the heater.

SUNPAK S34-TSR Wiring for Multiple Heaters

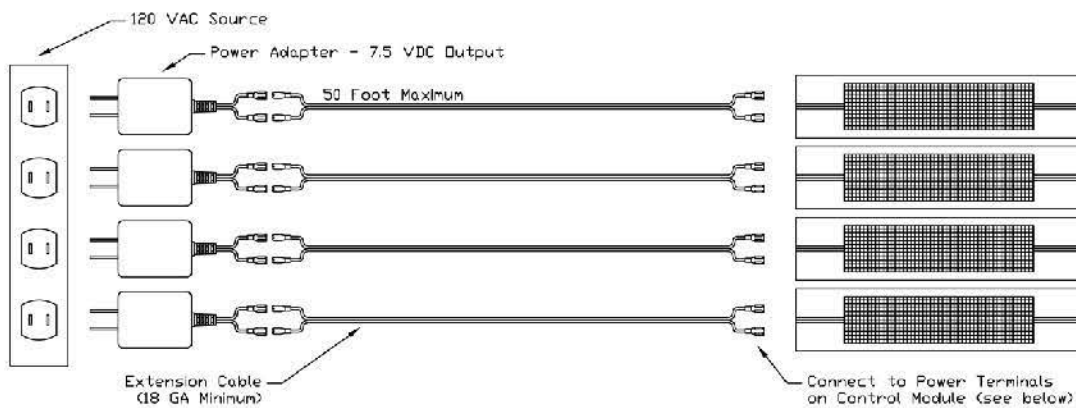

Basic Wiring

Sunpak S34-TSR requires 7.5 VDC for its controls. In most cases you will be running low voltage wire from the Power Adapter plugged into a 120 VAC outlet. The Power Adapter is **not** water proof and must be weather protected. The extension wire can be run 50 feet with 18 GA and must have suitable outdoor insulation. In order to add the extension wire you must:

1. Remove the Face Trim
2. Disconnect the Power Adapter from the control module.
3. Attach the slide connector to the extension wire.
4. Connect one end of the extension wire cable to the module and the other end to the Power Adapter

WARNING: Do not attach the Extension Cable directly to the 120 VAC Outlet.

NOTE: Male and Female connections are supplied in the extension kit supplied with each heater

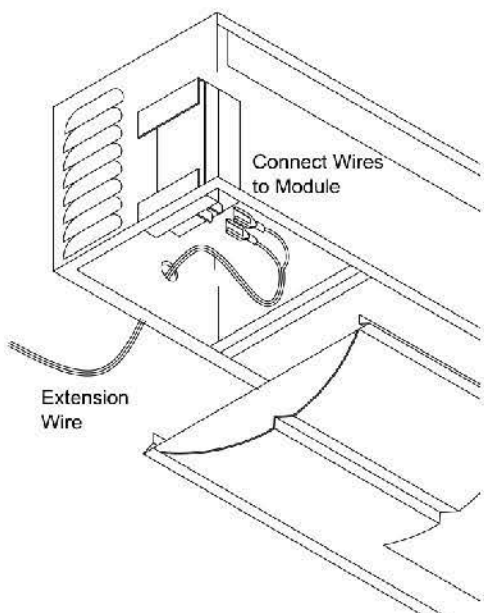

SUNPAK® S34-TSR INFRARED HEATERS

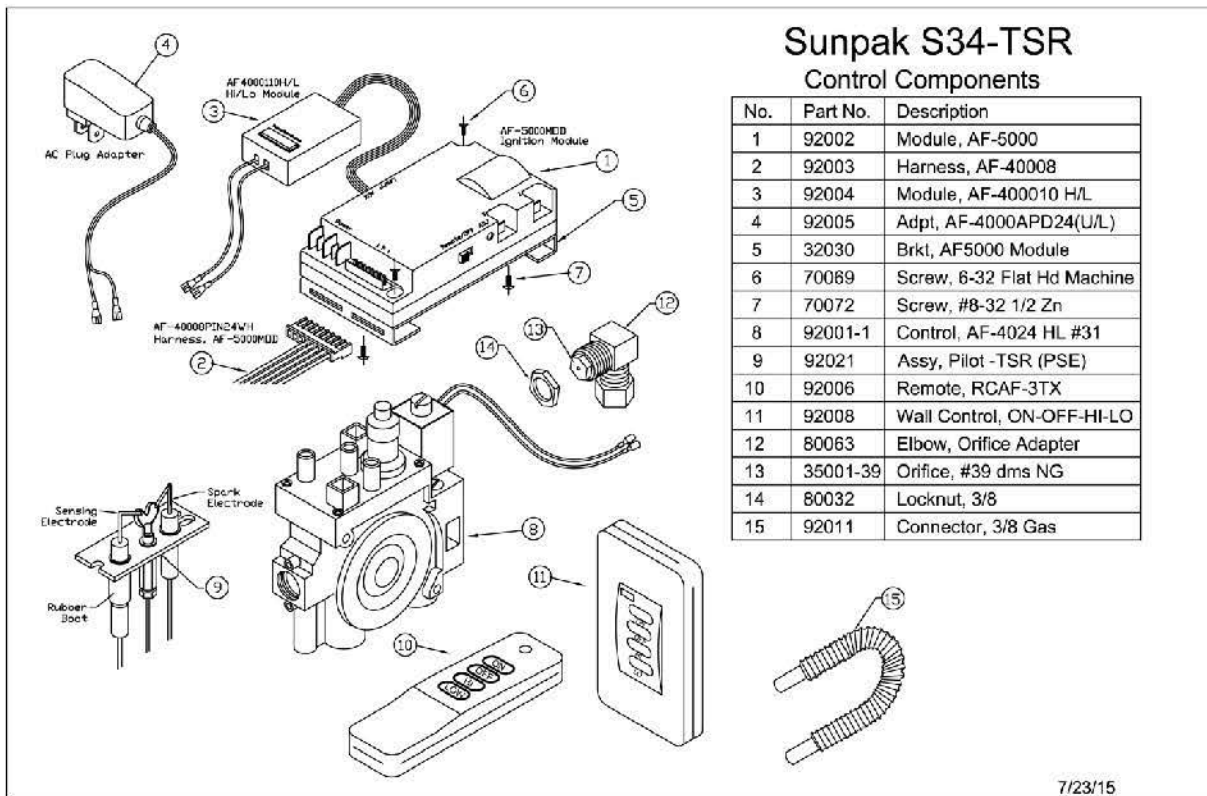
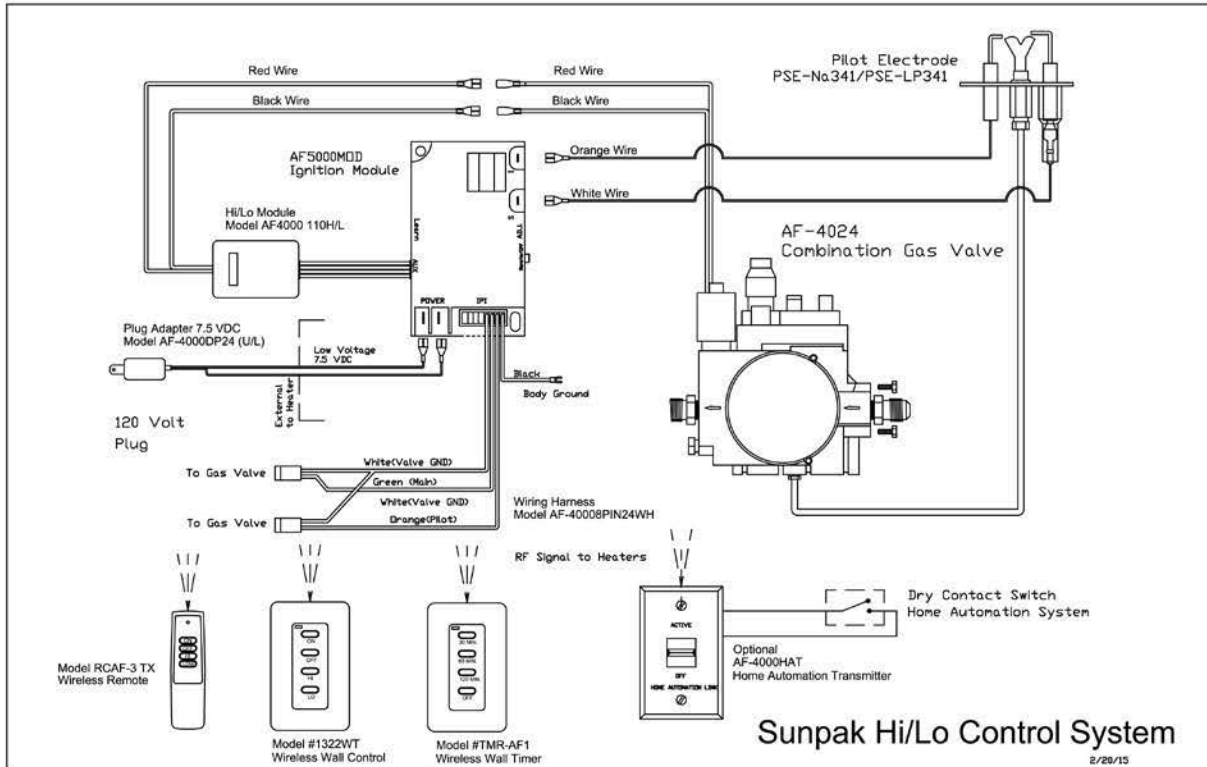

SUNPAK® S34-TSR INFRARED HEATERS

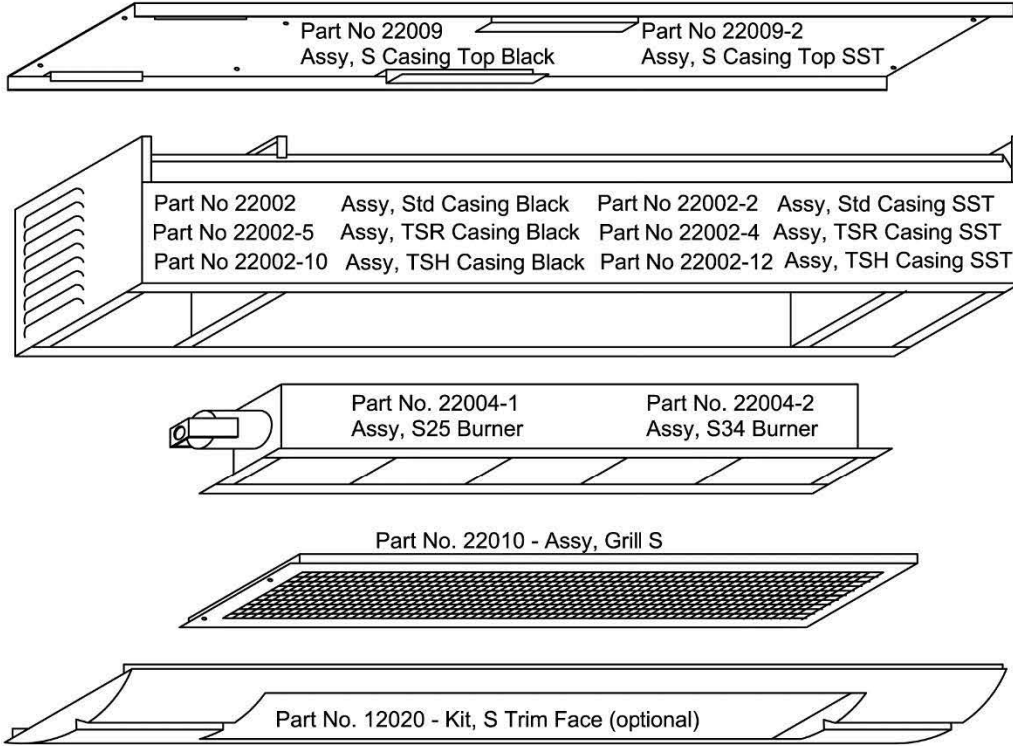

Sunpak Heater must be mounted correctly (Control End View)

Angle Mounted

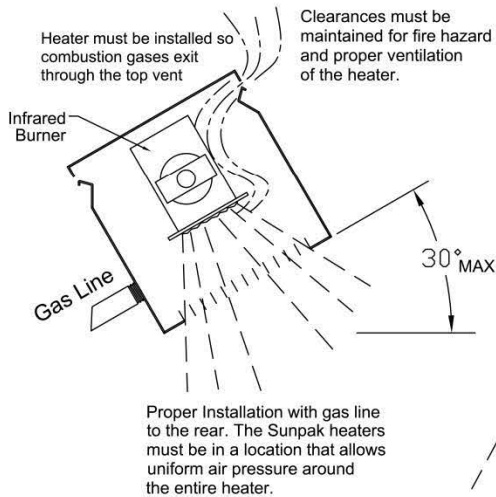

Horizontal Mounted

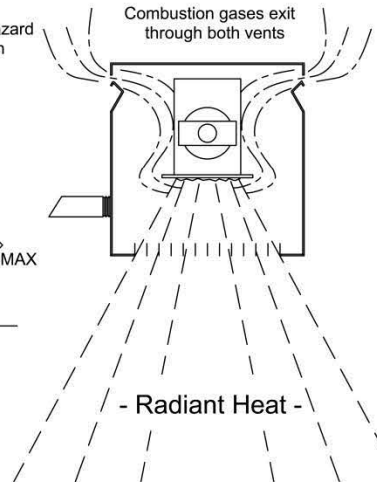

Incorrect Mounting will cause damage to heater

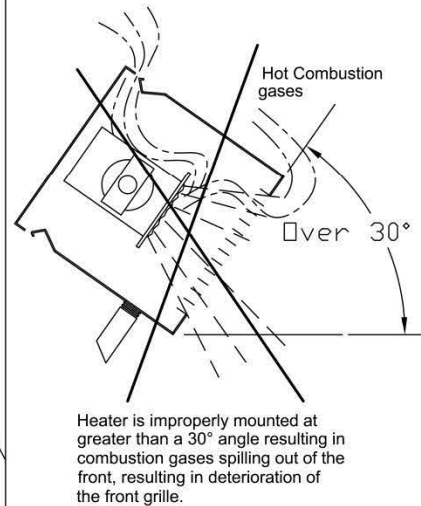

Basic TSR Trouble Shooting

Problem	Possible Causes	How to Fix	References
No Spark to pilot	No red indicator light on remote control device	<ul style="list-style-type: none"> Replace batteries in remote control device Replace remote control device 	Basic Operation - Page 3 Battery Life - Page 9
	No power to the heater	<ul style="list-style-type: none"> Verify power adapter is plugged into a live 120 VAC outlet Verify wiring is properly connected to the heater module 	Electrical – Page 8 Basic Wiring – Page 10
	Remote control does not communicate with the heater	<ul style="list-style-type: none"> Make sure remote control is within 25 feet of the heater Make sure ID Number on remote corresponds to number on heater. (Heater comes with two (2) pre-programmed remote control devices – try second remote). Heaters must be re-programmed for any replacement remote control devices 	Wireless Remote – Page 15 Basic Operation – Page 3 Programming new remote control device – Page 14
Sparks, but does not ignite burner	No Gas to Heater	<ul style="list-style-type: none"> Allow time for air to bleed from gas line on new installations Turn on manual gas valve Check wire connections on top of gas valve. Clean burner orifice 	Gas Piping – Page 8 Regular Service & Maintenance – Page 9
Heater lights, but turns off	Low Voltage	<ul style="list-style-type: none"> Make sure you have 6-8 VDC to heater 	
	Loose or broken ground wire	<ul style="list-style-type: none"> Secure ground wire to heater body 	Control System – Page 11
	Pilot Electrode	<ul style="list-style-type: none"> Adjust pilot electrodes 3/16 from pilot hood and 3/8 apart. Swap sensor and spark connections on module Replace TSR Control Module Replace Pilot Electrode Assembly 	Sunpak Pilot – Page 15 Control Components – Page 11
Not Enough Heat	Low Gas Pressure	<ul style="list-style-type: none"> Verify required gas pressure to heater 	Gas Supply – Page 7 Gas Piping – Page 8
	Lack of Fresh Air to Heater	<ul style="list-style-type: none"> Adjust tip angle to less than 30 degrees Add ventilation to patio above and below heater 	Ventilation – Page 9
	Dirty Orifice	<ul style="list-style-type: none"> Clean orifice 	Regular Service & Maintenance – Page 9.
	Poor Heater Coverage	<ul style="list-style-type: none"> Review Heater Layout and Design 	Heater Layout & Design – Page 4
Deterioration of Front Grill	Tip Angle over 30 degrees	<ul style="list-style-type: none"> Adjust Tip Angle to less than 30 Degrees 	Incorrect Mounting – Page 12
	Wind hitting heater from below	<ul style="list-style-type: none"> Set up wind break to prevent strong breeze from hitting infrared burner face directly. Any wind break must not interfere with the safe operation of the heater 	Heater Layout & Design – Page 4
Burner Noise	Dirty Orifice	<ul style="list-style-type: none"> Clean orifice thoroughly or replace if necessary 	Regular Service & Maintenance – Page 9
	Dirty Burner	<ul style="list-style-type: none"> Use bottle brush to clean mixer tube of burner Use compressed air to clean ceramic burner ports (max 30 PSI - use safety glasses) 	
	Cracked Ceramics	<ul style="list-style-type: none"> Replace infrared burner 	

Trouble Shooting Remote Controls

Error Code:	Reason	Solution
Module has four “beeps” every one second	Warns user that the pilot flame sensor detects a pilot flame already present when ignition sequence is initiated. This fault will also occur if pilot flame sensor on main control module is shorted to ground	Adjust the sensor electrode to 3/16” for the pilot hood and 3/8” from the spark electrode. Make sure the electrode is within the flame zone.
Four beeps every two seconds	Warns users the module’s internal temperature has exceeded 170° F. (77° C.)	Correct Mounting Angle – Page 4 Provide Proper Ventilation – Page 9 Allow heater to cool down before pressing <Off> then <ON>
One beep every four seconds	Flame Safety Circuit has locked out	Press OFF button to reset then ON to restart heater

Each Sunpak TSR comes with wireless controls pre-programmed for individual heaters. If you have a problem with the remotes, please review the following:

1. Make sure there is power to the unit through the 7.5 VDC plug-in power adapter.
2. Make sure you have the correct control for the heater. Each control is marked with a number corresponding to the label located on the lower end of the heater.
3. Make sure you gently press the <ON> button for 1 full second to allow the control to respond.
4. Make sure the red indicator lights up while pressing the <ON> button. Replace batteries if necessary.
5. Each heater comes with two wireless control devices. Try the other control device.
6. Press <OFF> to RESET system and then press <ON>. After a few seconds you should hear an audible click from the control inside the heater and see a spark at the pilot behind the face grille.

If the above procedure fails to get results it may be necessary to re-program the heater control. The diagram on page 3 of these instructions shows the location of the programming button inside the heater. This button may be accessed through the port on the front panel of the heater. A small rod such as a bent heavy duty paper clip or 1/8 inch pin will be necessary to reach the button.

The heater control communicates using a series of beeps. In a noisy environment these beeps may be hard to hear. Though these beeps are helpful they are not necessary for programming the heater.

Programming Remote Control Devices

1. Select the wireless device you want the use with the heater.
2. Locate the learn button of the heater control as shown in the diagram on page 3. With the bent paper clip, press and hold the learn button for 6 seconds before releasing.

SUNPAK® S34-TSR INFRARED HEATERS

3. Press and release the learn button on the heater control. Press the <ON> button on the wireless device within 10 seconds. Make sure the remote's red indicator light went on while pressing the remote.
4. The heater should now recognize the wireless device.
 - a. Press the <OFF> button on the wireless device
 - b. Press the <ON> button
 - c. Press the <HI> button
 - d. Leave heater on HI for first 5 minutes

If the heater does not light, repeat procedure 4. It is likely that there is still air in the gas line. If the heater fails to light or fails to stay lit after several tries, it may be necessary to purge the air from the gas line using safe practices.

NOTE: Only 3 remote controls can be programmed into the heater at one time. It may necessary to clear the memory if a new device does not program properly. To clear the memory, hold the learn button in for over 10 seconds. A series of beeps will indicate memory is cleared.

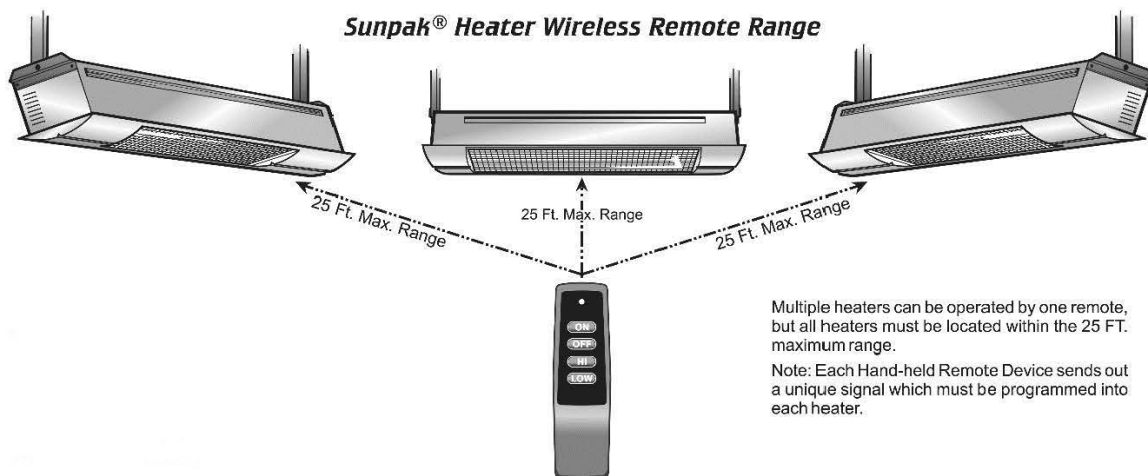
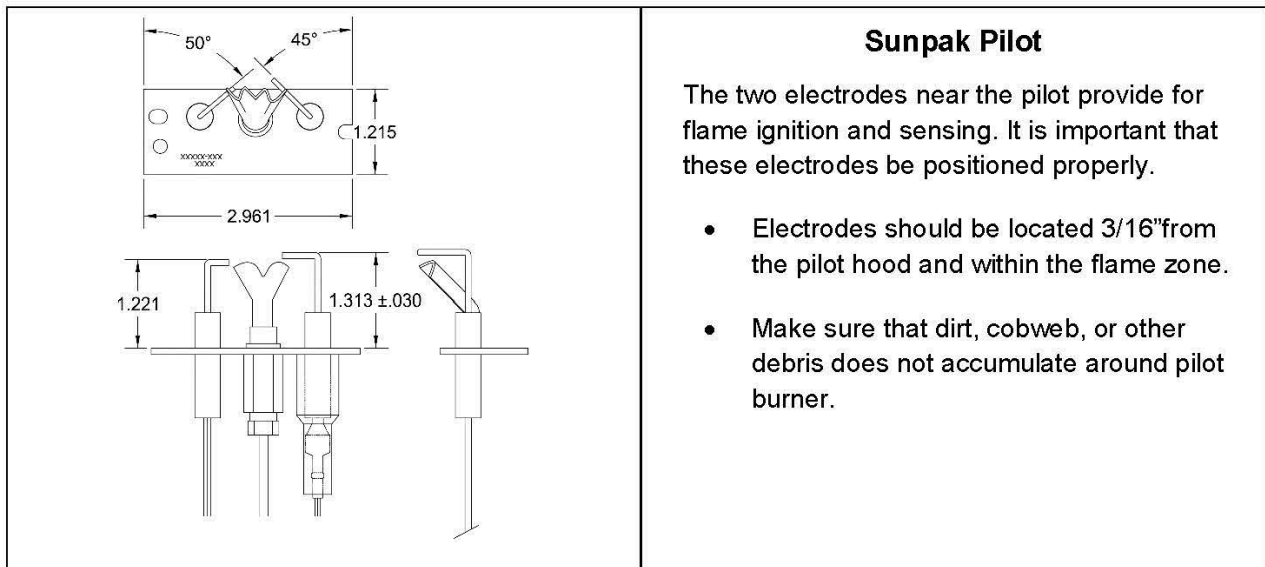

Limited Warranty

THIS WARRANTY IS APPLICABLE TO THE ORIGINAL OWNER ONLY, in accordance with the warranty terms and conditions specified below.

Infrared Dynamics (the warrantor) will furnish at our option the ORIGINAL OWNER, 1) a replacement Infrared Dynamics' heater or 2) a replacement part for any component part which fails before one year when used for residential use. When the heater has been used for other than single family residential application the warranty shall be 90 days.

Service and Labor Responsibility

UNDER THIS LIMITED WARRANTY, THE WARRANTOR WILL PROVIDE ONLY A REPLACEMENT HEATER OR PART THEREOF. THE OWNER IS RESPONSIBLE FOR ALL OTHER COSTS. Such costs may include, but are not limited to:

- a. Labor charges for service, removal, or reinstallation of the heater or part thereof.
- b. Shipping and delivery charges for forwarding the new heater or replacement part from the nearest distributor and returning the claimed defective heater or part to such distributor.
- c. All costs necessary or incidental for handling and administrative charges and for any materials and/or permits required for installation of the replacement heater or part.

LIMITATION ON IMPLIED WARRANTIES

Implied warranties, including any warranty of merchantability imposed on the sale of this heater under state law are limited to one year duration for the heater or any of its parts. Some states do not allow limitations on how long an implied warranty lasts, so the above limitations may not apply to you.

CLAIMS PROCEDURE

Any claim under this warranty should be initiated with the distributor, dealer, or seller who sold the heater, or with any other dealer handling the warrantor's products. If this is not practical, the owner should contact: Infrared Dynamics, 3830 Prospect Avenue, Yorba Linda, California 92886. Phone 1-888-317-5255 or visit our website: www.infradyne.com.