



**Model F231**  
**OPERATORS MANUAL**  
Manual No. [513658](#) Rev.8



This manual provides basic information about the machine. Instructions and suggestions are given covering its operation and care. This manual follows the guidance set forth in the following industry standards: ANSI Z535.6, ASTM F760-93, ASTM F1827-13, FDA Food Code.

The illustrations and specifications in this manual are not binding in detail. We reserve the right to make changes to the machine without notice, and without incurring any obligation to modify or provide new parts for machines built prior to date of change.

**DO NOT ATTEMPT** to operate the machine until instructions and safety precautions in this manual are read completely and are thoroughly understood. If problems develop or questions arise in connection with installation, operation, or servicing of the machine, contact Stoelting White Glove Service.



[stoeltingfoodservice.com](http://stoeltingfoodservice.com)

Stoelting Foodservice Equipment  
502 Highway 67  
Kiel, WI 53042-1600  
U.S.A.

White Glove Service Network  
Phone: 888.319.9549

© 2019 Stoelting

---

## ***A Few Words About Safety***

### **Safety Information**

**Read and understand the entire manual before operating or maintaining Stoelting equipment.**

This manual provides the operator with information for the safe operation and maintenance of Stoelting equipment. As with any machine, there are hazards associated with their operation. For this reason safety is emphasized throughout the manual. To highlight specific safety information, the following safety definitions are provided to assist the reader.

The purpose of safety symbols is to attract your attention to possible dangers. The safety symbols, and their explanations, deserve your careful attention and understanding. The safety warnings do not by themselves eliminate any danger. The instructions or warnings they give are not substitutes for proper accident prevention measures.

If you need to replace a part, use genuine Stoelting parts with the correct part number or an equivalent part. We strongly recommend that you do not use replacement parts of inferior quality.



### **Safety Alert Symbol:**

**This symbol** Indicates danger, warning or caution. Attention is required in order to avoid serious personal injury. The message that follows the symbol contains important information about safety.

### **Signal Word:**

Signal words are distinctive words used throughout this manual that alert the reader to the existence and relative degree of a hazard.



The signal word “WARNING” indicates a potentially hazardous situation, which, if not avoided, may result in death or serious injury.



The signal word “CAUTION” indicates a potentially hazardous situation, which, if not avoided, may result in minor or moderate injury.

### ***NOTICE***

The signal word “*NOTICE*” indicates information relating to equipment/property damage. The information is not hazard-related.

### **NOTE**

The signal word “NOTE” indicates additional information relating to the subject, usually a hint or tip, that is not hazard-related and does not involve equipment/property damage.

# TABLE OF CONTENTS

<b>Section</b>	<b>Description</b>	<b>Page</b>
<b>1</b>	<b>Description and Specifications</b>	
1.1	Description.....	1
1.2	Specifications .....	1
<b>2</b>	<b>Installation Instructions</b>	
2.1	Safety Precautions .....	3
2.2	Shipment and Transit.....	3
2.3	Machine Installation.....	3
2.4	IntelliTec2™ Setup.....	4
<b>3</b>	<b>Initial Set-Up and Operation</b>	
3.1	Operator's Safety Precautions .....	7
3.2	Operating Controls and Indicators.....	7
3.3	Emptying the Freezing Cylinder .....	8
3.4	Disassembly of Machine Parts .....	8
3.6	Cleaning Disassembled Parts .....	9
3.6	Cleaning the Machine.....	9
3.7	Assembling Machine .....	10
3.8	Sanitizing .....	10
3.9	Freeze Down and Operation .....	11
3.10	Mix Information .....	12
<b>4</b>	<b>Maintenance and Adjustments</b>	
4.1	Fine Consistency Adjustment .....	13
4.2	Drive Belt Tension Adjustment.....	13
4.3	Condenser Cleaning (Air-Cooled Machines).....	13
4.4	Preventative Maintenance .....	13
4.5	Extended Storage.....	14
<b>5</b>	<b>Troubleshooting</b>	
5.1	Error Codes .....	15
5.2	Troubleshooting - Error Codes .....	15
5.3	Troubleshooting - Machine .....	17
<b>6</b>	<b>Replacement Parts</b>	
6.1	Decals and Lubrication .....	19
6.2	Auger Shaft and Faceplate Parts .....	20
6.3	Hopper Parts .....	21



# SECTION 1 INTRODUCTION

## 1.1 DESCRIPTION

The Stoelting F231 floor machine is gravity fed. The machine is equipped with the IntelliTec2 control which provides a uniform product. The F231 is designed to operate with almost any type of commercial soft serve or non-dairy mixes available, including: ice milk, ice cream, yogurt, and frozen dietary desserts.

This manual is designed to assist qualified service personnel and operators in the installation, operation and maintenance of the Stoelting F231 gravity machine.



Figure 1-1 Model F231

## 1.2 SPECIFICATIONS



Figure 1-2 Specification

## 1.2 SPECIFICATIONS

		<b>Model F231</b>	
<b>Dimensions</b>	<b>Machine</b>	<b>as shipped</b>	
width	19-1/4" (48,9 cm)	32" (81,3 cm)	
height	58-1/4" (148,0 cm)	60" (152,4 cm)	
depth	A/C: 31-3/8" (79,7 cm), W/C: 28" (71,1 cm)		39" (99,1 cm)
<b>Weight</b>	400 lbs (181,4 kg)		470 lbs (213,1 kg)
<b>Electrical</b>	<b>1 Phase, 208-240 VAC, 60Hz</b>		<b>3 Phase, 208-240 VAC, 60Hz</b>
running amps	12A		10A
connection type	NEMA 6-20P power cord provided		NEMA L15-20P power cord provided
International Option	1 Phase, 220-240 VAC, 50Hz & 3 Phase, 380-415 VAC, 50Hz		
<b>Compressor</b>	12,000 Btu/hr		
<b>Drive Motor</b>	Two - 3/4 hp		
<b>Air Flow</b>	Air cooled units require 3" (7,6 cm) air space on the right side		
<b>Plumbing Fittings</b>	Water cooled units require 1/2" N.P.T. water and drain fittings. Maximum water pressure of 130 psi. Minimum water flow rate of 3 GPM. Ideal EWT of 50°-70°F		
<b>Hopper Volume</b>	Two - 3 gallon (11,35 liters)		
<b>Freezing Cylinder Volume</b>	Two - 0.85 gallon (3,22 liters)		

## SECTION 2 INSTALLATION INSTRUCTIONS

### 2.1 SAFETY PRECAUTIONS

Do not attempt to operate the machine until the safety precautions and operating instructions in this manual are read completely and are thoroughly understood.

Take notice of all warning labels on the machine. The labels have been put there to help maintain a safe working environment. The labels have been designed to withstand washing and cleaning. All labels must remain legible for the life of the machine. Labels should be checked periodically to be sure they can be recognized as warning labels.

If danger, warning or caution labels are needed, indicate the part number, type of label, location of label, and quantity required along with your address and mail to:

**STOELTING**  
**ATTENTION: Customer Service**  
**502 Hwy. 67**  
**Kiel, Wisconsin 53042**

### 2.2 SHIPMENT AND TRANSIT

The machine has been assembled, operated and inspected at the factory. Upon arrival at the final destination, the entire machine must be checked for any damage which may have occurred during transit.

With the method of packaging used, the machine should arrive in excellent condition. THE CARRIER IS RESPONSIBLE FOR ALL DAMAGE IN TRANSIT, WHETHER VISIBLE OR CONCEALED. Do not pay the freight bill until the machine has been checked for damage. Have the carrier note any visible damage on the freight bill. If concealed damage and/or shortage is found later, advise the carrier within 10 days and request inspection. The customer must place claim for damages and/or shortages in shipment with the carrier. Stoelting, Inc. cannot make any claims against the carrier.

### 2.3 MACHINE INSTALLATION



**Installation must be completed by a qualified electrician/refrigeration specialist.**

Incorrect installation may cause personal injury, severe damage to the machine and will void factory warranty.

Installation of the machine involves moving the machine close to its permanent location, removing all crating, setting in place, assembling parts, and cleaning.

### PRIOR TO INSTALLATION

- A. Locate a copy of the service contact file (info.txt).
- B. Modify the info.txt file with information from the service company using the instructions in the file.
- C. Put the service contact file onto the root level of a USB flash drive (do not put the files into any folder).

### INSTALLATION

- A. Uncrate the machine.
- B. Install the four casters. Turn the threaded end into the machine until no threads are showing. To level, turn out casters no more than 1/4" maximum, then tighten all jam nuts.
- C. The machine must be placed in a solid level position.

### NOTE

*Accurate leveling is necessary for correct drainage of freezing cylinder and to ensure correct overrun.*

- D. Machines with air cooled condensers require a minimum of 3" (7,5cm) of space on both sides for proper circulation.
- E. Machines that have a water cooled condenser require 1/2" NPT supply and drain fittings.

### INSTALLING PERMANENT WIRING

- A. Refer to the nameplate on the side panel of the machine for specific electrical requirements. Make sure the power source in the building matches the nameplate requirements.
- B. Remove the back panel and the junction box cover located at the bottom of the machine.
- C. Install permanent wiring according to local code.

## 2.4 INTELLITEC2™ SETUP

- A. Disassemble, clean, lubricate and assemble the machine following the steps in Section 3.
- B. Fill the hoppers with sanitizer.
- C. Connect power to the machine and press the Main Power On/Off button.

### MOTOR CALIBRATION

Before starting the motor calibration, be sure there is sanitizer in the freezing cylinder.

- A. Press the On/Off Left or On/Off Right button. The Motor Calibration screen will be displayed.

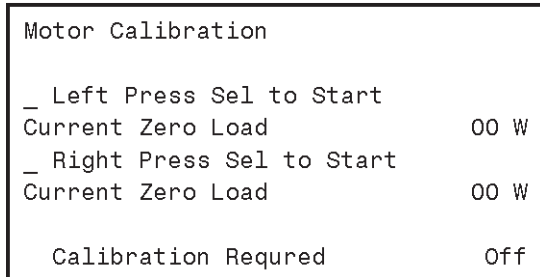

**Figure 2-1**

- B. Move the cursor over the Left side and press the SEL button then move the cursor over the Right side and press the SEL button.

#### NOTE

*The motor calibration can be done for both sides simultaneously.*

- C. After the calibration is complete, press the left arrow button.
- D. Drain the machine of sanitizer.

### SETTING CONTACT INFORMATION (OPTIONAL)

- A. Plug your USB flash drive into the control if it is not already plugged in.
- B. From the Current Status screen, press the left arrow button to access the passcode selection screen. Press the right arrow, SET, and then the SEL button.

- C. After the password is accepted, use the arrows to move the cursor to the Modify Settings option and press the SEL button. Then move the cursor to the User Preferences and press the SEL button.

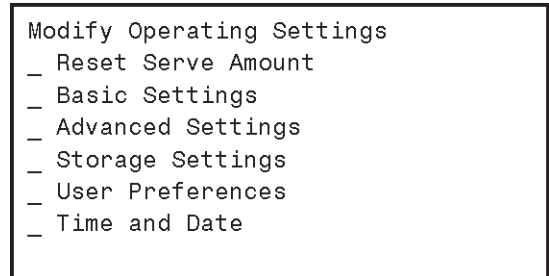

**Figure 2-2**

- D. On the User Preferences screen move the cursor to the Contact Information USB Update and press the SEL button.

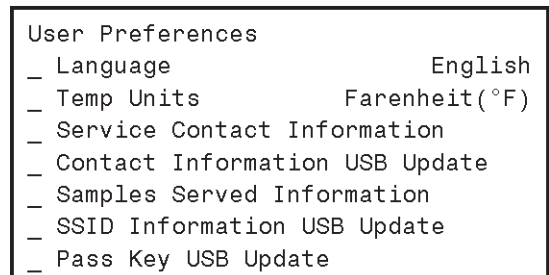

**Figure 2-3**

- E. The screen will change and show "File Found" for a quick second while it updates the information.
- F. After updating the contact information, the screen will show the Service Contact Information page.

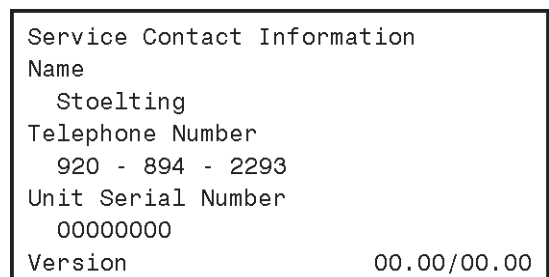
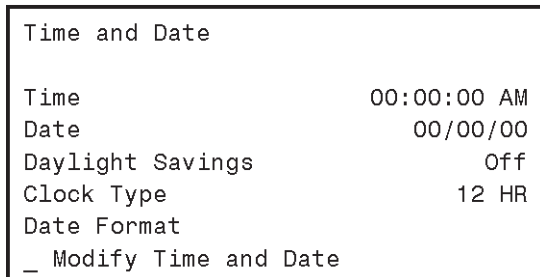

**Figure 2-4**

- G. Press the left arrow button to go back to the Current Status screen and remove the USB flash drive.

## SETTING TIME AND DATE

- A. Press the right arrow button.
- B. Move the cursor to the Modify Settings option and press the SEL button. Then move the cursor to the Time and Date option and press the SEL button and adjust the settings as required.
  1. Press the SEL button to enter the Modify Time and Date screen.
  2. Move the cursor to the setting that needs to be changed and press the SET button.
  3. Use the arrow buttons to change the setting and press the SET button to save the change.



**Figure 2-5**

- C. Press the left arrow button until the Current Status screen is displayed.

## SETTING CONSISTENCY

- A. Install the mix inlet regulator.
- B. Fill the hopper with liquid mix.
- C. Press the Push to Freeze button and let the machine cycle 1-2 times.
- D. Draw product from the barrel immediately after the compressor cycles off after the fifth time and test the product for consistency and temperature.
- E. Adjust the product consistency by increasing or decreasing the Consist Offset settings. These settings are under the Modify Settings - Basic Settings menu
- F. Adjust the settings as follows:
  1. If the product is too soft, increase the CutIn Consist Offset.
  2. If the product is too firm, decrease the CutIn Consist Offset.
- F. After the consistency is set, press the left arrow button once so that the Modify Operating Settings screen is displayed.

## SETTING SERVE TIME AND OVERRUN DETAILS

- A. Go to the Advanced Settings (2 of 2) screen and scroll down to the Time to Dispense 16 oz option.
- B. Time how long it takes to dispense 16 oz of product into a cup and change the value in the control.
- C. Measure to overrun of the product and change the value in the control. To measure overrun, do the following:
  1. Zero a scale with an 8 - 16 oz cup.
  2. Fill the cup with liquid mix and weigh it. Make sure the mix is filled to the rim.
  3. Fill the cup with frozen product. Make sure there are no voids (air pockets) when filling.
  4. Scrape the top of the cup with a straight edge.
  5. Weigh the filled cup.
  6. Calculate the overrun using the following equation:
$$\frac{\text{Liquid Weight} - \text{Frozen Weight}}{\text{Frozen Weight}} \times 100 = \% \text{ Overrun}$$
- D. Change the value in the control.
- E. Press the left arrow button until the Current Status screen is displayed.

## SETTING DISCHARGE PRESSURE ON WATER COOLED MACHINES

- A. Water cooled machines require the water condenser valves to be adjusted to maintain a 225-235 psig discharge pressure.

When adjusting the discharge pressure the machine must be under a full load with both cylinders and the hopper running.



## SECTION 3 INITIAL SET-UP AND OPERATION

### 3.1 OPERATOR'S SAFETY PRECAUTIONS

SAFE OPERATION IS NO ACCIDENT; observe these rules:

- A. Know the machine. Read and understand the Operating Instructions.
- B. Notice all warning labels on the machine.
- C. Wear proper clothing. Avoid loose fitting garments, and remove watches, rings or jewelry that could cause a serious accident.
- D. Maintain a clean work area. Avoid accidents by cleaning up the area and keeping it clean.
- E. Stay alert at all times. Know which switch, push button or control you are about to use and what effect it is going to have.
- F. Disconnect power for maintenance. Never attempt to repair or perform maintenance on the machine until the main electrical power has been disconnected.
- G. Do not operate under unsafe operating conditions. Never operate the machine if unusual or excessive noise or vibration occurs.

### 3.2 OPERATING CONTROLS AND INDICATORS

Before operating the machine, it is required that the operator know the function of each operating control. Refer to Figure 3-1 for the location of the operating controls on the machine. For the information regarding error codes displayed on the control panel, refer to the troubleshooting section of this manual.

#### WARNING

High voltage will shock, burn or cause death. The OFF-ON switch must be placed in the OFF position prior to disassembling for cleaning or servicing. Do not operate machine with panels removed.

#### A. INTELLITEC2 TOUCHPAD

##### Main Power On/Off

The Main Power button is used to supply power to the IntelliTec2™ control, the freezing cylinder circuits and the storage refrigeration system. When the machine is first plugged in, the control defaults to the On status with power to the hopper only. If the Main Power On/Off button is pressed when the machine is on, the machine turns off and a status message displays on the screen.



Figure 3-1 Machine Controls

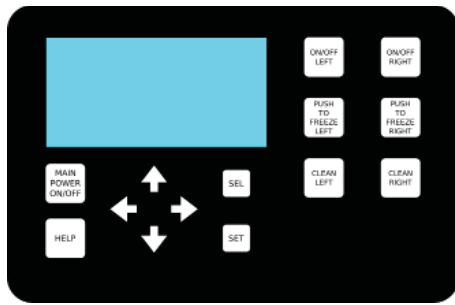

**Figure 3-2 IntelliTec2 Control**

### Help

Pressing the Help button displays help information dependent on the cursor's location. Pressing the Help button again exits the help screen.

### Selection Button (SEL)

The SEL button is used by technicians to select menu options.

### Set Button (SET)

The SET button is used by technicians to save changes when modifying control settings.

### On/Off Button

Power to the freezing cylinders is controlled with the On/Off Left and On/Off Right switches.

### Push to Freeze Button

Pressing the PUSH TO FREEZE button initiates "Serve Mode".

### Clean Button

The CLEAN button initiates "Clean Mode".

### Arrow Buttons (←, ↑, →, ↓)

The arrow buttons are used by technicians to navigate through the control readings and settings.

## B. DISPENSE RATE ADJUSTOR

The dispense rate adjustor is located under the header panel, to the immediate right of the spigot handles. Turning the knob counterclockwise decreases the dispense rate.

## C. USB ACCESS PORT

The USB access port is located on the right side panel of the machine. The port is used by technicians to import firmware and export machine statistics.

## 3.3 EMPTYING THE FREEZING CYLINDER

If the machine is empty, go to Section 3.4.

- A. Make sure the Main Freezer Power is on. If the IntelliTec2™ displays the Current Status Screen, then the main power is on.
- B. Turn off the freezing cylinders by pressing the On/Off buttons.
- C. Remove the hopper covers and remove the mix inlet regulators from the hoppers.
- D. Press the Clean buttons. After about 5 minutes open the spigots to drain the mix.
- E. Press the Clean buttons to stop the auger.
- F. Fill each hopper with 2 gallons (8 liters) of cool tap water. Optional: Use detergent solution instead of tap water to make cleaning the parts easier after disassembly.
- G. Press the Clean buttons and let the augers rotate for at least 30 seconds.
- H. While the augers are rotating, scrub the hoppers with a clean brush.
- I. Drain the water out of the machine.
- J. Press the Clean buttons to stop the augers.

### NOTE

*If the water does not drain clear, repeat steps F through J.*

## 3.4 DISASSEMBLY OF MACHINE PARTS

Before using the machine for the first time, complete machine disassembly, cleaning, and sanitizing procedures need to be followed. Routine cleaning intervals and procedures must comply with the local and state health regulations. Inspection for worn or broken parts should be made at every disassembly of the machine. All worn or broken parts should be replaced to ensure safety to both the operator and the customer and to maintain good machine performance and a quality product. Check the wear line on the auger flights on a regular basis (Fig. 3-3) and replace as needed.



**Figure 3-3 Auger Flight Wear**

To disassemble the machine, refer to the following steps:

#### NOTE

*The hopper covers have compartments for all freezing cylinder parts. The covers help with parts identification and prevent loss of parts. After disassembly, place the freezing cylinder parts in the hopper covers to transport them to and from the washing station.*

#### A. DISASSEMBLY OF FRONT DOOR

1. Press and hold the Main Freezer Power button for three seconds to turn the power off.
2. Remove the rosette caps or spigot extensions if installed.
3. Remove the knobs on the front door.
4. Remove the front door by pulling it off the studs.
5. Remove the spigot through the bottom of the front door.
6. Remove all o-rings from parts by first wiping off the lubricant using a clean towel. Then squeeze the o-ring upward to form a loop (Fig. 3-4). Roll the o-ring out of the groove.



Figure 3-4 Removing O-Ring

#### B. DISASSEMBLY OF AUGER

1. Remove the front auger supports and bushings.
2. Remove the auger assemblies from the machine. Pull the augers out of the freezing cylinders slowly. As the augers are being pulled out, carefully remove each of the plastic flights with springs.
3. Keep the rear of the augers tipped up once they are clear of the freezing cylinders to prevent the rear seal assemblies from dropping.
4. Wipe the lubricant off of the hex ends of the augers with a paper towel. Remove the rear seal assemblies (Fig. 3-5).
5. Unscrew the springs from the auger flights.



Figure 3-5 Rear Seal Assembly

#### 3.5 CLEANING DISASSEMBLED PARTS

Disassembled parts require complete cleaning, sanitizing and air drying before assembling. Local and state health codes dictate the procedure required. Some state health codes require a four sink process (pre-wash, wash, rinse, sanitize, air dry), while others require a three sink process (without the pre-wash step). The following procedures are a general guideline only. Consult your local and state health codes for the procedures required in your location.

- A. Disassemble all parts. (Refer to Section 3.4 for the disassembly of machine parts)
- B. Place all parts in 90° to 110°F (32°C to 43°C) mild detergent water and wash thoroughly. Use the brushes that shipped with the machine to clean all holes in the front door, flights, mix pickup assembly, etc.
- C. Rinse all parts with clean 90° to 110°F (32°C to 43°C) water.
- D. Place all parts in a sanitizing solution for at least 1 minute, then remove and let air dry completely before assembling in machine.

#### 3.6 CLEANING THE MACHINE

##### INTERIOR CLEANING

- A. Using detergent solution and the large barrel brush provided, clean the hoppers and freezing cylinders.

#### NOTE

*Make sure to thoroughly clean the rear seal surfaces on the inside of the freezing cylinders.*

- B. Wrap the brush in a clean cloth and thoroughly dry the hoppers and freezing cylinders.
- C. Remove the drip tray and drain trays. Clean and replace the trays.

## EXTERIOR CLEANING

The exterior should be kept clean at all times to preserve the luster of the stainless steel. A high grade of stainless steel has been used on the machine to ease cleanup. To remove spilled or dried mix, wash the exterior with 90° to 110°F (32°C to 43°C) mild detergent water and wipe dry.

Do not use highly abrasive materials, as they will mar the finish. Use a soft cloth or sponge to apply the solution. For best results, wipe with the grain of the steel.

### 3.7 ASSEMBLING MACHINE

To assemble the machine parts, refer to the following steps:

#### NOTICE

*Total Blend sanitary lubricant, Petrol-Gel sanitary lubricant, or equivalent must be used when lubrication of machine parts is specified.*

*Total Blend can be used in place of two products. It is used to lubricate parts and also used in place of spline lubricant. Do not use more than one packet of Total Blend per freezing cylinder.*

#### NOTICE

*The United States Department of Agriculture and the Food and Drug Administration require that lubricants used on food processing equipment be certified for this use. Use lubricants only in accordance with the manufacturer's instructions.*

#### A. ASSEMBLE THE REAR SEAL

1. Install the rear seal o-rings onto the augers. Lubricate the outside of the o-rings with a generous amount Total Blend lubricant.
2. Lubricate the inside metal surface of the rear seals (Fig. 3-6) and install them onto the auger shafts. DO NOT lubricate the outside of the rear auger seals.



Figure 3-6 Lubricate Rear Seal

3. Lubricate the hex drive ends of the augers with a small amount of Total Blend lubricant.

#### B. ASSEMBLE THE AUGER

1. Screw the springs onto the studs in the plastic flights. The springs must be screwed into the flights completely to provide proper compression.
2. Install the two plastic flights onto the rear of the auger and insert it part way into the freezing cylinder.
3. Install the remaining plastic flights, push the auger into the freezing cylinder, and rotate slowly until the auger engages the drive shaft.
4. Apply a thin layer of sanitary lubricant to the inside and outside of the auger support bushings. Install the bushings onto the auger supports and install the auger supports into the front of the augers. Rotate the auger supports so that one leg of the support points straight up.

#### C. ASSEMBLE THE FRONT DOOR

1. Install the o-rings onto the spigot bodies and apply a thin layer of sanitary lubricant to the o-rings. Install the spigot bodies through the bottom of the front door.
2. Fit the front door o-ring into the groove on the rear of the front door.
3. Place the front door assembly on the mounting studs and the push front door against the machine carefully.

#### NOTE

*Make sure the pins of the front door do not touch the legs of the auger support.*

4. Secure the front door to the machine by placing the knobs on the studs and tightening until finger tight. Tighten in a crisscross pattern. Do not overtighten. Proper o-ring seal can be observed through the transparent front door.
5. Optional: Install the rosette caps or spigot extensions.

### 3.8 SANITIZING

Sanitizing must be done after the machine is clean and just before the machine is filled with mix. Sanitizing the night before does not ensure sanitization the next day. However, you should always clean the machine and parts after using it.

#### NOTE

*The United States Department of Agriculture and the Food and Drug Administration require that all cleaning and sanitizing solutions used with food processing equipment be certified for this use.*



**Figure 3-7 Mix Inlet Regulator**

When sanitizing the machine, refer to local sanitary regulations for applicable codes and recommended sanitizing products and procedures. The frequency of sanitizing must comply with local health regulations. Mix sanitizer in quantities of no less than 2 gallons of 90°F to 110°F (32°C to 43°C) water. Allow sanitizer to contact the surfaces to be sanitized for 5 minutes. Any sanitizer must be used only in accordance with the manufacturer's instructions and provide a 100 parts per million strength solution.

- A. For each freezing cylinder, Prepare 2 gallons of Stera-Sheen sanitizing solution following the manufacturer's instructions.
- B. Install the mix inlet regulators into the hoppers.
  1. With the standard style (Fig 3-7), insert it with the air tube towards the front of the machine.
  2. With the adjustable style, insert it with the bend towards the right.

**NOTE**

*Do not twist the mix inlet regulator when installing.*

- C. Pour the sanitizing solution into the hopper.
- D. Make sure the display shows the freezing cylinder is off. If it is not, press the On/Off button to turn it off.

**NOTE**

*If the freezing cylinder is not off, the control will not go into Clean mode. This is to protect from accidentally going into Clean mode with product in the cylinder.*

- E. Press the CLEAN button.
- F. Check for leaks.
  1. Check for leaks at the front door seal.
  2. Check the drain tray located under the front door for leaks coming from the rear of the rear auger seal.

- G. Use a sanitized soft bristle brush dipped in sanitizing solution to clean the hopper sides, the mix inlet regulator, and the underside of the hopper cover.
- H. After the five minute timer expires, open the spigot to drain the sanitizing solution.
- I. Press the CLEAN button to stop the auger. Allow the freezing cylinder to drain completely.

The machine is now sanitized and ready for adding mix.

**3.9 FREEZE DOWN AND OPERATION**

- A. Sanitize immediately before use.
- B. Fill the hopper with at least 2.5 gallons of mix.
- C. Place a container under the spigot and open the spigot to allow the mix to flush out about 8 ounces (0.23 liters) of sanitizing solution and liquid mix.
- D. Press the On/Off button to turn on the freezing cylinder.
- E. Allow the freezing cylinder to fill. Then press the PUSH TO FREEZE button.
- F. When the product is ready, the display reads "SERVE". Open the spigot to dispense product.

**NOTE**

*If the product consistency needs to be adjusted, use the Technician passcode and go to the Basic Settings menu. Adjust the CutIn Consistency Offset higher to increase the consistency or lower to decrease the consistency. Make adjustments in increments of 5 for best results.*

- G. The machine dispenses product at a reasonable draw rate. If the machine is overdrawn, the result is a soft product or a product that will not dispense at all. If this occurs, allow the machine to run for approximately 30 seconds before dispensing more product. A dispense rate adjustor is located under the header panel, to the immediate right of the spigot handle. Turning the knob counterclockwise decreases the dispense rate.
- H. Do not operate the machine when the MIX LOW message is displayed. Refill the hopper immediately.

**NOTE**

*After a preset number of freezing cycles in Serve mode, the control enters sleep mode and remains there until someone draws product or presses the PUSH TO FREEZE button. In the sleep mode, the machine keeps the product below 41°F (5°C). Sleep modes do not take the place of cleaning and sanitizing. Federal, State, and local regulatory agencies determine frequency of cleaning and sanitizing.*

### 3.10 MIX INFORMATION

Mix can vary considerably from one manufacturer to another. Differences in the amount of butterfat content and quantity and quality of other ingredients have a direct bearing on the finished frozen product. A change in machine performance that cannot be explained by a technical problem may be related to the mix.

Proper product serving temperature varies from one manufacturer's mix to another. Mixes should provide a satisfactory product in the 20°F to 24°F range. Diet and low-carb mixes typically freeze to proper consistency at higher temperatures.

When checking the temperature, stir the thermometer in the frozen product to get an accurate reading.

Old mix, or mix that has been stored at too high a temperature, can result in a finished product that is unsatisfactory. To retard bacteria growth in dairy based mixes, the best storage temperature range is between 33° to 38°F (0.5° to 3.3° C).

## SECTION 4 MAINTENANCE AND ADJUSTMENTS

This section is intended to provide maintenance personnel with a general understanding of the machine adjustments. It is recommended that any adjustments be made by a qualified person.



### WARNING

#### Hazardous voltage

Make sure the machine is off when disassembling for servicing. The machine must be disconnected from electrical supply before removing any access panel. Failure to disconnect power before servicing could result in death or serious injury.

### 4.1 FINE CONSISTENCY ADJUSTMENT

Product consistency can be adjusted on the Fine Consistency Adjustment screen. To get to the Fine Consistency Adjustment Screen, press the right arrow then the SEL button from the Current Status screen. Then move the cursor to the Fine Consistency Adjustment option and press the SEL button.

Increasing the Fine Consistency number increases the product consistency (firmer product). The Consistency Limits show the Fine Consistency adjustment added to the Consistency number.

Fine Consistency Adjustment Cylinder	Right
Changing the fine consistency changes the firmness of the product.	
Consistency CutIn Limit	00
Consistency CutOut Limit	00
_ Fine Consistency	00.0

**Figure 4-1 Fine Consistency Adjustment**

### 4.2 DRIVE BELT TENSION ADJUSTMENT

To check belt tension, refer to Figure 4-1 and follow the steps below:

- A. Remove the back panel.
- B. Use a Burroughs Belt Tension Gauge to set the tension for the drive belt. Set the belt tension to 35-40 lbs.
- C. If an adjustment is necessary, loosen the four motor plate retaining nuts, adjust belt tension then retighten the four nuts.



**Figure 4-1 Belt Tension Adjustment**

- D. Using a straightedge, check that the drive motor pulley is aligned with the speed reducer pulley. Align the pulley if necessary.

#### NOTE

*Belt life will be increased if new drive belts are tightened after two or three weeks of operation.*

### 4.3 CONDENSER CLEANING (AIR-COOLED MACHINES)

The air-cooled condenser requires periodic cleaning. To clean, refer to the following procedures.

- A. Disconnect power to the machine
- B. Remove the Phillips head screws from the right side panel, and remove the panel.
- C. To remove a condenser filter, grasp the top and pull off. Visually inspect the filter for dirt. If it is dirty, shake or brush excess dirt off of it and wash it in warm, soapy water. Once the filter is clean, rinse it thoroughly in warm, clear water and shake dry, taking care not to damage the it in any way.

#### NOTE

*If the condenser is not kept clean, refrigeration efficiency will be lost.*

### 4.4 PREVENTATIVE MAINTENANCE

It is recommended that a preventative maintenance schedule be followed to keep the machine clean and operating properly. The following steps are suggested as a preventative maintenance guide.

The United States Department of Agriculture and the Food and Drug Administration require that lubricants used in food zones be certified for this use. Use lubricants only in accordance with the manufacturer's instructions.

- A. Daily checks  
Check for any unusual noise or condition and repair immediately.
- B. Monthly checks  
Check the condenser filter for dirt and clean if necessary.
- C. Quarterly Checks  
Check drive belts for wear and tighten belts if necessary.

#### **4.5 EXTENDED STORAGE**

Refer to the following steps for storage of the machine over any long period of shutdown time:

- A. Thoroughly clean all parts that come in contact with mix with warm detergent water. Rinse in clear water and dry all parts. Do not sanitize.

#### **NOTE**

*Do not let cleaning solution stand in the freezing cylinder or hopper during the shutdown period.*

- B. Remove, disassemble, and clean the front door, and auger shaft. Leave disassembled during the shutdown period.
- C. Place the auger flights and auger support bushing in a plastic bag with a moist paper towel. This prevents them from becoming brittle if exposed to dry air over an extended period of time (over 30 days).
- D. For water-cooled machines that are left in unheated buildings, or buildings subject to freezing, the water must be shut off and disconnected. Disconnect the water inlet fitting. The fitting is located at the rear of the machine. Run the compressor for 2 - 3 minutes to open water valve (the front door must be attached for the compressor to run). Blow out all water through water inlet. Drain the water supply line coming to the machine. Disconnect the water outlet fitting.
- E. Press the Main Power On/Off button to turn the machine off.
- F. Disconnect the machine from the source of electrical supply.

## SECTION 5 TROUBLESHOOTING

### 5.1 ERROR CODES

When the machine experiences a problem, one of the following error codes is displayed on the control panel. Each error code directs you to the system location of the malfunction.

#### ERROR CODE MALFUNCTION

2*	High Torque
3*	Run Time
4	Clean
5	Freezing Cylinder Sensor
6	Hopper Sensor (single hopper machines)
7*	Drive Motor
8	Cab Sensor
9	High Pressure Cutout
10	Ambient Sensor
11*	Prime (cab units only)
12	Left Hopper Sensor
13	Right Hopper Sensor
21*	Spigot Open Time

\* After this error occurs, the machine goes into Sleep 3 mode where the compressor runs on timers and the drive motor does not run. The timers keep the product at a safe temperature until the machine can get serviced.

To return the machine to normal operation, any error causing condition must be corrected and the power to the affected freezing cylinder must be cycled. Turn the power to the freezing cylinder off then back on using the On/Off button of the affected freezing cylinder.

### 5.2 TROUBLESHOOTING - MACHINE

#### Error Code 2 - High Torque

If the control panel displays a High Torque Error (E2), the controller has sensed that the drive motor is running at a high load for 10 or more seconds. This may be due to the product consistency adjustment being set too high. Press the On/Off button for the cylinder to turn it off, wait until the product in the freezing cylinder thaws and then turn the cylinder back on. If the error persists, contact your Authorized Stoelting Distributor for further assistance.

#### Error Code 3 - Run Time

The Run Time Error (E3) occurs when the compressor runs continuously for an extended period. This error is generally caused by very low mix levels in the hopper or from product breakdown. Another common cause results from a restriction preventing mix from entering the freezing cylinder. Check the mix in the hopper. If the level mix is low, add mix. If there is a possibility that the mix has broken down, clean and sanitize the machine and replace the mix with fresh product.

Ice crystals in the hopper can clog the mix inlet system and prevent mix from entering the freezing cylinder. Thoroughly thaw mix per manufacturer's recommendations. To check for ice crystals, pour a small amount of product from the mix container through a clean and sanitized sieve or strainer. If ice crystals are in the mix, check temperature of the walk-in cooler where the mix is stored.

In air cooled machines, the Run Time Error may indicate that airflow within the machine has reduced or stopped. Check the sides of the machine for anything that would restrict airflow.

If the error persists after attempting to clear it, contact your Authorized Stoelting Distributor for further assistance.

#### Error Code 4 - Clean

If the machine is left in the Clean Mode for more than 20 minutes, the control panel displays a Clean Error (E4). This condition does not reflect a problem with the machine itself. The Clean Error has been programmed into the controller as a safeguard to protect the machine from potential damage caused by the machine being accidentally left in "Clean Mode". To clear the Clean Error, press the On/Off button for the cylinder to turn it off then back on.

### **Error Code 5 - Freezing Cylinder Sensor**

The Freezing Cylinder Sensor Error (E5) indicates a failure of the sensor or that the sensor is out of range. If the control panel displays an E5, press the On/Off button for the cylinder to turn it off then back on. If the error persists, contact your Authorized Stoelting Distributor for further assistance.

#### **NOTE**

*When the machine encounters a Freezing Cylinder Sensor Error, the machine continues to run using preset timers. This mode allows the operator to continue serving product until the machine can be serviced.*

### **Error Code 6 - Hopper Sensor (single hopper machines)**

The Hopper Sensor Error (E6) will not occur on the machine.

### **Error Code 7 - Drive Motor**

If the control panel displays a Drive Motor Error (E7), the control does not sense current coming from the drive motor. Press the On/Off button for the cylinder to turn it off then back on. If the error persists, contact your Authorized Stoelting Distributor for further assistance.

### **Error Code 8 - Cab Sensor**

A Cab Sensor Error (E8) will not occur on the machine.

### **Error Code 9 - High Pressure Cutout**

High Pressure Cutout Errors (E9) are usually caused by a dirty or inefficient condenser. If the control panel displays an E9 on an air cooled machine, check for proper air clearance around the machine. If there is an E9 on a water cooled machine check for proper flow from the water supply or kinks in the hoses.

If the error persists, contact your Authorized Stoelting Distributor for further assistance.

### **Error Code 10 - Auxiliary Sensor**

An Auxiliary Temperature Sensor Error (E10) occurs if the temperature sensor on the control board fails. Press the On/Off button for the cylinder to turn it off then back on. If the error persists, contact your Authorized Stoelting Distributor for further assistance.

### **Error Code 11 - Prime Error**

The Prime Error (E11) will not occur on the machine.

### **Error Code 12 - Left Hopper Sensor**

The Left Hopper Sensor Error (E12) indicates a failure of the hopper sensor or if the sensor is out of range. If the control panel displays an E12, press the On/Off button for the cylinder to turn it off then back on. If the error persists, contact your Authorized Stoelting Distributor for further assistance.

### **Error Code 13 - Right Hopper Sensor**

The Right Hopper Sensor Error (E13) indicates a failure of the hopper sensor or if the sensor is out of range. If the control panel displays an E13, press the On/Off button for the cylinder to turn it off then back on. If the error persists, contact your Authorized Stoelting Distributor for further assistance.

### **Error Code 21 - Spigot Open Time**

The Spigot Open Time Error (E21) indicates a failure of the spigot switch. If the control senses the spigot is open continuously for 10 minutes, the machine goes into Sleep 3 mode. If the control panel displays an E21, press the On/Off button for the cylinder to turn it off then back on. If the error persists, contact your Authorized Stoelting Distributor for further assistance.

### 5.3 TROUBLESHOOTING - MACHINE

PROBLEM	POSSIBLE CAUSE	REMEDY
<b>Machine does not run.</b>	<ol style="list-style-type: none"> <li>1 Power to machine is off.</li> <li>2 Freeze-up (auger will not turn).</li> <li>3 Front door not in place.</li> </ol>	<ol style="list-style-type: none"> <li>1 Supply power to machine.</li> <li>2 Turn machine off for 15 minutes, then restart.</li> <li>3 Assemble front door in place.</li> </ol>
<b>Machine will not shut off.</b>	<ol style="list-style-type: none"> <li>1 Refrigeration problem.</li> </ol>	<ol style="list-style-type: none"> <li>1 Check system. (Call distributor for service)</li> </ol>
<b>Product is too firm.</b>	<ol style="list-style-type: none"> <li>1 CutOut Consistency setting too high</li> </ol>	<ol style="list-style-type: none"> <li>1 Adjust the CutOut Consistency (See Section 3)</li> </ol>
<b>Product is too soft.</b>	<ol style="list-style-type: none"> <li>1 No vent space for free flow of cooling air.</li> <li>2 Condenser is dirty.</li> <li>3 CutOut Consistency setting too low</li> <li>4 Auger is assembled incorrectly.</li> <li>5 Refrigeration problem.</li> </ol>	<ol style="list-style-type: none"> <li>1 A minimum of 3" of air space on the sides. (See Section 2)</li> <li>2 Clean the condenser. (See Section 4)</li> <li>3 Adjust the CutOut Consistency (See Section 3)</li> <li>4 Remove mix, clean, reassemble, sanitize and freeze down.</li> <li>5 Check system. (Call distributor for service)</li> </ol>
<b>Product does not dispense.</b>	<ol style="list-style-type: none"> <li>1 No mix in hopper.</li> <li>2 Drive motor overload tripped.</li> <li>3 Drive belt failure.</li> <li>4 Freeze-up (Auger will not turn).</li> </ol>	<ol style="list-style-type: none"> <li>1 Add mix to the hopper.</li> <li>2 Wait for automatic reset. (If condition continues, call distributor for service.)</li> <li>3 Replace drive belt.</li> <li>4 Turn off cylinder, wait for 15 minutes, then restart.</li> </ol>
<b>Drive belt slipping or squealing.</b>	<ol style="list-style-type: none"> <li>1 Worn drive belt.</li> <li>2 Freeze-up (Auger will not turn).</li> <li>3 Not tensioned properly.</li> </ol>	<ol style="list-style-type: none"> <li>1 Replace drive belt.</li> <li>2 Turn off cylinder, wait for 15 minutes, then restart.</li> <li>3 Adjust belt tension</li> </ol>
<b>Rear auger seal leaks.</b>	<ol style="list-style-type: none"> <li>1 Outside surface of rear auger seal is lubricated.</li> <li>2 Rear seal missing or damaged.</li> <li>3 Seal o-ring missing, damaged or installed incorrectly.</li> <li>4 Worn or scratched auger shaft.</li> </ol>	<ol style="list-style-type: none"> <li>1 Clean lubricant from outside of rear seal and thoroughly clean rear of freezing cylinder. Lubricate inside of seal and reinstall.</li> <li>2 Check or replace.</li> <li>3 Check or replace.</li> <li>4 Replace auger shaft.</li> </ol>
<b>Front door leaks.</b>	<ol style="list-style-type: none"> <li>1 Front door knobs are loose.</li> <li>2 Spigot parts are not lubricated.</li> <li>3 Chipped or worn spigot o-rings.</li> <li>4 O-rings or spigot installed wrong.</li> <li>5 Inner spigot hole in front door nicked or scratched.</li> </ol>	<ol style="list-style-type: none"> <li>1 Tighten knobs.</li> <li>2 See Section 3.</li> <li>3 Replace o-rings.</li> <li>4 Remove spigot and check o-ring.</li> <li>5 Replace front door.</li> </ol>



## SECTION 6 REPLACEMENT PARTS

### 6.1 DECALS AND LUBRICATION

Part	Description	Quantity
208135	Brush - 4" X 8" X 16" (Barrel)	1
208380	Brush - 1/4" X 3" X 14"	1
208401	Brush - 1" X 3" X 10"	1
208467	Brush - 3/8" X 1" X 5"	1
236059	Card - Cleaning Instruction	1
C-1000-26C	Decal - Made In USA	1
324065	Decal - Water Inlet	1
324103	Decal - Caution Rotating Shaft	1
324105	Decal - Caution Electrical Shock	1
324106	Decal - Caution Electrical Wiring Materials	1
324107	Decal - Caution Hazardous Moving Parts	1
324125	Decal - Danger Electric Shock Hazard	1
324141	Decal - Caution Rotating Blades	1
324208	Decal - Attention Refrigerant Leak Check	1
324393	Decal - Stoelting Swirl Logo (Orange Leaf Only)	-
324509	Decal - Cleaning Instructions	1
324566	Decal - Wired According To	1
324584	Decal - Adequate Ventilation 3"	1
324594	Decal - Attention Heat Sensitive	1
324686	Decal - Danger Automatic Start	1
324803	Decal - Domed Stoelting Logo (Large) (Header Panel)	1
324884	Decal - Freshberry	-
324889	Decal - Orange Leaf	-
324898	Decal - Peachwave	-
324908	Decal - Mix Low Light	1
324909	Decal - USB Port	1
324910	Decal - Air Deflector	1
324911	Decal - Aspen Leaf	-
324916	Decal - Josie's	-
324941	Decal - Sweet Frog	-
508053	Lubricant - Total Blend (50 Packets)	-

## 6.2 AUGER SHAFT AND FACEPLATE PARTS

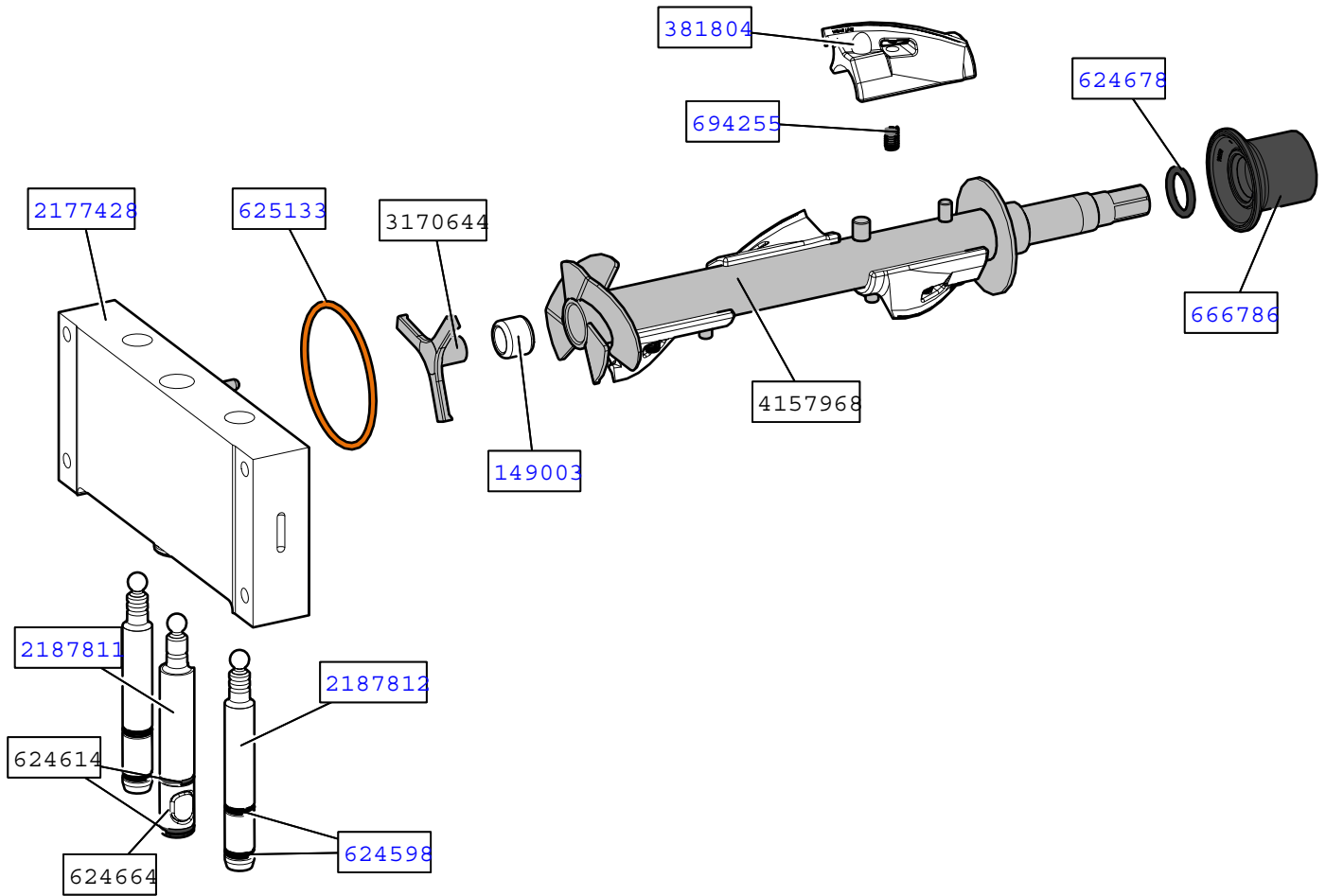

Part	Description	Quantity
149003	Bushing - Front Auger Support	2
381804	Auger Flight	10
482019	Knob - Front Door (Black)	4
624598-5	O-Ring - Outside Spigot - Black (5 Pack)	4
624614-5	O-Ring - Top & Bottom Center Spigot - Black (5 Pack)	2
624664-5	O-Ring - Middle Center Spigot - Black (5 Pack)	1
624678-5	O-Ring - Rear Seal - Black (5 Pack)	2
625133	O-Ring - Front Door - Red	2
666786	Seal - Rear Auger - Black	2
694255	Spring - Auger Flight	8
2177428	Door w/Pins	1
2187811	Spigot Body - Center	1
2187812	Spigot Body - Outer	2
2205440	Support - Front Auger	2
4157968	Auger Shaft	2

## 6.3 HOPPER PARTS



Part	Description	Quantity
232741	Cap - Rosette (6-Point Teardrop) (Translucent)	3
417006	Grid - Drip Tray (Vinyl Coated Metal)	1
624677-5	O-Ring - Mix Inlet & Spigot Extension - Black (5 Pack)	4
744273	Tray - Drip	1
744607	Tray - Drain	1
2149243-01	Mix Inlet Assembly - 3/16" Hole - Extended Length (2LA)	2
2177072	Extension - Spigot - 1.5"	-
2177073	Extension - Spigot - 2.5"	-
2177074	Extension - Spigot - 3.2"	-
2204806	Mix Inlet Assembly - Adjustable	2
2203352	Mix Inlet Regulator - Adjustable	-
2203353	Insert - Mix Inlet Regulator - Adjustable	-
2206054	Cover - Hopper (w/Compartments)	2

