



Model F431
SERVICE MANUAL

Manual No. [513605](#)

Rev.3

This manual provides basic information about the machine. Instructions and suggestions are given covering its operation and care.

The illustrations and specifications are not binding in detail. We reserve the right to make changes to the machine without notice, and without incurring any obligation to modify or provide new parts for machines built prior to date of change.

DO NOT ATTEMPT to operate the machine until instructions and safety precautions in this manual are read completely and are thoroughly understood. If problems develop or questions arise in connection with installation, operation, or servicing of the machine, contact Stoelting.



stoeltingfoodservice.com

Stoelting Foodservice Equipment
502 Highway 67
Kiel, WI 53042-1600
U.S.A.

Main Tel: 800.558.5807
Fax: 920.894.7029

Customer Service: 888.429.5920
Fax: 800.545.0662
Email: foodservice@stoelting.com

© 2014 PW Stoelting, LLC

A Few Words About Safety

Safety Information

Read and understand the entire manual before operating or maintaining Stoelting equipment.

This manual provides the operator with information for the safe operation and maintenance of Stoelting equipment. As with any machine, there are hazards associated with their operation. For this reason safety is emphasized throughout the manual. To highlight specific safety information, the following safety definitions are provided to assist the reader.

The purpose of safety symbols is to attract your attention to possible dangers. The safety symbols, and their explanations, deserve your careful attention and understanding. The safety warnings do not by themselves eliminate any danger. The instructions or warnings they give are not substitutes for proper accident prevention measures.

If you need to replace a part, use genuine Stoelting parts with the correct part number or an equivalent part. We strongly recommend that you do not use replacement parts of inferior quality.



Safety Alert Symbol:

This symbol Indicates danger, warning or caution. Attention is required in order to avoid serious personal injury. The message that follows the symbol contains important information about safety.

Signal Word:

Signal words are distinctive words used throughout this manual that alert the reader to the existence and relative degree of a hazard.



The signal word "WARNING" indicates a potentially hazardous situation, which, if not avoided, may result in death or serious injury and equipment/property damage.



The signal word "CAUTION" indicates a potentially hazardous situation, which, if not avoided, may result in minor or moderate injury and equipment/property damage.

CAUTION

The signal word "CAUTION" not preceded by the safety alert symbol indicates a potentially hazardous situation, which, if not avoided, may result in equipment/property damage.

NOTE (or NOTICE)

The signal word "NOTICE" indicates information or procedures that relate directly or indirectly to the safety of personnel or equipment/property.

SECTION 1 INTRODUCTION

Section	Description	Page
1	Introduction	
1.1	Description.....	1
1.2	Specifications	2
1.3	Modes of Normal Operation	3
A.	Initial Status.....	3
B.	Serve Mode.....	3
C.	Standby Mode	3
D.	Sleep 1 Mode	4
E.	Sleep 2 Mode	4
F.	IntelliTec Restart (Version 3.5 or Higher)	4
G.	Sleep 3 Mode (Version 3.5 or Higher).....	4
H.	Clean Mode.....	5
1.4	Mix Level Indicators	5
1.5	Storage Refrigeration	5
1.6	Operation During Sensor Failure.....	5
A.	Serve and Standby Mode.....	5
B.	Cabinet Refrigeration	5
1.7	Motor Profile Cutout Compensation	5
2	Installation Instructions	
2.1	Safety Precautions	7
2.2	Shipment and Transit.....	7
2.3	Machine Installation	8
2.4	Installing Permanent Wiring.....	8
2.5	Mix Pump.....	8
A.	Mix Pump Hose Installation.....	8
B.	Mix Pickup Hose Installation	9
C.	Mix Low Level Indicator Adjustment.....	12
3	Initial Set-Up and Operation	
3.1	Safety Precautions	13
3.2	Operating Controls and Indicators.....	13
3.3	Important Information Regarding Cleaning and Sanitizing	15
3.4	Disassembly of Machine Parts	16
A.	Disassembly of Front Door.....	16
B.	Disassembly of Auger	17
3.5	Cleaning Disassembled Parts	17
3.6	Sanitizing Machine Parts	17
3.7	Cleaning the Machine	18
3.8	Assembling Machine	18

Section	Description	Page
3.9	Sanitizing	19
3.10	Initial Freeze Down and Operation	20
A.	Adding Mix	20
B.	Preparing IntelliTec Control	21
C.	Initial Freeze Down	21
D.	Adjusting IntelliTec Control.....	21
E.	Serving Product.....	21
3.11	Normal Freeze Down and Operation	22
3.12	Mix Information	22
3.13	Operation of Mix Pump	23
3.14	Mix Pump Cleaning	23
3.15	Disassembly and Inspection of Removable Parts	23
4	Maintenance and Adjustments	
4.1	Machine Adjustment	25
4.2	Product Consistency Adjustment.....	25
4.3	Locking the Control Panel	25
4.4	Obtaining Readings and Modifying Settings (Service Personnel Only).....	25
4.5	Readings (Service Personnel Only)	26
4.6	Adjustments (Service Personnel Only).....	27
4.7	Other Settings (Service Personnel Only).....	27
4.8	Overrun Adjustment.....	28
4.9	Mix Pump Hose Reposition	29
4.10	Mix Pump Hose Replacement	29
4.11	Cab Temperature Adjustment	30
4.12	Drive Belt Tension Adjustment.....	30
4.13	Condenser Cleaning (Air-Cooled Machines)	31
4.14	Preventative Maintenance	31
4.15	Extended Storage.....	31
5	Refrigeration System	
5.1	Refrigeration System	33
5.2	Refrigerant Recovery and Evacuation.....	33
A.	Refrigerant Recovery	34
B.	Evacuating the Refrigeration System.....	34
5.3	Refrigerant Charging	34
5.4	Compressor	35
5.5	Condenser	36
5.6	Evaporator	36

Section	Description	Page
5.7	Valves	36
A.	Thermostatic Expansion Valve (TXV)	36
B.	Check Valve	37
C.	High Pressure Cutout	37
D.	Hot Gas Bypass	38
E.	Evaporator Pressure Regulator (EPR)	39
F.	Water Valve (Water Cooled Models Only)	40
5.8	Solenoid	40
5.9	Filter Drier	42
5.10	Capillary Tube & Drier Assembly	42
5.11	Cab Unit	43
6	Electrical and Mechanical Control Systems	
6.1	IntelliTec Controller	45
6.2	Contactors	45
6.3	Drive Motor	46
6.4	Capacitors	47
6.5	Gearbox	47
6.6	Condenser Fan Motor (Air-Cooled Only)	48
6.7	Cab Condenser Fan Motor	48
6.8	Switches	48
A.	Spigot Switch	48
B.	Pump Pressure Switch	50
6.9	Temperature Control Sensor	50
7	Troubleshooting	
7.1	Error Codes	51
7.2	Troubleshooting	51
7.3	Servicing Tip	53
7.4	Troubleshooting Machine	54
7.5	Troubleshooting Mix Pump	55
8	Replacement Parts	
8.1	Front Door and Auger Parts	57
8.2	Cab Tubing Assembly	58
8.3	Spigot Cam Assembly	59
8.4	Rear of Machine	60
8.5	Right Hand Side and Header Panel	61
8.6	Left Hand Side and Cab Interior	62
8.7	Front Panel	63
8.8	Part Kits	63
8.9	Pump Parts	64
8.10	Decals and Miscellaneous Parts	66
8.11	Stainless Steel Panels	66
8.12	Refrigeration Diagram and Wiring Diagram	67

SECTION 1 INTRODUCTION

1.1 DESCRIPTION

The Stoelting F431 floor model machine is pressure fed. The machine is equipped with fully automatic controls to provide a uniform product. The machine is designed to operate with almost any type of commercial soft-serve or non-dairy mixes available, including ice milk, ice cream, yogurt, and frozen dietary desserts.

This manual is designed to assist qualified service personnel in the installation, operation, maintenance, and service of the Stoelting Model F431 pressure machine.



Figure 1-1 Model F431 Machine

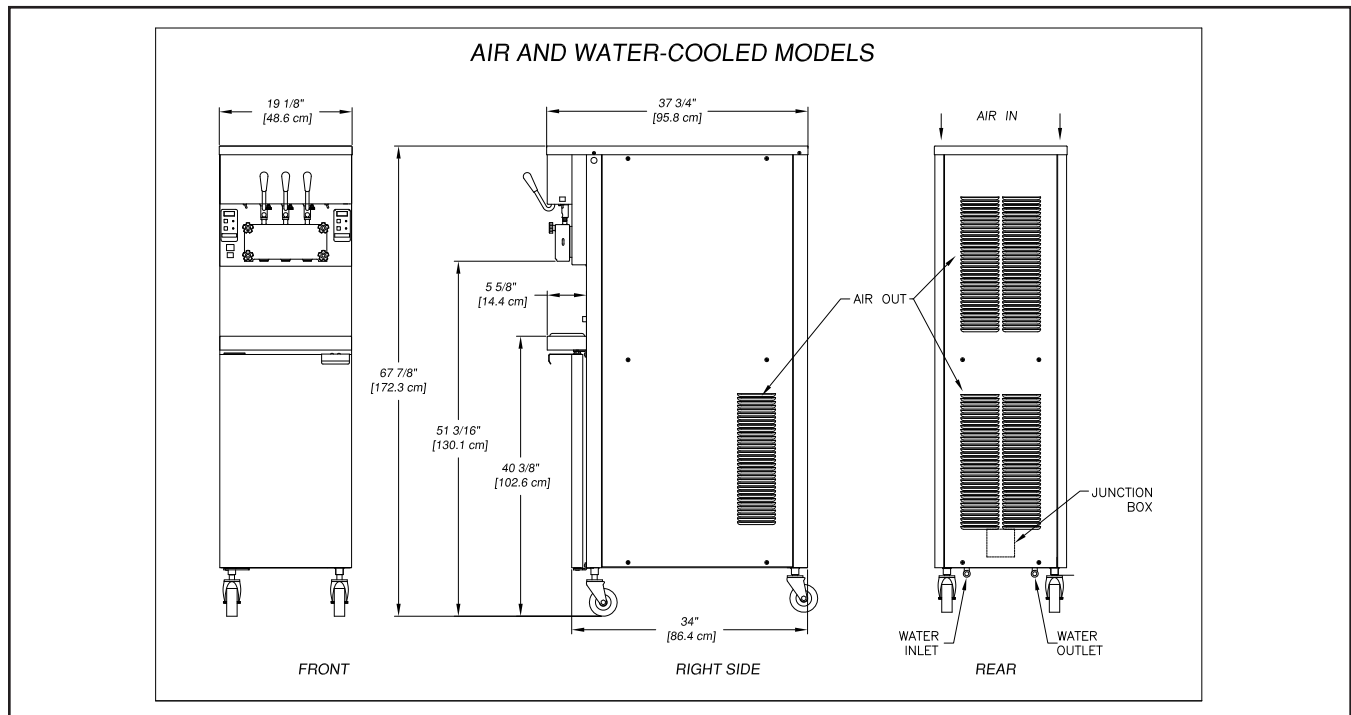

Figure 1-2 Specification

1.2 SPECIFICATIONS

Model F431			
Dimensions	Machine	with crate	
	width	19-1/8" (48,6 cm)	27" (68,6 cm)
	height	67-7/8" (172,4 cm)	78" (198,1 cm)
	depth	37-3/4" (95,9 cm)	48" (121,9 cm)
Weight	500 lbs (226,7 kg)	650 lbs (294,8 kg)	
Electrical	1 Phase, 208-240 VAC, 60Hz		
circuit ampacity	24A minimum		
overcurrent protection device	30A maximum		
International Option	1 Phase, 220-240 VAC, 50Hz		
Compressor	11,000 Btu/hr Scroll™ Compressor		
Drive Motor	Two - 3/4 hp		
Air Flow	Air cooled units require 3" (7,6 cm) air space on both sides, 6" back.		
Plumbing Fittings	Water cooled units require 1/2" N.P.T. water and drain fittings.		
Hopper Volume	Two - 5.5 gallons (20,82 liters)		
Freezing Cylinder Volume	Two - 0.85 gallon (3,22 liters)		

	F431
Refrigerant	R-404A
Charge	(W/C) 26 oz (A/C) 35 oz
Suction Pressure (at 72°F)	One Cylinder 20-22 psig Both Cylinders 25-27 psig Cab Only 18 psig
Discharge Pressure	240-260 psig
Cab Pressure (only cab running)	18 psig (maintained by the bypass valve)
EPR Valve	78-80 psig

Menu	Display	Value
Basic	CutOut	* amps
	Cut In T	19 °F
	Cycles	20 count
	Stir On	15 seconds
	Stir Off	300 seconds
Advanced	On Time	28 seconds
	Off Time	450 seconds
	Stb Time	120 minutes
	SI1DrvOn	120 seconds
	SI1DrOff	180 seconds
	SI2CutIn	32 °F
	SI2CtOut	28 °F
	DftOffTm	600 seconds
Storage (Left control only)	Refriger	** 3 Cabinet
	CabCutIn	38 °F
	CabCtOut	34 °F
	Cab Off	13 minutes
	Cab On	130 seconds

* CutOut amps must be set on site.

1.3 MODES OF NORMAL OPERATION

The IntelliTec control is Stoelting's newest and most advanced controller. It combines the best features of previous controllers, with advanced sensing and troubleshooting capabilities. Following are details of the operational modes on the F431 with an IntelliTec control.

NOTE:

The preset amounts, times, and temperatures listed below are references to actual settings on the IntelliTec control. Refer to Table 1-1 on page 6 for details on each setting.

A. INITIAL STATUS

When the Main Freezer Power and Freezing Cylinder switches are placed in the ON position, the machine will start in the "Sleep 1 Mode". The display will read "Sleep 1 Mode". The control will eventually move into the "Sleep 2" mode if the PUSH TO FREEZE button is not pressed. When the PUSH TO FREEZE button is pressed the control will move to the "Serve Mode".

B. SERVE MODE

When the PUSH TO FREEZE button is pressed or a spigot handle is pulled, the "Serve Mode" begins. The drive motor starts, and after a 3 second delay, the compressor starts. The display reads "FREEZING" on the top line and a bar on the bottom line increases with product consistency. A toroid on the IntelliTec control senses increasing drive motor amperage as the product comes to consistency in the freezing cylinder. When the control senses the product is at 75% of consistency, the display will read "SERVE", the amber LED will go out, and the green LED will light. At this time, product can be served from the machine. The drive motor and compressor will continue to run until the toroid reads a preset value (CutOut amps). When the toroid reads the CutOut amps on the drive motor, the compressor turns off. After a 3 second delay, the drive motor turns off. The product in the freezing cylinder is now at serving temperature and consistency.

After product is at consistency, the IntelliTec control continuously monitors refrigerant temperature through a thermistor mounted on the side of the freezing cylinder. When the temperature increases to a preset amount (Cut In T), a 3-second drive motor pre-stir analyzes product consistency. The pre-stir check is also performed each time the spigot handle is opened. This check prevents over-freezing of product, especially during frequent, small volume draws. If product requires a freezing cycle, the control will start the cycle.

During the "Serve Mode", a stir cycle starts. This cycle is independent of the freezing cycle and is based on preset times (Stir On and Stir Off). The stir cycle prevents product separation. If a freezing cycle is initiated, the timer is reset.

In addition to the "Serve Mode" freezing cycle, there is a freezing cycle based on a preset time (DftOffTime). If this time is attained without a freezing cycle, the control will automatically start a freezing cycle.

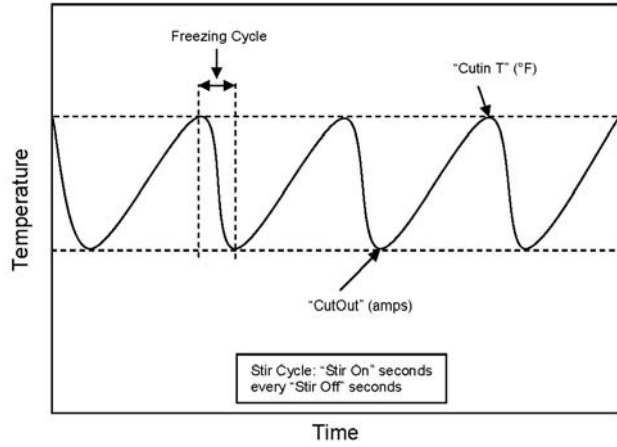

Figure 1-3 Serve Mode

The machine will remain in "Serve Mode" until the cycle count setting is attained. The cycle count is the number of active freezing cycles and is based on a preset value (Cycles). Once the cycle count has been reached without user interruption, the control will move into the "Standby Mode".

If the PUSH TO FREEZE button is pressed or a spigot handle is pulled, the cycle count is reset and the control will move to the beginning of the "Serve Mode". Refer to Figure 1-3 for a graphical representation of the "Serve Mode".

C. STANDBY MODE

If no product has been drawn from the spigot and the preset number of active freezing cycles is met, the control moves into the "Standby Mode". In "Standby Mode", the freezing cycle is based on preset timers (On Time and Off Time), and prevents ice crystals from building up in the product. Because the product remains partially frozen, it can quickly return to servable consistency when the PUSH TO FREEZE button is pressed.

During "Standby Mode", the stir cycle runs. This cycle is based on preset, timed intervals (Stir On and Stir Off) and prevents product separation.

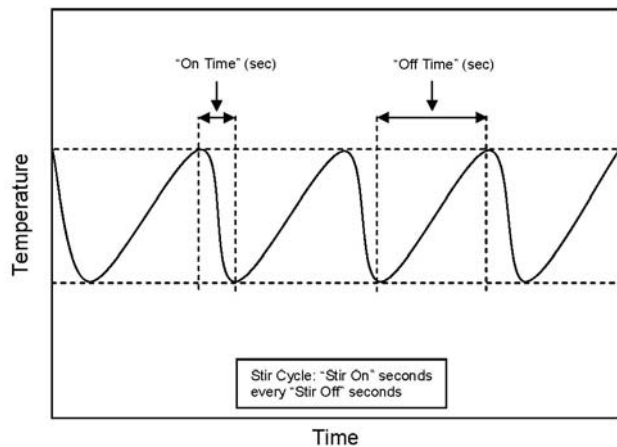

Figure 1-4 Standby Mode

The "Standby Mode" maintains product quality during slow times, while minimizing reactivation time. This mode lasts for a preset time (Stb Time). Once this time has been reached without user interruption, the control moves into the "Sleep 1 Mode". Refer to Figure 1-4 for a graphical representation of the "Standby Mode".

If a spigot is opened or the PUSH TO FREEZE button is pressed, the control will move to "Serve Mode". Product in the front of the freezing cylinders may or may not be at consistency. The state of the product is dependant on a number of variables but will come to consistency quickly.

D. SLEEP 1 MODE

After the "Standby Mode" time has expired without user interruption, the control will move into the "Sleep 1 Mode". During the "Sleep 1 Mode", the stir cycle is handled by preset timers (SI1DrvOn and SI1DrOff), and allows product to melt to a liquid state by using agitation cycles without any flow of refrigerant. Although the product temperature never increases above 40°F, the product thaws rapidly which minimizes product breakdown. The control will stay in the "Sleep 1 Mode" until sensing a preset temperature (SI2CutIn). When this temperature has been reached without user interruption, the control will move to the "Sleep 2 Mode". Refer to Figure 1-5 for a graphical representation of the "Sleep 1 Mode".

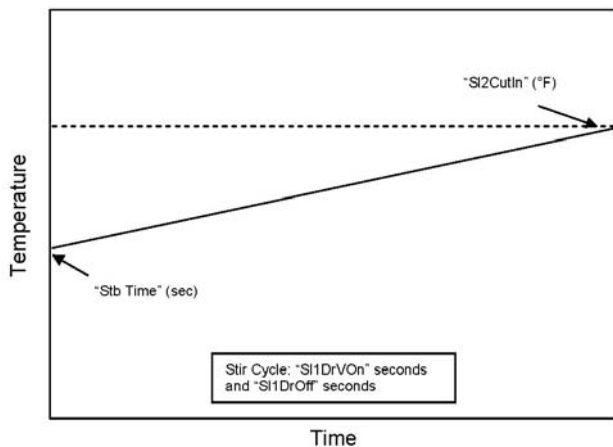

Figure 1-5 Sleep 1 Mode

If a spigot is opened or the PUSH TO FREEZE button is pressed, the control will move to "Serve Mode". If the spigot is opened in "Sleep 1 Mode", the product will not be at consistency. The operator must wait until the first "Serve Mode" freezing cycle has completed to serve product.

E. SLEEP 2 MODE

The "Sleep 2 Mode" maintains the freezing cylinder temperature between two preset values (SI2CutIn and SI2CtOut). During the "Sleep 2 Mode", the stir cycle runs. This cycle is based on preset, timed intervals (Stir On and Stir Off) and prevents product separation. The "Sleep 2 Mode" is often referred to by customers as the "night mode" and the machine will stay in this mode until a spigot is opened or the PUSH TO FREEZE button is

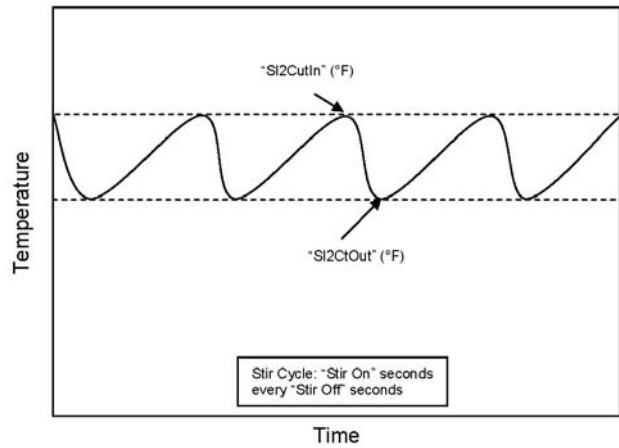

Figure 1-6 Sleep 2 Mode

pressed. When this occurs, the control will move to "Serve Mode". If the spigot is opened at this time, the product will be liquid. The operator must wait until the first "Serve Mode" freezing cycle has completed to serve product. Refer to Figure 1-6 for a graphical representation of the "Sleep 2 Mode".

F. INTELLITEC RESTART (VERSION 3.5 OR HIGHER)

If a hard error occurs (refer the hard error list below), the IntelliTec control will wait 5 minutes then attempt to clear the error by restarting itself. The control will count each restart attempt. The restart count will reset if the PUSH TO FREEZE button is pressed, the spigot is pulled, or the Freezing Cylinder OFF/ON switch is placed in the OFF position.

The following are considered hard errors:

ERROR CODE MALFUNCTION

- 2 High Torque
- 3 Run Time
- 4 Clean
- 7 Drive Motor
- 9 High Pressure Cutout

When a restart occurs, the second line of the display will read "Restart" and the backlight will blink. This will occur regardless of the system mode.

G. SLEEP 3 MODE (VERSION 3.5 OR HIGHER)

If a high torque, run time, or drive motor error condition occurs on the third restart attempt, the control will move to the "Sleep 3 Mode".

In "Sleep 3 Mode" freezing cylinder refrigeration will run for 4 seconds every 10 minutes. This ensures the product temperature never increases above 40°F. The stir cycle and the auger do not run during "Sleep 3 Mode".

The control will exit "Sleep 3 Mode" if the PUSH TO FREEZE button is pressed, the spigot is pulled, or the Freezing Cylinder OFF/ON switch is placed in the OFF position.

H. CLEAN MODE

When the CLEAN button is pressed on the left side, all hopper refrigeration stops. When the CLEAN button is pressed on the right side, only the right barrel freezing cycle stops. In either case, the drive motor of that barrel starts and will run for 20 minutes and a 5 minute count-down timer is displayed. After the time has elapsed, an optional audible alarm will sound if this accessory has been installed. The audible alarm is a reminder for the operator to end the "Clean Mode" when cleaning is completed.

If the machine is kept in "Clean Mode" for more than 20 minutes, the auger drive motor stops, the hopper refrigeration starts, and an error code (E4) is displayed on the display panel. The error code prevents damage to the machine that could occur during an extended clean mode (Refer to Section 8 - Troubleshooting for details). To clear this error, place the Freezing Cylinder Off-On switch in the Off position and back in the On position. If the machine is still being cleaned, pushing the CLEAN button will reset the timer and restart the "Clean Mode".

1.4 MIX LEVEL INDICATORS

The cabinet is equipped with a capacitive sensor to monitor mix level. When the mix level drops below the sensor limit, the lower line of the display will read "Low Mix" and the display will flash. To clear the "Low Mix" error, add mix to the cabinet's mix container.

1.5 STORAGE REFRIGERATION

The IntelliTec control is programmed to handle refrigeration of the cabinet independently from the barrel. The control maintains cabinet temperature between two preset values (CabCutIn and CabCtOut). If the cabinet door is opened during a refrigeration cycle, the evaporator fan will continue to run but the refrigeration cycle will be interrupted to prevent the evaporator coils from icing up.

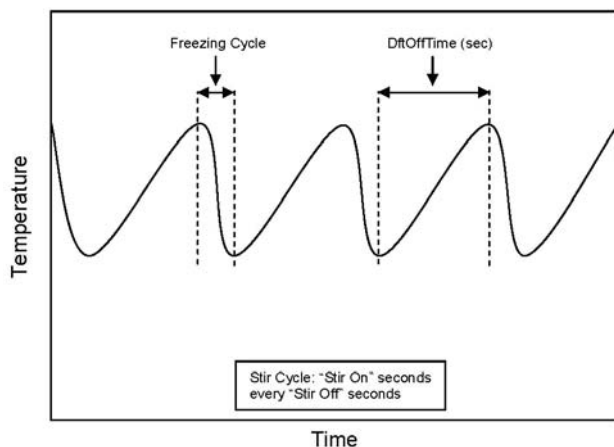

Figure 1-7 Serve Mode (Sensor Failure)

1.6 OPERATION DURING SENSOR FAILURE

The IntelliTec control is designed to allow the machine to continue to function if a temperature sensor failure occurs. If a sensor fails, the display will show the error and the control will run the machine on timers for the freezing cycle or cabinet refrigeration. This allows the operator to continue to serve product from the machine until proper servicing can be completed.

A. SERVE AND STANDBY MODE

In the event of a temperature sensor failure on a freezing cylinder, the IntelliTec control will function in two modes, "Serve Mode" and "Standby Mode". When the product is at consistency in "Serve Mode", the IntelliTec control uses a timer instead of the sensor and will not start another freezing cycle until a preset value (DfOffTme) is met.

The control will monitor product after it is at consistency, activating the stir cycle and counting the number of cycles. When the cycle count is reached, the control will move to "Standby Mode".

The "Standby Mode" is the same as in normal operation with the exception of when the preset time (Stb Time) is met, the control moves back into the "Serve Mode". Refer to Figure 1-7 for details.

B. CABINET REFRIGERATION

In the event of a temperature sensor failure in the cabinet, the cabinet refrigeration cycle is managed by preset times (Cab On and Cab Off). This refrigeration cycle is independent of the barrel refrigeration and the cycle restarts if the cabinet door is opened.

1.7 MOTOR PROFILE CUTOUT COMPENSATION

The IntelliTec control is programmed to automatically function at a range of supply voltages. This feature provides the advantage of having product maintained at a specific temperature and consistency irrespective of the supply voltage. A motor profile curve is programmed on the IntelliTec control and provides a relationship between the supply voltage and drive motor cutout amperage. Depending on the supply voltage, the control varies cutout amperage according to the motor profile. This feature is automatic and does not need any configuring.

IntelliTec Control Setting Specifications

Basic Menu	DISPLAY	Value	MODE	DEFINITION
	CutOut	*	Serve	Amp draw setting for cut out
	Cut In T	19°F	Serve	Temperature setting for cut in
	Cycles	20	Serve	Freezing cycles before going into Standby Mode
	Stir On	15 sec	Serve	Stir-only on time
	Stir Off	300 sec	Serve	Stir-only off time

Advanced Menu	DISPLAY	Value	MODE	DEFINITION
	On Time	28 sec	Standby	Freezing cycle “on” time (runs on timers only)
	Off Time	450 sec	Standby	Freezing cycle “off” time
	Stb Time	120 sec	Standby	Total time in mode
	SI1DrvOn	120 sec	Sleep 1	Drive motor “on” timer
	SI1DrOff	180 sec	Sleep 1	Drive motor “off” timer
	SI2CutIn	32°F	Sleep 2	Cut in temperature
	SI2CtOut	28°F	Sleep 2	Cut out temperature
	DftOffTm	600 sec	No Sensor	Default “off” time. Used in case of sensor failure

Storage Menu	DISPLAY	Value	MODE	DEFINITION
	Refriger	Cabinet	All	Set to None, 1 Hopper, 2 Hopper, or Cabinet
	CabCutIn	38°F	All	Refrigerated cab cut in temperature
	CabCtOut	34°F	All	Refrigerated cab cut out temperature
	Cab Off	13 min	No Sensor	Default “off” time. Used in case of sensor failure
	Cab On	130 sec	No Sensor	Default “on” time. Used in case of sensor failure

* The CutOut value needs to be adjusted to product requirements. Refer to the 2183408 - Specification Sheet for F431 Control located in the plastic pouch behind the header panel.

Table 1-1 IntelliTec Control Setting Specifications

SECTION 2 INSTALLATION INSTRUCTIONS

2.1 SAFETY PRECAUTIONS

Do not attempt to operate the machine until the safety precautions and operating instructions in the manual are read completely and are thoroughly understood.

Take notice of all warning labels on the machine (see Figure 2-1). The labels have been put there to help you maintain a safe working environment. The labels have been designed to withstand washing and cleaning. All labels must remain legible for the life of the machine. Labels should be checked periodically to be sure they have not been painted over, rubbed off, fallen off, and can be recognized as warning labels.

If you are in need of replacement labels, indicate the part number, type of label, location of label, and quantity required along with your name and address and mail to:

Stoelting, LLC
Commercial Products
502 Hwy. 67
Kiel, WI 53042

2.2 SHIPMENT AND TRANSIT

The machine has been assembled, operated, and inspected at the factory. Upon arrival at the final destination, the machine must be checked for any damage which may have occurred during final transit.

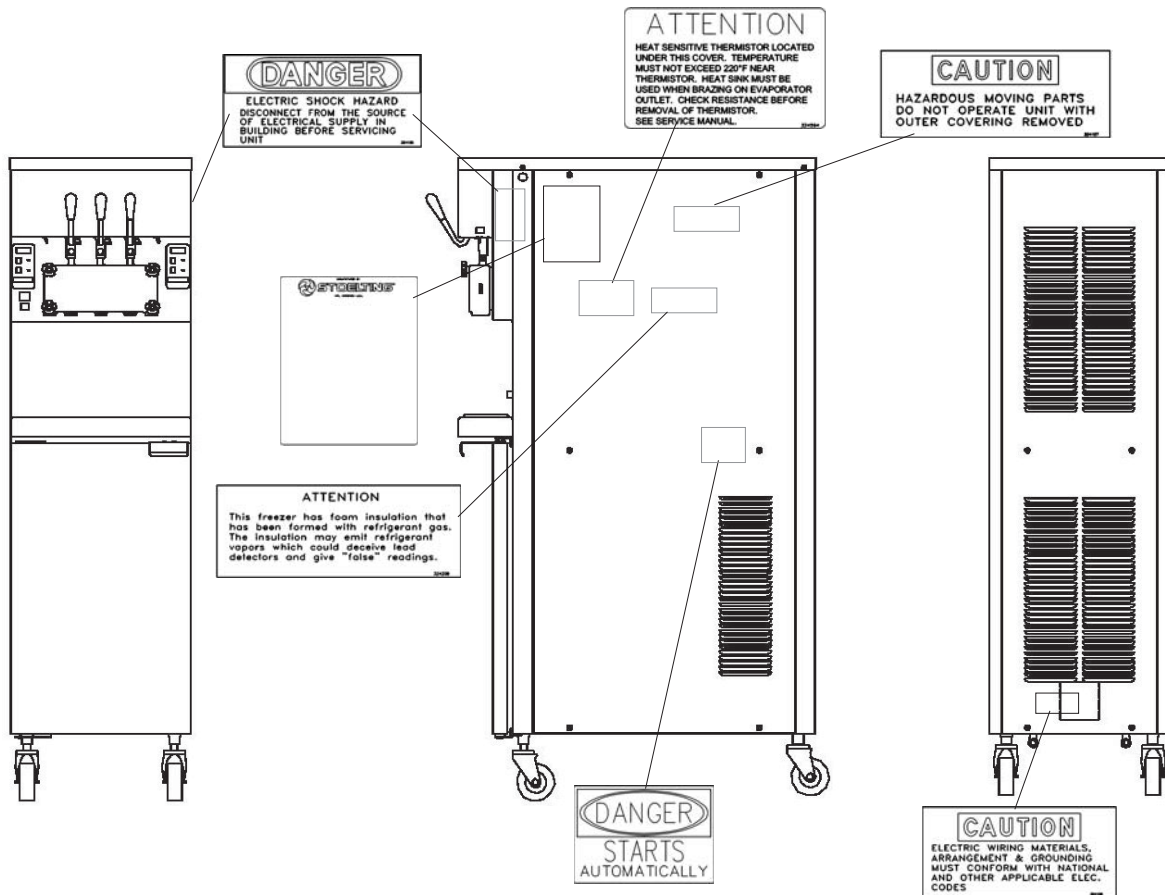

Figure 2-1 Warning Label Locations

ITEM	STOELTING PN	QTY		DESCRIPTION
		-03	-04	
1	324801	2	2	DECAL - MIX LOW
2	324798	2	2	DECAL CLEAN-OFF-SERVE SWITCH
3	324141	1	1	DECAL CAUTION-ROTATING BLADES
4	723526	1	1	TAG READ MANUAL & ALL DECALS
5	324346	3	3	DECAL HAZARDOUS MOVING PARTS
6	324393	1	1	DECAL STOELTING SWIRL LOGO
7	324800	1	1	DECAL - CAB ON/OFF
8	324799	2	2	PUMP ON/OFF
9	324208	2	2	DECAL REFRIG LEAK CHECK
10	324509	1	1	DECAL CLEANING (SS & SHAKE)
11	324103	2	2	DECAL CAUTION-ROTATING SHAFT
12	324686	4	4	DECAL DANGER AUTOMATIC START
13	324107	2	2	DECAL CAUTION MOVING PARTS
14	324125	7	7	DECAL ELECT SHOCK HAZARD
15	324151	2	2	DECAL FIELD CONNECTIONS
16	324198	-	2	DECAL ATTENTION INSTALLER
17	130000	2	2	BAG, ENVELOPE FRONT LOADING
18	324584	1	1	DECAL, ADEQUATE VENTILATION (3")
19	324158	2	2	DECAL COPPER CONDUCTORS ONLY
20	324106	2	2	DECAL CAUTION WIRING MAT'L
21	324107	4	4	DECAL CAUTION MOVING PARTS
22	324566	2	2	DECAL - WIRED ACCORDING TO
23	324015	-	2	DECAL 2X1-1/4 BLK ON WHITE
24	723552	2	2	TAG, CAUTION - SUPPLY VOLTAGE
26	324804	1	1	DECAL - GM HEADER (STOELTING SWIRL)
26	324803	1	1	DECAL - GM HEADER (STOELTING LOGO)
26	324806	1	1	DECAL, A&W HEADER FOR U431 & 4231
27	324346	2	2	DECAL-CAUTION HAZARDOUS MOVING
28	324797	2	2	DECAL, STANDBY/SERVE SWITCH
29	324242	1	1	DECAL, TEMPERATURE CONTROL
30	324200	2	2	DECAL, MANUAL RESET
31
32	324014	2	2	DECAL, ARROW
33	314796	2	2	DECAL, FREEZING

With the method of packaging used, the equipment should arrive in excellent condition. THE CARRIER IS RESPONSIBLE FOR ALL DAMAGE IN TRANSIT, WHETHER VISIBLE OR CONCEALED. Do not pay the freight bill until the machine has been checked for damage. Have the carrier note any visible damage on the freight bill. If concealed damage and/or shortage is found later advise the carrier within ten days and request inspection. The customer must place claim for damage and/or shortages in shipment with the carrier. Stoelting, LLC cannot make any claims against the carrier.

2.3 MACHINE INSTALLATION

Installation of the machine involves moving the machine close to its permanent location, removing all crating, setting in place, assembling parts, and cleaning.

- A. Uncrate the machine.

 WARNING
<p>Installation must be performed by a qualified electrician/refrigeration specialist. Incorrect installation may cause personal injury, severe damage to the machine and will void factory warranties.</p>

- B. Install the four casters. Turn the threaded end into the machine until zero threads are showing. To level, turn out casters no more than 1/4" maximum, then tighten all jam nuts.
- C. The machine must be placed in a solid level position.

NOTE

Accurate leveling is necessary for correct drainage of machine barrel and to insure correct overrun.

- D. Machines with air cooled condensers require a minimum of 3" (7,5cm) of space on all sides and 10" (25cm) at the top for proper circulation. A minimum of 6" (15cm) side clearance is required in high ambient conditions (>98°F).
- E. Soft serve machines with water cooled condensers require 1/2" NPT supply and drain fittings.

2.4 INSTALLING PERMANENT WIRING

CAUTION
<p>Risk of product damage Air cooled condenser requires proper ventilation. Failure to provide adequate ventilation will void factory warranties.</p>

If permanent wiring is required by local codes, the following procedure must be performed:

- A. Refer to the nameplate on the side panel of the machine for specific electrical requirements. Make sure the power source in the building matches the nameplate requirements.

 WARNING
<p>Hazardous voltage High voltage will shock, burn or cause death. Turn off and lock out main power disconnect before installing wiring. Do not operate machine with cabinet panels removed.</p>

- B. Remove the back panel and the junction box cover located at the bottom of the machine.
- C. Install permanent wiring according to local code.
- D. Check the auger shaft rotation by placing the Main Freezer Power Switch in the ON position, placing both Freezing Cylinder OFF/ON switches in the ON position and pressing the CLEAN button on each of the control panels. Auger shaft rotation is clockwise as viewed through the clear plastic front door (see Figure 2-2).
- E. Press the CLEAN button to stop the augers.

2.5 MIX PUMP

A. MIX PUMP HOSE INSTALLATION

Follow the steps below to install the mix pump hose in the cabinet part of the machine.



Figure 2-2 Auger Rotation

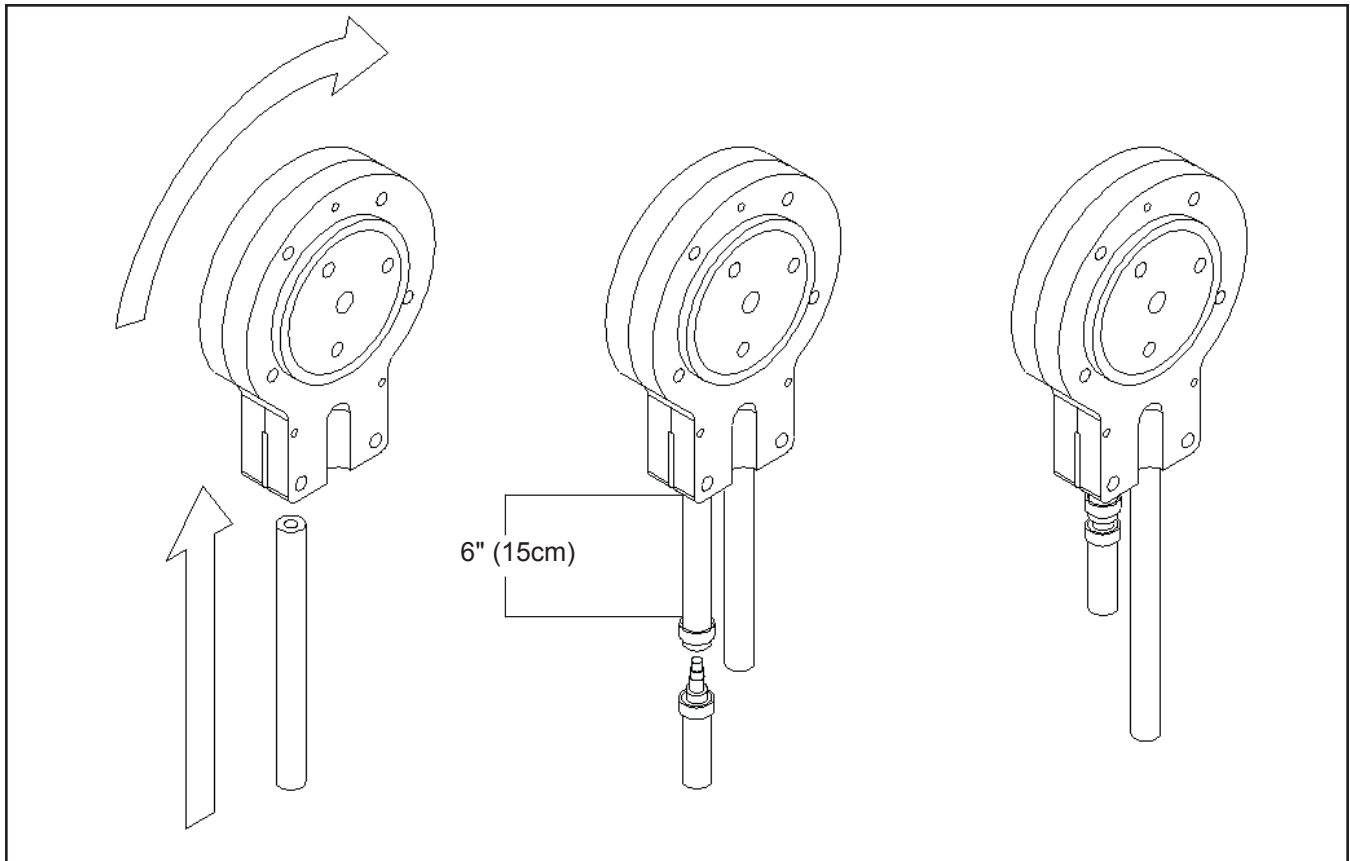

Figure 2-3 Mix Hose Installation

1. Turn pump on.
2. Feed one end of mix pump hose into the entering or pickup hose side (left) of black cover.

NOTE

Feed the tube into the clamp so the natural curve of the tube is towards the outside of the black cover. This prevents the hose from looping around the black cover twice.

3. Gently push the hose into the black cover until it begins to feed.
4. Allow the hose to feed itself through the pump until 6" (15cm) remains on the entering side.
5. Turn pump off.
6. Connect mix pump hose to the elbow fitting (located on the left side of the mix line manifold) using small hose clamp. Be careful not to twist the mix hose.
7. Turn pump on.
8. Allow remaining 6" (15cm) of tubing to feed through pump until hose adapter prevents further feeding.
9. Turn pump off.
10. Connect free end of mix pump hose to 3-way Tee as shown in Figure 2-4. When all connections are complete the 3-way Tee must be lower than the black pump housing.

CAUTION

Risk of product damage

Air/mix Tee must remain below the black cover/clamp. If Tee is above the pump, mix will drain to the air compressor resulting in pump damage.

B. MIX PICKUP HOSE INSTALLATION

The F431 machine may be connected to standard mix containers or prepacked mix bags. One, 5 gallon mix bag may be connected to each freezing cylinder or two 2-1/2 gallon bags may be connected on each side. Follow the instructions below that match your configuration.

When Using One Mix Container Per Side:

1. Connect a 2" (5cm) length of 3/8" (9,5mm) ID plastic food grade tubing to the mix pickup assembly. Secure with hose clamps. Then place assembly through hole in cover and install retaining clip (see Figure 2-4 and 2-5).
2. Connect the free end of tubing to the mix check valve. Observe direction of check valve flow arrow. Secure with hose clamp. Connect 24" (61cm) length of 3/8" (9,5mm) ID plastic food grade tubing to free end of check valve and secure with hose clamp.

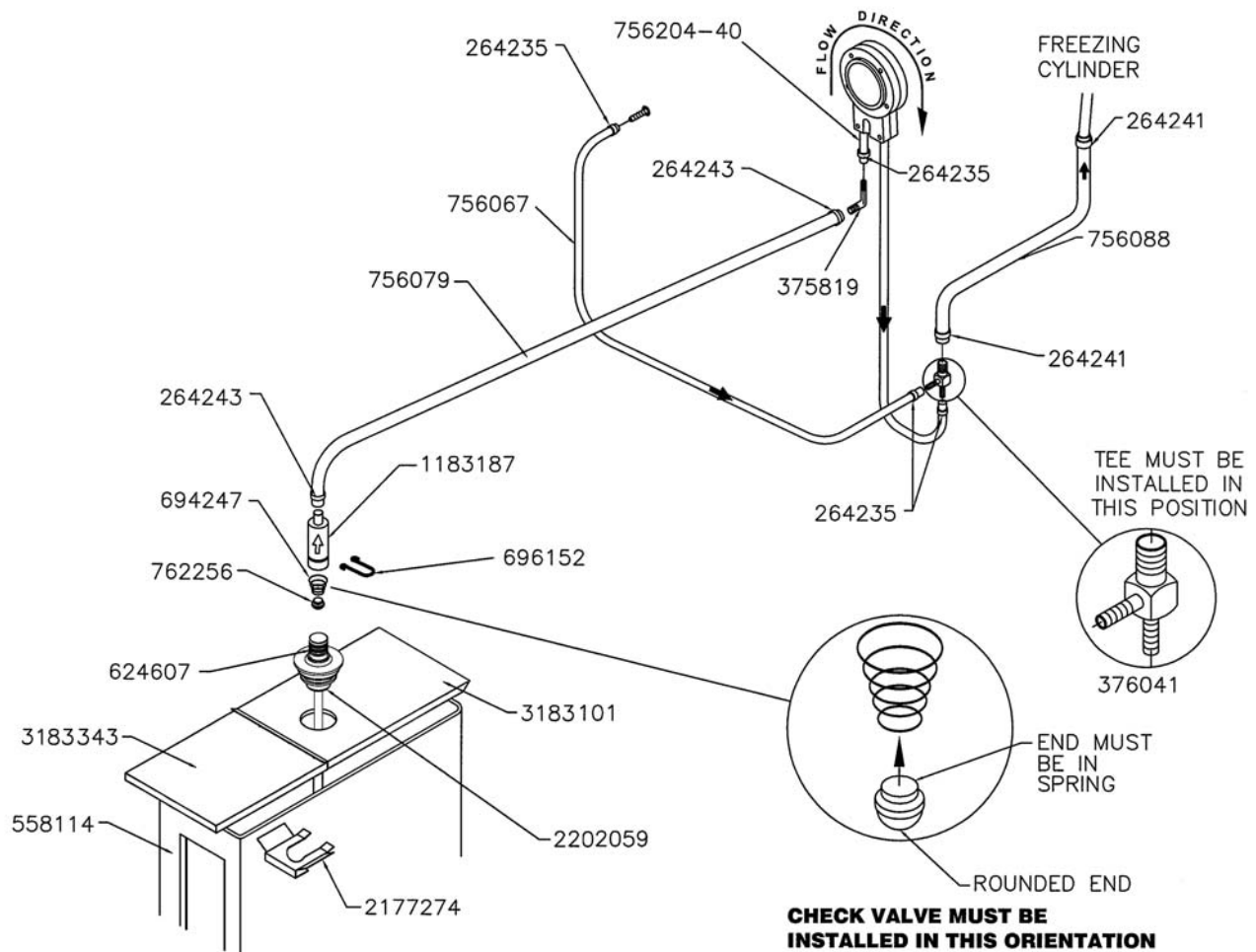

Figure 2-4 Mix Pump Connections for Standard Mix Container

3. Connect elbow fitting to free end of tubing. Connect opposite end of elbow to 1/4" ID tan tubing on the left side of pump head. Secure with hose clamps (see Figure 2-3 and 2-4).

When Using Bag Connection System (BCS) with Two Bags Per Side (optional kit #2183189):

1. Connect 3/8" (9,5mm) ID plastic food grade tubing to a bag adapter. Secure with hose clamps. This bag adapter will connect to the bag nearest the front of the machine.
2. Slide the hose clip over free end of 3/8" (9,5mm) ID plastic food grade tubing. Attach free end of tubing to a manifold adapter. Secure with large hose clamp or equivalent. Push the manifold adapter into the left port of the mix inlet manifold and secure with retaining clip. (See Figure 2-7).
3. Connect 3/8" (9,5mm) ID plastic food grade tubing to a bag adapter. Secure with hose clamps. This bag adapter will connect to the bag nearest the back of the machine.



Figure 2-5 Connecting Mix Pick-up Assembly



Figure 2-6 Connecting Pump Hose to BCS Manifold



Figure 2-7 Completed BCS Hose Assembly

4. Attach free end of tubing to a manifold adapter. Secure with large hose clamp or equivalent. Push the manifold adapter into the right port of the mix inlet manifold and secure with retaining clip. (See Figure 2-7).
5. Place two mix bags into each mix container as shown in Figure 2-8 (left mix container shows two bag configuration).
6. Connect the bag adapter attached to the left side of the manifold to the mix bag in the front of the mix container (nearest the cabinet door). Connect the bag adapter attached to the right side of the manifold to the mix bag in the back of the mix container (see Figure 2-8).

When Using Bag Connection System (BCS) with One Bag Per Side (optional kit):

1. Connect 3/8" (9,5mm) ID plastic food grade tubing to a bag adapter. Secure with hose clamps.
2. Connect free end of 3/8" (9,5mm) ID plastic food grade tubing to mix check valve. Observe direction of check valve flow arrow. Secure with hose clamp. Connect 3/8" (9,5mm) ID plastic food grade tubing to free end of check valve and secure with hose clamp.
3. Connect elbow fitting to free end of tubing. Connect opposite end of elbow to 1/4" ID tan tubing on the left side of pump head. Secure with hose clamps (see Figure 2-3 and 2-4).

4. Place one mix bag into each mix container as shown in Figure 2-8 (right mix container shows one bag configuration).
5. Connect the bag adapter to the mix bag. (See Figure 2-8).



Figure 2-8 Connecting BCS Mix Bags (two bag connection on left, one bag connection on right)

When Using Two Mix Containers or Bag Connection Systems (BCS) on one Side (optional kit #2183189):

1. The F431 can be configured to operate with only one freezing cylinder turned on. This may be done if only one flavor is being dispensed during slow times. In this case, running only one freezing cylinder will help minimize product breakdown, while reducing mix container filling or mix bag replacement.
2. Connect two mix containers or two mix bags as described above, but connect both containers to the mix line manifold of the freezing cylinder you will be using.

C. MIX LOW LEVEL INDICATOR ADJUSTMENT

The sensitivity of the “Mix Low” indication that displays on the control panel can be adjusted to operator preference. If more advanced notice of low mix is required, simply loosen the black adjustment knobs located on the sensor brackets at the back of the machine cabinet, and slide the bracket upwards. If the “Mix Low” message appears while there is still sufficient mix in the container, slide the bracket downward. Be sure to tighten the adjustment knobs after properly positioning the sensor (see Figure 2-6).

SECTION 3 INITIAL SET-UP AND OPERATION

3.1 SAFETY PRECAUTIONS

SAFE OPERATION IS NO ACCIDENT; observe these rules:

- A. Know the machine. Read and understand the operating instructions.
- B. Notice all warning labels on the machine.
- C. Wear proper clothing. Avoid loose fitting garments, and remove watches, rings or jewelry which could cause a serious accident.
- D. Maintain a clean work area. Avoid accidents by cleaning the area and keeping it clean.
- E. Stay alert at all times. Know which switch, push button or control you are about to use and what effect it is going to have.
- F. Disconnect electrical power for maintenance. Never attempt to repair or perform maintenance on the machine until the main electrical power has been disconnected.
- G. Do not operate under unsafe operating conditions. Never operate this machine if unusual or excessive noise or vibration occurs.

3.2 OPERATING CONTROLS AND INDICATORS

Before operating the machine, it is required that the operator know the function of each operating control. Refer to Figure 3-1 for the location of the operating controls on the machine. For the information regarding error codes displayed on the control panel, refer to the troubleshooting section of this manual.

WARNING

Hazardous voltage

The Main Freezer Power switch must be placed in the OFF position when disassembling for cleaning or servicing. The machine must be disconnected from electrical supply before removing any access panel. Failure to disconnect power before servicing could result in death or serious injury.

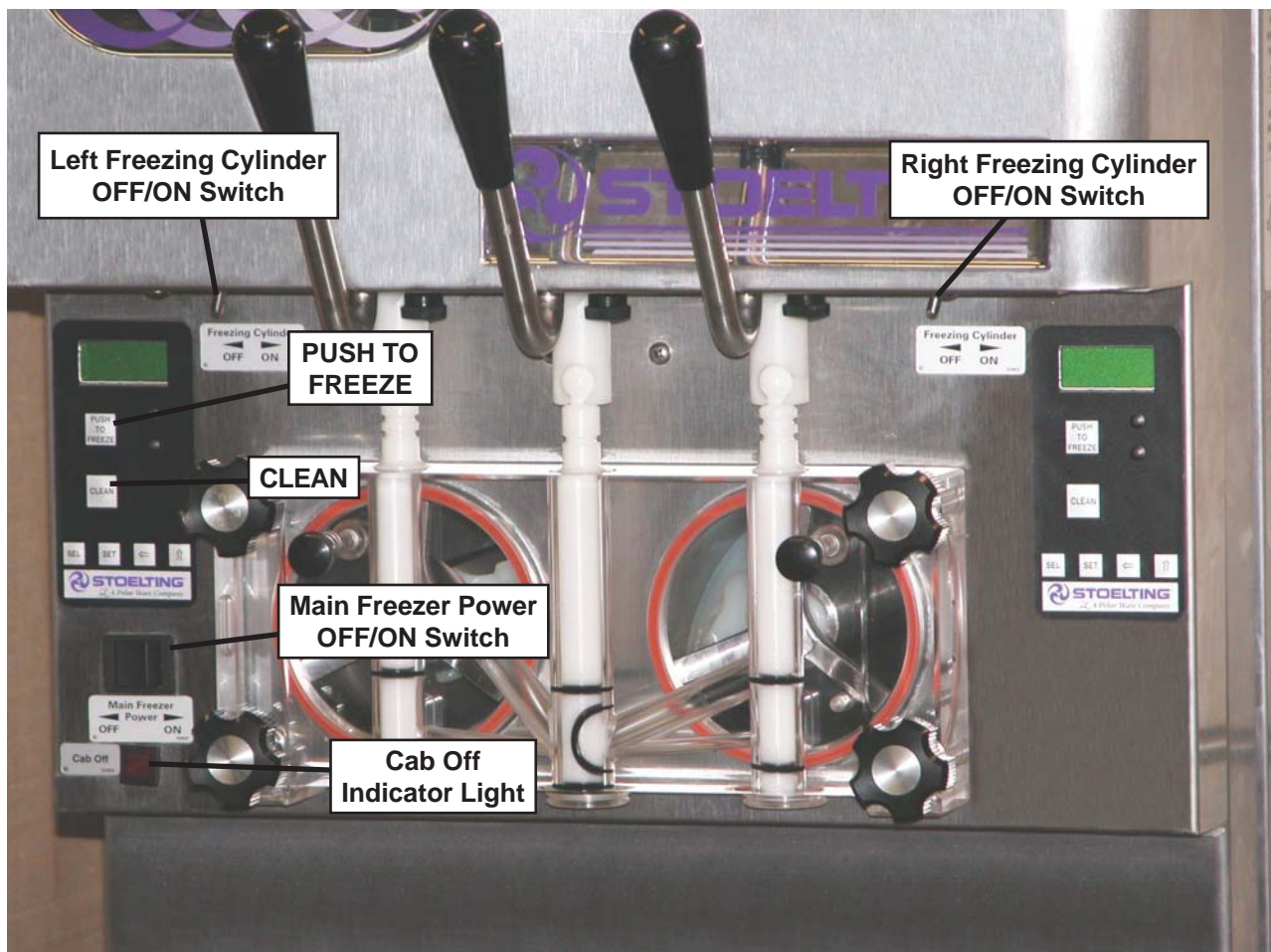

Figure 3-1 Controls

A. Main Freezer Power Switch

The Main Freezer Power switch is a two position rocker switch that supplies power to the IntelliTec control, freezing cylinder circuits and lower cabinet refrigeration system. When the switch is placed in the ON position, the lower cabinet refrigeration system will run until the preset temperature is reached; then cycle ON and OFF to maintain that temperature. Power to individual freezing cylinders can then be controlled with the Freezing Cylinder OFF/ON switches.

B. Freezing Cylinder OFF/ON Switch

The Freezing Cylinder OFF/ON switches are two position toggle switches used to supply power to the left or right freezing cylinder control circuit. When the switch is in the OFF position, the refrigeration system and auger will not operate. When the switch is in the ON position, the machine will be operational.

C. Spigot Switch

The spigot switch is mounted to the spigot cam assembly behind the header panel. When the spigot is opened to dispense product, the spigot switch opens and the "Serve Mode" begins.

D. Cab Off Indicator Light

A flashing light indicates the Main Freezer Power Switch is in the OFF position; no refrigeration is being supplied to the cab. Place the Main Freezer Power switch in the ON position for cab refrigeration.

E. Pump Switch

The pump motor switches are the two rocker switches located in the upper left-hand side of the refrigerated cab. When a switch is placed in the OFF position, the pump will not run. When the switch is placed in the ON position, the pump will run until the preset pressure is reached, then cycle on and off as product is drawn to maintain that pressure.

F. Push To Freeze Button

The PUSH TO FREEZE button is a membrane or "snap" switch used to initiate "Serve Mode".

NOTE

After the PUSH TO FREEZE button is pressed, the drive motor starts. After a 3-second delay, the compressor will start.

G. LEDs

The membrane switch (touchpad) features two lights; a green LED and an amber LED. The green LED is lit during "Serve Mode". During freeze down, it is not lit. When product consistency approaches 75% in the freezing cylinder, the green LED flashes. The amber LED is on during all other modes. In the event of an error or when the freezing cylinder is off, both LEDs alternatively flash.

H. Clean Button

The CLEAN button is a membrane, or "snap" switch. When the button is pressed, the freezing cycle stops and the drive motor will start. A CLEAN message will display on the LCD screen along with a 5-minute countdown timer. If the button is pressed again, the timer will reset. To exit the CLEAN mode, turn the Freezing Cylinder OFF/ON switch to the OFF position. If the machine is left in CLEAN for more than 20 minutes, an error code (E4) will be displayed on the display panel. Place the Freezing Cylinder OFF/ON switch in the OFF position and back in the ON position to clear this error.

I. Mix Low Light Indicator

A MIX LOW message will appear on the LCD display to alert the operator of a low mix condition. The message will display when there is approximately one gallon of mix left in the mix container or when one bag of the Bag Connection System (BCS) is empty. When the MIX LOW message is displayed, refill container or replace bag immediately.

J. Dispense Rate Adjusters

The dispense rate adjuster limits the opening of the spigot. To adjust product dispense rate, turn the adjusting knob clockwise for slower flow and counterclockwise for faster flow. It takes at least five complete turns of the adjusting knob to make a noticeable difference in the dispense rate.

K. High Head Pressure Cutout

If the head pressure exceeds 445 psig (28 bar), the high head pressure cutout will trip. It will automatically reset after about 10-15 minutes.

L. Front Door Safety Switch

The front door safety switch prevents the auger from turning when the front door is removed. The switch is open when the door is removed and closed when the door is properly installed.

M. Menu Navigation Buttons

The Menu Navigation Buttons allow the user to display information regarding the machine's status of operation as well as adjust product consistency (Fig. 3-2).



Figure 3-2 IntelliTec Control

Selection Button (SEL) The SEL button is used in combination with the up arrow to enter into the settings of the IntelliTec control. This button is also used to navigate through the control settings menu.

Set Button (SET) During normal operation the SET button is used to save a change made to the product consistency setting. It is also used to save changes when modifying control settings.

Left Arrow Button (←) During normal operation, if the left arrow button is pressed for 5 seconds, the display will remain lit. To turn the light off, press the left arrow button for 5 seconds. The left arrow button is used primarily to navigate through the control settings.

Up Arrow Button (↑) Under normal operation, after pressing the SET button, the up arrow button will change the value of the product consistency setting. This button is used primarily to navigate through the control settings.

3.3 IMPORTANT INFORMATION REGARDING CLEANING AND SANITIZING

Soft serve and shake machines require special consideration when it comes to food safety and proper cleaning and sanitizing.

The following information specifically covers issues for cleaning and sanitizing frozen dessert machines. This information is meant to supplement a comprehensive food safety program.

Soil Materials Associated with Frozen Dessert Machines

MILKFAT/BUTTERFAT – As components of ice-cream/frozen custard mix, these soils will accumulate on the interior surfaces of the machine and its parts. Fats are difficult to remove and help attribute to milkstone buildup.

MILKSTONE – Is a white/gray film that forms on equipment and utensils that come in contact with dairy products. These films will accumulate slowly on surfaces because of ineffective cleaning, use of hard water, or both. Milkstone is usually a porous deposit, which will harbor microbial contaminants and eventually defy sanitizing efforts.

Once milkstone has formed, it is very difficult to remove. Without using the correct product and procedure, it is nearly impossible to remove a thick layer of milkstone.

(NOTE: general-purpose cleaners DO NOT remove milkstone.) This can lead to high bacteria counts and a food safety dilemma.

IT IS BEST TO CONTROL MILKSTONE ON A DAILY BASIS BEFORE IT CAN BECOME A SIGNIFICANT FOOD SAFETY PROBLEM.

In addition to food safety, milkstone can cause premature wear to machine parts which can add to costs for replacement parts or possibly more expensive repairs if worn machine parts are not replaced once they have become excessively worn.

Important Differences Between Cleaning and Sanitizing CLEANING vs. SANITIZING

It is important to distinguish between cleaning and sanitizing. Although these terms may sound synonymous, they are not. BOTH are required for adequate food safety and proper machine maintenance.

CLEANING

- Is the removal of soil materials from a surface.
- Is a prerequisite for effective sanitizing.

NOTE

An UNCLEAN surface will harbor bacteria that can defy sanitizing efforts.

Bacteria can develop and resist sanitizing efforts within a layer of soil material (milkstone). Thorough cleaning procedures that involve milkstone removal are critical for operators of frozen dessert machines.

SANITIZING

- Kills bacteria.
- Can be effective on clean surfaces only.

NOTE

Using a SANITIZER on an unclean surface will not guarantee a clean and safe frozen dessert machine.

Proper Daily Maintenance:

The Only Way to Assure Food Safety and Product Quality

Proper daily maintenance can involve a wide variety of products and procedures. Overall, the products and procedures fall into three separate categories. (Please note that this is a brief overview intended for informational purposes only.)

1. **CLEANING** – This involves draining mix from the machine barrel and rinsing the machine with water. Next, a cleaner is run through the machine. Then, the machine is disassembled and removable parts are taken to the sink for cleaning.
2. **MILKSTONE REMOVAL** – Since almost all cleaners do not have the ability to remove milkstone, the use of a delimer becomes necessary. Although this procedure may not be needed on a daily basis, it will usually follow the cleaning procedure. It requires letting a delimer solution soak in the machine for an extended period of time. Individual parts are also soaked in a deliming solution for an extended period of time (more about delimers in Additional Information).
3. **SANITIZING** – After the machine has been cleaned and contains no milkstone, the machine is reassembled. Then a FDA-approved sanitizing solution is run through the machine to kill bacteria. The machine is then ready for food preparation.

As a recommended cleaner and sanitizer for your frozen dessert machine, STERA-SHEEN has proven to be one of the best daily maintenance products for:

- **CLEANING** – Thorough removal of all solids including butterfat and milk fat.
- **MILKSTONE REMOVAL** – Complete removal of milkstone.
- **SANITIZING** – FDA-approved no rinse sanitizer for food contact surfaces.

Additional Information

THE USE OF DELIMERS

A delimer is a strong acid that has the ability to dissolve milkstone. This type of chemical may become necessary once high levels of milkstone have developed. While these products are very effective for removing HIGH levels of milkstone, they are not ideal for two reasons:

1. **PRODUCT SAFETY** – Strong acids are dangerous chemicals. Carefully follow safety instructions provided with delimer products.
2. **MACHINE DAMAGE** – Strong acids will attack metal and rubber causing premature wear of parts. The use of a delimer needs to be closely monitored to avoid damage to machine surfaces and parts.

With proper daily use of STERA-SHEEN or it's equivalent, there is no need for the use of a DELIMER.

DO NOT USE BLEACH

- **BLEACH HAS ABSOLUTELY NO CLEANING PROPERTIES.**
- **BLEACH IS CORROSIVE.** It can and will damage components of the machine causing premature wear and metal corrosion.

GENERAL PURPOSE CLEANERS

General purpose cleaners do not have the ability to remove milkstone. Milkstone will become a problem if not remedied with additional products and procedures.

THE USE OF CHLORINE TEST STRIPS

“Test strips” are used to determine concentrations of active chlorine in sanitizing solutions. To use the strips, tear off a small portion and submerge it into the sanitizing solution. Then, compare the color change to the color key on the side of the test strip dispenser to determine the approximate chlorine concentration.

WARNING

Moving machinery can grab, mangle and dismember. Place the Main Freezer Power OFF/ON switch in the OFF position before disassembling for cleaning or servicing. Placing the Main Freezer Power OFF/ON switch in the ON position during cleaning or servicing may result in serious personal injury.

The ideal concentration of chlorine needs to be 100 ppm (as stated by the FDA).

NOTE

Follow the directions on the container for proper concentration.

There are two main factors that contribute to falling chlorine concentrations in a sanitizing solution.

1. **PRODUCT USE** – As the chlorine in the solution is being used, chlorine concentrations fall.
2. **TIME** – As time passes, small amounts of chlorine “evaporate” from the solution. (That is why you can smell it.)

Sanitizing solutions should not be allowed to fall below 100 ppm chlorine. New solutions should be mixed once old solutions become ineffective.

3.4 DISASSEMBLY OF MACHINE PARTS

Before using the machine for the first time, complete machine disassembly, cleaning and sanitizing procedures will need to be followed. Routine cleaning intervals and procedures must comply with the local and state health codes. Inspection for worn or broken parts should be made at every disassembly of the machine. All worn or broken parts should be replaced to ensure safety to both the operator and the customer and to maintain good machine performance and a quality product. A normal wear part is the auger flight (see Figure 3-3). Auger flights need to be replaced before the wear line is no longer visible.

To disassemble the machine, refer to the following steps:

A. Disassembly Of Front Door

1. Remove the front door by turning off the circular knobs and then pulling the front door off the studs.
2. Remove the air bleed valve by unscrewing the knob while holding the valve stem from behind (Fig. 3-4). Remove the compression spring and push air bleed valve through the rear of the front door.



Figure 3-3 Auger Flight Wear

- Remove the spigots through the bottom of the front door. Remove all o-rings from spigots and air bleed valve.

B. Disassembly Of Auger

- Remove the front auger support by pulling it straight out of the machine barrel.
- Remove the plastic bearing from the front auger support.

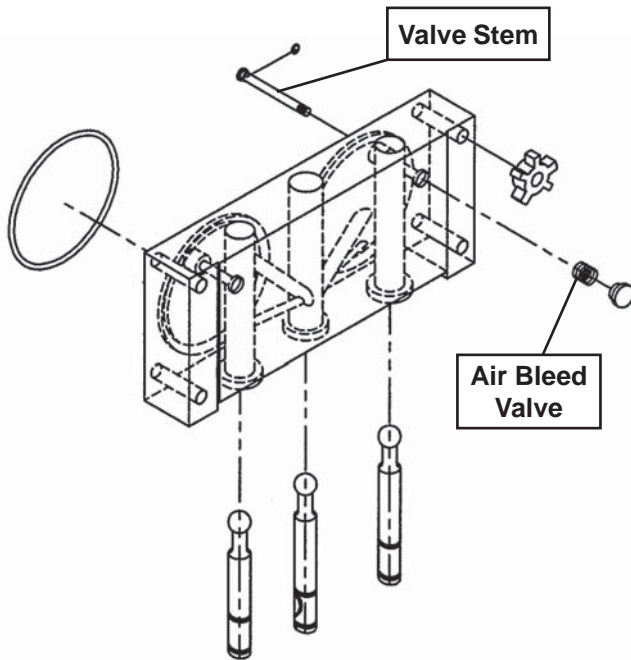

Figure 3-4 Front Door Disassembly

- Remove the auger by pulling slowly and rotating out of the machine barrel. As the auger is withdrawn, remove each plastic flight and spring from the auger (Fig. 3-5). Be careful not to scratch inside of machine barrel when removing flights or auger. Remove the spring from each auger flight.
- Keep the rear of the auger tipped up once it is clear of the machine barrel.
- Wipe spline lubricant off of the hex end of auger with a paper towel. Remove the rear seal assembly (Fig. 3-6).



Figure 3-5 Auger Flight Removal

3.5 CLEANING DISASSEMBLED PARTS

Disassembled machine parts require complete cleaning, sanitizing and air drying before assembling. Local and state health codes will dictate the procedure required. Some state health codes require a four sink process (pre-wash, wash, rinse, sanitize, air dry), while others require a three sink process (without the pre-wash step). The following procedures are a general guideline only. Consult your local and state health codes for procedures required in your location.

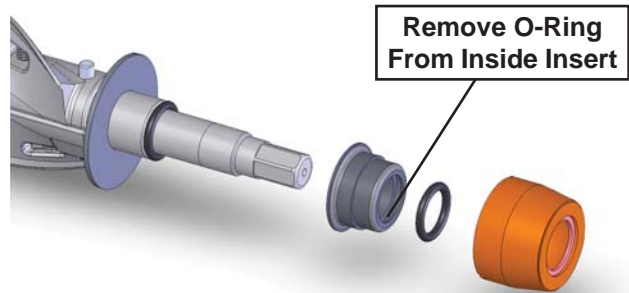

Figure 3-6 Rear Seal Removal

- To clean the machine parts disassemble all parts. (Refer to Section 3.4 for the disassembly of machine parts.)
- Place all front door and auger parts in clean 90° to 110°F (32°C to 43°C) water and wash thoroughly (four sink procedure only).
- Place all parts in 90° to 110°F (32°C to 43°C) , mild detergent water and wash thoroughly.
- Rinse all parts with clean 90° to 110°F (32°C to 43°C) water.
- Sanitize all machine parts following procedures outlined below.

3.6 SANITIZING MACHINE PARTS

- Use a sanitizer mixed according to manufacturer's instructions to provide a 100 parts per million strength solution. Mix sanitizer in quantities of no less than 2 gallons of 90° to 110°F (32°C to 43°C) water. Allow the sanitizer to contact the surfaces to be sanitized for 5 minutes. Any sanitizer must be used only in accordance with the manufacturer's instructions.
- Place all parts in the sanitizing solution for 5 minutes, then remove and let air dry completely before assembling in machine.

3.7 CLEANING THE MACHINE

The exterior should be kept clean at all times to preserve the lustre of the stainless steel. A high grade of stainless steel has been used on the machine to ease cleanup. To remove spilled or dried mix, simply wash the exterior with 90° to 110°F (32°C to 43°C), soapy water and wipe dry.

Do not use highly abrasive materials as they will mar the finish. A mild alkaline cleaner is recommended. Use a soft cloth or sponge to apply the cleaner. For best results, wipe in the direction of the grain of the steel.

- A. Clean the rear seal surface from inside of the machine barrel.
- B. Using this sanitizing solution and the large barrel brush provided, sanitize the barrel by dipping the

CAUTION
Risk of Product Damage Do no use acid cleaners, strong caustic compounds or abrasive materials to clean any part of the freezer exterior or plastic parts.

brush in the sanitizing solution and brushing the inside of the barrel.

- C. Remove the rear drip tray by pulling from side panel. Clean and replace drip tray.

3.8 ASSEMBLING MACHINE

To assemble the machine parts, refer to the following steps:

NOTICE

Petrol-Gel sanitary lubricant or equivalent must be used when lubrication of machine parts is specified.

NOTICE

The United States Department of Agriculture and the Food and Drug Administration require that lubricants used on food processing equipment be certified for this use. Use Lubricants only in accordance with the manufacturer's instructions.

- A. Assemble all o-rings onto parts dry, without lubrication. Then apply a thin film of sanitary lubrication to exposed surfaces of the o-rings.
- B. Lubricate rear seal area on auger shaft with a thin layer of sanitary lubricant. Install the rear seal o-ring. Lubricate outside of rear seal o-ring with sanitary lubricant.
- C. Install the stainless steel rear seal adapter into the rear seal dry (without lubricant). Lubricate the inside surface of the rear seal adapter, including the adapter o-ring, and install it onto the auger shaft. DO NOT lubricate the outside of the rear seal adapter (see Figure 3-7).

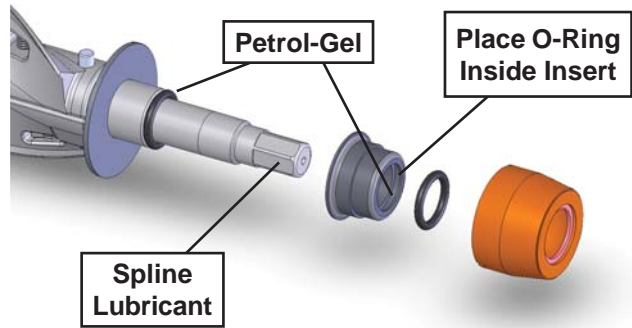

Figure 3-7 Rear Seal Lubrication

- D. Lubricate the hex drive end of auger with a small amount of spline lubricant. A small container of the lubricant is shipped with the machine.
- E. Screw the springs onto the studs in plastic flights. Spring must be screwed into the flights completely to provide proper tension (see Figure 3-8).
- F. Install the two plastic flights onto rear of the auger and insert part way into machine barrel.



Figure 3-8 Spring Installation

- G. Install the remaining plastic flights, push the auger into the machine barrel and rotate slowly until the auger engages the drive shaft.
- H. Apply a thin film of sanitary lubricant to the inside and outside of the front auger support bearing, then place on the front of the auger. Assemble the front auger support onto the auger bearing.

NOTE

Position the front support on auger so legs do not interfere with the pin on the back of the front door assembly. Front door must push auger in slightly when it is being tightened to prevent the rear seal from leaking.

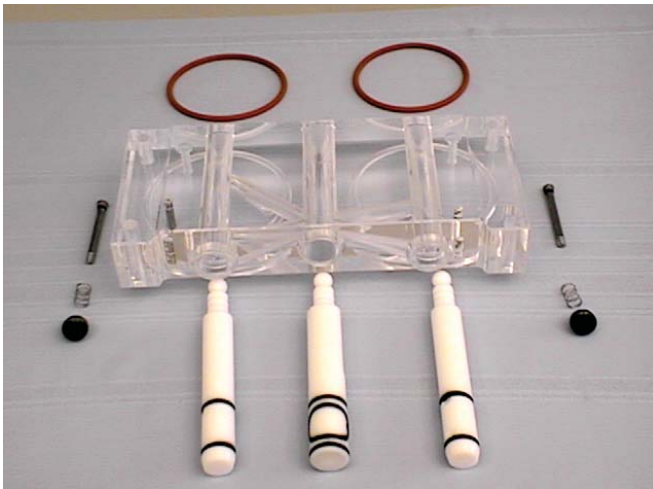

Figure 3-9 Front Door Assembly

- I. Install the spigots through the bottom of the front door (see Figure 3-9).
- J. Assemble the air bleed valve o-ring onto the air bleed valves. Position the o-ring in groove close to the wide part. Apply a thin film of sanitary lubricant to the o-rings.
- K. Insert the air bleed valves from the back of the front door. Install compression springs onto air bleed valves then screw knobs on finger tight.
- L. Apply a thin film of sanitary lubricant to the door seal o-rings, and fit into the grooves on the rear of the front door.
- M. Place the front door assembly on the mounting studs and push front door against the machine carefully.
- N. Secure front door assembly by placing the knobs on the studs and alternately tighten opposite corners until finger tight only. Do not overtighten. Proper o-ring seal can be observed through the transparent front door.

3.9 SANITIZING

Sanitizing must be done after the machine is clean and just before the machine is filled with mix. Sanitizing the night before is not effective. However, you should always clean the machine and parts after using it.

! WARNING

The United States Department of Agriculture and the Food and Drug Administration require that all cleaning and sanitizing solutions used with food processing equipment be certified for this use.

When sanitizing the machine, refer to local sanitary regulations for applicable codes and recommended sanitizing products and procedures. The frequency of sanitizing must comply with local health regulations. Mix sanitizer according to manufacturer's instructions to provide a 100 parts per million strength solution. Mix sanitizer in quantities of no less than 2 gallons of 90°F to 110°F (32°C to

CAUTION

Risk of Product Damage

Avoid prolonged contact of sanitizer with machine parts. Prolonged contact of sanitizer with machine may cause corrosion of stainless steel parts.

43°C) water. Allow sanitizer to contact the surfaces to be sanitized for 5 minutes. Any sanitizer must be used only in accordance with the manufacturer's instructions.

- A. Prepare 3 gallons of sanitizing solution following manufacturer's instructions. Pour into clean container and place container into the cabinet.
- B. Place the mix pump switch in the ON position and open air bleed valve on the front door by pushing valve in and holding (see Figure 3-10).
- C. Let sanitizing solution fill the machine barrel to air bleed valve, then close the valve by pulling out to lock in place.

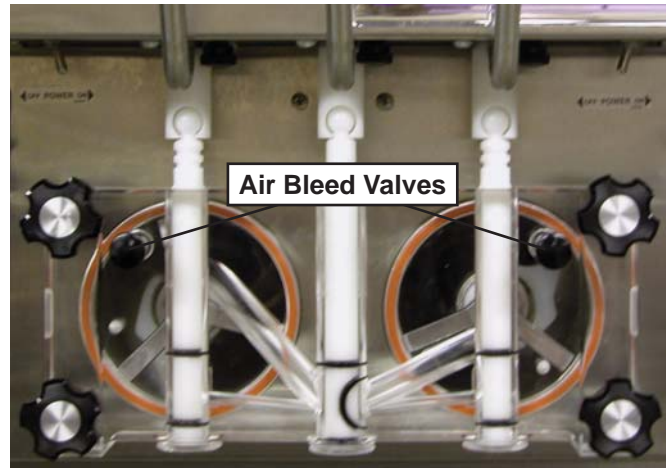

Figure 3-10. Air Bleed Valves



Figure 3-11 Clean Control

- D. Place the Main Power OFF/ON and Freezing Cylinder OFF/ON switches in the ON position then press the CLEAN button (Fig. 3-11).
- E. Check for leaks when the freezing cylinder is first pressurized with sanitizing solution.
 - 1. Check for leaks at the front door seals.
 - 2. Check the drain located above the center of the Drip Tray for leaks coming from the rear of the Rear Auger Seal.
 - 3. Check inside the cab unit for leaks at hose connections.
- F. Using a sanitized soft bristle brush or equivalent, dipped in sanitizing solution, clean mix container.
- G. After five minutes, open spigot to expel sanitizing solution. Drain all solution from machine using all three spigots.
- H. When solution has drained, press the CLEAN button to stop the auger and place the Main Power OFF/ON and Freezing Cylinder OFF/ON switches in the OFF position. Allow the machine barrel to drain completely.

The machine is now sanitized and ready for adding mix.

3.10 INITIAL FREEZE DOWN AND OPERATION

Every Stoelting soft serve machine needs to be set on site. The following adjustment will provide optimal product consistency while prolonging product life.

NOTE

The machine is designed for correct operation in ambient temperatures between 50°F and 110°F. Temperatures out of that range may cause refrigeration problems and product quality issues.

NOTE

Do the initial adjustment for the left side and right side separately.

A. ADDING MIX

1. Sanitize immediately before use.
2. Make sure the Freezing Cylinder OFF/ON switch is in the OFF position.
3. Fill the storage containers in the cab with at least 2.5 gallons of mix.
4. Attach the mix inlet probes to the container and place the containers in the refrigerated cab.
5. Place the mix pump switch in the ON position (Fig. 3-12).

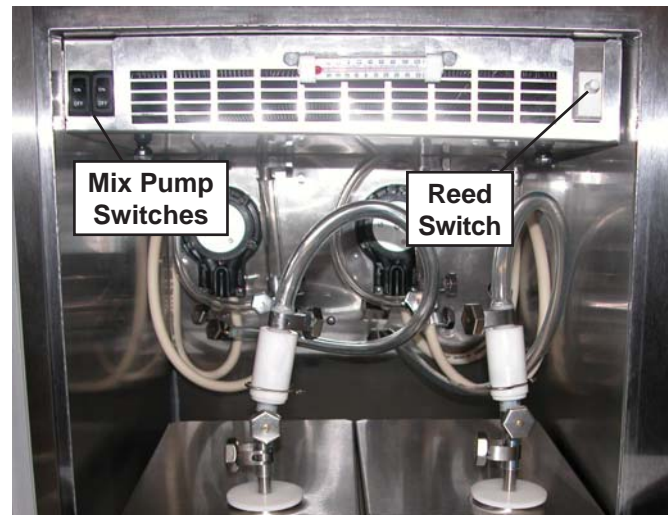

Figure 3-12 Refrigerated Cabinet

6. Place a container under the spigot and open the spigot to allow the mix to flush out about 8 ounces (0.23 liters) of sanitizing solution and liquid mix. Close the spigot.
7. Open the air bleed valve on the front door by pressing and holding (Fig. 3-13). Hold the valve open until the mix level in the freezing cylinder is 1/2" from the air bleed valve.

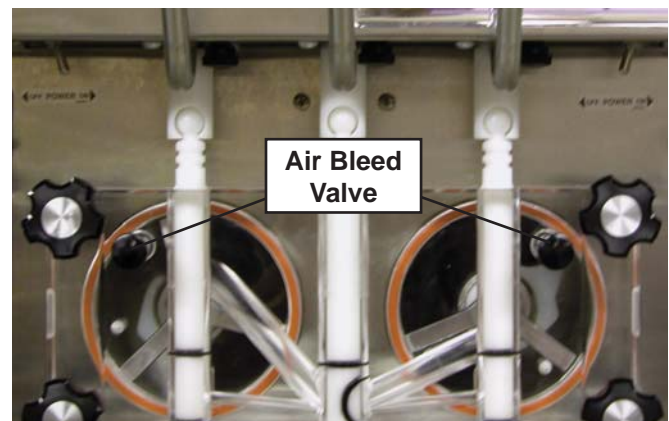

Figure 3-13 Air Bleed Valves

B. PREPARING INTELLITEC CONTROL

8. On the IntelliTec control, press and hold SEL button for 8 seconds. While still holding the SEL button, press the up arrow (↑) button. The LCD will read "DISPLAY".
9. Press the left arrow (←) button once. The display will read "BASIC".
10. Press the up arrow (↑) button once. The display will read "CutOut amps".
11. Press the SET button. A cursor will start blinking under the far right digit.
12. Change the value to 8.0. Press the left arrow (←) button to move the cursor. Press the up arrow (↑) button to increase the digit. When a digit reaches 9, pressing the up arrow (↑) button again will change the value to 0.
13. After entering 8.0, press SET to save this value. The LCD will read "CutOut Set -- OK".
14. Press the SEL button. The LCD will read "CutOut amps 8.0".
15. Press the SEL button twice. The LCD will read "DISPLAY".
16. Press the up arrow (↑) button to navigate to the "°F" and "amps" readings.

C. INITIAL FREEZE DOWN

17. Place the Freezing Cylinder OFF/ON switch in the ON position.
18. Press the PUSH TO FREEZE button.

NOTE

After the drive motor starts, there is a 3-second delay before the compressor starts.

19. As the product freezes, the "amps" value on the display will increase. When it reaches 2.6A, open the spigot, take a 6-8 ounce sample and measure the temperature. For most soft serve mixes, the desired temperature is between 19.0°F and 19.5°F.
20. Draw samples at every increase of 0.2A until reaching the desired consistency and temperature.

NOTE

Show the sample to the customer and make sure it meets their required consistency and temperature.

21. Record the "amps" value.
22. Place the Freezing Cylinder OFF/ON switch in the OFF position.

D. ADJUSTING INTELLITEC CONTROL

23. Press the SEL button. The display will read "DISPLAY".
24. Press the left arrow (←) button once. The display will read "BASIC".

25. Press the up arrow (↑) button once. The display will read "CutOut amps".
26. Change the value to the recorded value by pressing the SET button. A cursor will start blinking under the far right digit.
27. Press the left arrow (←) button to move the cursor. Press the up arrow (↑) button to increase the digit. When a digit reaches 9, pressing the up arrow (↑) button again will change the value to 0.
28. Press the SET button to save the value. The LCD will read "CutOut Set -- OK".
29. Press the SEL button. The LCD will read "CutOut amps" along with the programmed value from the previous step.
30. Press the SEL button three times. The LCD will read "EXITMENU".
31. Press the up arrow (↑) button to exit the menu.
32. Adjustment to the control is completed. If the adjustment was done for the left side, restart the procedure for the right side.

E. SERVING PRODUCT

33. Place the Freezing Cylinder OFF/ON switch in the ON position.
34. Press the PUSH TO FREEZE button.
35. When the product is at 75% consistency, the display will read "SERVE".
36. For normal dispensing, move the spigot handle fully open.
37. The machine dispenses product at a reasonable draw rate. If the machine is overdrawn, the result is a soft product or a product that will not dispense at all. If this occurs, allow the machine to run for approximately 30 seconds before dispensing more product. Spigot rate adjusters are located under the header panel, to the immediate right of each spigot handle. Turning the spigot rate adjuster counterclockwise will decrease the dispense rate.
38. Do not operate the machine when the MIX LOW message is displayed. Refill the mix container immediately.

NOTE

The machine has a standby and sleep mode. After a preset number of freezing cycles, it will enter the standby mode (followed by sleep mode) and remain there until someone draws product or presses the PUSH TO FREEZE button. In the sleep mode, the machine will keep the product below 41°F (7.2°C). Sleep modes do not take the place of cleaning and sanitizing. Federal, State, and local regulatory agencies determine frequency of cleaning and sanitizing.

3.11 NORMAL FREEZE DOWN AND OPERATION

The following section contains the recommended operating procedures for the safe operation of the machine.

1. Sanitize immediately before use.
2. Make sure the Freezing Cylinder OFF/ON switch is in the OFF position.
3. Fill the storage containers in the cab with at least 2.5 gallons of mix.
4. Attach the mix inlet probes to the container and place the containers in the refrigerated cab.
5. Place the mix pump switch in the ON position.
6. Place a container under the spigot and open the spigot to allow the mix to flush out about 8 ounces (0.23 liters) of sanitizing solution and liquid mix. Close the spigot.
7. Open the air bleed valve on the front door by pressing and holding. Hold the valve open until the mix level in the freezing cylinder is 1/2" from the air bleed valve.
8. Place the Freezing Cylinder OFF/ON switch in the ON position.

NOTE

After the drive motor starts, there is a 3-second delay before the compressor starts.

9. Press the PUSH TO FREEZE button.
10. When the product is at 75% consistency, the display will read "SERVE".
11. For normal dispensing, move the spigot handle fully open.
12. The machine dispenses product at a reasonable draw rate. If the machine is overdrawn, the result is a soft product or a product that will not dispense at all. If this occurs, allow the machine to run for approximately 30 seconds before dispensing more product. Spigot rate adjusters are located under the header panel, to the immediate right of each spigot handle (Fig. 3-14). Turning the spigot rate adjuster counterclockwise will decrease the dispense rate.

CAUTION

Risk of Product Damage

Mix pump hose must be repositioned every 800 gallons of mix served or 2 weeks. Failure to comply will result in reduced mix pump liquid capacity, dispense stoppage, popping, and possible mix pump hose leakage. Hose leakage may damage the pump roller assembly and void the factory warranty

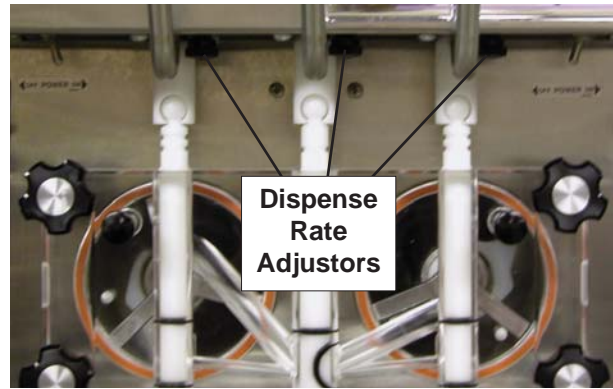

Figure 3-14 Dispensing Product

13. Do not operate the machine when the MIX LOW message is displayed or with less than 1-3/4" (4.4 cm) of mix in the hopper. Refill the hopper immediately.

NOTE

The machine has a standby and sleep mode. After a preset number of freezing cycles, it will enter the standby mode (followed by sleep mode) and remain there until someone draws product or presses the PUSH TO FREEZE button. In the sleep mode, the machine will keep the product below 41°F (5°C). Sleep modes do not take the place of cleaning and sanitizing. Federal, State, and local regulatory agencies determine frequency of cleaning and sanitizing.

3.12 MIX INFORMATION

Mix can vary considerably from one manufacturer to another. Differences in the amount of butterfat content and quantity and quality of other ingredients have a direct bearing on the finished frozen product. A change in machine performance that cannot be explained by a technical problem may be related to the mix.

Proper product serving temperature varies from one manufacturer's mix to another. Mixes should provide a satisfactory product in the 17° to 20°F (-7° to -6°C) range. Diet and low-carb mixes typically freeze to proper consistency at higher temperatures.

When checking the temperature, stir the thermometer in the frozen product to read the true temperature.

Old mix, or mix that has been stored at too high a temperature, can result in a finished product that is unsatisfactory. To retard bacteria growth in dairy based mixes, the best storage temperature range is between 36° to 40°F (2.2° to 4.4° C).

3.13 OPERATION OF MIX PUMP

The mix pump switches are located in the upper left hand corner, inside the refrigerated cabinet. When a pump switch is placed in the ON position, the mix pump motor will start pumping mix into the machine cylinder. When the set pressure is reached, the mix pump will shut off automatically. When the switch is placed in the OFF position, the mix pump will be inoperative.

NOTE

The mix pump motor is equipped with an internal overload that will “trip”, disabling the pump when the motor is overloaded. Consult the trouble shooting section for corrective information. The internal overload will automatically reset after cooling. If the condition continues, contact a qualified service person.

- A. Mix Operation: The peristaltic mix pump contains one continuous mix pump hose. When looking at the face of the peristaltic mix pump, the left side of the hose is the suction or pickup. The right side of the hose is the discharge. Mix is drawn up the suction side of the hose and transferred through the discharge side to the machine (see Figure 3-15).

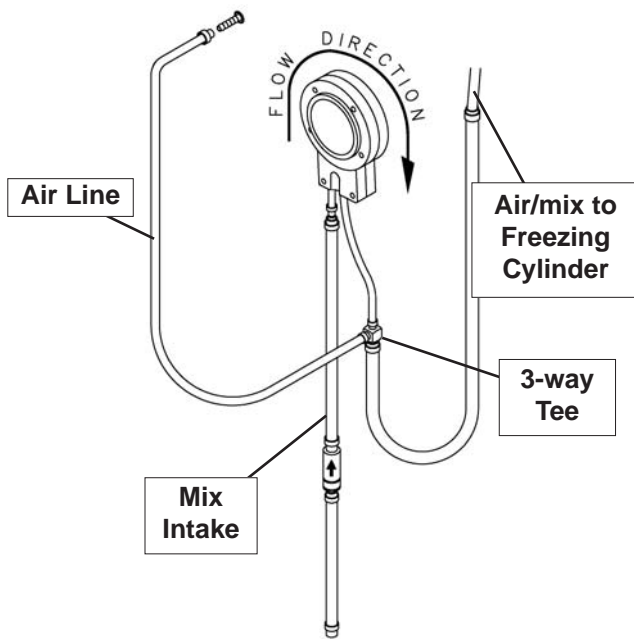

Figure 3-15 Mix Pump Hose Routing

- B. Air Operation: The air compressor operates whenever the peristaltic mix pump is running. Air enters through a check valve on the piston downstroke. The air is discharged through a second check valve, on the piston upstroke. The air and mix join at the tee and then travel to the machine.
- C. The overrun adjustment is preset at the factory. If an adjustment becomes necessary, refer to Section 4.

NOTICE

Any cleaning procedure must always be followed by sanitizing before filling machine with mix. (Refer to section 3.3)

3.14 MIX PUMP CLEANING

The mix pump is approved for CIP (clean in place) and is thoroughly cleaned as cleaning solutions are pumped through the machine. We recommend completely disassembling the pump and disconnecting tubing every 14 days for inspection of parts to confirm the CIP has been properly performed. If any residue is detected clean or replace those parts as outlined below.

- A. Place the Main Power OFF/ON and Freezing Cylinder OFF/ON switches ON position and press the CLEAN button. Allow the auger to agitate for 5 to 10 minutes.
- B. Remove suction tube from mix container. Draw off the mix remaining in machine barrel.
- C. Pump 2 gallons (7.5 liters) of potable water through machine until water at spigot is free of mix.
- D. Pump 2 gallons (7.5 liters) of 90° to 110°F (32°C to 43°C) detergent solution water through machine. The use of soft water is recommended, along with dishwashing detergents such as “Joy,” “Dawn,” or equivalent.
- E. Place mix pump switch in OFF position. Open spigot to relieve remaining pressure.
- F. Press the CLEAN button to stop the auger and place the Main Power OFF/ON and Freezing Cylinder OFF/ON switches in the OFF position.

3.15 DISASSEMBLY AND INSPECTION OF REMOVABLE PARTS

Inspection of removable parts should be made whenever maintenance is performed or pump requires disassembly.

! WARNING

Hazardous Moving Parts

Revolving pump head can grab, mangle, and cause serious crushing injury. The Main Power OFF/ON switch must be placed in the OFF position for cleaning and power must be disconnected when disassembling or servicing.

NOTE

If the mix lines or air line is difficult to remove, soften tubing with a rag soaked in hot water. Hose connections may be sprayed with Haynes Sanitary Lubricant for ease of removal. Do not loosen or remove the mix pump cover wing nuts. Maintain the mix pump hose in its operational condition.

CAUTION

System Under Pressure

Never disconnect hoses from machine or pump without first opening spigot to relieve pressure.

- A. Loosen clamp and remove air hose from pump compressor.
- B. Loosen clamp and disconnect mix pump hose. Remove the pickup hose, mix check valve and pickup hose adapter (and bag adapter if applicable) as an assembly from mix container.
- C. Completely disassemble both hose assemblies and check valve. Place hoses, tee, check valve assembly, and pickup hose adapter in 90° to 110°F (32°C to 43°C), mild detergent water and wash thoroughly. Use soft bristle brushes to clean inside of fittings. Rinse all parts in clean 90° to 110°F (32°C to 43°C) water (see Figure 3-16 and 3-17).



Figure 3-16 Removable Parts



Figure 3-17 Removable Parts for optional BCS

- D. Carefully inspect each part for wear or damage. Replace worn or damaged parts.
- E. Wash feed tube and air tube with 90° to 110°F detergent water and brushes provided. Rinse with clean, 90° to 110°F water (See Figure 3-18 and 3-19).



Figure 3-18 Cleaning Air Tube



Figure 3-19 Cleaning Feed Tube

- F. Prepare two gallons (7.5 liters) of sanitizing solution using a USDA certified grade sanitizing solution. Sanitize all removed parts, then air dry.
- G. Check Hose Service Record decal to determine if hose reposition or replacement is required at this time.
- H. Reassemble both hose assemblies per the diagram located on the inside of the cab door. Reconnect assemblies to the pump and discharge hose, using the clamps. (Refer to Section 2.5 Mix Pump).
- I. Sanitize assembled machine as per instructions outlined in Section 3.9.

SECTION 4 MAINTENANCE AND ADJUSTMENTS

4.1 MACHINE ADJUSTMENT

This section is intended to provide maintenance personnel with a general understanding of the machine adjustments. It is recommended that any adjustments in this section be made by a qualified person.

4.2 PRODUCT CONSISTENCY ADJUSTMENT

The operator can adjust product consistency by modifying the Fine Adjustment setting on the membrane switch. This is the only adjustment that can be made by the operator without using a pass code key sequence. Product consistency fine adjustment allows a 0.4 amp maximum adjustment to the drive motor amp draw cutout. Increasing this setting will increase the drive motor amperage cutout and increase product consistency. Follow the instructions below to make fine adjustments to product consistency.

- A. Place the Main Freezer Power switch in the ON position.
- B. Press the SET button on the Control Panel once. Fine Adj will appear on the LCD screen.
- C. Press the up arrow button (↑) until the desired consistency setting is displayed. The higher the number, the firmer the product consistency. The control may be set from 1 to 9. The value increases by 1 each time the up arrow button is pressed. After the value reaches 9, numbering restarts at 0. The 0 setting cannot be set.
- D. Press the SET button once to save the setting and return to the current mode display.

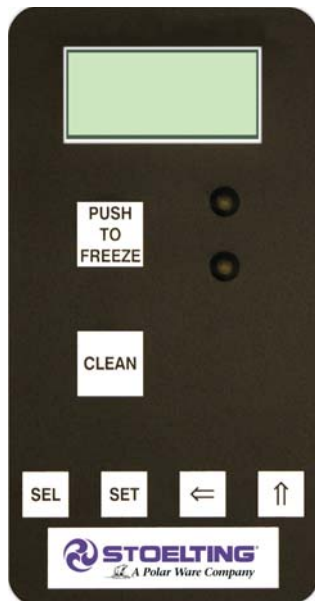

Figure 4-1 Caption

4.3 LOCKING THE CONTROL PANEL

The IntelliTec control has a tamper proof mode to prevent unauthorized use. When set, all buttons on the control panel are disabled. Follow the instructions below to lock the control panel

- A. Press and hold the PUSH TO FREEZE button for at least 5 seconds.
- B. While still holding the PUSH TO FREEZE button, press the CLEAN button once.
- C. Release both buttons. An asterisk (*) will appear on the bottom line of the display, indicating that the control is in the lock out mode.

NOTE:

Repeat steps A, B, and C to unlock the control panel.

4.4 OBTAINING READINGS AND MODIFYING SETTINGS (SERVICE PERSONNEL ONLY)

Readings and settings on the IntelliTec control are accessed through the IntelliTec control menu settings. Locating machine readings and system function settings are done using the up arrow (↑) and left arrow (←) buttons on the membrane switch. A printed IntelliTec Menu Settings sheet is located in the information pouch behind the header panel.

IntelliTec Control Readings

To obtain machine readings, locate the value on the machine's menu settings sheet and follow the steps below.

- A. Press and hold the SEL button for 8 seconds. While still holding the SEL button, press the up arrow button (↑). The LCD screen will read DISPLAY.
- B. Release both buttons.
- C. Press the up arrow button (↑) to navigate to the correct reading under DISPLAY or press the left arrow (←) button to navigate to the ERRCODES menu.
- D. Press the up arrow (↑) and left arrow (←) buttons to navigate through the rest of the readings as needed.
- E. When all readings have been obtained, press the up arrow button (↑) from ExitMenu to return to the current mode display.

Modifying Control Settings

To change the value of a system function, locate the function on the IntelliTec Settings Menu and follow the steps below.

IMPORTANT:

Before making changes to any settings, record the original values. If the setting changes do not achieve desired results, return settings to their original values.

- A. Press and hold the SEL button for 8 seconds. While still holding the SEL button, press the up arrow button (↑). The LCD Screen will read DISPLAY.
- B. Release both buttons.
- C. Press the left arrow button (←) to get to the correct menu (Basic, Advanced, or Storage).
- D. Press the up arrow button (↑) to navigate to the value that needs to be changed.
- E. Press the SET button to enter the edit mode.
- F. Press the up arrow button (↑) to change the setting.
- G. Press the SET button to save the setting and exit the edit mode.
- H. Press the up arrow (↑) and the left arrow (←) buttons to navigate through the rest of the settings as needed.
- I. When all changes have been completed, press the up arrow button (↑) from ExitMenu to return to the current mode display.

4.5 READINGS (SERVICE PERSONNEL ONLY)

The IntelliTec control continuously monitors and records temperatures, voltages, amps, and error code details. Each reading is beneficial to service personnel when troubleshooting.

DISPLAY READINGS

Following are the readings available under the DISPLAY menu:

Cabinet

The temperature of the cab is constantly monitored by the IntelliTec control.

Cycles (count)

This reading counts down the number of cycles in the current "Serve Mode". The starting value is dependant upon the Cycles setting on the IntelliTec control.

°F and amps

Suction line temperature on the freezing cylinder and drive motor amps are available on the same screen to assist with setup and troubleshooting.

Aux. Temp (°F)

This reading provides the ambient temperature around the IntelliTec control board.

Supply V (VAC)

A calculated input voltage is recorded.

ERROR CODE READINGS

The following details are recorded under the ERRCODES menu for each of the last 25 error codes received:

Err1 (hours)

A numerical count of the last 25 error codes is recorded. When the 26th error has occurred, the earliest error code is erased. A timer also begins when an error occurs. The timer records the number of hours since the error occurred. If power to the machine is interrupted, the timer will stop until power has been restored.

°F and amps

The suction gas temperature on the freezing cylinder and the drive motor amps are recorded at the time of the error.

Aux. Temp (°F)

Ambient temperature of the IntelliTec control board is recorded at the time of the error.

Str (°F)

The storage temperature is recorded at the time of the error.

VAC and Mode

A calculated input voltage and mode at which the error occurred are recorded. Following are descriptions of each mode:

Mode	Description
0	Start of freezing cycle
1	Compressor and drive motor on
2	Stir Cycle
3	Compressor off
4	"Standby Mode"
5	"Sleep 1 Mode"
6	"Sleep 2 Mode"
7	"Clean Mode"
8	Startup
9	Storage only refrigeration
10	Freezing cycle is shut down
11	Door safety switch triggered
12	High pressure cutout

Up Time (hours)

This value is a record of the total time the machine has been in service. If power is interrupted, the timer will stop until power is restored. This timer does not reset.

RUN STATISTICS

In addition to dynamic readings and recorded error code details, the IntelliTec control records rolling averages of run statistics. Following are the readings available under the RUNSTATS menu:

On Times (sec)

The control records the time of each freezing cycle and provides a rolling average.

Off Times (sec)

The control records the time between freezing cycles and provides a rolling average.

Brl. Min (°F)

The lowest average barrel temperature is recorded.

Brl. Max (°F)

The highest average barrel temperature is recorded.

Stor Min (°F)

The lowest average cabinet temperature is recorded.

Stor Max (°F)

The highest average cabinet temperature is recorded.

Power On (hrs)

This value is a record of the time the machine has been in service. If power is interrupted, the timer will reset.

4.6 ADJUSTMENTS (SERVICE PERSONNEL ONLY)

The following adjustments directly affect product consistency and length of time in “Serve Mode”. The default settings have been created using a 5% milkfat soft serve mix and provide optimal product consistency while prolonging product life.

CutOut (amps)

It is recommended to set the CutOut value at initial startup and when changing mix types. Adjustments to this setting directly affect the length of the freezing cycle and indirectly change product consistency. To properly set the CutOut value, during startup navigate to the “°F” and “amps” values under the Display menu (Refer to Section 4.4), start the machine and freeze the product to the desired consistency. Monitor consistency by taking a 6 ounce sample at each change of the “amps” display. When the desired consistency has been reached, record the temperature and amps, and change the CutOut value to the recorded amps value.

Cut In T (°F)

After the consistency value has been determined, the Cut In T value can be adjusted. The Cut In T is the temperature of the refrigerant gas coming out of the freezing cylinder. Changing this setting changes the temperature at which the freezing cycle starts. Decreasing the Cut In T decreases the amount of off time. This creates a greater chance of product breakdown by stirring the product often. Increasing the Cut In T increases the amount of off time, which may cause heat shock within the product.

Cycles (count)

This setting determines the number of freezing cycles during “Serve Mode”. Increasing the value will increase the total time in “Serve Mode”. Factory default is 20 cycles, which results in “Serve Mode” lasting about 2-1/2 hours without the PUSH TO FREEZE button being pressed or a spigot handle being pulled. If the PUSH TO FREEZE button is pressed or the spigot handle is pulled at any time during “Serve Mode”, the Cycles count will reset.

4.7 OTHER SETTINGS (SERVICE PERSONNEL ONLY)

Changing any setting on the IntelliTec control will alter machine operation and affect the product temperature, consistency, or life. Refer to the IntelliTec Control System Settings sheet located in the information pouch behind the header panel of the machine. If any of the following settings on the IntelliTec control differ from the System Settings sheet, it is recommended to return those settings to factory defaults.

Stir On (sec)

Adjustments to this setting affect the amount of time the auger rotates in the stir cycle. The stir cycle occurs in “Serve Mode”, “Standby Mode”, and “Sleep 2 Mode”.

Stir Off (sec)

Adjustments to this setting affect the time between stir cycles. The stir cycle occurs in “Serve Mode”, “Standby Mode”, and “Sleep 2 Mode”.

On Time (sec)

Increasing this value will increase the length of the freezing cycle during “Standby Mode” and result in a decrease of average product temperature in the barrel.

Off Time (sec)

Increasing this value will increase the time between freezing cycles in “Standby Mode” and result in an increase of product temperature in the barrel.

Stb Time (sec)

This setting determines the total amount of time in “Standby Mode”.

SI1DrvOn (sec)

Adjustments to this setting affect the amount of time the auger rotates in the stir cycle. This stir cycle only occurs in “Sleep 1 Mode”.

SI1DrOff (sec)

Adjustments to this setting affect the time between stir cycles. The stir cycle only occurs in “Sleep 1 Mode”.

SI2CutIn (°F)

Changing this setting affects the temperature at which the freezing cycle starts in “Sleep 2 Mode”.

SI2CtOut (°F)

Changing this setting affects the temperature at which the freezing cycle stops in “Sleep 2 Mode”.

DftOffTm (sec)

In “Serve Mode”, this value determines the maximum time without a freezing cycle. If this value is met, a freezing cycle will start. In the event of a freezing cylinder temperature sensor failure, this value affects the amount of time between freezing cycles during “Serve Mode”.

Refriger

This setting changes how the control handles the storage refrigeration cycle. The setting for the left control is “Cabinet” and “None” on the right control.

CabCutIn (°F)

If the Refriger value is set to Cabinet, this setting determines the temperature at which the refrigeration cycle starts. If None, 1 Hopper, or 2 Hopper is selected for the Refriger setting, CabCutIn will not be shown on the IntelliTec menu.

CabCtOut (°F)

If the Refriger value is set to Cabinet, this setting determines the temperature at which the refrigeration cycle stops. If None, 1 Hopper, or 2 Hopper is selected for the Refriger setting, CabCtOut will not be shown on the IntelliTec menu.

Cab Off

If the Refriger value is set to Cabinet and the temperature sensor in the cabinet fails, this setting determines the time between refrigeration cycles. If None, 1 Hopper, or 2 Hopper is selected for the Refriger setting, Cab Off will not be shown on the IntelliTec menu.

Cab On

If the Refriger value is set to Cabinet and the temperature sensor in the cabinet fails, this setting determines the length of the refrigeration cycle. If None, 1 Hopper, or 2 Hopper is selected for the Refriger setting, Cab On will not be shown on the IntelliTec menu.

4.8 OVERRUN ADJUSTMENT

The product, when served, is a combination of air and mix. Overrun is a measure of the amount of air blended into the mix.

Overrun can be expressed in terms of the amount of weight loss for a given volume. For example, if a pint of liquid mix weighs 18 ounces and a pint of frozen product with air added weighs 12 ounces, the overrun is said to be 50 percent: $18 \text{ oz.} - 12 \text{ oz.} = 6 \text{ oz.}$, $(6/12) \times 100 = 50\%$

The overrun can be checked by placing a one pint container on an ice cream scale and zeroing out the scale. Then fill a one pint container with frozen product. The container should be filled over the top and leveled with a straightedge. The product should not contain any air pockets. When weighed on an ice cream scale, one pint of product should weigh 12 to 13 ounces.

The mix pump has been preset at the factory to produce a product with approximately 40% overrun. Because of differences in mix formulation, temperatures and barometric pressure, this figure may vary. It will be necessary for approximately 2 gallons of mix to be pumped through the machine before overrun changes in the product are noticeable.

Overrun is controlled by the length of the air compressor piston stroke within the piston cylinder. Lengthening the stroke within the cylinder will increase overrun. Conversely, shortening the stroke will decrease overrun. To perform an overrun adjustment, refer to the following procedure:

- A. Turn the mix pump switch to the OFF position. Disconnect power sources/circuit breakers.
- B. Remove the back panel from the machine.
- C. On the air compressor side of the pump, locate the long/slender piston rocking arm. The rocking arm downward travel is limited by a stationery cam. On the face of the cam there is an overrun setting indicator plate numbered 3 through 8 and an adjustment knob (Fig. 4-2).

WARNING

Hazardous Voltage

The Main Freezer Power switch must be placed in the OFF position when disassembling for servicing. The machine must be disconnected from electrical supply before removing any access panel. Failure to disconnect power before servicing could result in death or serious injury.

- D. The overrun setting is indicated by a pin.
- E. To adjust overrun, loosen the allen-head screw (located within the center of the adjustment knob) with the 5/32" allen wrench provided. Rotate the adjustment knob counterclockwise to a higher number for higher overrun, or clockwise to a lower number for lower overrun. Each number multiplied by 10 represents the overrun percentage (i.e. setting 4 = 40% overrun).

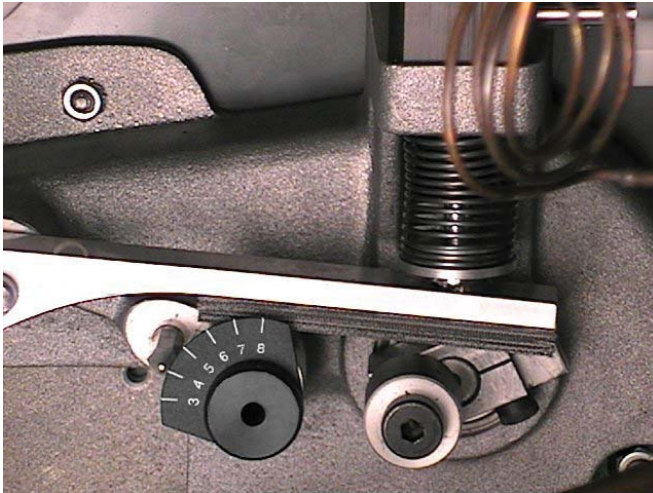

Figure 4-2 Overrun Adjustment

- F. Tighten the allen screw, then place the wrench back in its clip. Replace the lower back panel and secure with the four screws. Turn the mix pump power switch to the ON position.

4.9 MIX PUMP HOSE REPOSITION

Mix pump hose must be repositioned every 800 gallons of mix pumped or every 2 weeks. Failure to reposition the hose will result in reduced mix pump liquid capacity, dispense stoppage, popping, and possible mix pump hose leakage. Follow the steps below to reposition the hose:

- A. Run cleaning solution through pump.
- B. Turn the pump off and relieve any pressure by opening the spigot.
- C. Grasp the pickup hose end of the mix pump hose with one hand and turn the pump on. Pull down on the pickup hose end until 12 to 14 inches of tubing has fed through the pump then turn the pump off (Fig. 4-3).
- D. Loosen the small clamp at the pick-up hose adapter and disconnect the mix pump hose.
- E. Cut 7-1/2 inches off the end of the mix pump hose.
- F. Reconnect the mix pump hose to the adapter.
- G. Continue normal operation. Mix hose will automatically reposition itself with the adapter near the black cover.

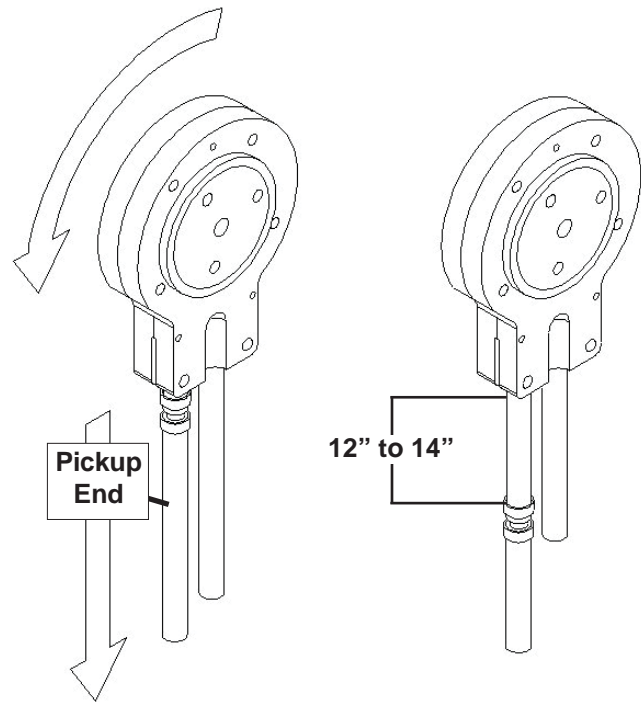

Figure 4-3 Pump Hose Reposition

NOTE

Each hose is long enough for 3 repositions before replacement is required.

4.10 MIX PUMP HOSE REPLACEMENT

Mix pump hose must be replaced when tubing cannot be further repositioned (every four to eight weeks). Failure to comply will result in hose failure and possible pump damage. Follow the steps below to replace the hose:

- A. Run cleaning solution through pump.
- B. Turn the pump off and relieve any pressure by opening the spigot.
- C. Disconnect the mix pump hose at each end.
- D. Grasp the discharge hose end with one hand and turn the pump on. Pull down on the hose until all of the remaining hose is removed from the pump. Turn pump off.
- E. Rotate pump roller assembly so one roller is at the 6:00 position.
- F. Use a brush that fits in the opening and clean the pump roller assembly, first with detergent water and then clear water.
- G. Connect the new mix pump hose to the pickup hose adapter using the small clamp.
- H. Feed one end of the mix pump hose into the pickup hose side (left) of the black cover.

NOTE

Feed the tube into the clamp so the natural curve of the tube is towards the outside of the black cover. This prevents the hose from looping around the black cover twice.

- I. Gently push the hose into the black cover until it begins to feed.
- J. Allow the hose to feed itself through the pump until about 6" (15cm) remains on the entering side.
- K. Turn pump off.
- L. Connect the mix pump hose to the elbow fitting (located on the left side of the mix line manifold) using a small hose clamp. Be careful not to twist the mix hose.
- M. Turn the pump on.
- N. Allow the remaining 6" (15cm) of tubing to feed through the pump until the hose adapter prevents further feeding.
- O. Turn the pump off.

CAUTION

Risk of Product Damage

Air/Mix Tee must remain below the black cover clamp. If the Tee is above the pump, the mix may drain into the air compressor, resulting in pump damage.

- P. Connect the free end of the mix pump hose to the 3-way Tee. When all connections are complete, the 3-way Tee must be lower than the black pump housing.
- Q. The pump is now ready to sanitize.

4.11 CAB TEMPERATURE ADJUSTMENT

Cab temperature is monitored and controlled by two settings on the IntelliTec control: CabCutIn and CabCtOut. The cut in value determines the temperature at which the refrigeration cycle starts. The cut out setting determines when the cycle stops. To change the CabCutIn or CabCtOut, follow the steps below:

- A. Press and hold SEL button for 8 seconds. While still holding the SEL button, press the up arrow button (↑). The LCD Screen will read "Display".
- B. Release both buttons.
- C. Press the left arrow button (←) three (3) times to navigate to the Storage menu.
- D. Press the up arrow button (↑) once to navigate to the CabCutIn value. Record this value.

IMPORTANT:

Before making changes to any settings, record the original values. If the setting changes do not achieve desired results, return settings to their original values.

- E. Press SET button to enter edit mode.
- F. Press the up arrow button (↑) to increase the number to the value required. The value increases by 1 each time the up arrow button (↑) is pressed. After the value reaches 9, numbering restarts at 0.
- G. Press SET button to save the setting and exit the edit mode.
- H. Press the up arrow button (↑) once to navigate to the CabCtOut value. Record this value.
- I. Press SET button to enter edit mode.
- J. Press the up arrow button (↑) to increase the number to the value required. The value increases by 1 each time the up arrow button (↑) is pressed. After the value reaches 9, numbering restarts at 0.
- K. Press SET button to save the setting and exit the edit mode.
- L. Press the up arrow (↑) and left arrow (←) buttons to navigate to ExitMenu.
- M. Press the up arrow button (↑) from ExitMenu to return to the Mode Screen.
- N. Locate the Specification Sheet for F431 Control behind the header panel and record the new values on this sheet.



WARNING

Hazardous Voltage

The Main Freezer Power switch must be placed in the OFF position when disassembling for servicing. The machine must be disconnected from electrical supply before removing any access panel. Failure to disconnect power before servicing could result in death or serious injury.

4.12 DRIVE BELT TENSION ADJUSTMENT

- A. Remove a side panel and the back panel.
- B. Use a Burroughs Belt Tension Gauge to set the tension for the drive belt. Set the belt tension to 40-50 lbs.
- C. If an adjustment is necessary, loosen the four motor plate retaining nuts, adjust belt tension then retighten the four nuts.

NOTE

Belt life will be increased if new drive belts are tightened after two or three weeks of operation.

4.13 CONDENSER CLEANING (AIR-COOLED MACHINES)

The condenser requires periodic cleaning. To clean the condenser, refer to the following steps:

- A. Lift the condenser filter off of the machine cover panel. Visually inspect the condenser filter for dirt (Fig. 4-4).



Figure 4-4 Removing Condenser Filter

- B. If the condenser filter is dirty, vacuum or brush it clean. Rinse it with clean water and allow it to dry before replacing it on the machine.

NOTE

If the condenser is not kept clean, refrigeration efficiency will be lost.

4.14 PREVENTATIVE MAINTENANCE

It is recommended that a preventative maintenance schedule be followed to keep the machine clean and operating properly. The following steps are suggested as a preventative maintenance guide.

The United States Department of Agriculture and the Food and Drug Administration require that lubricants used in food zones be certified for this use. Use lubricants only in accordance with the manufacturer's instructions.

- A. Daily checks
 - Check for any unusual noise or condition and repair immediately.
- B. Monthly checks
 1. Check drive belts for wear and tighten belts if necessary. (Refer to section 4.12)
 2. Check the condenser filter for dirt. (Refer to section 4.13).

4.15 EXTENDED STORAGE

Refer to the following steps for winterizing the machine or for storing the machine over any long period.

- A. Clean all of the parts that come in contact with mix thoroughly with warm detergent. Rinse in clear water and dry all parts. Do not sanitize.

NOTE

Do not let cleaning solution stand in machine barrel or mix pump during the shutdown period.

- B. Remove, disassemble, and clean the front door, auger shaft, and mix pump. Leave disassembled during the shutdown period.
- C. Place the plastic auger flights in a plastic bag with a moist paper towel. This will prevent the flights from becoming brittle if exposed to dry air over an extended period (over 30 days).
- D. For water-cooled machines that are left in unheated buildings, or buildings subject to freezing, the water must be shut off and disconnected. Disconnect the fittings at the water inlet and the water outlet lines of the machine. The fittings are located at the rear of the machine. Run the compressor for 2 - 3 minutes to open the water valve. Blow out all the water, first through the water inlet, then through the water outlet lines with air or carbon dioxide. Drain the water supply line coming to the machine.
- E. Place the Pump OFF/ON switch and the Main Freezer Power OFF/ON switch in the OFF position.
- F. Disconnect the machine from the source of the electrical supply in the building.

SECTION 5 REFRIGERATION SYSTEM

5.1 REFRIGERATION SYSTEM

The F431 refrigeration system has two functions:

Medium-Temperature - Maintaining product temperature in the cab unit and providing refrigeration to the mix transfer line.

Low-Temperature - Producing and maintaining high quality soft serve in the freezing cylinders.

The system is designed for efficient use with R404A refrigerant. The proper charge is indicated on the information plate.

NOTE

For qualified service personnel only. Anybody working with refrigerants must be certified as a Technician TYPE I as required by 40 CFR 82 Subpart F and hold all State and/or local refrigerant handling certifications. In addition, all handling, storage, and disposal of refrigerants must be in accordance with Environmental Protection Agency (EPA) guidelines and standards and all State and local guidelines and standards.

5.2 REFRIGERANT RECOVERY AND EVACUATION

Refer to the following procedures to properly recover and evacuate the refrigeration system. Do not purge refrigerant into the atmosphere.



WARNING

Hazardous voltage

The Main Freezer Power switch must be placed in the OFF position when disassembling for servicing. The machine must be disconnected from electrical supply before removing any access panel. Failure to disconnect power before servicing could result in death or serious injury.

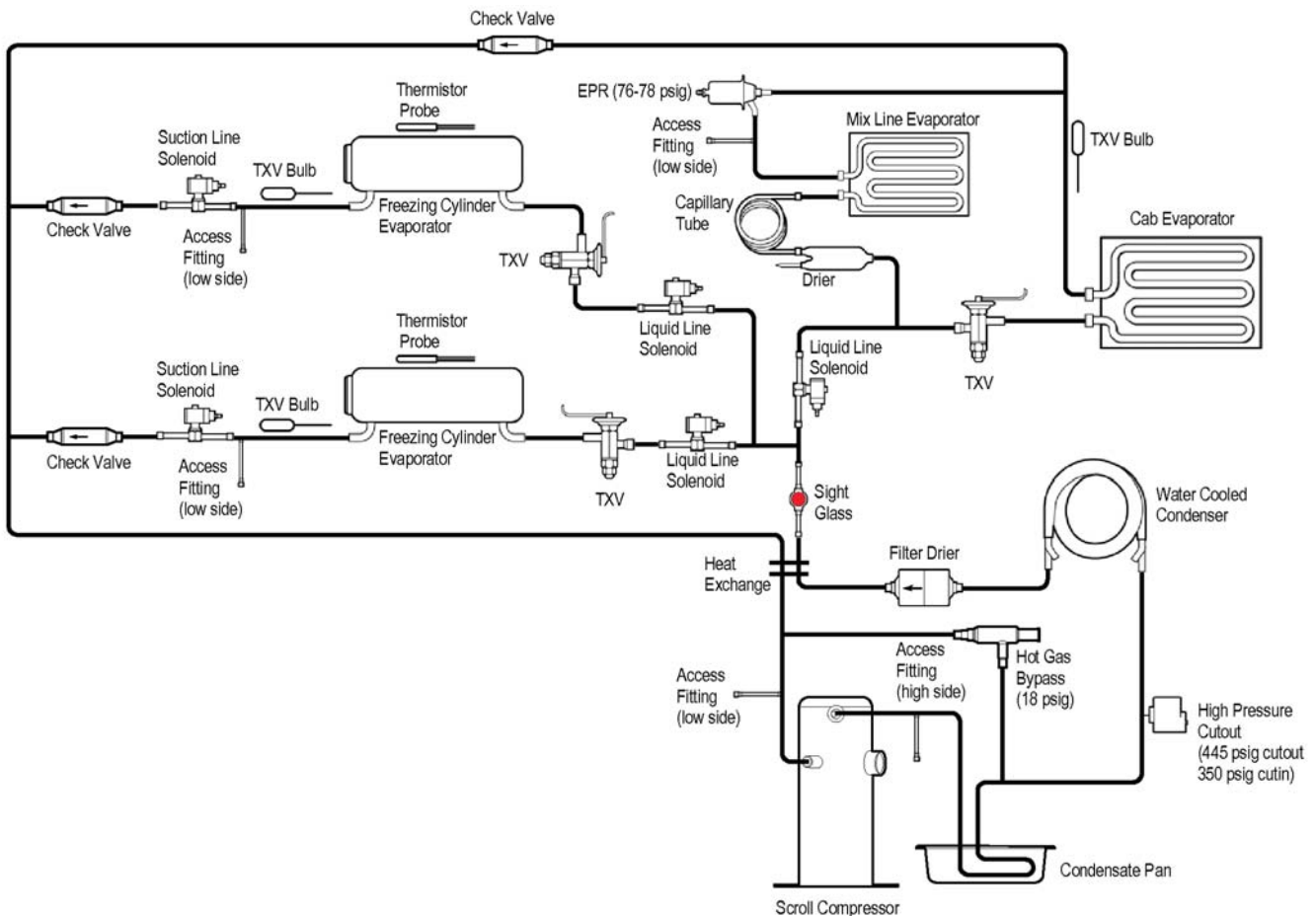

Figure 5-1 Water Cooled Refrigeration System

A. REFRIGERANT RECOVERY

1. Disconnect the machine from electrical supply before removing any panels for servicing.
2. Remove all panels.
3. Connect the recovery unit to the suction and discharge service valves of the compressor.
4. Locate the compressor contactor behind the header panel and disconnect the brown wire #90.
5. Wrap electrical tape around wire to insulate it.
6. Remove belts from the pulleys to allow drive motors to spin freely.
7. Connect power to the machine.
8. Turn the Main Power OFF/ON switch and Freezing Cylinder OFF/ON switches to the ON position.
9. Press the Push To Freeze button on both IntelliTec controls. This will energize the solenoid valves.

CAUTION
The solenoid valves must be energized to allow all refrigerant to be recovered and to prevent injury when brazing.

10. Operate the recovery unit per manufacturer's instructions

NOTE

If recovery is not completed after 30 minutes, press the Push To Freeze buttons again. This will keep the solenoid valves open.

B. EVACUATING THE REFRIGERATION SYSTEM

1. Close any open ports in the refrigeration system.
2. Connect a vacuum gauge to one of the Schrader valves next to an evaporator.
3. Connect the evacuation unit to the suction and discharge service valves of the compressor.
4. Locate the compressor contactor behind the header panel and disconnect the brown wire #90.
5. Wrap electrical tape around wire to insulate it.
6. Remove belts from the pulleys to allow drive motors to spin freely.
7. Connect power to the machine.
8. Turn the Main Power OFF/ON switch and Freezing Cylinder OFF/ON switches to the ON position.
9. Press the Push To Freeze button on both IntelliTec controls. This will energize the solenoid valves
10. Evacuate the system until the gauge reads 300 μ Hg for 5 continuous minutes.

NOTE

If evacuation is not completed after 20 minutes, press the Push To Freeze button again. This will keep the solenoid valves open.

11. If the system will not maintain a standing vacuum test with the vacuum pump off (gauge increases towards atmosphere), find the leak, fix it, and evacuate again.

5.3 REFRIGERANT CHARGING

Refer to the following procedures to properly charge the refrigeration system. Stoelting recommends liquid refrigerant charging.

NOTE

For qualified service personnel only. Anybody working with refrigerants must be certified as a Technician TYPE I as required by 40 CFR 82 Subpart F and hold all State and/or local refrigerant handling certifications. In addition, all handling, storage, and disposal of refrigerants must be in accordance with Environmental Protection Agency (EPA) guidelines and standards and all State and local guidelines and standards.

- A. Ensure the electrical supply has been removed before continuing.



WARNING

Hazardous voltage

The Main Freezer Power switch must be placed in the OFF position when disassembling for servicing. The machine must be disconnected from electrical supply before removing any access panel. Failure to disconnect power before servicing could result in death or serious injury.

- B. If the system has been opened or if there was a leak, refer to Section 5.2 - Refrigerant Recovery and Evacuation to evacuate the system prior to charging.
- C. Refer to machine's information plate for total charge requirements.

NOTE

The refrigeration system of the F431 is critically charged. Be sure to charge the system to the weight listed on the machine's information plate.

- D. For liquid refrigerant charging, connect refrigerant cylinder to the discharge Schrader valve of the compressor.
- E. Energize all five solenoid valves. There are three liquid line solenoids and two suction line solenoids.
- F. Add the proper amount of refrigerant according to the machine's information plate.

5.4 COMPRESSOR

The F431 has a scroll type compressor (Refer to Figure 5-2). This compressor type uses two spiral shaped scrolls to compress gas. One scroll rotates around an identical stationary scroll. Gas is drawn into the compression chamber by the rotating scroll and is compressed as it moves towards the center of the chamber. Operation of this compressor is continuous because, during each rotation, several gas 'pockets' are compressed simultaneously.

Details of the compressor's starting components are in Section 6.



Figure 5-2 Scroll Type Compressor

A. WINDING TEST

To test the compressor motor windings for possible problems, perform the following steps:

- A. Disconnect the machine from electrical supply before removing any panels for servicing.
- B. Remove the left side panel.
- C. Pull the compressor connector plug off of the compressor. The compressor has three terminals; C (common), R (run), and S (start). (Refer to Figure 5-3)

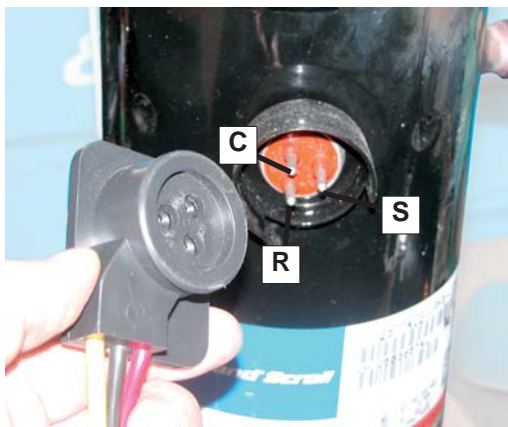

Figure 5-3 Compressor Connection

- D. Connect an ohmmeter to the C and R terminals. Resistance through the run winding should be $1.81\Omega \pm 10\%$.
- E. Connect ohmmeter to terminals C and S. Resistance through the start winding should be $2.27\Omega \pm 10\%$.
- F. To check if windings are shorted to ground, connect one ohmmeter lead to a bare metal part on the compressor (such as any copper line leading to or from the compressor) and check terminals C, R, and S.

NOTE

The compressor is equipped with an internal overload protector. If the compressor is warm and ohmmeter readings indicate an open winding, allow up to one hour for overload to reset.

B. COMPRESSOR REMOVAL

- A. Disconnect the machine from electrical supply before removing any panels for servicing.
- B. Disconnect the electrical plug from the compressor.
- C. Recover refrigerant charge per the instructions in Section 5.2.
- D. Leave the suction and discharge ports open to prevent pressure buildup during compressor removal.
- E. Remove six inches of insulating tubing on the suction line going to the compressor and unsweat the suction and discharge line from the compressor.
- F. Remove the four nuts and washers from the base of the compressor.
- G. Remove the compressor through the side of the machine.
- H. Remove the four rubber compressor mounts from the compressor.
- I. Crimp and braze all open ports of the old compressor.

NOTE

A compressor returned to Stoelting with any open ports will void the warranty. ALWAYS crimp and braze ports on a compressor that has been removed.

C. COMPRESSOR INSTALLATION

- A. Disconnect the machine from electrical supply before removing any panels for servicing.



WARNING

Hazardous voltage

The Main Freezer Power switch must be placed in the OFF position when disassembling for servicing. The machine must be disconnected from electrical supply before removing any access panel. Failure to disconnect power before servicing could result in death or serious injury.

- B. Install the four rubber mounts on the compressor.
- C. Install the compressor into the machine, fitting the base over the four bolt holes.
- D. Install the four washers and nuts onto the bolts and tighten securely.
- E. Remove all tubing plugs from the replacement compressor.

NOTE

The compressor plugs protect the compressor from moisture in the air. Do not remove the plugs until you are ready to install. The compressor must not be opened to the atmosphere for more than 10 minutes.

- F. Leave the suction and discharge ports open to prevent pressure buildup. Braze the suction and discharge line to the compressor.
- G. Connect the electrical plug to the compressor. The plug is keyed and will only install one way. (Refer to Figure 5-3)
- H. Replace the drier per the instructions in Section 5.9.
- I. Evacuate the system per the instructions in Section 5.2
- J. Recharge the system per the instructions in Section 5.3.
- K. Replace the insulating tubing on the suction line.

5.5 CONDENSER

The F431 is available with a water-cooled or an air-cooled condenser. The capacity of the machine is directly related to keeping the condenser clean and free of debris.

The water-cooled condenser is a tube and shell type. This condenser requires cool, clean water to function properly. Inlet and discharge lines must be 3/8" ID minimum.

The air-cooled condenser is a copper tube and aluminum fin type. The machine must have a minimum of 3" of clearance on the sides and 6" clearance at the back for proper air flow.

CONDENSER TESTING

The condenser can be checked for leaks using the bubble test or using a leak detector.

5.6 EVAPORATOR

The F431 has two freezing cylinder evaporators, one cab evaporator, and a mix line evaporator.

EVAPORATOR TESTING

The evaporator can be checked for leaks using the bubble test or using a leak detector.

NOTE

Foam insulation in the evaporator will set off electronic leak detectors if disturbed.

5.7 VALVES

A. THERMOSTATIC EXPANSION VALVE (TXV)

The Thermostatic Expansion Valve (TXV) is used to meter the refrigerant to the evaporator. It does so by maintaining a low, constant superheat in the evaporator. The self-regulating TXV is preset by the manufacturer and adjustment is not recommended. Figure 5-4.

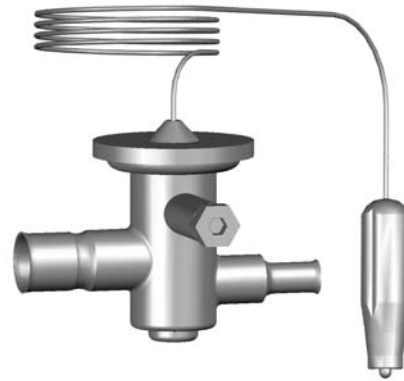

Figure 5-4 TXV

TXV TESTING & ADJUSTMENT

When testing a TXV, run only the evaporator that the TXV meters. If checking the left side TXV, place the right side freezing cylinder and cab switches to the OFF position. If checking the right side TXV, place the left side freezing cylinder and cab switches in the OFF position. If checking the cab TXV, place the both freezing cylinder switches in the OFF position.

NOTE

The bulb has an indent which must be positioned against the tubing. Good contact between the bulb and the suction line is necessary for proper operation of the valve. The bulb must also be well insulated.

- A. Connect a gauge to the Schrader valve on the suction line next to the evaporator.
- B. Connect a thermocouple to the suction line next to the evaporator.
- C. Immediately before the refrigeration cycle ends, the gauge should read between 20-22 psig.

- D. If the pressure reading is higher than expected and the superheat is low, check to see if there is an overcharge of refrigerant.
- E. If the pressure reading is lower than expected and the superheat is high, check to see if there is a low refrigerant charge or if there is a restriction in the system.

NOTE

The TXV is the LAST component to adjust in the refrigeration system.

- F. The TXV can be adjusted after the steps above are completed. When adjusting, do not turn the valve over 1/4 turn (90°). Turn the valve stem clockwise to increase the superheat or counterclockwise to decrease the superheat.

TXV REMOVAL

- A. Remove the side panel.
- B. Remove bulb from suction line exiting from the evaporator.
- C. Recover refrigerant charge per instructions in Section 5.2.
- D. Leave the suction and discharge ports open to prevent pressure buildup during TXV removal.
- E. Remove any insulation from the TXV and immediate surrounding lines.
- F. Apply a heat sink (wet cloth) to the valve dome.
- G. Unsweat the TXV and remove.

TXV REPLACEMENT

To replace the TXV, perform the following procedures:

- A. Position the TXV with a heat sink into the system.
- B. With the suction and discharge ports open, braze the TXV into the system using appropriate brazing material.
- C. Remove the heat sink from the TXV.
- D. Install bulb on suction line exiting the evaporator using existing clamp. The bulb has an indent which must be placed against the tubing.

NOTE

Good contact between the bulb and the suction line is necessary for proper operation of the valve. The bulb must also be well insulated.

- E. Tighten clamp to 20 in/lb using a torque wrench.
- F. Replace insulation to the TXV and surrounding lines.
- G. Replace the drier per the instructions in Section 5.9.
- H. Evacuate the system per the instructions in Section 5.2.
- I. Recharge the system per the instructions in Section 5.3.

B. CHECK VALVE

The F431 has 3 magnetic check valves (Refer to Figure 5-5). Each valve is positioned in the suction line and prevents backflow of refrigerant into the evaporator. If there is reversed flow, the product in the freezing cylinder softens and liquid refrigerant can flood into the compressor on startup.

If a check valve needs to be replaced, use a heat sink (wet cloth) when installing the new valve to prevent damage.



Figure 5-5 Check Valve

C. HIGH PRESSURE CUTOUT

The high pressure cutout stops the compressor if the discharge pressure reaches 445 psig.

HIGH PRESSURE CUTOUT TEST

- A. Connect a gauge to the Schrader valve on the discharge line.
- B. Disconnect cooling:
 - Air-Cooled - Disconnect evaporator fan
 - Water-Cooled - Shut off water supply
- C. High pressure cutout should trip when pressure reaches 445 psig ±9.

HIGH PRESSURE CUTOUT REMOVAL

- A. Remove the left side and top panels.
- B. Recover refrigerant charge per instructions in Section 5.2.
- C. Leave the suction and discharge ports open to prevent pressure buildup during removal.
- D. Unsweat capillary tube from suction line.
- E. Remove two screws from top of machine (Refer to Figure 5-6).

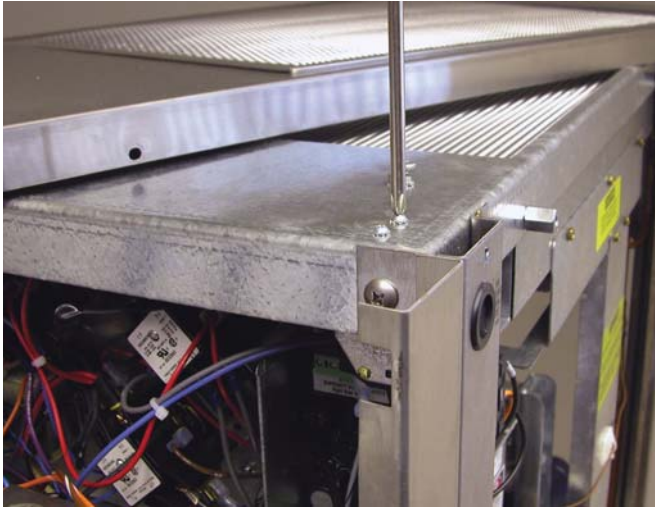

Figure 5-6 High Pressure Cutout Removal

- F. Disconnect terminals from high pressure cutout.

HIGH PRESSURE CUTOUT REPLACEMENT

- A. With the suction and discharge ports open, braze the capillary tube to the discharge line.
- C. Replace the drier per the instructions in Section 5.9.
- D. Braze bulb into place on suction line.
- E. Evacuate the system per the instructions in Section 5.2.
- F. Recharge the system per the instructions in Section 5.3.
- G. Connect the pink wire to the COM terminal and the brown/gray wires to the #2 terminal.
- H. Attach the high pressure cutout to the top of the inside of the header panel using the two screws with star washers.

D. HOT GAS BYPASS

The hot gas bypass valve is installed in parallel to the compressor and helps to regulate the compressor temperature (Refer to Figure 5-7). When the cab evaporator is the only part of the system requiring refrigerant, the bypass valve will allow discharge gas to bypass into the suction line to prevent liquid refrigerant from entering the compressor.



Figure 5-7 Hot Gas Bypass

HOT GAS BYPASS ADJUSTMENT

NOTE

Before adjusting the hot gas bypass, check the EPR valve and adjust if necessary.

- A. Turn the Main Power OFF/ON switch and both Freezing Cylinder OFF/ON switches in the OFF position.
- B. Connect a gauge to the Schrader valve on the suction line next to the compressor.
- C. Open the cab door and place a piece of tape on the cab door interlock switch.

NOTE

The cab door remains open for this test. The relatively warm ambient air will keep the cab refrigeration running.

- D. Turn the Main Power OFF/ON switch to the ON position.
- E. Wait 5 minutes to allow the gauge to stop moving.
- F. Unscrew the seal cap from the top of the valve.
- G. Using a 5/16" Allen wrench, adjust the valve counterclockwise to decrease pressure and clockwise to increase pressure. (Refer to Figure 5-8)



Figure 5-8 Hot Gas Bypass Adjustment

NOTE

Each 360° turn will change the pressure about 6 psig.

- H. Adjust the hot gas bypass valve to 18 psig \pm 1.
- I. Wait 2 minutes to ensure pressure remains stable.
- J. Hand-tighten seal cap to valve.

HOT GAS BYPASS REMOVAL

- A. Remove the side and rear panels.
- B. Recover refrigerant charge per instructions in Section 5.2.
- C. Remove insulation around hot gas bypass and tubing.
- D. Leave the suction and discharge ports open to prevent pressure buildup during hot gas bypass removal.
- E. Apply a heat sink (wet cloth) to the hot gas bypass.
- F. Unsweat the hot gas bypass and remove.

HOT GAS BYPASS REPLACEMENT

To replace the hot gas bypass, perform the following procedures:

- A. Apply a heat sink (wet cloth) to the hot gas bypass.
- B. With an open port, braze the hot gas bypass into the system using appropriate brazing material.
- C. Remove the heat sink from the hot gas bypass.
- D. Replace the filter drier. Refer to Section 5.8 for details.
- E. Evacuate and recharge system per instructions in Section 5.2.

E. EVAPORATOR PRESSURE REGULATOR (EPR)

There is one EPR in the F431 refrigeration system (Refer to Figure 5-9). It is located on the suction line of the refrigerated mix line and regulates evaporator refrigerant pressure.

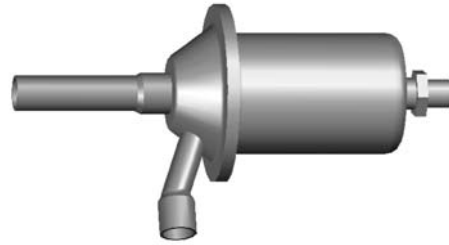

Figure 5-9 EPR Valve

EPR TEST AND ADJUSTMENT

- A. Place the Main Power OFF/ON switch and both Freezing Cylinder OFF/ON switches in the OFF position.
- B. Connect a gauge to the Schrader valve on the suction line between the mix line evaporator and the EPR.
- C. Place the Main Power OFF/ON switch to the ON position and place both Freezing Cylinder OFF/ON switches in the OFF position.
- D. Open the cab door and place a piece of tape on the cab door interlock switch.

NOTE

The cab door remains open for this test. The relatively warm ambient air will keep the cab refrigeration running.

- E. If the gauge does not read 78 \pm 2 then adjustment is needed.
- F. Remove the plastic cap and loosen the locknut on the EPR. Using a small screwdriver, turn the adjustment screw counterclockwise 1/2 turn, then adjust as necessary. Turn the valve stem clockwise for higher pressure or counterclockwise for lower pressure.
- G. Allow the system to stabilize for 5 minutes to ensure pressure remains stable.

EPR REMOVAL

- A. Remove the side panel.
- B. Recover refrigerant charge per instructions in Section 5.2.
- C. Leave the suction and discharge ports open to prevent pressure buildup during EPR removal.
- D. Unsweat the EPR and remove.

EPR REPLACEMENT

To replace the EPR, perform the following procedures:

- A. Apply a heat sink (wet cloth) to the EPR.
- B. With an open port, braze the EPR into the system using appropriate brazing material.
- C. Remove the heat sink from the hot gas bypass.
- D. Replace the filter drier. Refer to Section 5.8 for details.
- E. Evacuate and recharge system per instructions in Section 5.2.

F. WATER VALVE (WATER COOLED MODELS ONLY)

The water valve monitors refrigerant pressure and opens on an increase of pressure. The opening point pressure is the refrigerant pressure required to lift the valve disc off the valve seat. (Figure 5-10)

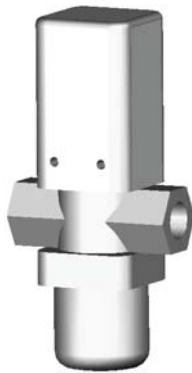

Figure 5-10 Water Valve

WATER VALVE ADJUSTMENT

- A. Remove the back panel.
- B. Connect a gauge to the compressor discharge Schrader valve.
- C. Connect the machine to the electrical supply, start the refrigeration cycle, and read the pressure.
- D. The proper gauge reading should be 225-235 psig. The exit water temperature should be 95-107°F.
- E. If the water temperature and high side pressure are too low, the opening point pressure should be increased to slow the water flow. Turn the adjustment screw counterclockwise.
- F. If the water temperature and high side pressure are too high, the opening point pressure should be decreased to increase the flow of water. Turn the adjustment screw clockwise.

WATER VALVE REMOVAL

The water valve is connected to the refrigeration system by capillary tube brazed to the discharge line.

- A. Turn off and disconnect the water supply. Blow out the water lines with compressed air or CO₂.
- B. Recover refrigerant charge per instructions in Section 5.2.

- C. Leave the suction and discharge ports open to prevent pressure buildup during water valve removal.
- D. Unsweat the capillary tube from the discharge line.
- E. Remove the clamps from the water lines at the valve.
- F. Remove the two screws holding the water valve to the frame and remove the valve.

WATER VALVE REPLACEMENT

To replace the water valve, perform the following procedures:

- A. Position the water valve and attach to the frame using the two screws.
- B. Install the water lines onto the valve with hose clamps.
- C. Leave the suction and discharge ports open to prevent pressure buildup during water valve installation.
- D. Braze the capillary tube into the system using appropriate brazing material.
- E. Connect the water supply line and turn on the water supply.
- F. Check for leaks in the water lines. If there are no leaks, turn off the water supply.
- G. Replace the filter drier. Refer to Section 5.8 for details.
- H. Evacuate and recharge system per instructions in Section 5.2.
- I. Turn on the water and check for leaks in the water lines with the refrigeration system running.
- J. Adjust the valve as necessary.

5.8 SOLENOID

Solenoid valves are installed on the liquid and suction lines of each freezing cylinder evaporator and on the liquid line of the cab evaporator (Refer to Figure 5-11). A solenoid valve has a magnetic coil that, when energized, lifts a plunger and allows refrigerant to flow. The solenoids are activated by the IntelliTec control and determine which evaporator receives refrigeration.

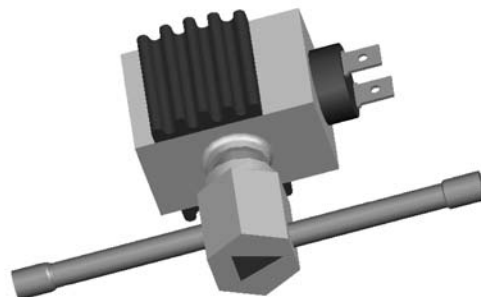

Figure 5-11 Solenoid Valve

The suction line solenoid prevents refrigerant flow in the evaporator when the suction pressure drops due to the operation of the other evaporators in the system.

ACTIVATING A SOLENOID

To open a solenoid, follow these steps:

- A. Turn the Main Power OFF/ON switch and both Freezing Cylinder OFF/ON switches to the OFF position.
- B. Locate the compressor contactor behind the header panel and disconnect the brown wire #90.
- C. Wrap electrical tape around wire to insulate it.
- D. Remove belts from the pulley to allow drive motor to spin freely.
- E. Connect power to the machine.
- F. Turn the Main Power OFF/ON switch and Freezing Cylinder OFF/ON switches to the ON position.
- G. Press the Push To Freeze button the IntelliTec control. This will energize the solenoid valve.

SUCTION LINE SOLENOID TESTING

To check for leaking valve seats, follow the procedure outlined below.

NOTE

Machine barrels must NOT contain frozen product for this test.

- A. Turn the Main Power OFF/ON switch and both Freezing Cylinder OFF/ON switches to the OFF position.
- B. To check the suction line solenoid valve seats, the liquid line solenoid must remain open.
- C. Attach a gauge to the Schrader valve after the TXV of the side being tested.
- D. Place the Main Power OFF/ON switch to the ON position.
- E. Place the opposite side Freezing Cylinder OFF/ON switch to the ON position.

NOTE

If checking the solenoid on the left side, place the right side Freezing Cylinder OFF/ON switch to the ON position. For the right side, place the left side switch to the ON position.

- F. Start a freezing cycle of the opposite side by pressing the Push To Freeze button or by pulling the spigot handle.
- G. If the pressure drops more than 3 psi in 30 seconds on the side being tested, the suction line solenoid valve seat leaks and should be replaced. Repeat the procedure for the other side.

LIQUID LINE SOLENOID TESTING

The following test will check if a liquid line solenoid has a leaking valve seat. The power to the solenoid is disconnected and refrigerant flow is monitored through the system. If the valve seat does not leak, the suction pressure during the test will read the same as the pressure when only the cab is running.

- A. Turn the Main Power OFF/ON switch and both Freezing Cylinder OFF/ON switches to the OFF position.
- B. Disconnect a terminal on each of the liquid line solenoids.
- C. Protect the terminal end of the disconnected electrical line with a piece of electrical tape.
- D. Attach gauges to the Schrader valves after the evaporators on the suction line.
- E. Turn the Main Power OFF/ON switch and both Freezing Cylinder OFF/ON switches to the ON position.
- F. Start a freezing cycle by pressing the Push To Freeze button or by pulling on the spigot handles.
- G. The gauges should show approximately 18 psig after 1 minute.
- H. Watch the pressure in both freezing cylinders. The freezing cylinder with the greatest pressure rise may have a leaking valve seat.

SOLENOID MAGNETIC COIL REMOVAL

- A. Remove the side panel.
- B. Disconnect the electrical wires.
- C. Remove the retainer screw from the top of the solenoid and pull the magnetic coil off.

SOLENOID MAGNETIC COIL INSTALLATION

To replace the magnetic coil, perform the following procedures:

- A. Connect the two electrical wires to the magnetic coil.
- B. Push the coil on to the solenoid valve stem.
- C. Make sure there isn't any foam insulation between the valve coil and valve body. Trim any excess insulation.
- D. Install retainer screw onto top of coil.

SOLENOID VALVE REMOVAL

- A. Recover refrigerant charge per instructions in Section 5.2.
- B. Remove insulation around valve and attached refrigeration lines.
- C. Apply heat sinks (wet cloth) to the insulated refrigerant lines near the valve.
- D. Leave a port open to prevent pressure buildup during solenoid removal.

- E. Identify and disconnect the two wires from the solenoid coil.
- F. Remove the retainer holding the coil to the solenoid body and remove the coil.
- G. Unsweat the solenoid and remove.

SOLENOID VALVE REPLACEMENT

To replace the solenoid, perform the following procedures:

- A. Position the new solenoid with the arrow pointing toward the direction of flow.
- B. Apply a heat sink (wet cloth) to the solenoid valve.
- C. With the suction and discharge ports open, braze the solenoid into the system using appropriate brazing material.
- D. Remove the heat sink from the valve.
- E. Replace insulation around valve.
- F. Replace the filter drier. Refer to Section 5.8 for details.
- G. Evacuate and recharge system per instructions in Section 5.2.

5.9 FILTER DRIER

The filter drier must be replaced every time the refrigeration system is opened for service. A new filter drier improves operation of the entire refrigeration system by stopping the circulation of moisture and by removing harmful contaminants (Refer to Figure 5-12).



Figure 5-12 Filter Drier

FILTER DRIER REMOVAL

- A. Recover refrigerant charge per instructions in Section 5.2.
- B. Cut the refrigeration line as close to the filter drier as possible and remove drier.
- C. Cap the ends of the drier using the plugs from the new drier.

NOTE

The drier must be capped to prevent moisture from the environment

FILTER DRIER REPLACEMENT

- A. Position the filter drier so the arrow is pointing towards the evaporators (pointing away from the condenser).
- B. Apply a heat sink (wet cloth) to the filter drier.
- C. With the suction and discharge ports open, braze the filter drier into the system using appropriate brazing material.
- D. Evacuate the system per instructions in Section 5.2.
- E. Recharge the system per instructions in Section 5.3.

5.10 CAPILLARY TUBE & DRIER ASSEMBLY

The capillary tube meters refrigerant flow in the mix line evaporator (Refer to Figure 5-13). The amount of flow is dependent on the length and ID of the capillary tube as well as the refrigerant charge.



Figure 5-13 Capillary Tube and Drier Assembly

CAPILLARY TUBE REMOVAL

NOTE

The capillary tube assembly contains a drier. The entire assembly must be removed.

- A. Recover refrigerant charge per instructions in Section 5.2.
- B. Leave a port open to prevent pressure buildup during capillary tube removal.
- C. Remove foam insulation from the capillary tube at the evaporator inlet.
- C. Unsweat the capillary tube and remove.

CAPILLARY TUBE REPLACEMENT

- A. Position the capillary tube so the arrow is pointing towards the evaporators (pointing away from the condenser).
- B. Apply a heat sink (wet cloth) to the capillary tube and drier assembly.

- C. With the suction and discharge ports open, braze the capillary tube into the system using appropriate brazing material.
- D.. Replace foam insulation to the capillary tube at the evaporator inlet.
- E. Evacuate the system per instructions in Section 5.2.
- F. Recharge the system per instructions in Section 5.3.

5.11 CAB UNIT

The IntelliTec control is programmed to handle refrigeration of the cabinet independently from the barrel. The control maintains cabinet temperature between two preset values (CabCutIn and CabCtOut). If the cabinet door is opened during a refrigeration cycle, the evaporator fan will continue to run but the refrigeration cycle will be interrupted to prevent the evaporator coils from icing up.

The refrigeration will run for a maximum of 4 minutes. After this time is reached, the refrigeration cycle will stop for a minimum of 3 minutes. At the expiration of 3 minutes, the control will check cabinet temperature. If product temperature is at or above CabCutIn, a refrigeration cycle will start.

To adjust temperature, refer to Section 4-4 Obtaining Readings and Modifying Settings.

SECTION 6 ELECTRICAL AND MECHANICAL CONTROL SYSTEMS

NOTE

The wiring diagram is available in Section 8.

6.1 INTELLITEC CONTROLLER

The IntelliTec control is Stoelting's most advanced controller. It combines all of the best features of previous controllers with advanced sensing and troubleshooting capabilities.

Understanding the modes of operation and individual control settings will make servicing the control straightforward.

A. COMPONENTS OF CONTROLLER

The IntelliTec control consists of three main components; the control board (Figure 6-1), the membrane switch (Figure 6-2), and the display panel module (Figure 6-3). The membrane switch is connected to the display panel module via a 9-pin ribbon cable. The display panel module is connected to the IntelliTec control board through a telephone cord. The IntelliTec control board is connected to the machine through an 8-pin connector, a 7-pin connector, and a 6-pin connector.

The left side membrane switch (touchpad) controls the left side of the machine and the right side membrane switch controls the right side. The IntelliTec control boards are mounted in the same respect; the left control board runs the left side and the right control board runs the right side.



Figure 6-1 IntelliTec Control Board

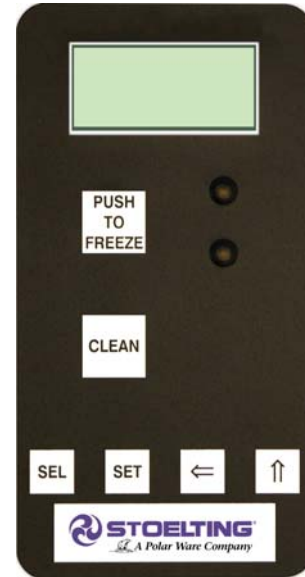

Figure 6-2 Membrane Switch

6.2 CONTACTORS

The compressor and drive motor contactors are mounted inside the electrical box behind the header panel. There is one contactor for the compressor and a contactor for each drive motor.

The IntelliTec control sends electronic signals to trigger the contactors. Separate signals are used to control each drive motor contactor and the compressor contactor. The signals to the contactors are staggered, so the drive motor will always start and stop three seconds before the compressor. By staggering the starting and stopping of the drive motor, maximum starting torque is available and voltage spikes are reduced.

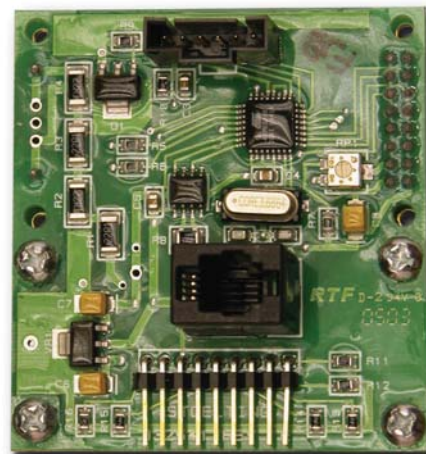

Figure 6-3 Display Panel Module

A. CONTACTOR TESTS

The following tests will show if a contactor is working properly.

1. Open header panel and visually check the IntelliTec control board.
2. Check for a signal going to contactor. When the spigot is opened or the Push To Freeze button is pressed, the DRV LED on the control board will light up. After three seconds, the CMP LED will light up (Refer to Figure 6-4). If the LEDs do not light up, refer to Section 7 Troubleshooting.

NOTE

In addition to the LEDs lighting, there will be an audible click from the contactors and the motor and compressor will start.

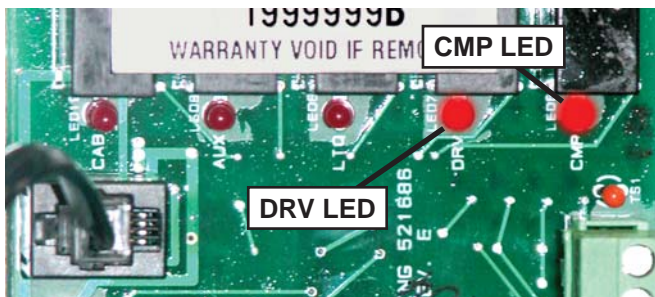

Figure 6-4 IntelliTec LEDs

3. Check to ensure contactor is receiving signal. Read voltage across the coils of the contactor during a freezing cycle. Voltage should be about 115V. If there is no voltage reading, refer to Section 7 Troubleshooting.

6.3 DRIVE MOTOR

The drive motors are designed specifically for the F431 machines. The drive motors are used to rotate the auger assemblies. An internal, normally closed, centrifugal switch starts the drive motor. The motors have an internal thermal overload.

A. DRIVE MOTOR REMOVAL

1. Disconnect machine from electrical supply before removing any panels for servicing.
2. Remove the back panel and the side panel (of the side being removed).
3. Remove the electrical cover plate from the back of the motor.
4. Identify (mark) wires and remove them from the motor.
5. Remove protective shield from side of machine. (Refer to Figure 6-5)

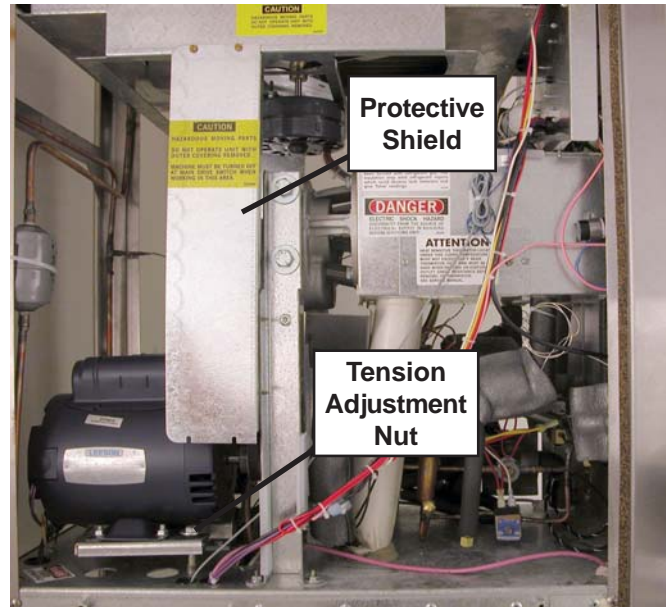

Figure 6-5 Motor Removal

6. Loosen the belt tension adjustment nut and remove the belt. (Refer to Figure 6-5)
7. Remove the motor mounting bolts.
8. Loosen the two allen head screws from the pulley.
9. Remove the pulley and key from the motor shaft.

B. DRIVE MOTOR INSTALLATION

1. Place the drive motor in position and install the four mounting bolts.
2. Place the pulley and key on the motor shaft.

NOTE

Do not tighten the pulley screws until after the belt tension has been properly adjusted.

3. Install the belt and tighten the tension bolt.
4. Test for proper belt tension by pressing firmly on the belt. When the tension is properly adjusted, the belt should depress approximately 3/8" (roughly the width of the belt).

5. Using a straightedge, align the drive motor pulley with the gearbox pulley. Tighten the two allen head screws.
6. Install wiring according to wiring diagram (located behind header panel). Install electrical cover plate.
7. Install protective shield.
8. Install back and side panels.

6.4 CAPACITORS

The compressor start and run contactors are mounted behind the side panels. The start and run capacitors for the drive motors are mounted directly onto each motor body.

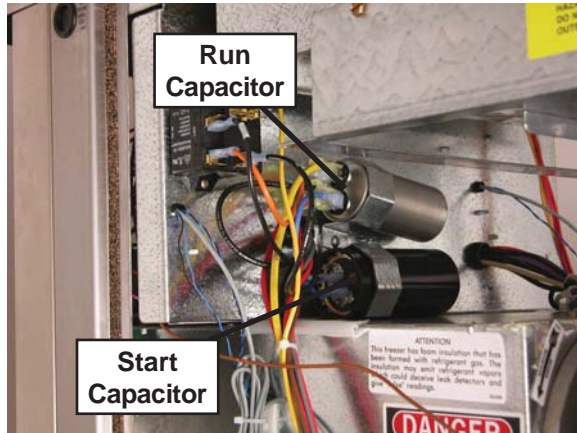

Figure 6-6 Compressor Capacitors

A. CAPACITOR TEST

1. Disconnect machine from electrical supply before removing any panels for servicing.



WARNING

Hazardous voltage

The Main Freezer Power switch must be placed in the OFF position when disassembling for servicing. The machine must be disconnected from electrical supply before removing any access panel. Failure to disconnect power before servicing could result in death or serious injury.

2. Place the Main Power OFF/ON switch and both Freezing Cylinder OFF/ON switches in the OFF position.
3. Remove a lead from one of the capacitor terminals.
4. Using insulated pliers, discharge the capacitor by connecting a 20KΩ 5W resistor across the terminals.

NOTE

Discharge the capacitor even if there is a bleeder resistor across the terminals. There may be an open in the bleeder resistor preventing it from working properly.

5. Disconnect the bleeder resistor from the circuit.
6. Check the capacitance across the terminals. Refer to the table below for the correct readings.

	Part	Rating	
		MFD	VAC
Drive Motor Start	231095	500 MFD	125 VAC
Drive Motor Run	231078	50 MFD	370 VAC
Compressor Start	231079	145-174 MFD	220 VAC
Compressor Start	230649	130-156 MFD	250 VAC
Compressor Run	231084	30 MFD	370 VAC
Compressor Run	230633	30 MFD	370 VAC

B. CAPACITOR REPLACEMENT

1. Disconnect machine from electrical supply before removing any panels for servicing.
2. Place the Main Power OFF/ON switch and both Freezing Cylinder OFF/ON switches in the OFF position.
3. Remove leads from the capacitor terminals.
4. Using insulated pliers, create a short across the capacitor terminals with a 20KΩ 5W resistor to discharge the capacitor.

NOTE

Create the short even if there is a bleeder resistor across the terminals. There may be an open in the bleeder resistor preventing it from working properly.

5. Pull the capacitor out of its holder and replace.
6. Connect the leads to the terminals.

6.5 GEARBOX

A. GEARBOX INSPECTION

Inspect the gearbox and listen for unusual noise. A grinding sound generally indicates a bad gear.

B. GEARBOX REMOVAL

1. Disconnect machine from electrical supply before removing any panels for servicing.
2. Remove the back panel and the side panel (of the side being removed).
3. Remove protective shield from side of machine.
4. Remove the belts.
5. Remove the pulley by loosening the set screws.
6. Remove the three bolts holding the gearbox to the barrel.
4. Remove the two bolts holding the gearbox to the mounting bracket and remove the gear box through the rear of the machine.

C. GEARBOX INSTALLATION

1. Place the gear box in position from the rear of the machine. Fasten the three bolts through the gear box to the rear of the barrel.
2. Fasten the gearbox to the mounting bracket using the two bolts.
3. Mount the pulley on the gear box shaft and align with the motor pulley, then tighten the allen head screws.
4. Install the belt.
5. Press firmly on the belt.
6. When the tension is properly adjusted, the belt will depress the approximate width of the belt with the pressure of a finger.
7. If an adjustment is necessary, loosen the four motor plate retaining nuts, adjust belt tension then retighten the four nuts.

6.6 CONDENSER FAN MOTOR (AIR-COOLED ONLY)

A. FAN MOTOR REPLACEMENT

1. Disconnect machine from electrical supply before removing any panels for servicing.



WARNING

Hazardous voltage

The Main Freezer Power switch must be placed in the OFF position when disassembling for servicing. The machine must be disconnected from electrical supply before removing any access panel. Failure to disconnect power before servicing could result in death or serious injury.

2. Remove a side panel and the header panel.
3. Trace and disconnect the black and white wires on the T1 and T2 terminals on the compressor contactor.
4. Loosen set screw on fan blade.
5. Remove the three bolts from the fan motor mounting plate and remove the motor.

B. FAN MOTOR INSTALLATION

1. Attach motor to the mounting plate with the three bolts.
2. Place fan blade on motor shaft and tighten set screw.
3. Ensure purple wire is terminated.
4. Ensure red wire is terminated with blue wire.
5. Route white and black wires through the front panel to the compressor contactor.
6. Connect black wire to the T1 terminal.
7. Connect white wire to the T2 terminal.

6.7 CAB CONDENSER FAN MOTOR

A. FAN MOTOR REPLACEMENT

1. Shut the machine down and remove mix from the freezing barrel and cab.
2. Disconnect machine from electrical supply.
3. Remove the mix containers and sliding drawer from the cab.
4. Disconnect the evaporator drain tube and remove the two thumb screws on the evaporator cover. Pull the cover off and set aside.
5. Remove the tubes from the mix transfer line and air line.
6. Remove the four screws on the fan shroud. The screws are attached to the cab wall.
7. Pull thermistor out of the clip and thread it up through the hole in the fan shroud.
8. Remove the fan shroud by tilting forward and pulling down (Refer to Figure 6-7).

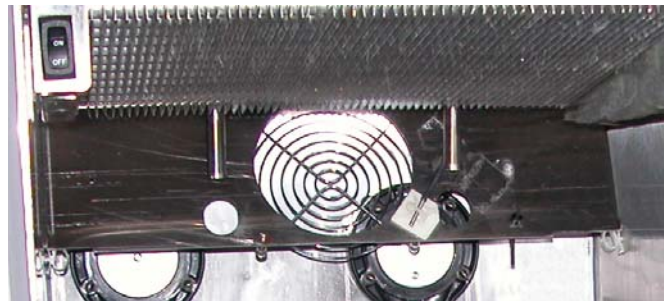

Figure 6-7 Cab Fan Shroud

9. Remove the two fan bracket screws and disconnect wires.
10. Connect the wires to the new fan motor.
11. Attach the two screws to the fan motor bracket.
12. Tilt the fan shroud and move it into place.
13. Thread thermistor through hole in fan shroud and attach it to the clip.
14. Install fan shroud into cab with the four screws.
15. Install evaporator cover with the two thumb screws.
16. Install all tubes and replace sliding drawer and mix containers.

6.8 SWITCHES

A. SPIGOT SWITCH

The spigot switch is a normally closed, held open switch. When a spigot is pulled, the spigot switch sends a signal to the IntelliTec control to start the auger drive and refrigeration system. This signal moves the control to “Serve Mode”, or if it already is in “Serve Mode”, it resets the cycle count. After serving product, the IntelliTec continues a freezing cycle until the product reaches consistency.

SPIGOT SWITCH TEST - ADJUSTMENT

NOTE

Adjustments to the spigot switch should be done after the product is at consistency in "Serve Mode" or when the machine is empty.

1. Open the spigot slowly and listen for a click when the spigot switch closes.
2. The clicking sound should be within the first 1/2" of the spigot glide movement (Refer to Figure 6-8). If the switch does not close, an adjustment may be necessary.

NOTE

The center spigot has two switches; one for each side. When testing the center spigot, there should be two audible clicks occurring almost simultaneously.

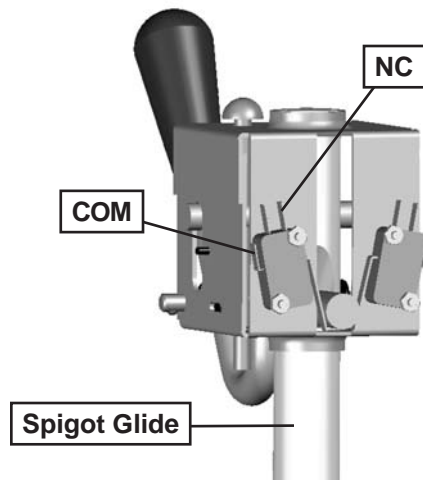

Figure 6-8 Spigot Cam Assembly (Center Spigot)

SPIGOT SWITCH TESTING - ELECTRICAL

1. Disconnect the switch from the circuit by unplugging the connectors.



WARNING

Hazardous voltage

The Main Freezer Power switch must be placed in the OFF position when disassembling for servicing. The machine must be disconnected from electrical supply before removing any access panel. Failure to disconnect power before servicing could result in death or serious injury.

2. Check resistance readings across the common (COM) and normally closed (NC) terminals. When the spigot is closed, the resistance should show an open. When the spigot is opened, the switch will close and the resistance should be 0 ohms. 49

SPIGOT SWITCH ADJUSTMENT

1. Place the Main Power OFF/ON switch and both Freezing Cylinder OFF/ON switches in the OFF position.
2. Remove the header panel.
3. Loosen the bolts on the spigot switch.
4. Using a pencil, mark the spigot glide 1/4" from the spigot housing.
5. Adjust the switch to activate when the plastic glide reaches the mark.
6. Fully tighten the retaining bolts and remove mark from spigot glide.

SPIGOT SWITCH REPLACEMENT

1. Remove the header panel.
2. Remove the dispense rate adjuster knob located below the header panel. (Refer to Figure 6-9)

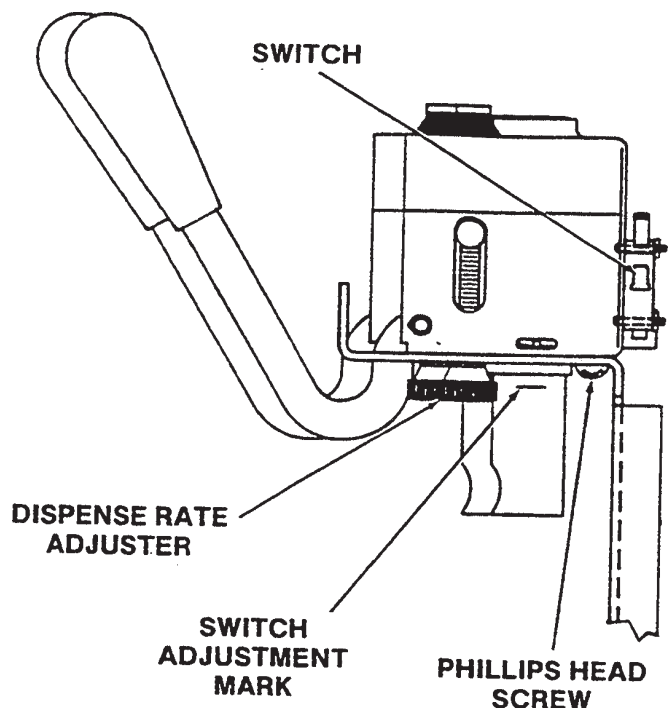

Figure 6-9 Spigot Switch Replacement

3. Remove the two Phillips head screws that attach the spigot cam assembly to the panel. Remove the assembly.
4. Disconnect the connector from the switch and remove the switch..
5. Install the replacement switch onto the handle assembly. Do not fully tighten the retaining screws at this time.
6. Using a pencil, mark the spigot glide 1/4" from the spigot housing. Adjust the switch to activate when the spigot handle moves the glide to the mark.

7. Fully tighten the retaining screws.
8. Attach the connector to the spigot switch.
9. Position the spigot handle assembly in the electrical box and fasten securely with the two Phillips head screws.
10. Replace the dispense rate adjuster knob and tighten.
11. Replace the header panel and secure with the two Phillips head screws.

B. PUMP PRESSURE SWITCH

The pump pressure switch maintains 21-24 psig in the mix line.

PUMP PRESSURE SWITCH TEST

1. Turn off the pump motor.
2. Open the spigot to relieve air pressure in the system.
3. Connect a gauge between the 1/4" ID tubing and pump outlet in the cab (Refer to Figure 6-10).

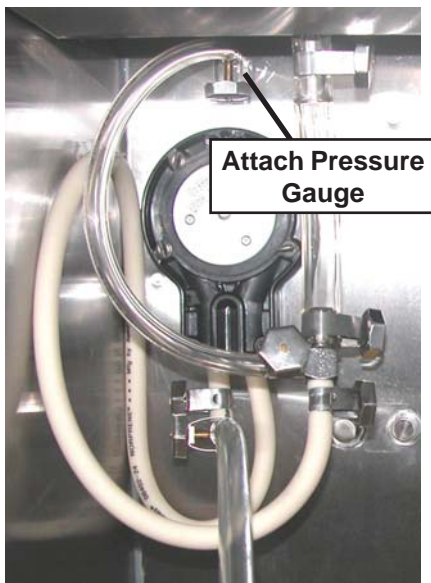

Figure 6-10 Attaching Gauge to Pump

4. Turn on the pump motor.
5. The motor should cutout when the gauge reads 24 psig \pm 1.
6. Open the spigot and monitor the gauge. The motor should cutin when the gauge reads 21 psig \pm 1.

6.9 TEMPERATURE CONTROL SENSOR

The temperature control sensor is a thermistor used to sense the temperature of the suction line. As the suction line temperature increases, the internal resistance of the thermistor will decrease. Refer to Figure 6-11 for the relationship between sensor resistance and temperature. The IntelliTec control board monitors this value. In "Serve Mode", when the temperature of the sensor equals the Cut In T value on the control, a freezing cycle will start.

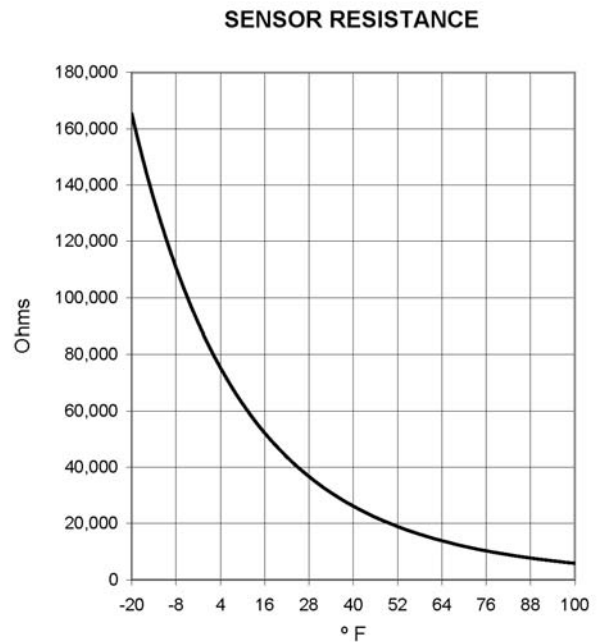

Figure 6-11 Resistance Related to Temperature

SECTION 7 TROUBLESHOOTING

7.1 ERROR CODES

When the machine experiences a problem, one of the following error codes will be displayed on the control panel. Each error code directs you to the system location of the malfunction.

ERROR CODE MALFUNCTION

1	Program Board
2	High Torque
3	Low Torque
4	Clean
5	Freezing Cylinder Sensor
6	Hopper Sensor (single hopper machines)
7	Drive Motor
8	Cab Sensor
9	High Pressure Cutout
10	Auxiliary Sensor
11	Low Temperature
12	Left Hopper Sensor
13	Right Hopper Sensor

To return the machine to normal operation, any error causing condition must be corrected and the Freezing Cylinder Off-On switch must be placed in the Off position and back in the On position before the affected side of the machine will return to normal operation.

7.2 TROUBLESHOOTING

ERROR CODE 1 - PROGRAM BOARD

If the control panel displays a Program Board Error (E1), place the Freezing Cylinder Off-On switch in the Off position and back in the On position. If the control panel still displays the error code, there may be a problem with a microprocessor on the IntelliTec control board. Replace the board.

ERROR CODE 2 - HIGH TORQUE

If the control panel displays a High Torque Error (E2), the controller has sensed that the drive motor is running at 125% of the preset CutOut amp setting for 10 or more seconds. Very low and/or fluctuating supply voltages typically cause this error. The error can also be caused by faulty motor or starting components which could produce a high amp draw.

ERROR CODE 3 - LOW TORQUE

The Low Torque Error (E3) occurs when the compressor runs continuously for 20 minutes without the product reaching consistency in "Serve Mode" or if the product does not reach

the SI2CtOut temperature in "Sleep 2 Mode". This error is generally caused by very low mix levels in the machine's mix container or from product breakdown. Another common cause results from a restriction preventing mix from entering the freezing cylinder. Check the mix on the affected freezing cylinder. If the level mix is low, add mix. If there is a possibility that the mix is broken down, clean and sanitize the machine and replace the mix with fresh product.

Ice crystals in the liquid mix container can clog the mix inlet system and prevent mix from entering the freezing cylinder. Thoroughly thaw mix per manufacturer's recommendations. To check for ice crystals, pour a small amount of product in the mix container through a clean and sanitized sieve or strainer. If ice crystals are in the mix, check the temperature of the walk-in cooler where the mix is stored or the temperature of the machine's cabinet. If the machine's cabinet is below 34°F (1°C), adjust the temperature from the left control touchpad, under the Storage Menu (Refer to Section 3 - Controller Adjustments).

In a cabinet machine or with a machine using a U3 mix pump, check the condition of the neoprene hose running through the mix pump head. If it shows signs of wear, rotate or replace it as outlined in the machine's or pump's Owner's Manual.

The Low Torque Error may also occur if airflow within the machine has reduced or stopped. Check the sides and top of the machine for anything that would restrict airflow. Check the condenser filter and clean if necessary. Check the evaporator for frost that could restrict airflow.

The compressor will run continuously if a solenoid valve fails to open. This could be due to loose wiring, magnetic coil failure, a stuck valve or a faulty control board.

After the cause of the problem is found and remedied place the Freezing Cylinder Off-On switch in the Off position and back in the On position.

ERROR CODE 4 - CLEAN

If the machine is left in the Clean Mode for more than 20 minutes, the control panel will display a Clean Error (Error 04). This condition does not reflect a problem with the machine itself. The Clean Error has been programmed into the controller as a safeguard to protect the machine from potential damage caused by the machine being accidentally left in "Clean Mode". To clear the Clean Error, place the Freezing Cylinder Off-On switch in the Off position and back in the On position.

ERROR CODE 5 - FREEZING CYLINDER SENSOR

The Freezing Cylinder Sensor Error (E5) indicates a failure of the barrel sensor or an extreme out of range condition ($< -34^{\circ}\text{F}$ or $> 99^{\circ}\text{F}$). If the control panel displays an E5, place the Freezing Cylinder Off-On switch in the Off position and back in the On position. If the control panel still displays the error code, refer to the machine's wiring diagram and the Temperature Sensor Chart (Figure 11). Check each lead of the sensor to ground for continuity. If continuity is found, replace the sensor. To check the resistance of the sensor, place a thermocouple on the suction line at the exit of the freezing cylinder. Compare temperature and sensor resistance with the table as reference. If measured value does not coincide with a value on the table (± 400 ohms), replace the sensor.

NOTE

When the machine encounters a Freezing Cylinder Sensor Error, the machine will continue to run using preset timers. This mode will allow the operator to continue serving product until the machine can be serviced.

ERROR CODE 6 - HOPPER SENSOR (SINGLE HOPPER MACHINES)

The Hopper Sensor Error (E6) indicates a failure of the hopper sensor or an extreme out of range condition ($< -34^{\circ}\text{F}$ or $> 99^{\circ}\text{F}$). If the control panel displays an E6, place the Freezing Cylinder Off-On switch in the Off position and back in the On position. If the control panel still displays the error condition code, refer to the machine's wiring diagram and the Temperature Sensor Chart (Figure 11). Check each lead of the sensor to ground for continuity. If continuity is found, replace the sensor. To check the resistance of the sensor, place a thermocouple on the suction line at the exit of the freezing cylinder. Compare temperature and sensor resistance with the table

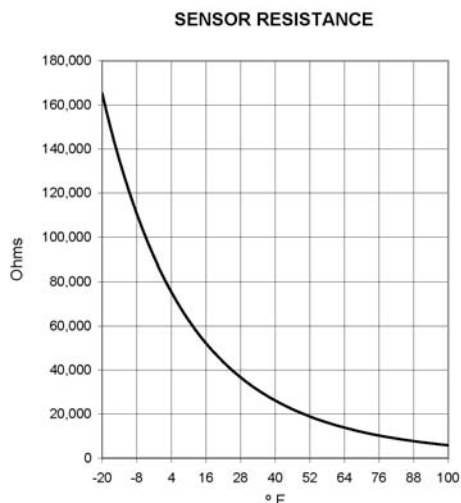

Figure 7-1 Temperature Sensor Resistance (10K Ohms)

as reference. If measured value does not coincide with a value on the table (± 400 ohms), replace the sensor.

ERROR CODE 7 - DRIVE MOTOR

If the control panel displays a Drive Motor Error (E7), the control does not sense current coming from the drive motor. Place the Freezing Cylinder Off-On switch in the Off position and back in the On position. If the error returns, use the machine's wiring diagram and check connections at the IntelliTec control and at the motor. An E7 may also be the result of a faulty drive motor contactor.

ERROR CODE 8 - CAB SENSOR

A Cab Sensor Error (E8) indicates a cabinet temperature sensor failure. This error will also appear in an extreme out of range condition ($< -34^{\circ}\text{F}$ or $> 99^{\circ}\text{F}$). To remedy this error, place the Freezing Cylinder Off-On switch in the Off position and back in the On position. If the control panel still displays the error condition code, refer to the wiring diagram and the temperature sensor value table. Check each lead of the sensor to ground for continuity. If continuity is found, replace the sensor. Place a thermocouple in the cabinet evaporator discharge airstream (outlet air flow). Compare temperature to sensor resistance using the table as reference. If Cutin/Cutout values do not coincide with the values on the table, replace the sensor.

ERROR CODE 9 - HIGH PRESSURE CUTOUT

High Pressure Cutout Errors (E9) are usually caused by a dirty or inefficient condenser. If the control panel displays an E9, place the Freezing Cylinder Off-On switch in the Off position. Press the High Pressure Cutout Reset switch and place the Freezing Cylinder Off-On switch back in the On position.

In air cooled condenser models, check the air filter to make sure it is clean. Replace or clean the filter as required. Check for proper air clearance around the machine. Refer to the machine's Owner's Manual for clearances. Check the condenser for blockage, and be sure condenser fan is functioning.

On water cooled condenser models, check for proper water flow through the condenser coil.

After the cause of the error is determined and corrected, place the Freezing Cylinder Off-On switch in the Off position and back in the On position.

ERROR CODE 10 - AUXILIARY SENSOR

An Auxiliary Temperature Sensor Error (R10) occurs if the temperature sensor on the control board fails. The control shuts down the system to prevent equipment damage. If there is an E10 the control board may be faulty.

ERROR CODE 11 - LOW TEMPERATURE

The Low Temperature Error (E11) occurs when the temperature of the gas refrigerant at the barrel sensor falls below -20°F or -34°F (depending on model). Although the machine will not shut down, the active freezing cycle will immediately end. This error usually occurs when the machine continues to run in a low mix condition or if the machine runs out of mix. The product towards the front of the barrel tends to freeze solid. When the temperature on the freezing cylinder lowers to the preset value, the IntelliTec control will display an E11.

ERROR CODE 12 - LEFT HOPPER SENSOR

The Left Hopper Sensor Error (E12) indicates a failure of the hopper sensor or an extreme out of range condition (< -34°F or > 99°F). If the control panel displays an E12, place the Freezing Cylinder Off-On switch in the Off position and back in the On position. If the control panel still displays the error condition code, refer to the machine's wiring diagram and the Temperature Sensor Chart (Figure 11). Check each lead of the sensor to ground for continuity. If continuity is found, replace the sensor. To check the resistance of the sensor, place a thermocouple on the suction line at the exit of the freezing cylinder. Compare temperature and sensor resistance with the table as reference. If measured value does not coincide with a value on the table (\pm 400 ohms), replace the sensor.

ERROR CODE 13 - RIGHT HOPPER SENSOR

The Right Hopper Sensor Error (E13) indicates a failure of the hopper sensor or an extreme out of range condition (< -34°F or > 99°F). If the control panel displays an E13, place the Freezing Cylinder Off-On switch in the Off position and back in the On position. If the control panel still displays the error condition code, refer to the machine's wiring diagram and the Temperature Sensor Chart (Figure 11). Check each lead of the sensor to ground for continuity. If continuity is found, replace the sensor. To check the resistance of the sensor, place a thermocouple on the suction line at the exit of the freezing cylinder. Compare temperature and sensor resistance with the table as reference. If measured value does not coincide with a value on the table (\pm 400 ohms), replace the sensor.

COMMO TIMEOUT ERROR

A COMMO TIMEOUT Error indicates a communication interruption between the display and the control board. This error can be caused by a poor connection or a faulty phone cable. Disconnect and reconnect the telephone cable at the control board. If the error does not clear, disconnect and reconnect the telephone cable at the display panel module. If the error still appears, the cable may be faulty or the display panel module may be faulty.

ALTERNATING FLASHING CONTROL PANEL LIGHTS

On machines with a Main Power Switch, when this switch is placed in the ON position and the Freezing Cylinder OFF/ON switch is in the OFF position, the green and amber display panel lights will flash in alternating sequence. This indicates that the storage cabinet or hopper is being refrigerated, but the left freezing cylinder is not receiving power. Placing the Freezing Cylinder OFF/ON switch in the ON position will return the freezing cylinder to the SLEEP mode. Pressing the PUSH TO FREEZE button will begin the freezing cycle.

The display panel lights will also flash in an alternating sequence under any error codes. Clear the error and place the Freezing Cylinder Off-On switch in the Off position and back in the On position.

7.3 SERVICING TIP

PREVENT COMPRESSOR FROM RUNNING DURING SERVICING

When servicing the machine, set the Refriger setting on the left IntelliTec control from 1 Hopper, 2 Hopper or Cabinet to None (Refer to Section 3.3). This will prevent the compressor from running. When service work has been completed, change the Refriger setting back to its previous value.

7.4 TROUBLESHOOTING - MACHINE

PROBLEM	POSSIBLE CAUSE	REMEDY
Drive motor (auger) “kicks-out”, or does not run.	<ol style="list-style-type: none"> 1. Power to machine is off. 2. Low line voltage. 3. Product too hard. 4. Front door not installed securely. 	<ol style="list-style-type: none"> 1. Check power to machine. 2. Check, must be $\pm 10\%$ of nameplate voltage. 3. Raise overrun. (See Section 4.8) 4. Install front door securely.
Compressor does not operate.	<ol style="list-style-type: none"> 1. Power to machine if off. 2. Low line voltage. 3. Compressor internal overload is cut-out. 4. Front door not installed securely. 	<ol style="list-style-type: none"> 1. Check power to machine. 2. Check, must be $\pm 10\%$ of nameplate voltage. 3. Check condenser (air cooled)(See Sect. 4.13), or water supply (water cooled). 4. Install front door securely.
Product too soft.	<ol style="list-style-type: none"> 1. CutOut setting is too low 2. Product break down. 	<ol style="list-style-type: none"> 1. Adjust CutOut setting to match product requirements.(See Section 3.10) 2. Fill with fresh product.
Freeze-up. (Product will not dispense easily.)	<ol style="list-style-type: none"> 1. CutOut setting is too high. 2. Low overrun setting. 3. Low pump pressure. 4. Large air pocket in barrel. 5. Auger turning counter-clockwise. 	<ol style="list-style-type: none"> 1. Adjust CutOut setting to match product requirements.(See Section 3.10) 2. Raise overrun. (See Section 4.8) 3. Check pump pressure. 4. Purge air from barrel. 5. Change rotation to clockwise.
Rear auger seal leaks.	<ol style="list-style-type: none"> 1. Seal missing or installed wrong. 2. Rear seal o-ring missing, broken or not lubricated. 3. Worn or scratched shaft. 	<ol style="list-style-type: none"> 1. Install correctly. (See Section 3.8) 2. Inspect for breakage and lubricate properly (See Section 3.8) 3. Replace shaft.
Spigot leaks.	<ol style="list-style-type: none"> 1. Spigot parts are not lubricated. 2. Chipped or worn o-rings. 3. O-rings on spigot installed wrong. 4. Nicks or scratched on front door where spigot is located. 	<ol style="list-style-type: none"> 1. Lubricate. (See Section 3.13) 2. Replace o-rings. 3. Remove spigot and check o-rings. 4. Replace front door.
Drive belts slipping or squealing.	<ol style="list-style-type: none"> 1. Drive belt tension not correct. 2. Worn belt(s). 3. Low overrun. 	<ol style="list-style-type: none"> 1. Adjust belt tension. (See Section 4.12) 2. Replace belts. 3. Check for air leak.
Mix temperature too warm in cab.	<ol style="list-style-type: none"> 1. Temperature control set too warm. 2. Cab door is open. 	<ol style="list-style-type: none"> 1. Decrease CabCtOut and CabCutIn (See Section 4.7) 2. Close the cab door.
Mix temperature too cold in cab.	<ol style="list-style-type: none"> 1. Temperature control set too cold. 	<ol style="list-style-type: none"> 1. Increase CabCtOut and CabCutIn (See Section 4.7)

7.5 TROUBLESHOOTING - MIX PUMP

PROBLEM	POSSIBLE CAUSE	REMEDY
<p>Pump motor does not run.</p>	<ol style="list-style-type: none"> 1. Power to pump is off. 2. Low voltage. 3. Mix pump hose jammed inside black cover/clamp. 4. Pump motor overloaded. 5. Pressure switch on pump is defective. 6. Defective motor/capacitor. 7. Defective toggle switch. 	<ol style="list-style-type: none"> 1. Supply power to pump. 2. Check for low voltage. 3. Disconnect pump from power source. Remove four cover/clamp thumb screws. Separate cover/clamp halves and remove outer half. Remove jammed hose. Clean and re-install cover/clamp and tighten four thumb screws securely. Allow motor thermal overload to reset. 4. Allow internal thermal overload to reset; determine overload cause and repair. 5. Check mechanical operation and continuity of pressure switch. 6. Check motor amperage draw and/or capacitor. Replace motor or capacitor. 7. Check continuity; repair or replace.
<p>Pump operates but cylinder will not fill.</p>	<p>Note 1: A properly working pump will fill an 8 oz. cup with mix in about 9 seconds.</p> <p>Note 2: Immediately after a bag change the pump may be unable to reestablish it's prime with the system at operating pressure. In this case, turn the pump off. Draw 2-3 pints to reduce system pressure to zero. Turn pump on. Purge remaining air in mix bag and pick-up hose.</p> <p>Important: before connecting the pick-up hose to the mix bag, remove as much air from the mix bag as possible.</p> <ol style="list-style-type: none"> 1. Out of Mix. 2. Mix pump hose kinked inside black cover/clamp. 3. Hoses assembled incorrectly. 4. Mix pump hose service life is exceeded. 5. Mix pump hose not connected to machine. 6. Ice crystals in mix. 7. Mix bag drawn against adapter. 8. Foreign objects in mix. 9. Check valve is backwards. 	<ol style="list-style-type: none"> 1. Replenish mix supply. 2. Disconnect pump from power source. Remove four cover/clamp thumb screws. Separate cover/clamp halves and remove outer half. Remove jammed hose. Clean and re-install cover/clamp and tighten four thumb screws securely. Allow motor thermal overload to reset. 3. Refer to diagram for correct hose connections. 4. Reposition/replace mix pump hose. See Section 4.9 5. Connect mix pump hose to machine. 6. Completely thaw mix prior to use. 7. Ensure bag is clear of pick-up tube. 8. Clear blockage. Use fresh mix. 9. Observe flow arrow for proper orientation.
<p>Overrun too low or no overrun.</p>	<ol style="list-style-type: none"> 1. Overrun setting too low. 2. Air leak. 3. Air compressor not pumping air. 4. Air check valve in backwards. 	<ol style="list-style-type: none"> 1. Increase overrun setting. 2. Tighten all hose clamps. 3. Contact local Stoelting Distributor. 4. Check arrow for direction of flow.

PROBLEM	POSSIBLE CAUSE	REMEDY
Overrun too high.	<ol style="list-style-type: none"> 1. Mix pump hose service life is exceeded. 2. Out of mix. 3. Overrun setting too high. 4. Pick-up leg of mix pump hose is collapsing. 	<ol style="list-style-type: none"> 1. Reposition/replace mix pump hose. 2. Replenish mix supply. 3. Decrease overrun setting. 4. Reposition hose.
Replacement mix pump hose won't feed through pump.	<ol style="list-style-type: none"> 1. Feeding hose into discharge hole of mix pump cover. 2. Hose ends not cut squarely. 3. Force feeding too quickly. 4. Pump motor not running. 	<ol style="list-style-type: none"> 1. Feed hose into suction side of cover. 2. Carefully cut hose end off squarely (no tails). 3. Gently and slowly assist feeding of hose up into pick-up hose side of cover. 4. Turn on motor switch.
Air exiting mix pick-up hose.	<ol style="list-style-type: none"> 1. Pickup tube check valve missing. 	<ol style="list-style-type: none"> 1. Contact local Stoelting Distributor.
Dispensed product air "pops"	<ol style="list-style-type: none"> 1. Overrun setting too high. 2. Mix pump hose service life is exceeded. 3. Overdrawing the machine's capacity. 4. Recent low mix condition. 	<ol style="list-style-type: none"> 1. Decrease overrun setting. 2. Reposition/replace mix pump hose. 3. Reduce dispense rate. 4. Open spigot fully and allow excess air to escape.
Mix leakage from pump.	CAUTION: To prevent mix pump damage from dried mix deposits, immediately disassemble and clean pump.	
	<ol style="list-style-type: none"> 1. Mix pump hose service life is exceeded. 	<ol style="list-style-type: none"> 1. Remove mix pump hose. Disconnect pump from power source. Remove mix pump cover/clamp. Clean the rollers a small amount of soapy water. Clean mix from pump. See Section 4.2 for hose replacement.
Pump is noisy/squeaking.	<p>Note: The action of the air compressor rocking arm creates a repetitive clicking sound during operation. This is normal.</p> <p>Note: The peristaltic mix pump has three squeeze rollers that use self lubricating bearings. If squeaking exists with the mix pump hose in place and stops with the hose removed, the squeeze roller bearings can be lubricated using a silicone based spray. Remove the mix pump hose. Disconnect pump from electrical power. Remove four cover/clamp thumbscrews. Remove entire cover/clamp as one unit. Spray silicone based lubricant on each end of each squeeze roller. Spin rollers to work lubricant into bearings. Repeat as needed.</p> <p>Caution: Do not use cleaning/dissolving type lubricants like wd-40. These lubricants are not bearing friendly and will accelerate bearing wear.</p>	
Mix in air hoses.	<ol style="list-style-type: none"> 1. Air/mix tee above black cover/clamp. 2. Air leak. 3. Mix hose on wrong air/mix tee fitting. 4. Pressure control manifold o-ring leak. 	<ol style="list-style-type: none"> 1. Air/mix tee must be below black cover/clamp. 2. Tighten all hose clamps. 3. Refer to diagram for correct hose connections. 4. Check o-ring and manifold; replace as required.

SECTION 8 REPLACEMENT PARTS

8.1 FRONT DOOR AND AUGER PARTS

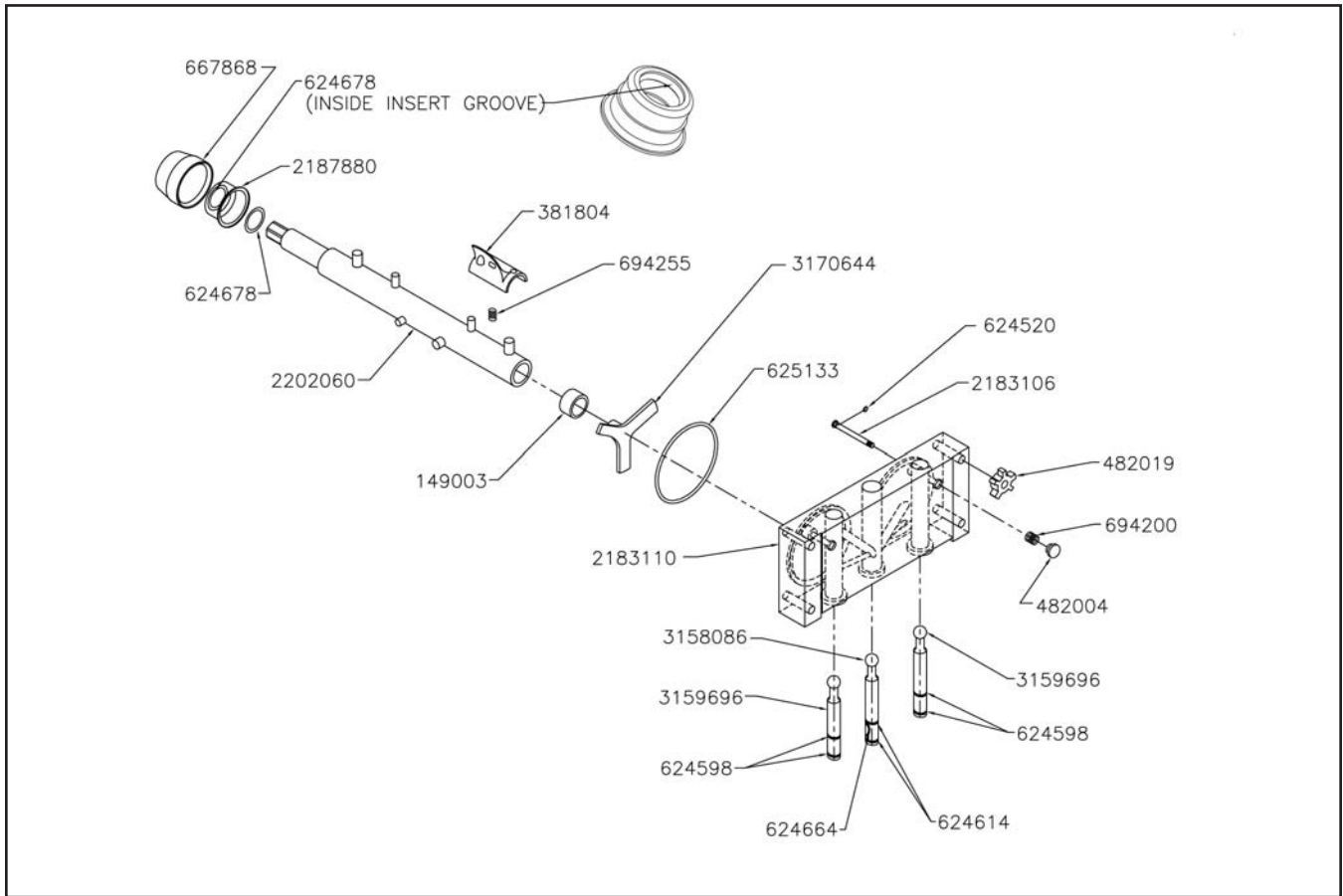

* If you are replacing a front door without side grooves, the spigot extensions and rosette caps also need to be replaced.

Part Number	Description	Quantity
149003	Bushing - Front Auger Support	2
381804	Auger Flight (Has 4 per Barrel)	8
482004	Knob (Air Bleed Valve & Spigot Body Adjustment)	2
482019	Knob - Front Door (Black)	4
624520-5	O-Ring - Air Bleed Valve - Black (5 Pack)	2
624598-5	O-Ring - Outside Spigot - Black (5 Pack)	4
624614-5	O-Ring - Top & Bottom Center Spigot - Black (5 Pack)	2
624664-5	O-Ring - Middle Center Spigot - Black (5 Pack)	1
624678-5	O-Ring - Rear Seal - Black (5 Pack)	4
625133	O-Ring - Front Door - Red	2
667868	Seal - Rear Auger (Orange)	2
694200	Spring - Air Bleed Valve	2
694255	Spring - Auger Flight	8
2183106	Valve - Air Bleed	2
2183110	Door w/Pins	1
2187880	Adapter - Rear Seal	2
2202060	Auger Shaft	2
2202347	Auger Shaft Kit (Includes Shaft, Insert & O-Ring)	-
3158086	Spigot Body - Center	1
3159696	Spigot Body - Outer	2
3170644	Support - Front Auger	2

8.2 CAB TUBING ASSEMBLY

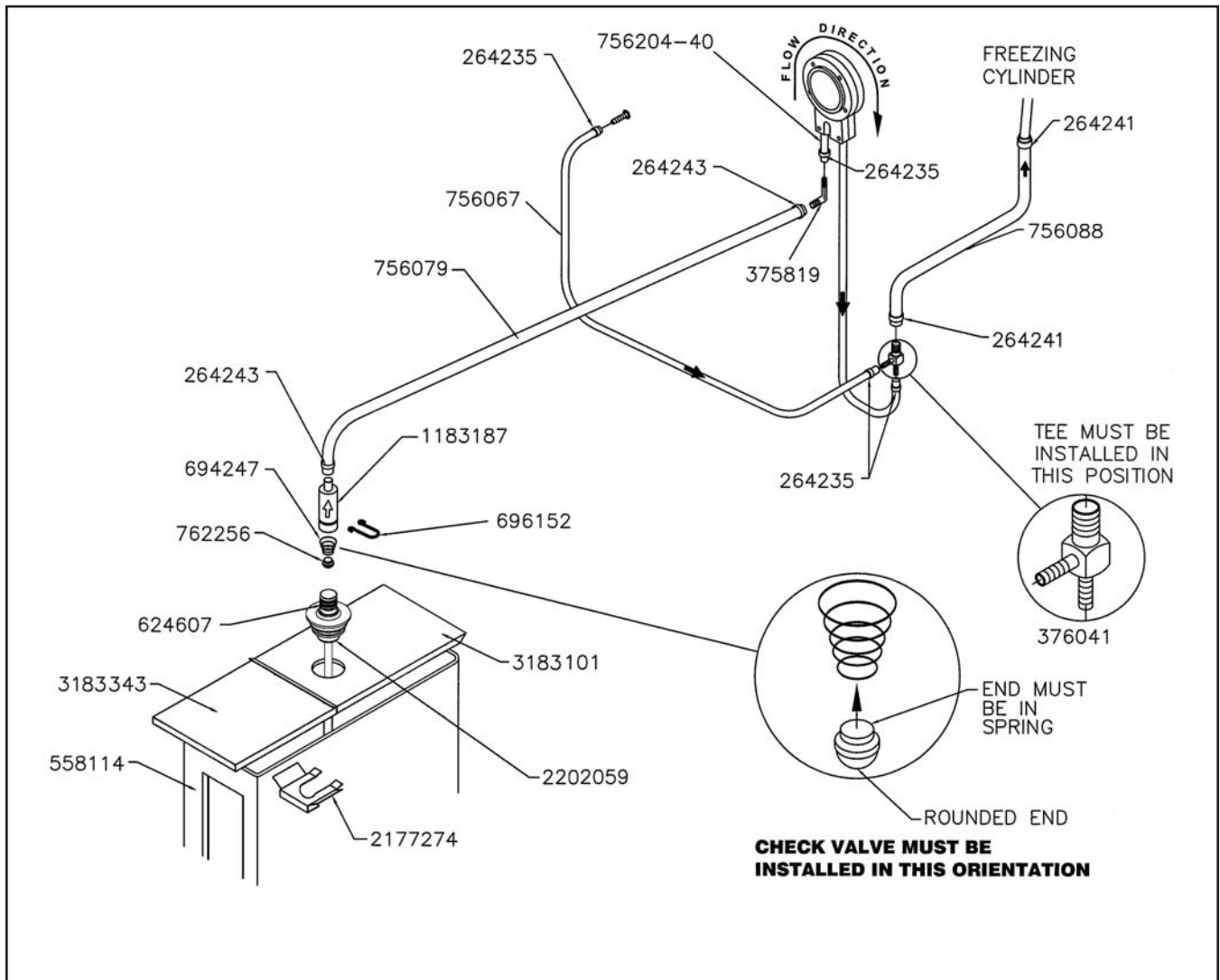

Part Number	Description	Quantity
264235	Clamp - Metal (1/4" ID Tubing)	10
264241	Clamp - Metal (1/2" ID Tubing)	4
264243	Clamp - Metal (3/8" ID Tubing)	4
375819	Elbow - Barbed (3/8" - 1/4")	2
376041	Tee Connector - 3-Way (Stainless)	2
558114	Mix Container Only	2
624607-5	O-Ring - Check Valve Body - Black (5 Pack)	2
694247	Spring - Cone (Cab Check Valve)	2
696152	Clip - Lock (Check Valve)	2
756067	Tubing - 1/4" ID - Clear - Air Line (25' Increments) (Per Inch)	Two 7" & Two 9"
756079	Tubing - 3/8" ID - Clear - Mix Line (25' Increments) (Per Inch)	Two 24"
756088	Tubing - 1/2" ID - Clear - Mix Line (25' Increments) (Per Inch)	Two 6"
756204	Tubing - 1/4" ID - Pump (50' Box Only) (Per Inch)	-
756204-40	Tubing - 1/4" ID - Pump (Pre-Cut 40" Piece)	2
762256	Check Valve - Mix Outlet	2
1183187	Check Valve - Mix In Line	2
2177274	Clip - Retaining (Mix Probe To Cover)	2
2202059	Pick-Up Tube - Mix	2
3183101	Cover - Rear (Mix Container)	2
3183343	Cover - Front (Mix Container)	2

8.3 SPIGOT CAM ASSEMBLY

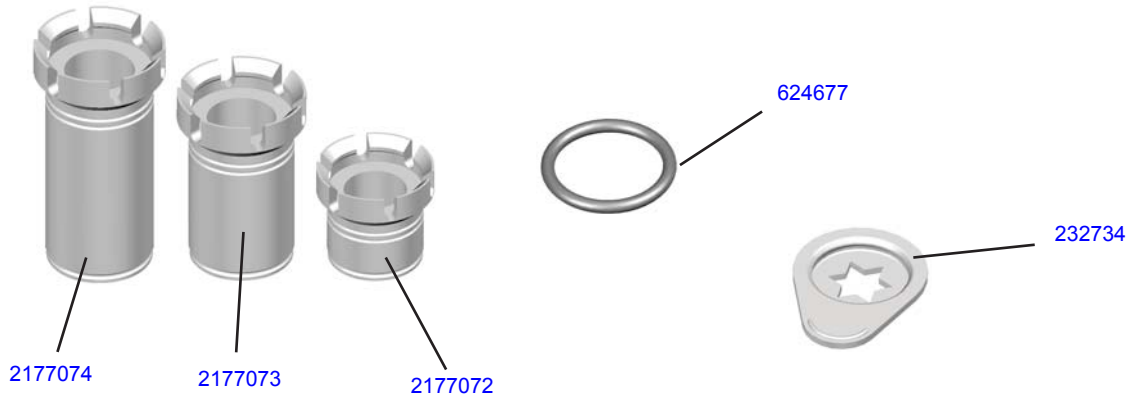
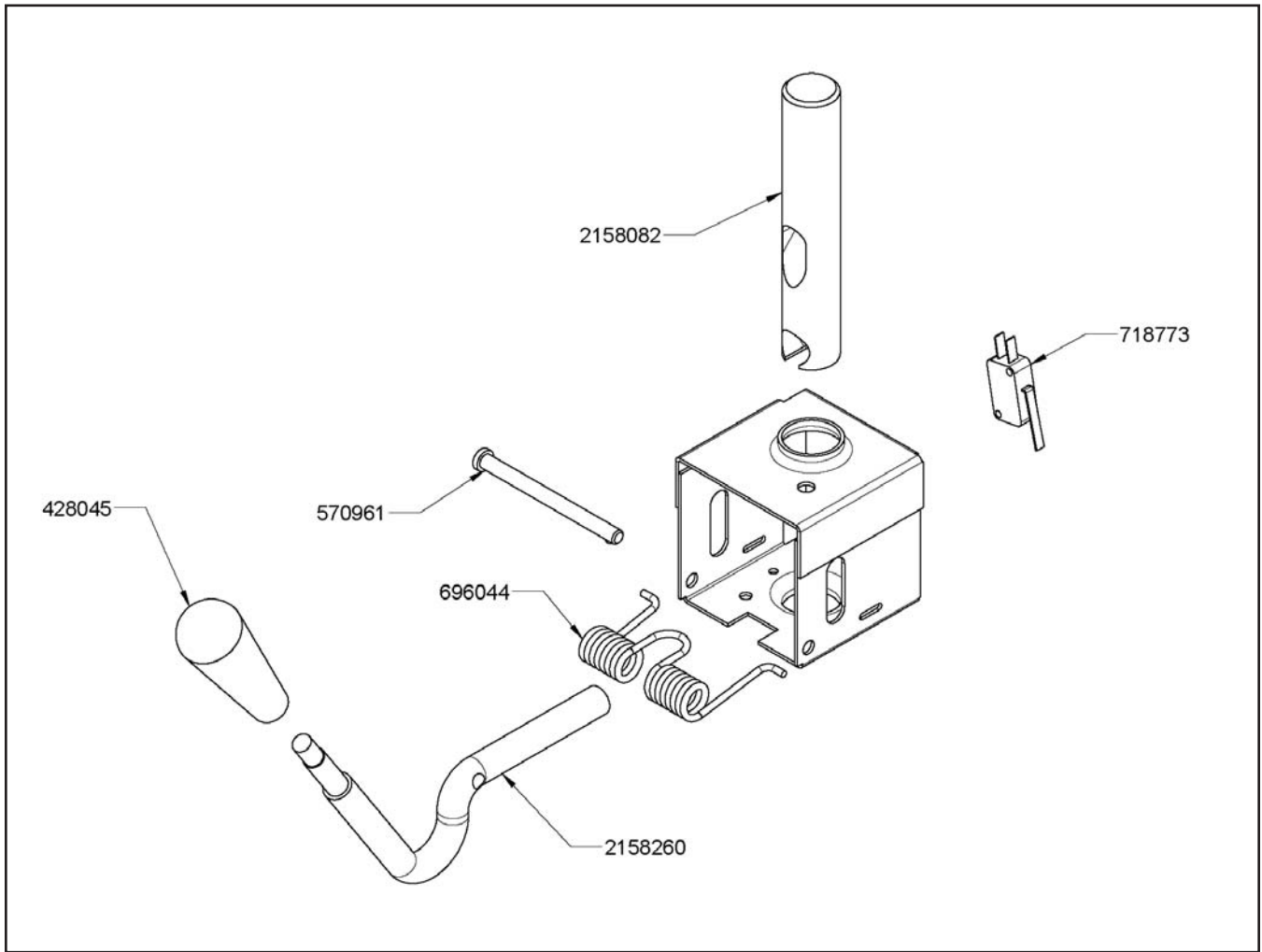

Part Number	Description	Quantity
232734	Cap - Rosette	4
428045	Knob - Spigot Handle (Black)	3
570961	Pin - Cotterless Clevis (Spigot Cam)	3
624677-5	O-Ring - Spigot Extension - Black (5 Pack)	3
696044	Spring - Torsion (Spigot Cam)	3
718773	Switch - Spigot Cam	4
2158082	Glide - Spigot Socket	3
2158260	Handle - Spigot (Metal Only)	3
2177072	Extension - Spigot - 1.5"	0
2177073	Extension - Spigot - 2.5"	3
2177074	Extension - Spigot - 3.2"	0

8.4 REAR

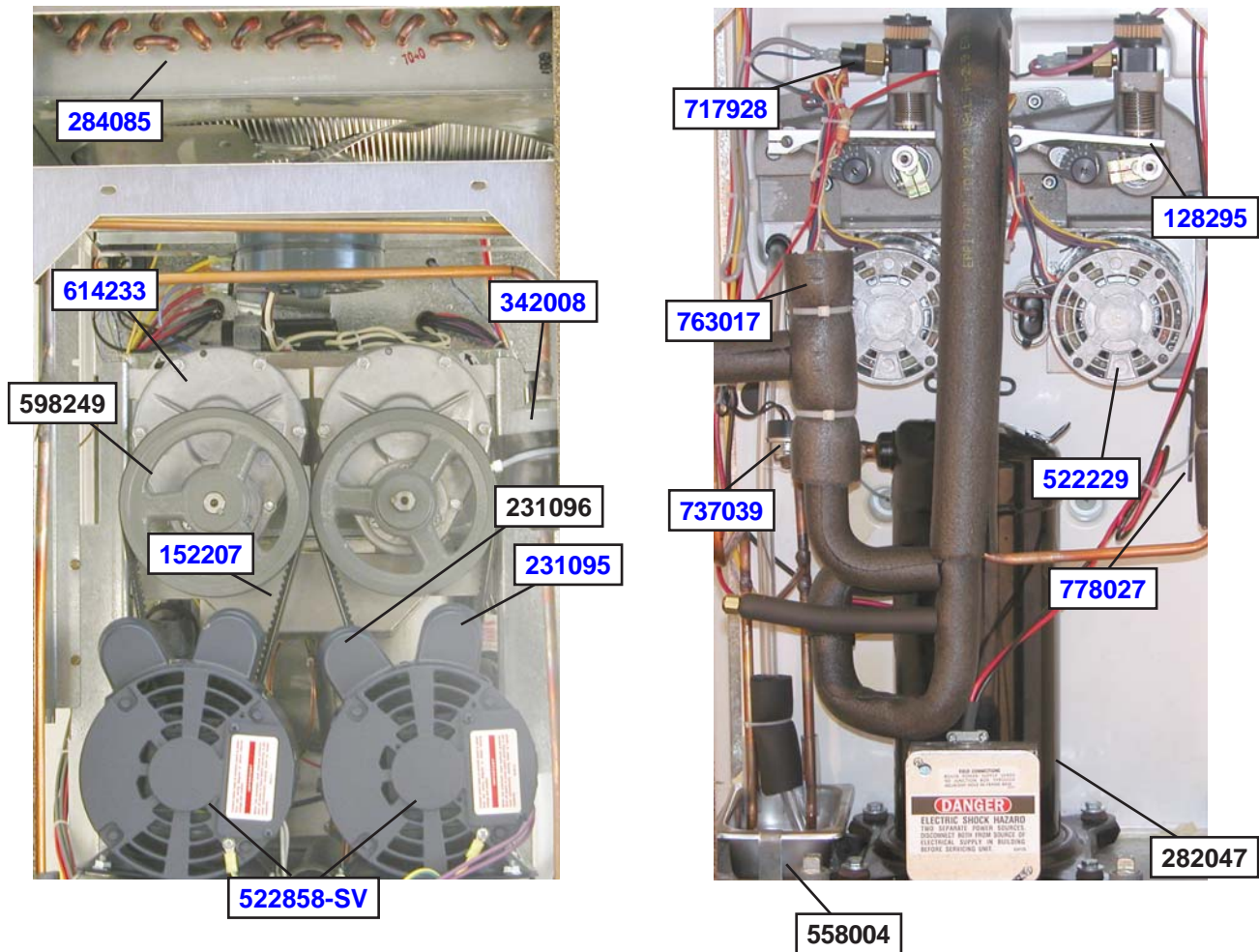

Part Number	Description	Quantity
128295	Rocker Arm Assembly w/Screw (Cab)	2
152207	Belt - Grip-Notch (AX-29) (Each)	2
231078	Capacitor - Run (#522858 Motor)	2
231095	Capacitor - Start (#522858 Motor)	2
282047	Compressor - 1 PH - 60 Hz	1
284085	Condenser (Air-Cooled)	1
284104	Condenser (Water-Cooled)	1
342008	Drier (Liquid Line)	1
368325	Filter - Air (Condenser)	1
450061	Water Hose (Per Inch) (Water-cooled)	0
522229	Motor - Pump (Cab)	1
522858-SV	Motor - Drive	2
558004	Condensate Pan	1
598249	Pulley - Speed Reducer	2
614233	Speed Reducer	2
647899	Screw - Panel (Side, Top, Rear & Front Shroud) & Cab (Top Hinge)	0
717928	Switch - Pressure (Pump) (Cab)	2
737039	Thermostat - Discharge Line	1
763017	Valve - Hot Gas Bypass	1
763181	Valve - Water	1
778027	Wrench - Allen (Cab)	2
4183066	Evaporator Assembly	1

8.5 RIGHT HAND SIDE AND HEADER PANEL

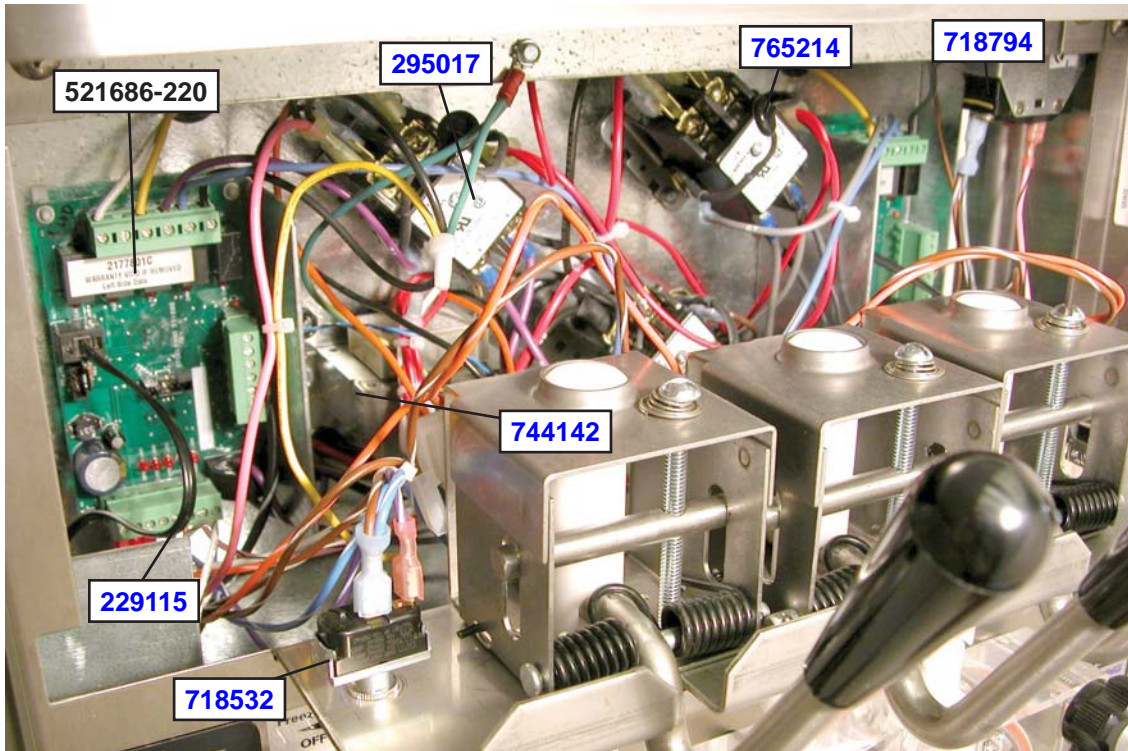
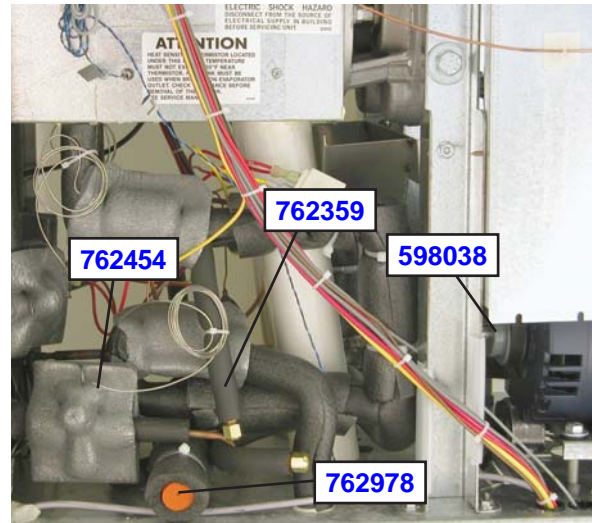
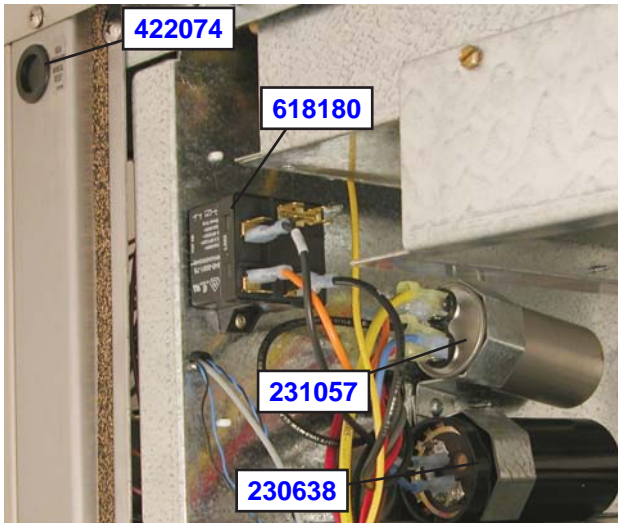

Part Number	Description	Quantity
229115	Cable - Phone (Control Board to Display Board)	2
230638	Capacitor - Start (#282047 Compressor)	1
231057	Capacitor - Run (#282047 Compressor)	1
295017	Contactors (45CG20AG) (Drive Motor / Compressor / Cab)	3
422074	Grommet - Rubber (Reset)	1
521686-230	Program Board - IntelliTec (208V / 230V)	2
598038	Pulley - Drive Motor	2
618180	Relay (Compressor)	1
718532	Switch - Toggle (Freezing Cylinder On-Off)	2
718776	Switch - Door Interlock	1
718794	Switch - High Pressure Cutout	1
744142	Transformer	1
762359	Valve Core (Schrader)	0
762454	Valve - Expansion (Has 2)	2
762978	Valve - EPR (Cab)	1
765214	Varistor Harness	6
3183217	Display Mounting Plate	2

8.6 LEFT HAND SIDE & CAB INTERIOR

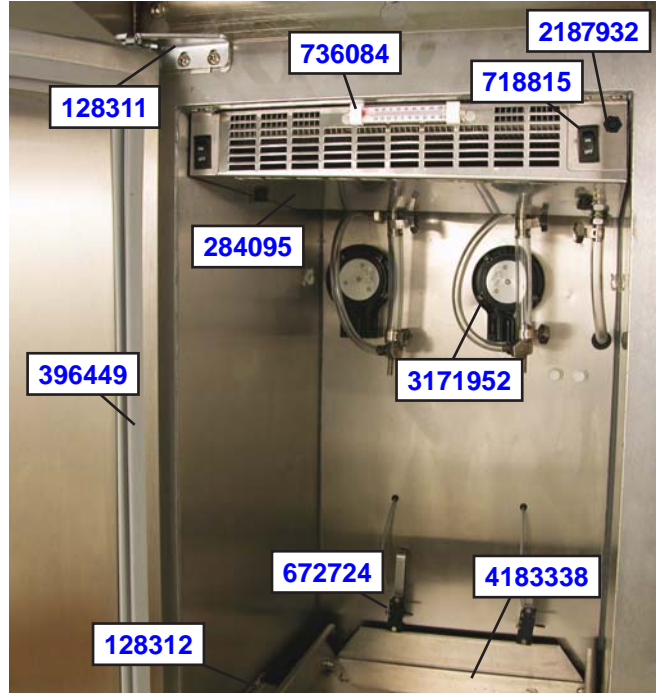
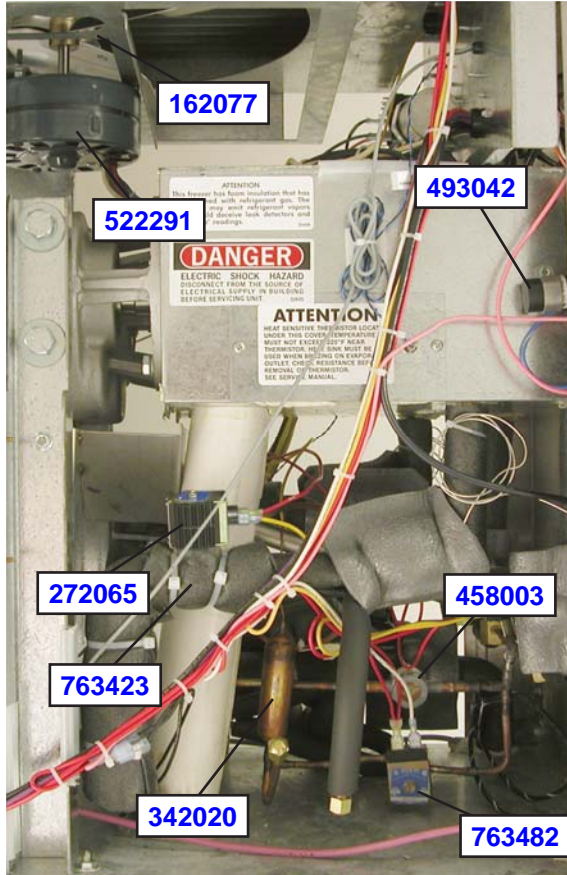

Part Number	Description	Quantity
128311	Hinge - Door (Top & Bottom) (Cab)	2
128312	Mix Container Holder Assembly w/Rollers (Cab)	1
162048	Blade - Fan (Evaporator) (Cab)	1
162077	Blade - Fan (Air-Cooled Condenser)	1
231106	Cap Tube Only	1
266018	Clip - "J" (Hose Holder) (Cab)	2
272065	Valve Coil - Solenoid (#763423)	2
284095	Evaporator (Cab)	1
342020	Drier	1
396449	Gasket - Door (Cab)	1
423037	Guard - Fan (Cab)	1
458003	Indicator - Liquid Line	1
493042	Flasher - Indicator Light (Cab On - Off)	1
522291	Motor - Fan (Air-Cooled Condenser)	1
558114	Mix Container Only (Cab)	2
672724	Sensor - Capacitive (Cab)	2
718815	Switch - Rocker (Pump) (Cab)	2
736084	Thermometer (Cab)	1
762275	Valve - Magna Check (Cab)	3
762457-SV	Valve - Expansion (w/Orifice) (Cab)	1
763422	Valve - Solenoid (Liquid Line) (Has 3)	3
763423	Valve - Solenoid (Suction Line) (Has 2)	2
763482	Valve Coil - Solenoid (#763422)	3
1187428	Motor - Fan (Evaporator Assembly) (Cab)	1
2187932	Switch - Pushbutton (Cab Door) (Cab)	1
3171952	Cover - Clamp (Two Piece Black) (Cab)	2
3177231	Handle - Door (Cab)	1
3183101	Cover - Rear (Mix Container) (Cab)	2
3183343	Cover - Front (Mix Container) (Cab)	2
4183338	Mix Container Drawer (Cab)	2

8.7 FRONT PANEL

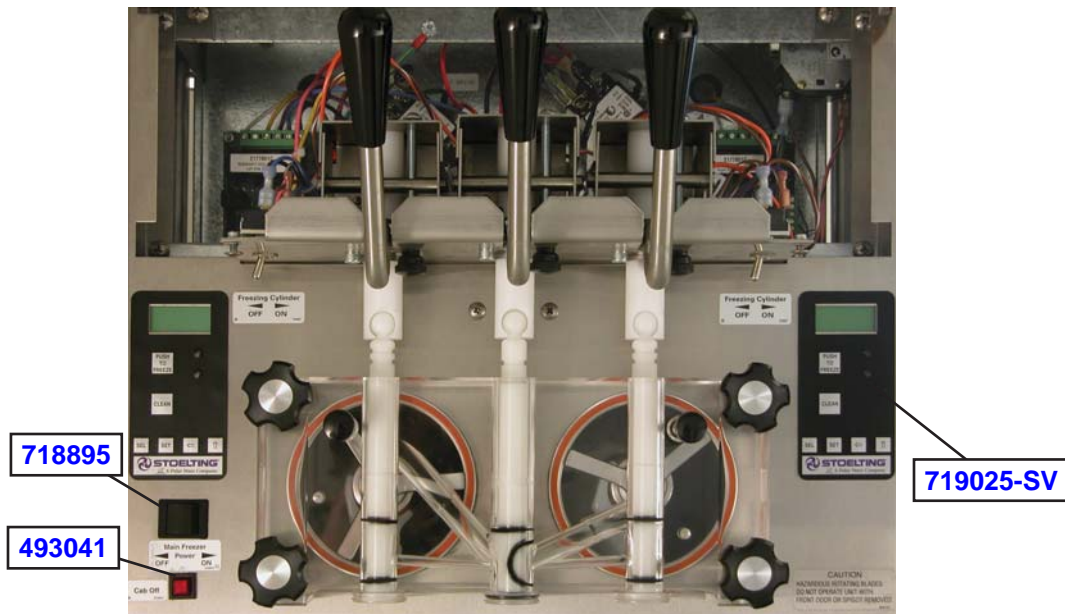

Part Number	Description	Quantity
332541	Board - Display Module (Display Only) (See #3183217)	2
493041	Indicator Light (Cab On - Off)	1
718895	Switch - Rocker (Cab On-Off)	1
719025-SV	Switch - Membrane Strip	2

8.8 PART KITS

Part Number	Description	Quantity
1177436	Air Compressor Kit (Reed Valve, Piston & Cylinder Sleeve) (Cab)	-
1171860	Valve Spring	1
1171861-SV	Needle Valve w/O-Ring	1
1171863	Valve Guide	1
1171864	O-Ring	1
128296	Piston & Cylinder Sleeve	1
1183624	O-Ring & Bearing Kit	-
149003	Bearing - Front Auger Support	2
624520	O-Ring - Air Bleed Valve - Black	3
624598	O-Ring - Outside Spigot - Black	5
624607	O-Ring - Check Valve Body - Black	6
624614	O-Ring - Top & Bottom Center Spigot - Black	4
624664	O-Ring - Middle Center Spigot - Black	3
624677	O-Ring - Spigot Extension - Black	4
624678	O-Ring - Rear Seal - Black	5
625133	O-Ring - Front Door - Red	2
2177917	Brush Kit	-
208135	Brush - 4" x 8" x 16" (Barrel)	1
208380	Brush - 1/4" x 3" x 14"	1
208387	Brush - 1/2" x 5" x 24"	1
208401	Brush - 1" X 3" X 10"	1
208465	Brush - 1" x 3-1/2" x 18"	1
208467	Brush - 3/8" x 1" x 5"	1
764385	Valve Kit - Water Valve Repair	-
1177990	Caster Kit - 4" (Set of 4)	-
2171962	Sensor Probe Kit	-
2177812	Roller Carrier Assembly Kit (Cab)	-

8.9 PUMP PARTS

Part Number	Description	Quantity
376035	Tee Connector - Air Pressure Switch	2
432003-SV	Valve Head Only w/Tubes	2
522229	Motor - Pump	2
538306	Nut - Motor Mounting	8
644065	Screw - Rocker Arm	2
650146	Set Screw - Pulley	4
652412	Screw - Shoulder (Crank Arm Roller Assembly)	2
653042	Screw - Thumb (Cover Clamp)	8
667896	Seal - Bumper (Piston)	2
717928	Switch - Pressure	2
762246	Check Valve - Air Line (Stainless)	2
766058	Washer - Lock - Motor Mounting	8
1171860	Spring - Check Valve	2
1171861-SV	Needle Valve w/o Ring	2
1171862	Screw - Air Filter Retainer	2
1171863	Valve Guide	2
1171864	O-Ring - Needle Valve	2
1171866	Screw - Valve Head	10
1171867	O-Ring (Pump Cylinder Sleeve)	2
1171868	Reed Valve	2
1171870	Cylinder Sleeve	2
1171871	Spring - Piston	2
1171872	Piston Spring Seat	2
1171873	Piston	2
1171874	Ball Bearing - Single (Pump Rocker Arm)	2
1171955	Set Screw - Eccentric	2
1171956	Washer - Crank Arm - Nylon	2
1171958	Filter - Air	2
1171959	O-Ring (Piston)	2
1171977	Roller (Crank Arm)	2
1171978	Screw - Crank Arm	2
1171979	Crank Arm	2
1171980	Pulley - Large	2
1171981	Eccentric	2
1171982	Knob - Crank Arm Overrun Setting	2
1171983	Dial - Crank Arm Overrun Setting	2
1171984	Pointer - Crank Arm Overrun Setting	2
1171985	Dowel Pin - Rocker Arm	2
1171986	Flange Bearing - Rocker Arm	4
1171987	Wick - Rocker Arm	2
1171988	Collar - Rocker Arm Dowel Pin	2
1171989	Pulley - Small	2
1171990	Belt	2
1171994	Sleeve Bearing - Crank Arm	2
1177033	Bumper Ring (Piston)	2
1177034	Air Filter Retainer - Top	2
1177035	Air Filter Retainer - Bottom	2
1177036	Washer - Air Filter Retainer	2
1177037	Screw - Air Filter	2
1177681	Rocker Arm	2
1183283	Fitting - Barbed - Air Inlet	2
2177812	Roller Carrier Assembly Kit	2
2183067	Pump Body Casting	2
3171952	Cover - Clamp (Two Piece Black)	2
3177813	Roller Carrier & Shaft Assembly Kit	2
4183089	Pump Assembly w/Motor	-

8.9 PUMP PARTS (CONTINUED)

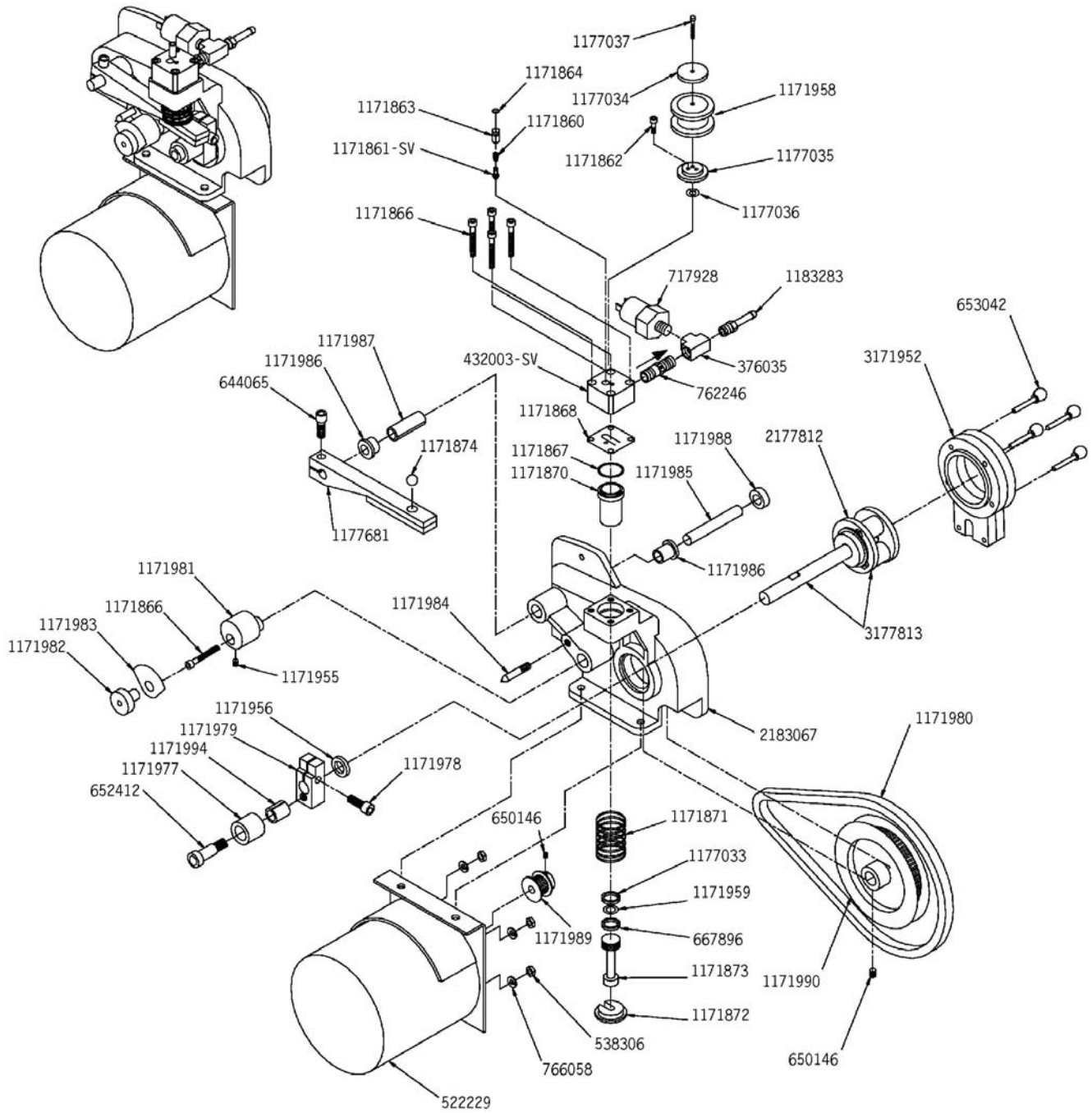

8.10 DECALS & MISCELLANEOUS PARTS

Part Number	Description	Quantity
324014	Decal - Black Arrow on White Back	-
324065	Decal - Water Inlet	-
324103	Decal - Caution Rotating Shaft	-
324106	Decal - Caution Electrical Wiring Materials	-
324107	Decal - Caution Hazardous Moving Parts	-
324125	Decal - Danger Electric Shock Hazard	-
324141	Decal - Caution Rotating Blades	-
324200	Decal - High Pressure Cut-Out	-
324208	Decal - Attention Refrigerant Leak Check	-
324346	Decal - Caution Hazardous Moving Parts	-
324477	Decal - Electrical Box - R.H.	1
324478	Decal - Electrical Box - L.H.	1
324509	Decal - Cleaning Instructions	-
324566	Decal - Wired According To	-
324584	Decal - Adequate Ventilation 3"	1
324686	Decal - Danger Automatic Start	4
324799	Decal - Pump Off / On	2
324803	Decal - Domed Stoelting Logo (Large) (Header Panel)	1
324804	Decal - Domed Stoelting Swirl (Header Panel)	1
324825	Decal - Main Freezer Power	1
324826	Decal - Cab Off	1
324827	Decal - Freezing Cylinder	2
208135	Brush - 4" x 8" x 16" (Barrel)	1
208380	Brush - 1/4" x 3" x 14"	1
208387	Brush - 1/2" x 5" x 24"	1
208465	Brush - 1" x 3-1/2" x 18"	1
208467	Brush - 3/8" x 1" x 5"	1
236050	Card - Cleaning Instruction	1
417006	Grid - Drip Tray (Metal)	1
513604	Manual - Owner's	1
508048	Lubricant - Spline (2 oz Squeeze Tube)	1
508135	Petro Gel - 4oz Tube	1
744273	Tray - Drip	1

8.11 STAINLESS STEEL PANELS

Part Number	Description	Quantity
647653	Screw - Header Panel, Cab, Door Handle & Cab Bottom Hinge	0
4183071	Panel - Top (Air-Cooled)	1
4183072	Panel - Left Hand Side	1
4183073	Panel - Right Hand Side	1
4183074	Panel - Rear	1
4183085	Panel - Top (Water-Cooled)	1

8.12 REFRIGERATION DIAGRAM AND WIRING DIAGRAM

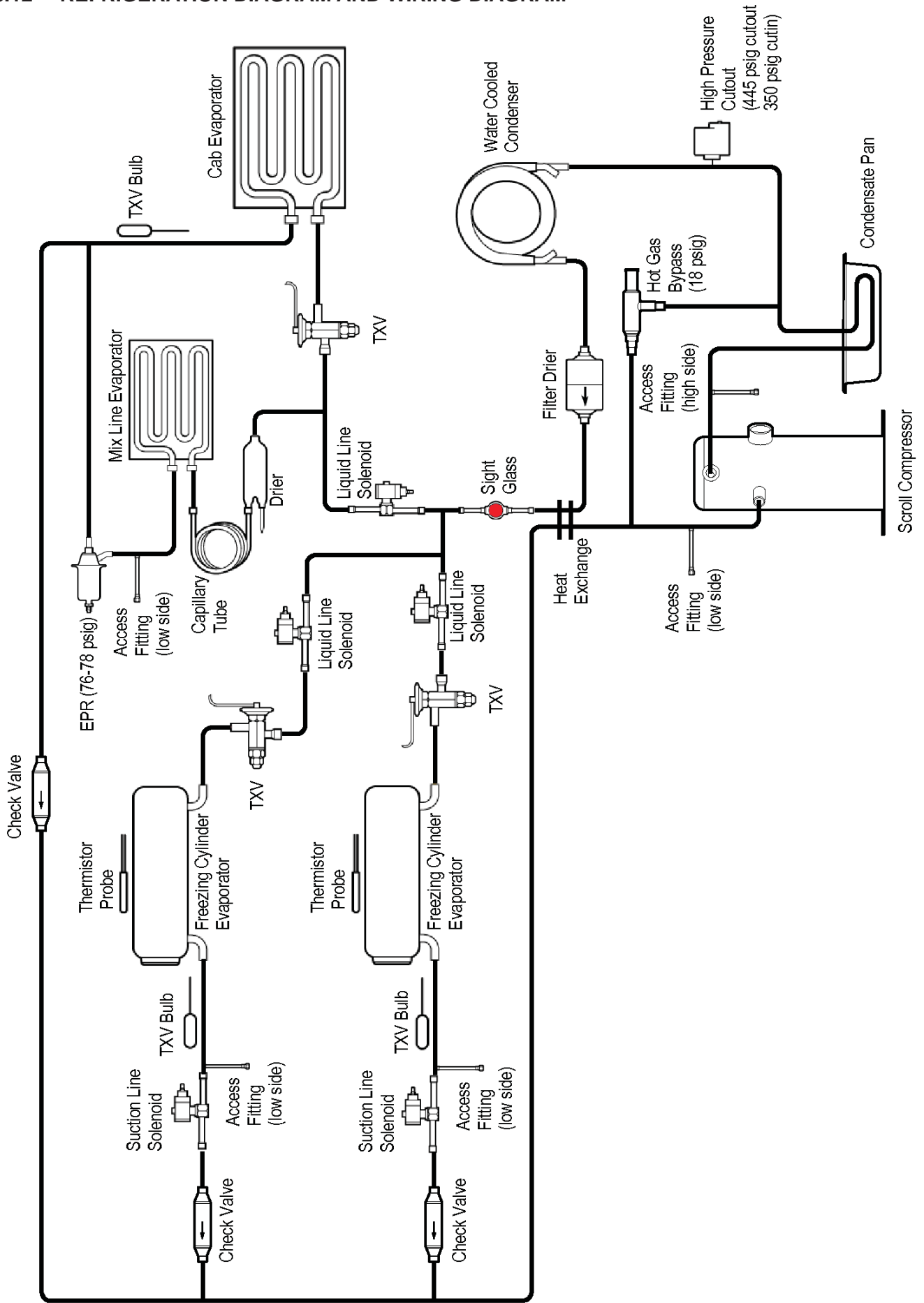

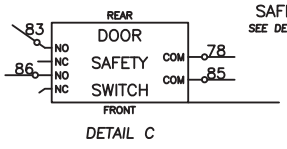
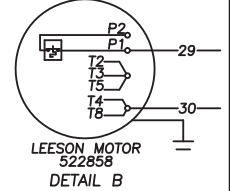
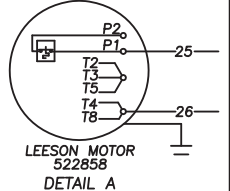
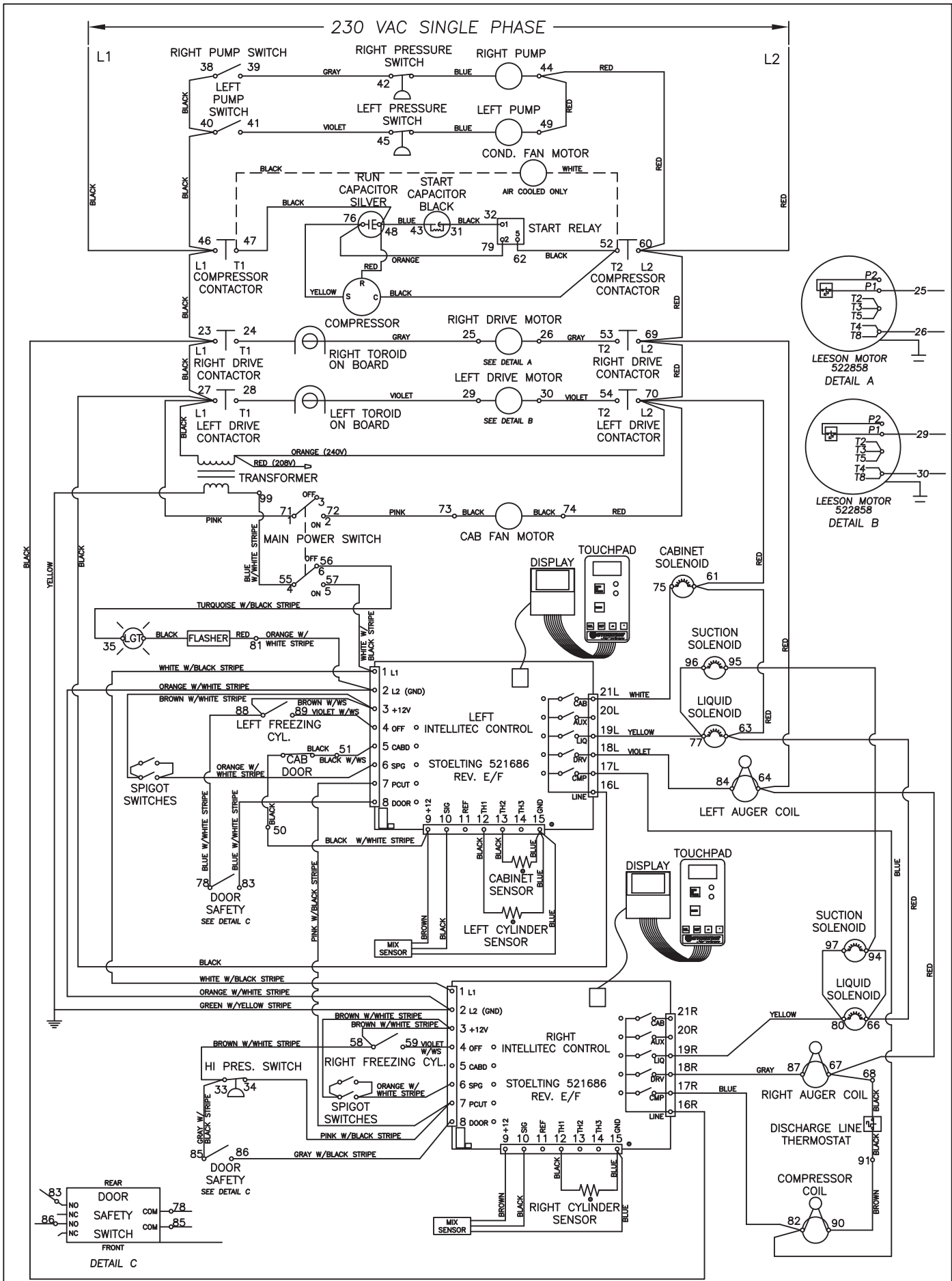

1. Scope:

Stoelting, A Vollrath Company (“Stoelting”) warrants to the first user (the “Buyer”) that the Stoelting-branded freezer equipment (the “Equipment”) will be free from defects in materials and workmanship under normal use and proper maintenance for the period listed below in the Warranty Period section. All warranty periods begin on the date of original install or one (1) year from the shipping date, whichever occurs first. This warranty is subject to all conditions, exceptions, and limitations contained herein.

2. Disclaimer of Other Warranties:

THIS WARRANTY IS EXCLUSIVE; AND STOELTING HEREBY DISCLAIMS ANY IMPLIED WARRANTY OF MERCHANTABILITY OR FITNESS FOR PARTICULAR PURPOSE.

3. Remedies:

Stoelting’s sole obligations, and Buyer’s sole remedies, for any breach of this warranty shall be, at Stoelting’s option, one of the following: repair or replacement of the affected component at Stoelting’s plant in Kiel, Wisconsin, or refund of the purchase price of the affected Equipment. Stoelting, through an Authorized Stoelting Provider, will deinstall/reinstall the affected component from/into the equipment (“Labor”) for the period listed below in the Warranty Period section. These obligations/remedies are subject to the conditions that Buyer (a) signs and returns to Stoelting, upon installation, the Start-Up and Training Checklist for the affected equipment, (b) gives Stoelting prompt written notice of any claimed breach of warranty within the applicable warranty period, and (c) delivers the affected equipment to Stoelting or its designated service location, in its original packaging/crating, also within that period. Buyer shall bear the cost and risk of shipping to and from Stoelting’s plant or designated service location.

4. Warranty Period:

Equipment	Part	Part Warranty Period	Labor Warranty Period
Soft Serve & Shake	Freezing Cylinders	Five (5) Years	Twelve (12) Months
	Hoppers		
	Compressors		
	Drive Motors		
	Speed Reducers		
	Augers		
Frozen Uncarbonated Beverage	Evaporator	Five (5) Years	Twelve (12) Months
	Compressors		
	Drive Motors		
	Speed Reducers		
Custard & Batch	Freezing Cylinders	Two (2) Years	Twelve (12) Months
	Hoppers		
	Compressors		
	Drive Motors		
	Speed Reducers		
	Beaters Auger Shafts		
Dipping Cabinets & Display Cabinets	All components	Twelve (12) Months	Twelve (12) Months
Frozen Beverage / Granita Dispenser	Compressors	Five (5) Years	Twelve (12) Months
	Electronic Board	Three (3) Years	
	All other components	Two (2) Years	
AutoVend	All components	Twelve (12) Months	Twelve (12) Months
Crème Whippers	Compressors	Two (2) Years	Twelve (12) Months
	Motors		
	Condensers		
All equipment	All other components not specified above	Twelve (12) Months	Twelve (12) Months

5. **Conditions:**

- a) If the date of the original installation cannot be verified, these warranty periods begin one (1) year from the shipping date. It is the responsibility of the seller to disclose this information to the Buyer at the time of sale.
- b) Stoelting shall not be responsible to provide any remedy under this warranty with respect to any component that fails by reason of negligence, abnormal use, misuse or abuse, faulty repair made by others, use with parts or equipment not manufactured or supplied by Stoelting, any modification or alteration of any parts or equipment, or damage in transit.
- c) This warranty is valid only if the Equipment is installed and serviced by an Authorized Stoelting Provider and only if new, genuine Stoelting parts are used.
- d) The Equipment installation location must have suitable conditions as explained in the Stoelting operators manual, specification sheet, and/or technical manual including but not limited to, ambient temperature, water supply parameters, and space requirements.
- e) The Authorized Stoelting Provider must return defective parts, at Stoelting's discretion, for credit.
- f) Any refrigerant other than that specified on the Equipment model identification nameplate voids this warranty.

6. **Exceptions:**

This warranty does **NOT** cover any of the following

- a) Costs associated with installation labor, disposal of equipment being replaced, and shipping costs of replacement parts or Equipment.
- b) Cleaning, maintenance or lubrication of the Equipment as outlined in the Stoelting operators manual.
- c) This warranty does not extend to parts, sometimes called "wear parts", which are generally expected to deteriorate and to require replacement as equipment is used, including but limited to o-rings, auger flights, auger seals, auger support bushings, and drive belts. All such parts are sold **AS IS**.
- d) External components including but not limited to hoses, piping, or electrical equipment.
- e) Labor and travel charges due to return trips or waiting if the Authorized Stoelting Provider is prevented from promptly starting service work upon arrival. This exception includes labor charges incurred for limited access facilities including, but not limited to, government and military buildings, and airports.
- f) Failure, damage, or repairs due to faulty installation, misapplication, abuse, lack of service, or improper service, unauthorized alteration, improper operation as indicated in the Stoelting operators manual, including but not limited to failure to properly assemble and/or clean, improper tool usage, or use of unapproved lubrication, or cleaning and sanitizing supplies.
- g) Any costs associated with electricity, including utility increases, from any reason whatsoever.
- h) Damage resulting from the use of refrigerant other than that specified on the Equipment model identification nameplate.
- i) The use of this equipment as a rental asset negates all warranties associated with the equipment.
- j) Any special, indirect or consequential property or commercial damage of any nature whatsoever, if the jurisdiction allows this exclusion.
- k) Costs not covered by the Stoelting Travel Pay policy. Stoelting covers only the first trip travel which is a flat rate by mileage one-way from the service company's home location to the job site. The flat rate is calculated as follows:
 - o 0-50 Miles \$85
 - o 51-110 Miles \$127
 - o 111-160 Miles \$165
 - o Over 160 Miles The maximum reimbursed by Stoelting is \$165

Any travel costs not covered may be invoiced to the customer.

7. **Limitations:**

THE REMEDIES SET FORTH IN THIS WARRANTY SHALL BE THE SOLE LIABILITY STOELTING AND THE EXCLUSIVE REMEDY OF BUYER WITH RESPECT TO EQUIPMENT SUPPLIED BY STOELTING; AND IN NO EVENT SHALL STOELTING BE LIABLE FOR ANY INCIDENTAL OR CONSEQUENTIAL DAMAGES, INCLUDING AS EXAMPLES BUT NOT INTENDED TO BE LIMITED TO DOWNTIME, OVERHEAD, MATERIALS, PERFORMANCE PENALTIES, LOST SALES, LOST PROFITS, PRODUCT LOSS, OR PROPERTY DAMAGES, WHETHER FOR BREACH OF WARRANTY OR OTHER CONTRACT BREACH, NEGLIGENCE OR OTHER TORT, OR ON ANY STRICT LIABILITY THEORY.