

# **Pro-Max<sup>®</sup>**

## **SPLIT LID TABLE TOP TWO SIDED GRILL**

MODEL  
CG14SPT, CG14STE, CG14SPTI, CG14SPTIG  
GR14SPTA, GR14SPTC, GR14STE  
GR14SPTK, GR14SPTI, GR14SPTIP

### **Installation and Operation Instructions**

2M-Z5818 Rev. N 1/14/2013



GR14SPT



## SAFETY SYMBOL



These symbols are intended to alert the user to the presence of important operating and maintenance instructions in the manual accompanying the appliance.

---

## RETAIN THIS MANUAL FOR FUTURE REFERENCE NOTICE

Using any part other than genuine Star factory supplied parts relieves the manufacturer of all liability.

Star reserves the right to change specifications and product design without notice. Such revisions do not entitle the buyer to corresponding changes, improvements, additions or replacements for previously purchased equipment.

Due to periodic changes in designs, methods, procedures, policies and regulations, the specifications contained in this sheet are subject to change without notice. While Star International Holdings Inc., Company exercises good faith efforts to provide information that is accurate, we are not responsible for errors or omissions in information provided or conclusions reached as a result of using the specifications. By using the information provided, the user assumes all risks in connection with such use.

## MAINTENANCE AND REPAIRS

Contact your local authorized service agent for service or required maintenance.

Please record the model number, serial number, voltage and purchase date in the area below and have it ready when you call to ensure a faster service.

Model No. \_\_\_\_\_  
Serial No. \_\_\_\_\_  
Voltage \_\_\_\_\_  
Purchase Date \_\_\_\_\_

### Authorized Service Agent Listing

Reference the listing provided with the unit

OR

for an updated listing go to:

**Website:** [www.star-mfg.com](http://www.star-mfg.com)  
**E-mail** [Service@star-mfg.com](mailto:Service@star-mfg.com)

### Service Help Desk

**Business Hours:** 8:00 am to 4:30 p.m. Central Standard Time

**Telephone:** (314) 678-6303

**Fax:** (314) 781-2714

**E-mail** [Parts@star-mfg.com](mailto:Parts@star-mfg.com)  
[Service@star-mfg.com](mailto:Service@star-mfg.com)  
[Warranty@star-mfg.com](mailto:Warranty@star-mfg.com)

**Website:** [www.star-mfg.com](http://www.star-mfg.com)

**Mailing Address:** Star International Holdings Inc., Company  
10 Sunnen Drive  
St. Louis, MO 63143  
U.S.A

# GENERAL SPECIFICATIONS

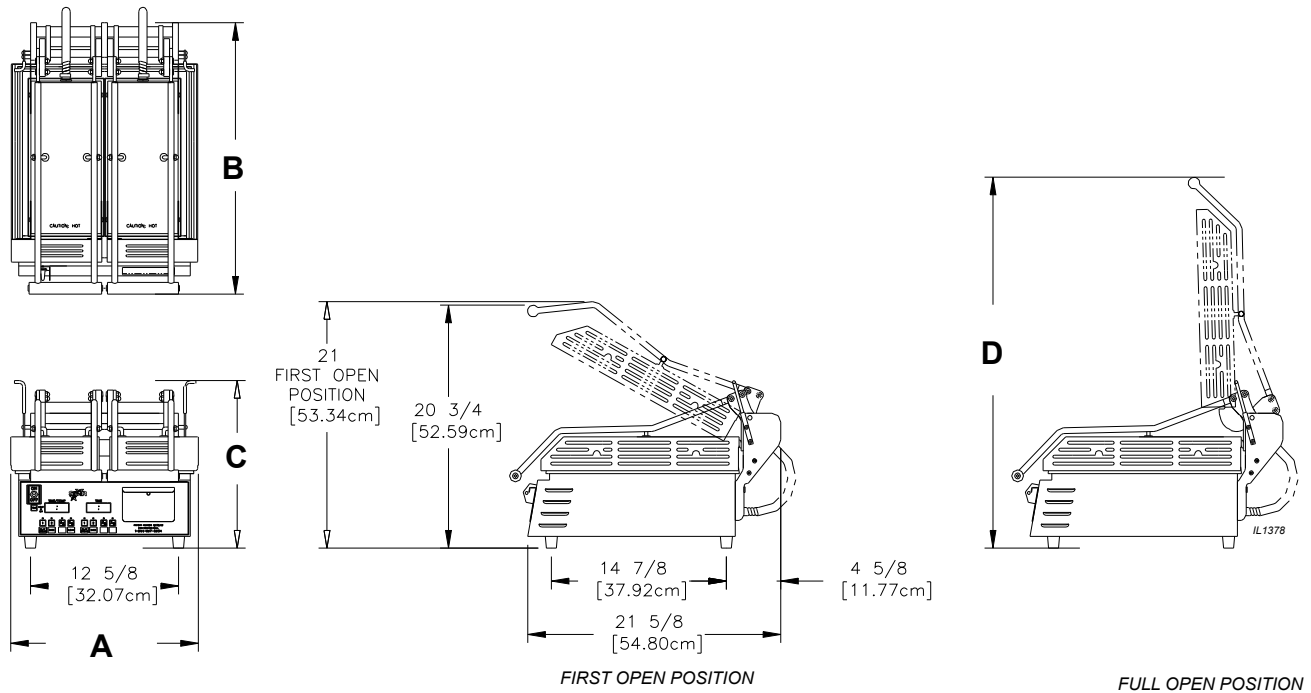

Model No	Grill Surface	(A) Width Inches (cm)	(B) Depth Inches (cm)	© Closed Inches (cm)	(D) Open Inches (cm)	Voltage	Wattage	Amps	NEMA Plug	Approximate Weight			
										Shipping lbs. (kg)	Installed lbs. (kg)		
CG14SPT-120C	Aluminum	16" (40.6)	23 1/8" (58.7)	14 1/4" (36.3)	31 5/8" (80.3)	120	2,300	19.2	5-30P	81 (37.8)	68 (30.9)		
CG14SPT-120V						120	2,300	19.2	5-20P				
CG14SPT-230V						230	2,112	9.2	IEC 320				
CG14SPT-240V						240	2,300	9.6	6-15P				
CG14SPTI-240	Iron			17 1/4" (43.8)	34 5/8" (87.9)	240	3,550	14.8	6-20P				
CG14SPTI-ARB													
CG14SPTID240													
CG14SPTIG240													
CG14SPTIS240													
CG14SPTK-120	Aluminum			14 1/4" (36.3)	31 5/8" (80.3)	120	2,300	19.2	5-20P				
CG14SPTK120C									5-30P				
CG14STKE-120									5-20P				
GR14SPTA-120									5-20P				
GR14SPTA120C									5-30P				
GR14SPTA-240									6-15P				
GR14SPTA-CE									IEC 320				
GR14SPTC-120		Chrome	17 1/4" (43.8)						34 5/8" (87.9)	120	2,300	19.2	5-20P
GR14SPTC-240													6-15P
GR14SPTI-240		Iron	17 1/4" (43.8)						34 5/8" (87.9)	240	3,550	14.8	6-20P
GR14SPTIP240	6-20P												
GR14SPTI-230	IEC 320												
GR14SPTK-120	Aluminum	14 1/4" (36.3)	31 5/8" (80.3)	120	2,300	19.2	5-20P						
GR14SPTK120C							5-30P						
GR14STE-120							5-20P						
GR14STE-120V							5-20P						
GR14STE-230							IEC 320						
GR14STKE-120							5-20P						
GR14SPTKM-UK							IEC 320						



## GENERAL INSTALLATION DATA

This equipment is designed and sold for commercial use only by personnel trained and experienced in its operation and is not sold for consumer use in and around the home nor for use directly by the general public in food service locations.

Before using your new equipment, read and understand all the instructions & labels associated with the unit prior to putting it into operation. Make sure all people associated with its use understand the units operation & safety before they use the unit.

All shipping containers should be checked for freight damage both visible and concealed. This unit has been tested and carefully packaged to insure delivery of your unit in perfect condition. If equipment is received in damaged condition, either apparent or concealed, a claim must be made with the delivering carrier.

Concealed damage or loss - if damage or loss is not apparent until after equipment is unpacked, a request for inspection of concealed damage must be made with carrier within 15 days. Be certain to retain all contents plus external and internal packaging materials for inspection. The carrier will make an inspection and will supply necessary claim forms.

## INSTALLATION

1. This two sided grill is equipped for the voltage shown on the nameplate. It will operate on alternating current only, however the specified voltage must be applied.
2. 120 volt units **must** be plugged into a dedicated 120 VAC line with a 20 Amp receptacle. 230-240 volt units do not require a dedicated 240 VAC circuit with a 15 Amp receptacle.

**DO NOT CONNECT THE UNIT TO ANY TYPE OF VOLTAGE OTHER THAN THAT ON THE NAMEPLATE. DOING SO WILL DAMAGE THE UNIT AND VOID THE WARRANTY.**



## INITIAL START UP

Level unit using the adjustable feet under the unit (approximately 1/2" adjustment).

Before using the unit for the first time, wipe down the exterior and toasting area with a damp cloth. Take to a well ventilated area and heat for approximately 30 minutes. The grill may emit a small amount of smoke as the cooking surfaces reach 450°F (232°C). Do not be alarmed, as the smoke is caused by oils associated with the manufacturing process and will stop when the burn off is complete. Brush off any debris from the toasting surface.

## SEASONING THE COOKING SURFACES (NON CHROME SURFACES)

### FIRST TIME SEASONING

Follow your company/corporate guidelines for seasoning cooking surfaces. or

1. Bring the grill to 300°F (149°C) and leave it on while doing the next two steps.
2. Brush the cooking surfaces with a SALT-FREE release agent.  
If using an aerosol agent, first apply into a cup and then brush onto cooking surface.
3. Let sit for 20 minutes, and then wipe clean using a warm damp cloth.

### DAILY SEASONING

The grill should not require much seasoning while in use. In most cases, brush a light coating of a **SALT-FREE** baking release agent in the morning and occasionally throughout the day will be enough to prevent any sticking. It is not necessary to brush before grilling each item.

### PRESET TIME AND TEMPERATURE

If adjustments are required, please refer to the time or temperature programming section in this manual.

### °F/°C CONVERSION

To change the temperature display from °F to °C or from °C to °F, hold the TEMP button while the unit is turned off. While holding the TEMP button, turn the unit on. The display will be the changed temperature mode. To change back, repeat the procedure.

## OPERATING INSTRUCTIONS

1. Turn unit on by placing switch in "ON" position. The "Heat On" indicator, program number and display will flash indicating unit is heating. When the preset temperature is reached, the heating light, display and program light indicator will stop flashing followed by 3 beeps. (Initial startup heating time is approximately 30 minutes).
2. Place product on the bottom cooking surface of the unit and close the lids.
3. Press program button and let displayed time count down to "0" at which time unit will beep. To turn off the beeper, press program button again.
4. Raise lids until it engages into first indent and remove food. Using spatula, scrape residue into grease catcher tray.  
  
Note: Metal utensils with rounded corners may be used, however, using nonmetal utensils will prolong the life of the cooking surface.
5. Turn the unit off when not in use.

## TEMPERATURE/TIMER CONTROLLER OPERATION SPECIFICATIONS

### Startup:

1. The preset time will flash until preset temperature is reached.
2. When the control reaches preset temperature, time display, "Heat On" indicator and program indicator will stop flashing and the alarm will beep three times.

### Temperature:

1. To view the actual temperature, press and hold "Temp Button." Display will read "Lo F" if temperature is below 273°F (134°C) and "Hi F" if temperature is above 573°F (301°C).

### To Program Time and Temperature:

1. Press and hold "TEMP" (actual temperature displays).
2. While holding "TEMP," press and hold any program button on the Left one second, the LED above the program number light and the display reads "\_\_\_\_." Enter the four-digit security code sequence, 4, 3, 2, 1. The security code will not show on the display. Once the correct sequence has been entered, the preset time will be displayed and the LED for that program will begin to flash.
3. Set the time with the "+ or -" buttons.
4. Press the "TEMP" button to save the time.
5. The preset temperature will now be displayed.
6. Set the desired temperature for this program using the "+ or -" buttons.
7. Press the "TEMP" button to save temperature and to exit programming mode for this program. The LED will stop flashing but will remain lit.
8. Press any other program button within 15 seconds to continue programming without re-entering the security code.
9. While programming a program (LED is flashing), if no input is received for 15 seconds, the unit will revert to normal operation and the security code must be re-entered.

**Note: Temperature settings are done with the left side buttons** only. The time settings programmed on the Left buttons will also be programmed onto the **right side**. See below to make time changes to the **right side** only. **Each programming change must be saved by pressing the "TEMP" button!**

### Right Side (Timer only):

1. To Change the time on the right side, press and hold the "TEMP" button, and press and hold any program button on the right for one second. The LED above the program button will light and the Right Display will read "\_\_\_\_." Enter the four-digit security code sequence, 4, 3, 2, 1. The security code will not show on the display. Once the correct sequence has been entered, the preset time will be displayed and the LED for that program will begin to flash.
2. Set the time with the "+ or -" buttons.
3. Press the "TEMP" button to save the time.
4. The LED will stop flashing but will remain lit.
5. Press any other program button within 15 seconds to continue programming without re-entering the security code.
6. While programming a program (LED is flashing), if no input is received for 15 seconds, the unit will revert to normal operation and the security code must be re-entered.

### Operation:

1. Pressing any program button (1-4) will start the timer countdown and display the preset time remaining. The LED for the appropriate program will be lit during countdown and remain lit until another program is selected.
2. When the display reaches "00:00", the buzzer will sound and the digits will flash.
3. Press the program button to silence the buzzer and return the readout to programmed time.
4. The right and left sides will operate independently of each other. Both timers can be in operation at the same time. The "00:00" display will show which side is timed out.

### MONTHLY INSPECTION

Check all bolts/screws and tighten if necessary.

### CLEANING (NON-CHROME SURFACES)

Begin cleaning procedure by using the operating procedures within your organization, or follow the steps below:

1. If particles adhere to the cooking surface during the day, scrape them off with a spatula.

**NOTE:** It is best not to let food residue onto the grill, as food build-up on the grill will increase sticking and smoking. In addition, carbon may build up on the grill surface and reduce the cooking efficiency.

**CARBON BUILDUP:** *A black matter that forms on or near the cooking surface. Generally this is a combination of: releasing agents, oils, food particles etc. that has cooked itself to the surface. After a period of time without cleaning, this will reduce performance and material may start flaking off. When that happens, follow the "Carbon Cleaning" procedures.*

2. At the end of the day, wipe down all surfaces with a warm, damp cloth and mild detergent, then dry.

### CARBON CLEANING

When carbon build up occurs, use a carbon removal agent (safe for aluminum & chrome surfaces) according to the instructions provided with the cleaner. When this process is complete, you must re-season the grill according to your company/corporate guidelines, or the seasoning instructions in this manual.



**CAUTION**

**DO NOT IMMERSE OR LET THE UNIT STAND IN WATER. DO NOT HOSE DOWN THE UNIT. KEEP THE UNIT AWAY FROM RUNNING WATER.**

**DO NOT SPLASH THE CONTROL HOUSING! DO NOT SPLASH THE CONDUIT CONNECTING THE TOP AND BOTTOM OF THE GRILL!**



**WARNING**

**DO NOT USE ICE ON COOKING SURFACE!**

**BEFORE CLEANING ALL OTHER UNITS MAKE SURE POWER IS TURNED OFF AND UNIT IS UNPLUGGED.**

To remove burned on grease or food residue use the following mixture:

1 Tablespoon liquid dish detergent

1 Cup of warm water

While holding top lid with one hand, apply this mixture to cold or warm top cooking surface with a sponge or plastic scrubbing pad. Wipe with clean sponge or towel until it is clean.

Empty and clean grease catcher tray as required using detergent and water after removing tray from unit.

## CLEANING (CHROME SURFACES)

It takes very little time and effort to keep this Industrial Chromium griddle surface sparkling clean and performing at top efficiency. **DO NOT** allow grease to accumulate as it will carbonize and become difficult to remove. To prevent this condition the following cleaning suggestions should be followed:

1. Remove excess grease and food regularly with a 4" (100mm) wide Razor Sharp type scraper with rounded corners and wipe surface with a damp cloth if desired.
2. Following the scraping, for end of the day cleaning, a damp cloth and a non-silicated, non-abrasive, non-chlorinated cleaner such as Bon-Ami may be used to wipe surface clean, followed by wiping with a clean wet cloth.
3. Use a clean cloth and good non-abrasive cleaner to clean the (NON COOKING SURFACES) stainless steel body of the griddle. Wipe the control panel front with a soft cloth.
4. At least once a day, remove the waste drawer and wash in the same way as an ordinary cooking utensil. The drawer is removed by pulling forward and out.



**CAUTION**

1. **Never** use pumice, griddle stones, or abrasives on a chromium surface.
2. **Never** strike a chromium griddle surface with a sharp instrument or spatula edge.
3. **Never** use steel wool.
4. **Never** use commercial liquid grill cleaner on the griddle surface.
5. **Abusing** surface voids the warranty.



**CAUTION**

## CHROME SURFACE LIMITED WARRANTY EXCLUSIONS

Your Chrome Two Sided Grill has been designed to give you many years of cooking reliability and requires minimum maintenance to keep the chrome surface in its original condition. All Chrome surfaces are warranted for a period of 1 years against manufacturing defects to the original owner from the date of installation. This limited warranty is void if it is determined by Star Manufacturing International Incorporated or one of its authorized representatives that the chrome surface has been misused or abused or subjected to the following situations:

1. Improperly installed.
2. Incorrect voltage applied to electric Pro-Max units allowing the surface to overheat and discolor.
3. The misuse of any instrument or tool which scratches or makes indentations in the surface which could cause the surface to peel, flake, or chip off.
4. The use of any chemical or abrasive cleaning solution, griddle brick, stone, screen or other cleaning products which could damage and affect the performance of the chrome surface.
5. The neglect of daily routine maintenance to the chromium surface.

### THOROUGHLY INSPECT YOUR UNIT ON ARRIVAL

This unit has been tested for proper operation before leaving our plant to insure delivery of your unit in perfect condition. However, there are instances in which the unit may be damaged in transit. In the event you discover any type of damage to your product upon receipt, you must immediately contact the transportation company who delivered the item to you and initiate your claim with same. If this procedure is not followed, it may affect the warranty status of the unit.

### LIMITED EQUIPMENT WARRANTY

All workmanship and material in Star products have a one (1) year limited warranty on parts & labor in the United States and Canada. Such warranty is limited to the original purchaser only and shall be effective from the date the equipment is placed in service. Star's obligation under this warranty is limited to the repair of defects without charge, by the factory authorized service agency or one of its sub-agencies. Models that are considered portable (*see below*) should be taken to the closest Star service agency, transportation prepaid.

- > Star will not assume any responsibility for loss of revenue.
- > On all shipments outside the United States and Canada, see International Warranty.
- \* The warranty period for the Ultra-Max, Hot Plates, Griddles, Charbroilers is (3) years parts & labor.
- \* The warranty period for the Star-Max, Charbroilers, Griddles, Hot Plates, Fryers & Finishing Oven is (2) years parts & labor.
- \* The warranty period for the JetStar six (6) ounce & Super JetStar eight (8) ounce series popcorn machines is two (2) years.
- \* The warranty period for the Chrome-Max Griddles is five (5) years on the griddle surface. See detailed warranty provided with unit.
- \* The warranty period for Teflon/Dura-Tec coatings is one year under normal use and reasonable care. This warranty does not apply if damage occurs to Teflon/Dura-Tec coatings from improper cleaning, maintenance, use of metallic utensils, or abrasive cleaners, abrasive pads, product identifiers and point-of-sale attachments, or any other non-food object that comes in continuous contact with the roller coating. This warranty does not apply to the "non-stick" properties of such materials.
- > This warranty does not apply to "Special Products" but to regular catalog items only. Star's warranty on "Special Products" is six (6) months on parts and ninety (90) days on labor.
- > This warranty does not apply to any item that is disassembled or tampered with for any purpose other than repair by a Star Authorized Service Center or the Service Center's sub-agency.
- > This warranty does not apply if damage occurs from improper installation, misuse, wrong voltage, wrong gas or operated contrary to the Installation and Operating instructions.
- > This warranty is not valid on Conveyor Ovens *unless* a "start-up/check-out" has been performed by a Factory Authorized Technician.

### PARTS WARRANTY

Parts that are sold to repair out of warranty equipment are warranted for ninety (90) days. The part only is warranted, the labor to replace the part is **NOT** warranted.

### SERVICES NOT COVERED BY WARRANTY

1. Travel time and mileage rendered beyond the 50 mile radius limit
2. Mileage and travel time on portable equipment (*see below*)
3. Labor to replace such items that can be replaced easily during a daily cleaning routine, i.e; removable kettles on fryers, knobs, grease drawers on griddles, etc.
4. Installation of equipment
5. Damages due to improper installation
6. Damages from abuse or misuse
7. Operated contrary to the Operating and Installation Instructions
8. Cleaning of equipment
9. Seasoning of griddle plates
10. Voltage conversions
11. Gas conversions
12. Pilot light adjustment
13. Miscellaneous adjustments
14. Thermostat calibration and by-pass adjustment
15. Resetting of circuit breakers or safety controls or reset buttons
16. Replacement of bulbs
17. Replacement of fuses
18. Repair of damage created during transit, delivery, & installation OR created by acts of God

### PORTABLE EQUIPMENT

Star will not honor service bills that include travel time and mileage charges for servicing any products considered "Portable" including items listed below. These products should be taken to the Service Agency for repair:

- \* The Model 510FD, 510FF Fryer.
- \* The Model 526TOA Toaster Oven.
- \* The Model J4R, 4 oz. Popcorn Machine.
- \* The Model 518CMA & 526CMA Cheese Melter.
- \* The Model 12MC & 15MC & 18MCP Hot Food Merchandisers.
- \* The Model 12NCPW & 15NCPW Nacho Chip/Popcorn Warmer.
- \* All Hot Dog Equipment **except Roller Grills & Drawer Bun Warmers.**
- \* All Nacho Cheese Warmers **except Model 11WLA Series Nacho Cheese Warmer.**
- \* All Condiment Dispensers **except the Model HPD & SPD Series Dispenser.**
- \* All Specialty Food Warmers **except Model 130R, 11RW Series, and 11WSA Series.**
- \* All QCS/RCS Series Toasters **except Model QCS3 & RCS3 Series.**
- \* All Fast Steamer Models **except Direct Connect Series.**

### ALL:

- \* Pop-Up Toasters
- \* Butter Dispensers
- \* Pretzel Merchandisers  
(Model 16PD-A Only)
- \* Pastry Display Cabinets
- \* Nacho Chip Merchandisers
- \* Accessories of any kind
- \* Sneeze Guards
- \* Pizza Ovens  
(Model PO12 Only)
- \* Heat Lamps
- \* Pumps-Manual

The foregoing warranty is in lieu of any and all other warranties expressed or implied and constitutes the entire warranty.

### FOR ASSISTANCE

Should you need any assistance regarding the Operation or Maintenance of any Star equipment; write, phone, fax or email our Service Department. In all correspondence mention the Model number and the Serial number of your unit, and the voltage or type of gas you are using.

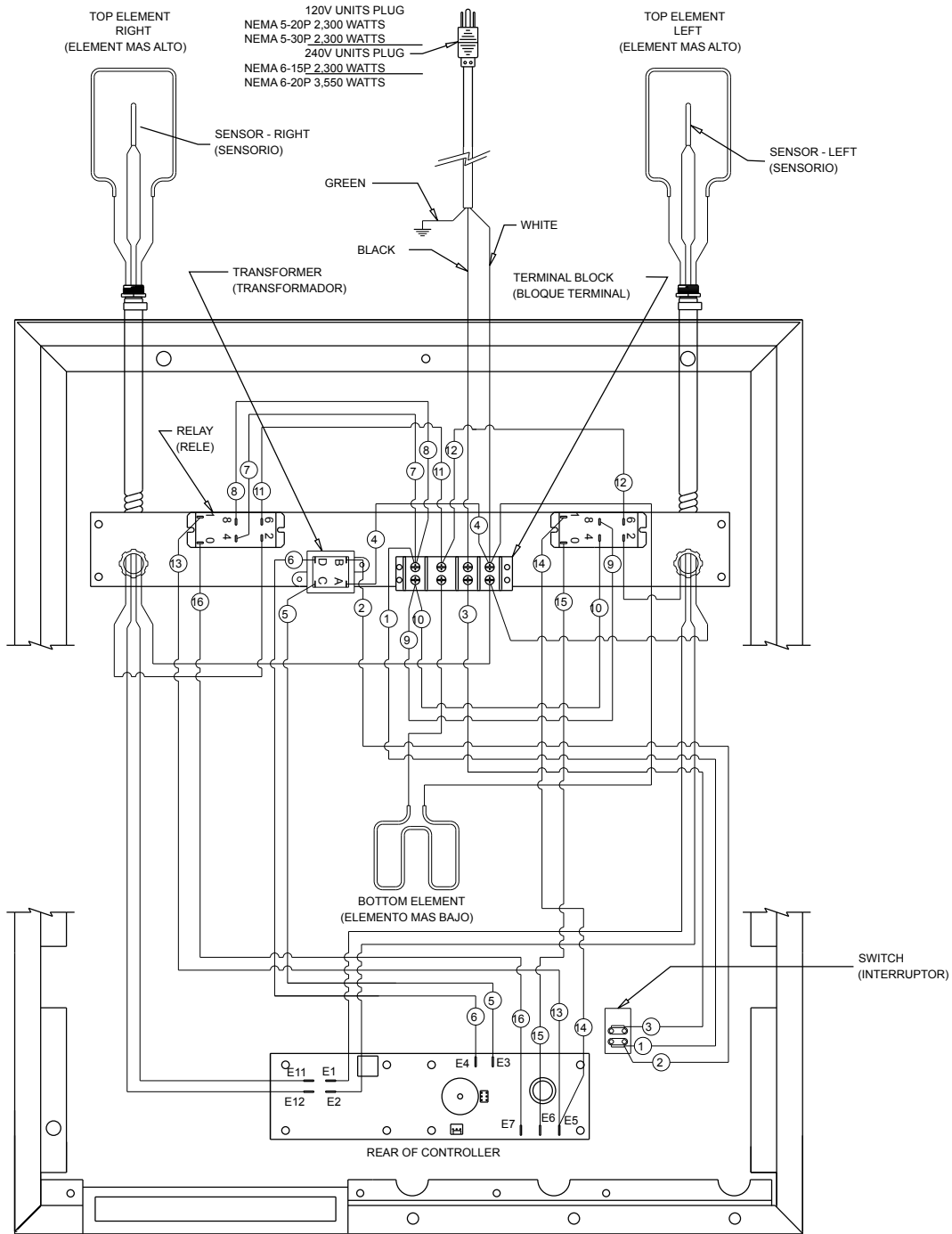

**FOR REFERENCE**  
 WIRING DIAGRAM IS SHOWN AS UNIT IS ASSEMBLED  
 WITH THE BOTTOM PLATE REMOVED. THE TOP  
 DESCRIPTIONS ARE THEIR POSITIONS WHEN UPRIGHT.

SOME ITEMS ARE INCLUDED FOR  
 ILLUSTRATIVE PURPOSES ONLY AND IN  
 CERTAIN INSTANCES MAY NOT BE AVAILABLE

- MODEL CG14SPT-120V
- CG14SPT-240V
- CG14SPTI-240V
- GR14SPTA-120V
- GR14SPTA-240V
- GR14SPTK-120C
- GR14SPTI-240V

**WIRE DIAGRAM**  
 120V/240V, 2300 WATT  
 (2J-26323 CONTROLLER ONLY)



**STAR MANUFACTURING INTERNATIONAL, INC.**  
 SK2078 REV. B 6/30/11

# UNITS WITH IEC CONNECTOR:

## POWER INLET CONNECTOR:

IEC 320 C-20 POWER INLET, ON ALL 208 - 240V UNITS.  
FOR USE WITH DETACHABLE CORDSETS SUPPLIED  
WITH A STRAIGHT, FEMALE, IEC 60320 C-19 CONNECTOR.

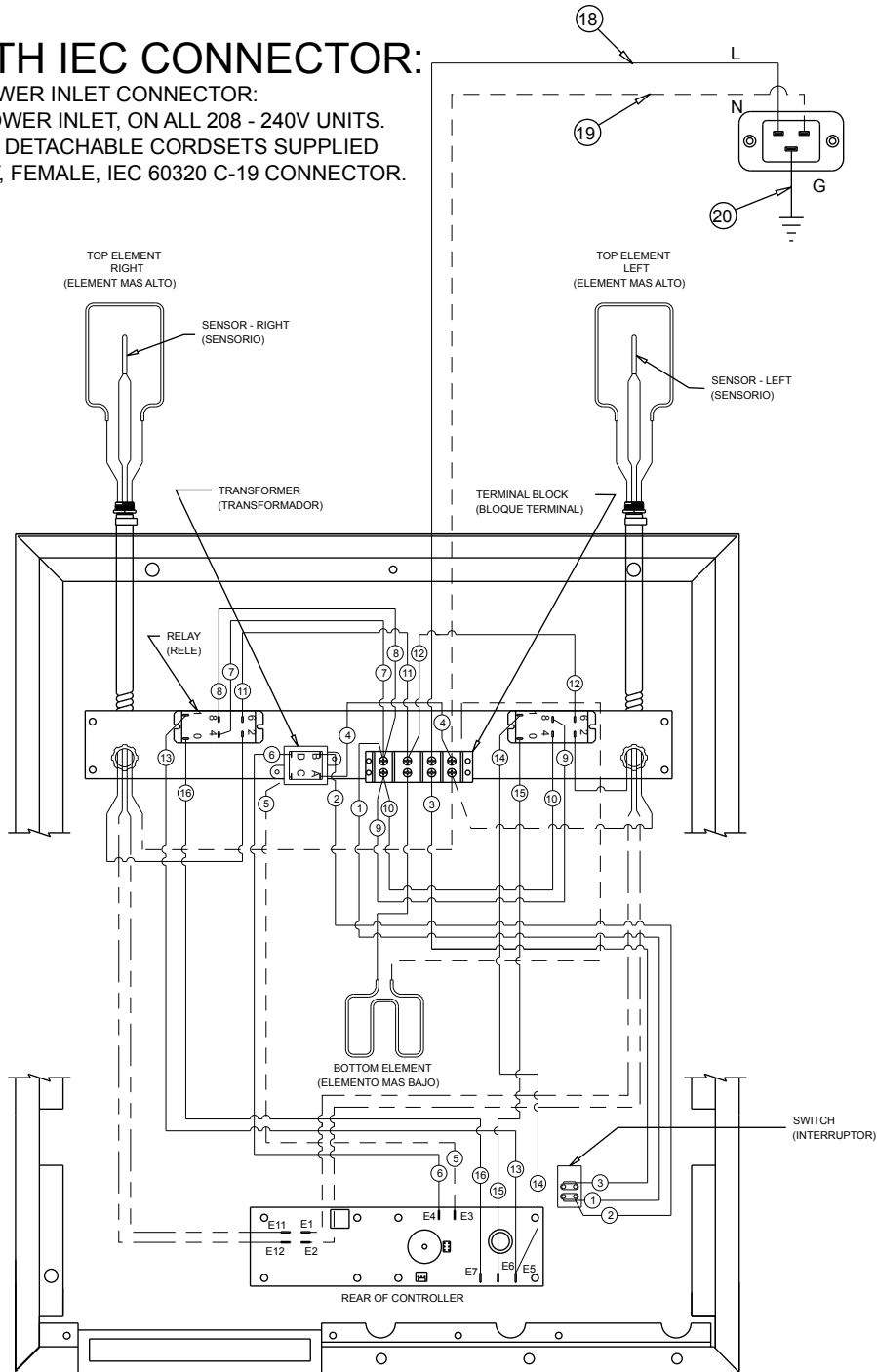

FOR REFERENCE  
WIRING DIAGRAM IS SHOWN AS UNIT IS ASSEMBLED  
WITH THE BOTTOM PLATE REMOVED. THE TOP  
DESCRIPTIONS ARE THEIR POSITIONS WHEN UPRIGHT.

## WIRE DIAGRAM, 230V, 2300 WATT (2J-Z6323 CONTROLLER ONLY)



**MODEL: GR14SPTA-UK**

THIS DRAWING CONTAINS INFORMATION CONFIDENTIAL TO STAR MFG. INT'L. INC.  
NO REPRODUCTION OR DISCLOSURE OF ITS CONTENTS IS PERMITTED.

**STAR MANUFACTURING INTERNATIONAL INC.**  
SK2017

Rev C

06/30/2011

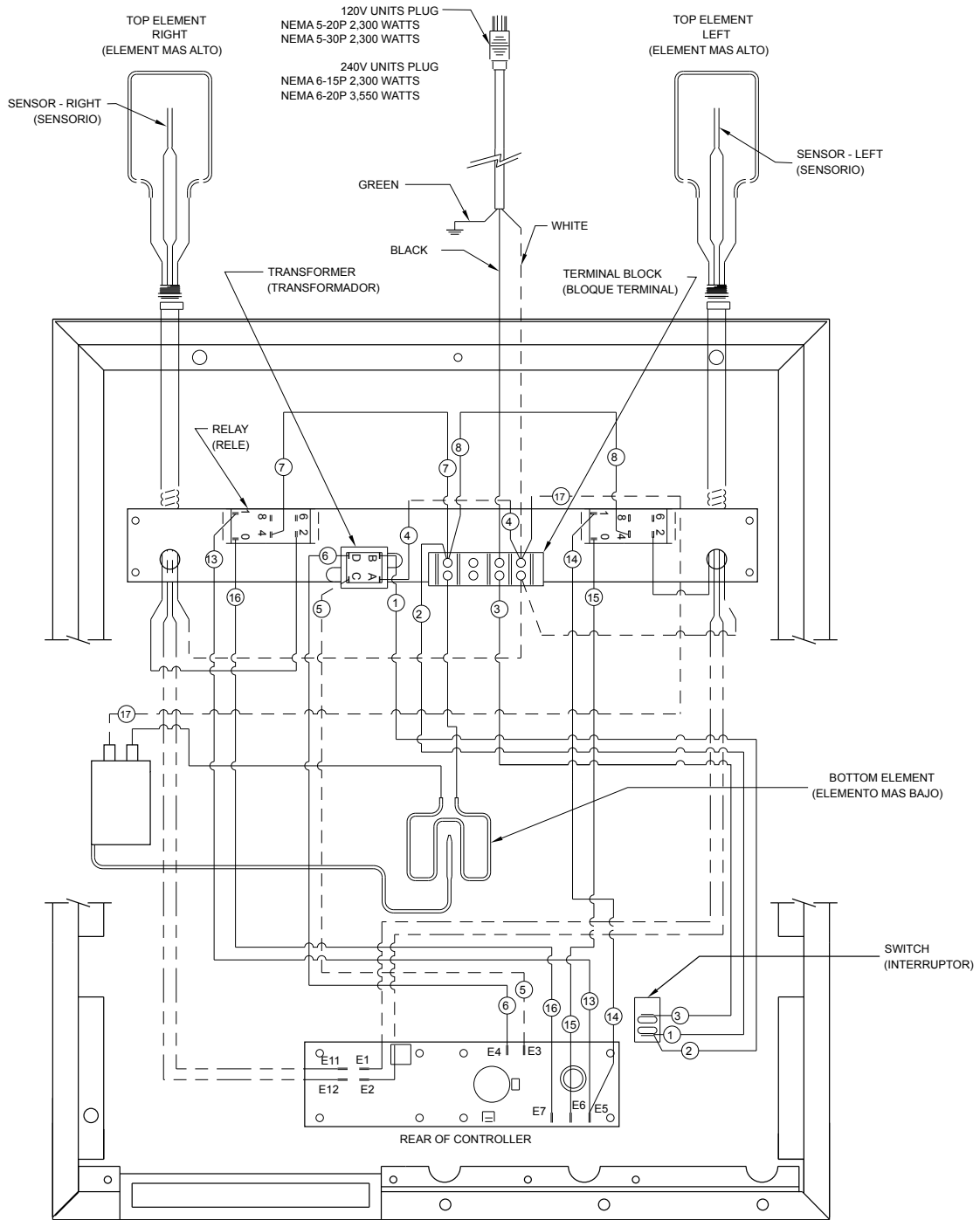

**FOR REFERENCE**  
**WIRING DIAGRAM IS SHOWN AS UNIT IS ASSEMBLED**  
**WITH THE BOTTOM PLATE REMOVED. THE TOP**  
**DESCRIPTIONS ARE THEIR POSITIONS WHEN UPRIGHT.**

**WIRE DIAGRAM**

SOME ITEMS ARE INCLUDED FOR  
 ILLUSTRATIVE PURPOSES ONLY AND IN  
 CERTAIN INSTANCES MAY NOT BE AVAILABLE

**MODEL: GR14SPTIP240**



**STAR MANUFACTURING INTERNATIONAL, INC.**

SK2336

REV. A

6/30/11

**120V UNIT PLUGS**  
 NEMA 5-20P 2,300 WATTS  
 NEMA 5-30P 2,300 WATTS

**208V UNIT PLUGS**  
 NEMA 6-15P 3,100 WATTS  
 NEMA 6-20P 3,100 WATTS

**240V UNIT PLUGS**  
 NEMA 6-15P 2,300 WATTS  
 NEMA 6-20P 3,550 WATTS

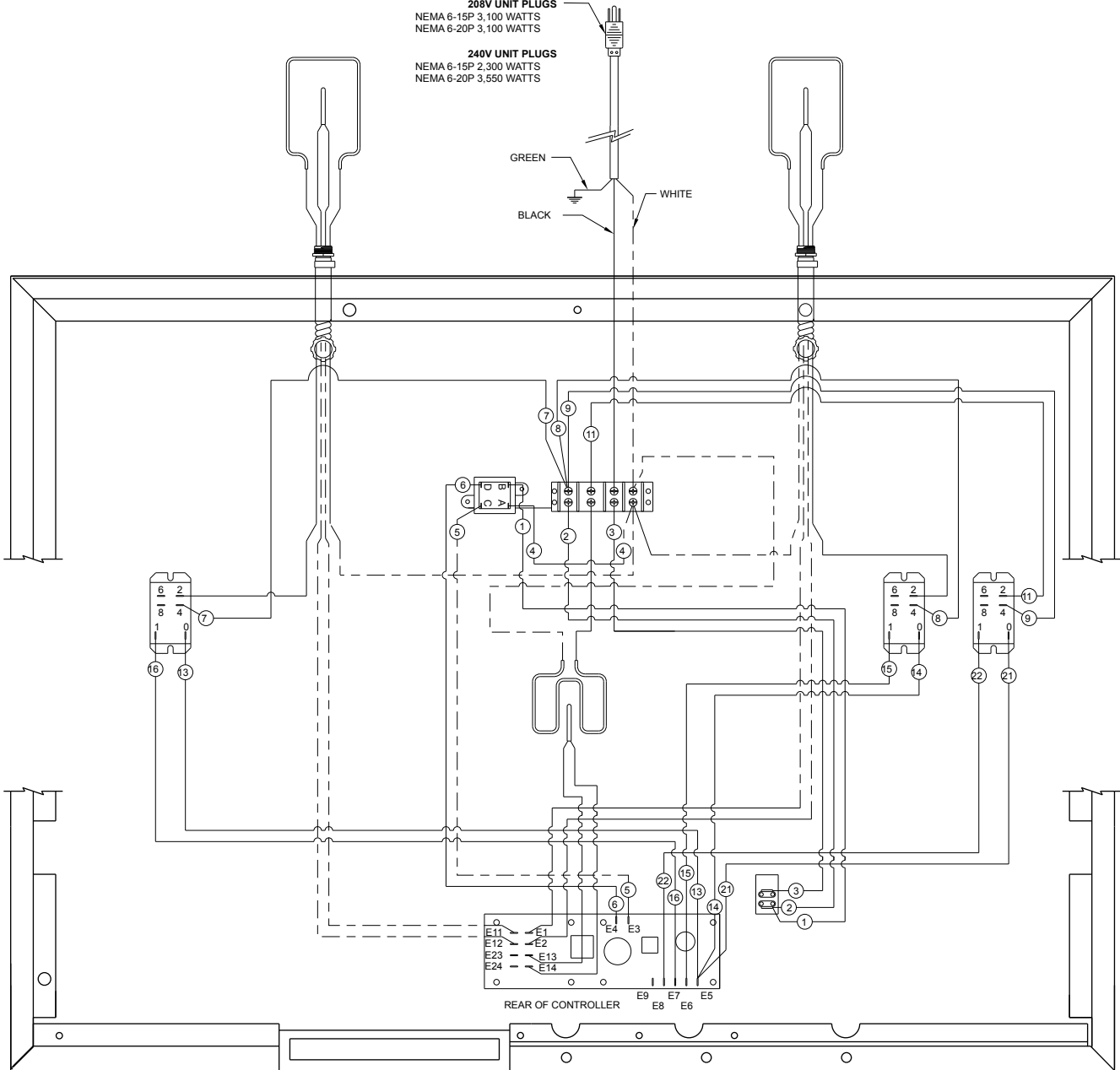

FOR REFERENCE  
 WIRING DIAGRAM IS SHOWN AS UNIT IS ASSEMBLED  
 WITH THE BOTTOM PLATE REMOVED. THE TOP  
 DESCRIPTIONS ARE THEIR POSITIONS WHEN UPRIGHT.

**WIRE DIAGRAM  
 SG WITH 3 PROBES**

SOME ITEMS ARE INCLUDED FOR  
 ILLUSTRATIVE PURPOSES ONLY AND IN  
 CERTAIN INSTANCES MAY NOT BE AVAILABLE



**MODEL GR14STECB**

**STAR MANUFACTURING INTERNATIONAL, INC.**

SK2517

REV. -

5/31/11

2M-Z5818, Split-Top Two Sided Grill

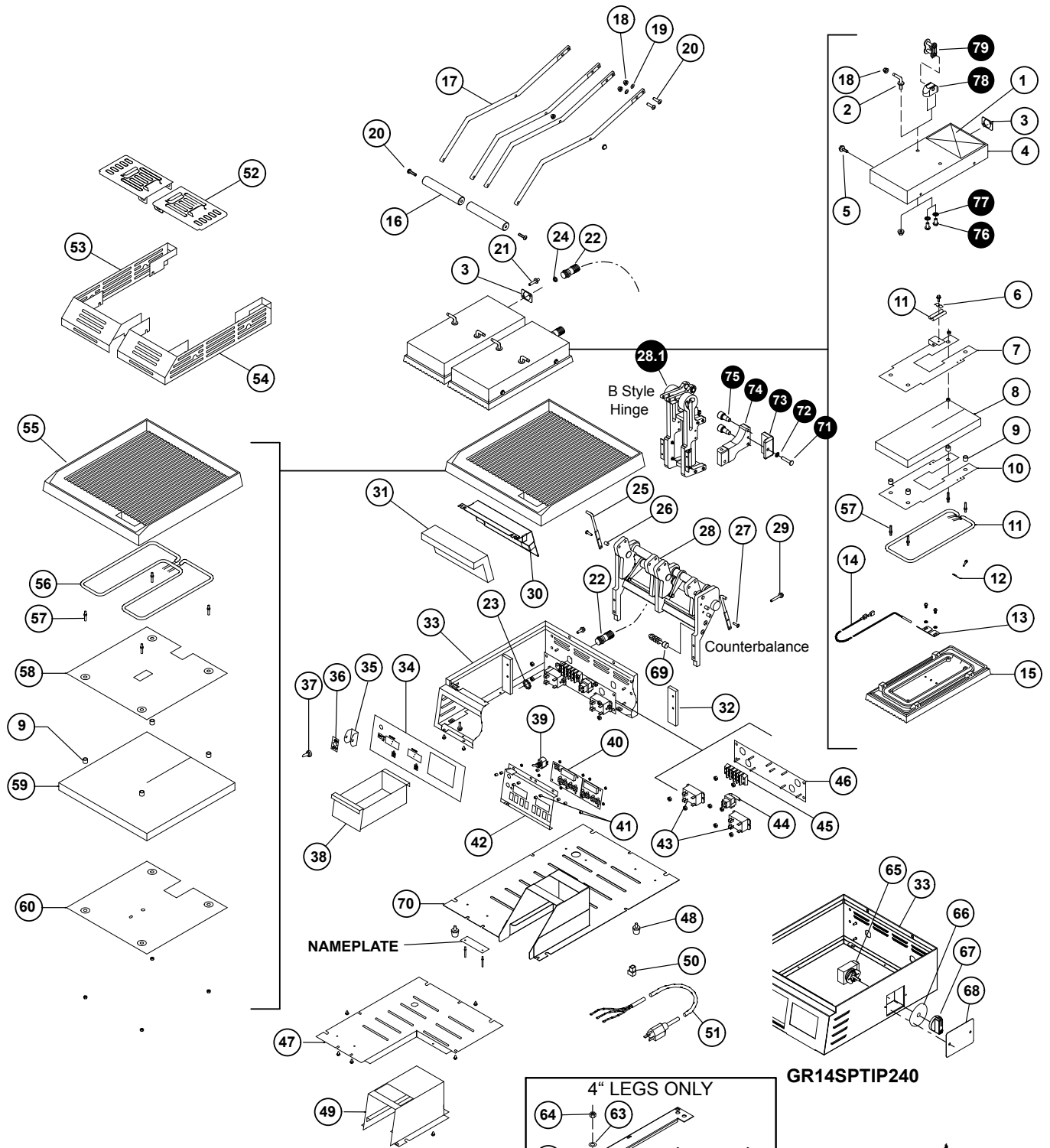

SOME ITEMS ARE INCLUDED FOR ILLUSTRATIVE PURPOSES ONLY AND IN CERTAIN INSTANCES MAY NOT BE AVAILABLE

This drawing contains information confidential to Star Manufacturing International, Inc. No reproduction or disclosure of its contents is permitted.

● = B Style Hinge Units Only

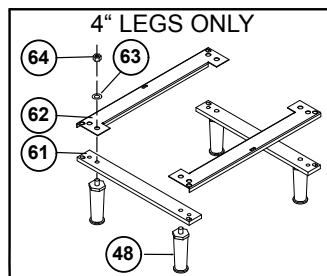

GR14SPTIP240



MODEL CG/GR14SPT

STAR MANUFACTURING INTERNATIONAL, INC.  
SK1901 REV. H 9/14/2011

# PARTS LIST

January 16, 2013, Rev N

CG14SPT, CG14SPTIG-120V, 120C, 230V & 240V, CG/GR14STE  
 GR14SPTA, GR14SPTC, GR14SPTK-120V, 120C, 230V & 240V  
 CG/GR14SPTI-240V, GR14SPTIP240 Split Lid Table Top Grill

MODEL \_\_\_\_\_

Item No	Part No	Qty	Description	Application
1	<a href="#">2M-Z2620</a>	2	LABEL CAUTION, BI-LINGUAL	
2	<a href="#">2C-Z3200</a>	4	PIN - TOP HOUSING	
3	<a href="#">2A-Z3827</a>	2	PLATE, STAMPING CONDUIT	
4	<a href="#">D9-GR0181</a>	2	TOP HOUSING & CONDUIT ASSEMBLY	
	<a href="#">D9-Z11716</a>	1	TOP HOUSING, LT SPLT	CG14STKE-120, GR14STB, GR14STE, GR14STKE120C
	<a href="#">D9-Z11717</a>		TOP HOUSING, RT SPLT	
5	<a href="#">2C-Z5883</a>	8	10-24 X 1/2" FZA SCREW, TOP HOUSING	
6	<a href="#">B9-04-WB-0046</a>	2	CLAMP WIRE SUPPORT	
7	<a href="#">D9-GR0182</a>	2	TOP RETAINING PLATE ASSEMBLY	
8	<a href="#">D9-Z2133</a>	2	INSULATION FIBERGLASS TOP	
9	<a href="#">2A-Z6604</a>	12	SPACER - INSULATION PLATE	SPTC, SPTI
	<a href="#">2A-Z9514</a>			
10	<a href="#">D9-Z3902</a>	2	PLATE - TOP ELEMENT RETAINING	SPTC, SPTI
	<a href="#">D9-Z9513</a>			
11	<a href="#">PS-Z9325</a>	2	ELEMENT, HEATING, TOP 500W	120V
	<a href="#">PS-Z9326</a>		ELEMENT, HEATING, TOP 500W 230/240V	SPT, SPTA, SPTC, SPTA, SPTG 230/240V
	<a href="#">PS-Z9521</a>		ELEMENT, HEATING, TOP 700W	SPTI
	<a href="#">2N-Z13966</a>		ELEMENT, 400W 120V SPT	CG14STE120CL
	<a href="#">2N-Z11709</a>		ELEMENT, 650 WATT, 120V	CG14STKE, GR14STE, GR14STKE
	<a href="#">2N-Z14893</a>		ELEMENT, 650W, 208V TOP STE	GR14STECB208
12	<a href="#">2C-Z3350</a>	2	HALF CLAMP - .188 DIAMETER	
13	<a href="#">D9-Z3903</a>	2	BRACKET, PROBE MOUNT	
14	<a href="#">2E-Z3278</a>	2	RTD PROBE - 48" LONG WIRE - THERMISTOR	
15	<a href="#">PS-GR0356</a>	2	KIT, <a href="#">2F-Z3237</a> CASTING REPLACEMENT	SMOOTH - ALUM
	<a href="#">PS-GR0355</a>		KIT, 2F-Z5615 CASTING REPLACEMENT	GROOVED - ALUM
	<a href="#">PS-GR0504</a>		KIT, 2F-Z5615-1 COATED CASTING REP.	GROOVED - ALUM
	<a href="#">2F-Z9651</a>		CASTING - TOP SMOOTH, CHROME	
	<a href="#">2F-Z8349</a>	2	CASTING - TOP SMOOTH, IRON	CG14SPTIS240
		1		
<a href="#">2F-Z7967</a>	2	CASTING - TOP GROOVE, IRON	CG14SPTIS240	
	1			
16	<a href="#">2V-Z3152</a>	2	HANDLE	
17	<a href="#">2B-Z3336</a>	4	14" CG14SPT ARM	
	<a href="#">2B-Z9515</a>		ARM	SPTC, SPTI
	<a href="#">2B-Z10355</a>		ARM	CG14SPTK-120/240V, GR14SPTKM-UK
	<a href="#">2B-Z12554</a>	2	ARM, LEFT ST	CG14STKE-120, GR14STB, GR14STE, GR14STKE120C
	<a href="#">2B-Z12555</a>		ARM, RIGHT ST	CG14STKE-120, GR14STB, GR14STE, GR14STKE120C
18	2C-40637	12	ACORN NUT, 1/4-20 CAP MS	
19	<a href="#">2C-08-07-0262</a>	8	WASHER 1/4 INT STL NP	
20	<a href="#">2C-Z2992</a>	12	BOLT 1/4-20X1 PHP STL NP	Used w/Fig. No 28
	<a href="#">2C-1523</a>	4	.250-20UNC X 0.75 LG RHP SCREW	Used w/Fig. No 28.1
	<a href="#">2C-08-07-0262</a>		.250 INTERNAL TOOTH LOCK WASHER	
			ADD LOCKTITE 242 TO THREADS	
21	<a href="#">2C-Z3917</a>	4	RIVET, POP,	
22	<a href="#">2E-Z2898</a>	2	CONDUIT ASSEMBLY	

2M-Z5818, Split-Top Two Sided Grill

**IMPORTANT: WHEN ORDERING, SPECIFY VOLTAGE OR TYPE GAS DESIRED  
 INCLUDE MODEL AND SERIAL NUMBER**

PAGE 1  
 OF 4

Some items are included for illustrative purposes only and in certain instances may not be available.



**Star International Holdings, Inc.**

# PARTS LIST

January 16, 2013, Rev N

CG14SPT, CG14SPTIG-120V, 120C, 230V & 240V

GR14SPTA, GR14SPTC, GR14SPTK-120V, 120C, 230V & 240V

MODEL CG/GR14SPTI-240V, GR14SPTIP240 Split Lid Table Top Grill

Item No	Part No	Qty	Description	Application
23	<a href="#">2E-Z3768</a>	2	LOCKNUT, CONDUIT 1/2"	
24	<a href="#">2C-Z3780</a>	4	RETAINER, CONDUIT	
25	<a href="#">2V-Z3252</a>	2	TOP HOUSING LATCH ROD	
26	<a href="#">2A-Y6142</a>	4	SLEEVE HANDLE	
27	<a href="#">2C-1516</a>	4	SCREW 10-24 X 1" STL RH NP, LATCH ROD	
28	<a href="#">2R-Z3345</a>	1	COUNTER BALANCE - SPLIT TOP	
28.1	<a href="#">PS-GR0536</a>	2	KIT, HINGE & SPRING, 14SPLT	CG14STE, CG14STKE, GR14STB, GR14STE,GR14STKE120C
29	<a href="#">2C-Z2593</a>	4	SCREW - 10-24X1 1/2 SL HX/W NP	
30	<a href="#">D9-Z11677</a>	1	INSULATION BAFFLE ASSEMBLY	
31	<a href="#">D9-Z3826</a>	1	INSULATION - BAFFLE	
32	<a href="#">2A-Z6484</a>	2	PLATE (COUNTER BALANCE MOUNT)	
33	<a href="#">D9-GR0152</a>	1	BODY ASSEMBLY	CG14SPTK-120/240V
	<a href="#">D9-GR0393</a>			GR14SPTIP
	<a href="#">D9-GR0394</a>		BODY ASSY - 14" CG/CG14	GR14STE
	<a href="#">D9-GR0507</a>		BODY ASSY 14" SPT	GR14STB
	<a href="#">D9-GR0461</a>			
34	<a href="#">2M-Z5817</a>	1	OVERLAY-STANDARD	CG14SPT, CG14SPTI, CG14STE, GR14SPTA, GR14SPTC, GR14SPTI, GR14SPB,. GR14STE, GR14SPTT
	<a href="#">2M-Z3337</a>		OVERLAY	GR14SPT-120/240V & CUL
	<a href="#">2M-Z10851</a>			CG14SPTK-120/240V
	<a href="#">2M-Z11984</a>			GR14STE-120
	<a href="#">2M-Z11983</a>			GR14STE-120V
	<a href="#">2M-Z10087</a>			GR14STKE120C, GR14SPTK-120, GR14SPTKM
35	<a href="#">Z1-70-07-0343</a>	1	SWITCH GUARD	
36	<a href="#">2M-Z18461</a>	1	LABEL ON & OFF	
37	<a href="#">2I-05-07-0013</a>	1	BOOT SWITCH	
38	<a href="#">D9-GR0518</a>	1	GREASE DRAWER ASSY: FLAT FRONT	CG14SPTK, CG14STE
	<a href="#">D9-GR0517</a>		GREASE DRAWER ASSY: SLOPED FRONT	GR14SPTKG120, GR14STKE, GR14SPTKM
39	<a href="#">2E-Z3808</a>	1	SWITCH TOGGLE	
40	<a href="#">2J-Z3263</a>	1	TIME/TEMP CONTROL+HRDW (Taco Bell Only)	GR14SPT-120/240/CUL, GR14STB-120/240V, CG14SPT-120/230/240V, GR14SPT-CE
	<a href="#">2J-Z6323</a>		CONTROLLER, TIME/TEMP (C - F)	CG14SPT, CG14SPTI, CG14STE, GR14SPTA, GR14SPTC, GR14SPTI, GR14STE, GR14SPT120/240V/ CUL
	<a href="#">2J-Z13327</a>		TIME/TEMP CONTROL F/C	GR14STECB208
	<a href="#">D9-GR0387</a>		CONTROL PROGRAMMING	CG14SPTK-120/120C/240V
	<a href="#">D9-GR0483</a>		CONTROL PROGRAMMING	GR14SPTIP240
	<a href="#">D9-GR0380</a>		CONTROL PROGRAMMING	GR14SPTK-120/120C/240, GR14SPTKG120/240, GR14SPTKM120/240, GR14STKE120C
	<a href="#">D9-GR0539</a>		CONTROL PROGRAMMING	GR14SPTKM-UK
	<a href="#">D9-GR0533</a>		TIME/TEMP CONTROL F/C	GR14SPTT120V
	<a href="#">D9-GR0653</a>		CTRL PGM, PITA PIT	GR14STEPP
	<a href="#">DR-GR0664</a>		CNTRL PROG., TACO BELL	GR14STE-120V

2M-Z5818, Split-Top Two Sided Grill

**IMPORTANT: WHEN ORDERING, SPECIFY VOLTAGE OR TYPE GAS DESIRED**

**INCLUDE MODEL AND SERIAL NUMBER**

PAGE 2  
OF 4

Some items are included for illustrative purposes only and in certain instances may not be available.



**Star International Holdings, Inc.**

# PARTS LIST

January 16, 2013, Rev N

CG14SPT, CG14SPTIG-120V, 120C, 230V & 240V  
 GR14SPTA, GR14SPTC, GR14SPTK-120V, 120C, 230V & 240V

MODEL CG/GR14SPTI-240V, GR14SPTIP240 Split Lid Table Top Grill

Item No	Part No	Qty	Description	Application
41	2K-Z1971	14	SPACER	
42	D9-GR0151	1	FACEPLATE ASSEMBLY	
	D9-GR0382		FACEPLATE ASSEMBLY	CG14SPTK
43	2E-Z3335	2	RELAY DOUBLE POLE-SINGLE THROW	
		3		GR14STECB208
44	2E-05-07-0350	1	TRANSFORMER 230V/10V 6VA	230V
	2E-05-07-0351		TRANSFORMER 115/10V 6VA	
45	2E-Z2894	1	TERMINAL BLOCK (304)	
46	D9-GR0156	1	REAR PLATE ASSEMBLY	
47	D9-Z3259	1	BASE BOTTOM	CG14SPTID240, GR14SPTA-CE
	D9-Z10086			
48	2A-Z12980	4	2.5" FOOT BASE	SPTC, SPTI, SPTIP
	2A-Z11500		4" NON SKID FOOT BASE	SPTC, SPTI
	2A-Z11501		FOOT 1" SOLID RUBBER	CG14SPTK, GR14SPTG
49	D9-GR0150	1	GREASE CABINET ASSEMBLY	CG14SPTID240
	D9-GR0034			GR14SPTA-CE
50	2K-Y6764	1	BUSHING - STRAIN RELIEF	
51	2E-Z4119	1	CORD POWER	120V
	D9-GR0193		CORD POWER	120C
	D9-GR0194		CORD POWER	240V
	2E-Y9251		CORD SET CONT EUR 16AMP	CG14SPT-230V between 1-15-01 thru 8-16-04
	2E-Z2905		CORD POWER	SPTI- 240V
	2E-Z9192		CORDSET (DETACHABLE) - UK	GR14SPTKM-UK
52	D9-GR0189	2	TOP BURN GUARD ASSEMBLY	
53	D9-GR0177	1	BURN GUARD ASSEMBLY - LEFT	
	D9-GR0501		BURN GUARD, LT WELD ASSY	CG14STKE-120, GR14STB, GR14STE, GR14STKE120C
	D9-GR0335			CG14SPTI-230
54	D9-GR0176	1	BURN GUARD ASSEMBLY - RIGHT	
	D9-GR0500		BURN GUARD, RT WELD ASSY	CG14STKE-120, GR14STB, GR14STE, GR14STKE120C
	D9-GR0334			CG14SPTI-230
55	PS-GR0361	1	KIT, 2F-Z1945, CASTING SM REPLACEMENT	GR SERIES (NON-SPTI)
	PS-GR0362		KIT, 2F-Z1947, CASTING GR REPLACEMENT	CG SERIES (NON-SPTI)
	PS-GR0503		KIT, 2F-Z1947, COATED CASTING GR REPL	CG SERIES (NON-SPTI)
	2F-Z9653		CASTING - SMOOTH BOTTOM, CHROME	SPTC
	PS-GR0363		KIT, 2F-Z1949, CSTNG - BOTTOM, IRON	GR14SPTI
	PS-GR0364		KIT, 2F-Z1951, CSTNG - GROOVE, IRON	CG14SPTI
56	2N-Z9324	1	ELEMENT, HEATING, BTM	120V
	2N-Z9327		ELEMENT, HEATING, BTM 1300 W	230V-240V (NON-SPTI)
	2N-Z9520		ELEMENT, HEATING, BTM 2150 W	SPTI 230/240V
	2N-Z13967		ELEMENT, 1100W, 120V-14B	CG14STE120CL
	2N-Z14894		ELEMENT, 1800W, 208V BTM	GR14STECB208
57	2C-08-07-0285	12	SCREW 10-24 x 3/4 x 3/8	

2M-Z5818, Split-Top Two Sided Grill

**IMPORTANT: WHEN ORDERING, SPECIFY VOLTAGE OR TYPE GAS DESIRED  
 INCLUDE MODEL AND SERIAL NUMBER**

PAGE 3  
 OF 4

Some items are included for illustrative purposes only and in certain instances may not be available.



**Star International Holdings, Inc.**

# PARTS LIST

January 16, 2013, Rev N

CG14SPT, CG14SPTIG-120V, 120C, 230V & 240V  
 GR14SPTA, GR14SPTC, GR14SPTK-120V, 120C, 230V & 240V

MODEL CG/GR14SPTI-240V, GR14SPTIP240 Split Lid Table Top Grill

Item No	Part No	Qty	Description	Application
58	D9-Z13338	1	BOTTOM ELEMENT RETAINING PLATE	
	D9-Z9701		BOTTOM ELEMENT RETAINING PLATE	SPTC
59	D9-Z2888	1	INSULATION - 14"	
60	D9-Z13338	1	BOTTOM INSULATION RETAINING PLATE	
61	2V-Z3027	2	CROSS SUPPORT	SPTC, SPTI
62	D9-Z9516	2	SUPPORT BRACKET, LEGS	SPTC, SPTI
63	2C-08-07-0262	4	WASHER 1/4 INT STL NP	SPTC, SPTI
64	2C-Z2992	4	BOLT 1/4-20X1 PHP STL NP	SPTC, SPTI
65	2T-6447	1	THERMOSTAT 118V-236V	SPTIP
66	2M-Z11301	1	LABEL - DIAL	SPTIP
67	2R-Z4621	1	KNOB, 1-3/4 - .250"D"HOLE	SPTIP
68	D9-Z11304	1	PLATE, COVER	SPTIP
69	PS-GR134	AR	KIT, BEARING ASSY, COUNTER BALANCE	
70	D9-GR0520	1	BASE ASSY / GREASE CABINET	CG14SPT, CG14SPTI, CG14SPTIG, GR14SPTA, GR14SPTC, GR14SPTI, GR14SPTIP, GR14STB, GR14SPTE
	D9-GR0522			CG14SPTK, CG14STKE, GR14SPTK, GR14SPTKM120, GR14STKE
71	2C-1516	4	#10-24 UNC X 1.00 LG RHP SCREW	CG14STE, CG14STKE, GR14STB, GR14STE, GR14STKE120C
72	2C-6260	4	#10 INTERNAL TOOTH LOCK WASHER	
73	2A-Z12620	4	SPACER BLOCK	
74	2F-Z11943	2	BRACKET LT, ROLLER MOUNT	ALL B VERSION SPLIT TOP
	2F-Z11944		BRACKET RT, ROLLER MOUNT	
75	2C-Z13975	8	CAM FOLLOWER ASSY, B VERS HNG	ALL B VERSION HNG
76	2C-1512	8	SCREW 10-24X3/8 RHP STL NP	B SERIES UNITS
77	2C-6260	8	WASHER #10 INT STL NP	B SERIES UNITS
78	2V-Z11388	4	LINK ASSY BASE, TOP HOUSING	B SERIES UNITS
79	2A-Z11676	4	CHAIN LINK, 50SS	B SERIES UNITS
NI	D9-Z11977	1	PLATE, BASE CONDUIT	CG142TB, CG14B, CG14E, CG14IB, CG14IGTB, CG14ITB, CG14ITGTB, CG14ITLB, CG14ITSC, CG14TB, GR14B, GR14E, GR14E, GR14IB, GR14ITB, GR14SNB, GR14TB, CG14STKE, GR14STB, GR14STE, GR14STKE
NI	2E--Y9253	1	INLET IEC 320 16 AMP	CG14SPTI-230

2M-Z5818, Split-Top Two Sided Grill

**IMPORTANT: WHEN ORDERING, SPECIFY VOLTAGE OR TYPE GAS DESIRED  
 INCLUDE MODEL AND SERIAL NUMBER**

PAGE 4  
 OF 4

Some items are included for illustrative purposes only and in certain instances may not be available.



**Star International Holdings, Inc.**