



IMPORTANT FOR FUTURE REFERENCE
 Please complete this information and retain this manual for the life of the equipment:

Model #: _____
 Serial #: _____
 Date Purchased: _____

PLATINUM PRO SERIES PROBE OPERATION MANUAL



Model PCE15B/S-PRO



Model PCE15B/T-PRO

⚠ WARNING

Improper installation, adjustment, alteration, service or maintenance can cause property damage, injury or death. Read the installation, operating and maintenance instructions thoroughly before installing or servicing this equipment.

SOUTHBEND
 MIDDLEBY A Middleby Company
 1100 Old Honeycutt Road Fuquay-Varina, North Carolina 27526 USA
 www.southbendnc.com



Welcome to the Platinum Pro Series

Congratulations! You have selected a Platinum Pro Series oven engineered for precision probe cooking in demanding commercial kitchens. This manual provides instructions exclusively for probe cooking.

If you require installation instructions or information on conventional timer and oven temperature cooking, please refer to the following manuals:

- Gas Units: Manual # 1409003.
- Electric Units: Manual # 1409004.

RETAIN THIS MANUAL FOR FUTURE REFERENCE.

TABLE OF CONTENTS

Standard Control Panel ----- 3

 Control Panel Overview ----- 4

 Confirming Probe Readiness ----- 4

 Operation of Standard Model ----- 4

 Cooking Cycle ----- 5

 Post-Cooking Cycle ----- 5

Touchscreen (Wired) Control Panel ----- 6

 Control Panel Overview ----- 7

 How Probes Are Displayed ----- 7

 Confirming Probe Readiness ----- 7

Touchscreen (Wireless) Control Panel Operation ----- 8

 Control Panel Overview ----- 9

 How Probes Are Displayed ----- 9

 Confirming Probe Readiness ----- 9

 Pairing Probes ----- 9

Operations of Touchscreen Models ----- 10

 Manual Cooking ----- 11

 Recipe ----- 12–13

 Rack Cooking ----- 14

Configuration ----- 15

Read this manual carefully before attempting startup or using the probe cooking features. Proper understanding of the procedures will ensure accurate results, safe operation, and long-term performance of your oven.

For questions about probe cooking operation, maintenance, or service, contact:

Southbend
1100 Old Honeycutt Road
Fuquay-Varina, North Carolina 27526 USA

This manual covers the following control panels:

1. Standard Control Panel (Wired Probes)
2. Touchscreen Control Panel (Wired Probes)
3. Touchscreen Control Panel (Wireless Probes)

STANDARD CONTROL PANEL - WIRED PROBES

Figure 1

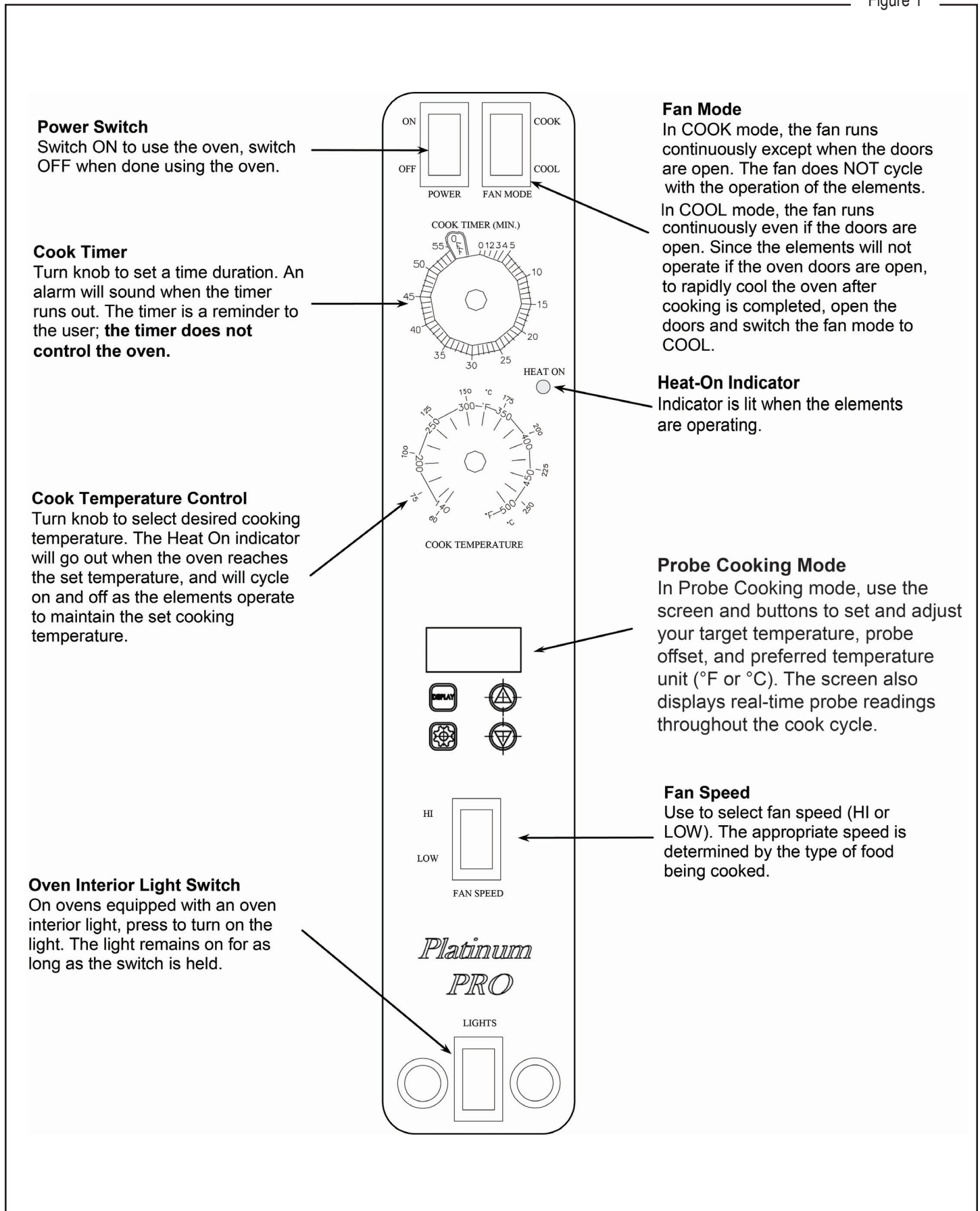

CONTROL PANEL OVERVIEW

- Two identical, interchangeable probes.
- Two fixed connectors labeled 1 and 2 inside the right oven cavity wall.
- Units are hardwired at the factory and cannot be reconfigured by the user.
- Probes appear on the display as “Probe 1” and “Probe 2,” based on the connector used.
- A compact digital display with buttons is dedicated to probe cooking functions.

CONFIRMING PROBE READINESS

1. Press the POWER button to turn the oven ON.
2. The compact digital screen should illuminate and display the probe status as “open.”
3. Insert both probes into connectors labeled 1 and 2. Either probe can go into either connector.
4. The compact digital screen should change from “open” to the current probe temperature reading.

Figure 2

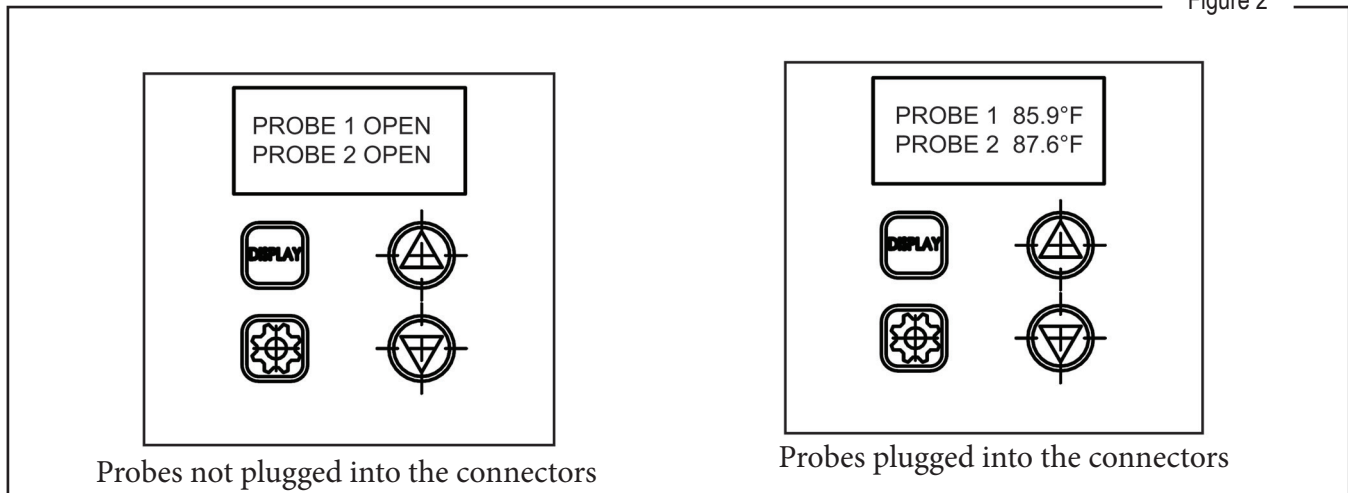

NOTICE

If the display does not show “open” when probes are unplugged or still shows “open” after the probes are connected, contact the manufacturer.

OPERATION OF STANDARD MODELS

Models with the standard control panel use traditional knobs and push buttons to turn the unit on and set cooking functions. However, for probe cooking, you will need to use the small compact digital screen.

SETUP

1. Flip the POWER switch to ON.
2. Turn the FAN MODE switch to COOK.
 - The fans will run continuously while the oven doors are closed. If set to COOL, the fans will run continuously even when the doors are open.
3. Adjust the OVEN TEMP dial to the desired cooking temperature.
 - The HEAT ON indicator will light while the burners are on and during preheating.
4. Set the FAN SPEED switch to HI or LOW, depending on your cooking needs.

PLATINUM PRO SERIES CONVECTION OVEN

5. Configuring Probe Settings

Figure 3

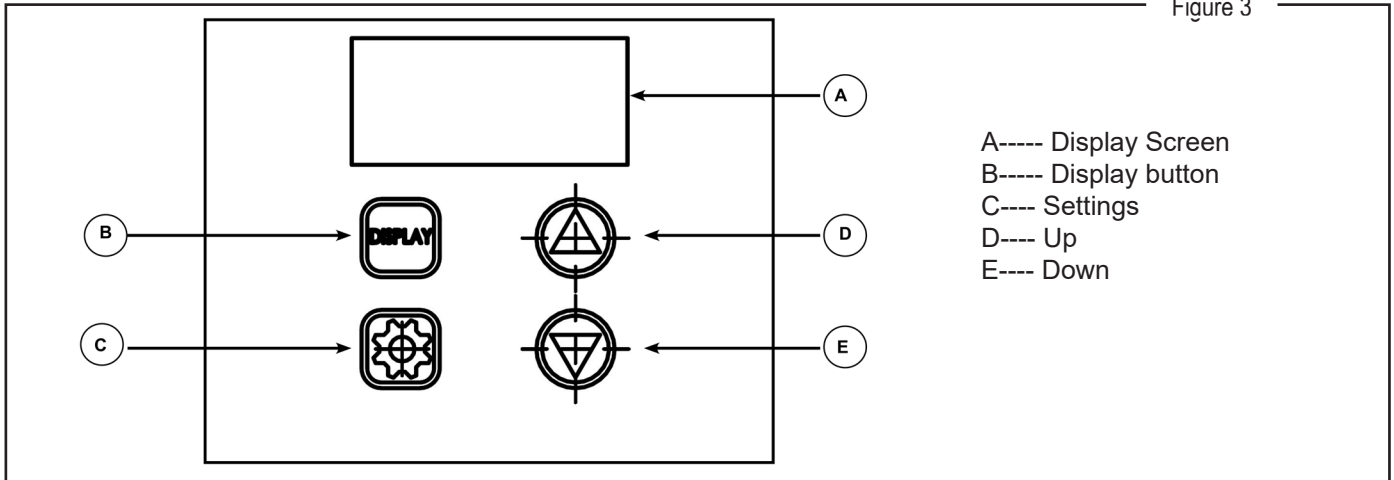

- A----- Display Screen
- B----- Display button
- C----- Settings
- D---- Up
- E---- Down

Setting the Target Internal Temperature

1. From the main screen, press the SETTINGS button to open the Setpoint Menu.
2. Press the SETTINGS button again to toggle between “Probe 1” and “Probe 2”.
3. Use the ▲ and ▼ arrows to adjust the target internal temperature in 1°F or 1°C increments.
4. Press the DISPLAY button to return to the main screen.

6. Wait for the oven to reach the set temperature.

The HEAT ON indicator will cycle on and off three times before going off to confirm temperature stabilization.

COOKING CYCLE

1. Insert the probes into the thickest part of the food.
2. Load the food into the oven, plug probes into the probe connectors and close the doors.

NOTICE

The oven's contents, components, and doors will be hot during operation. Use caution when loading or unloading food.

3. To view the interior during cooking, press and hold the LIGHT switch found at the bottom of the control panel.
Note: The light stays on only while the switch is held. Releasing it will turn the light off.
4. When the food reaches the target internal temperature, the oven will beep continuously until the alert is cleared.
5. Carefully open the oven doors, remove the food, and unplug the probes from the connectors.

Post-Cooking Cycle

1. To rapidly cool the oven:
 - Turn the COOK TEMP dial fully counterclockwise to the lowest setting and open oven doors.
 - Set FAN MODE to COOL and Set FAN SPEED to HI.
2. Once the unit has cooled, switch POWER to OFF.

TOUCHSCREEN CONTROL PANEL- WIRED PROBES

Figure 4

Power Switch

Flip the switch ON to operate the oven.
Turn it OFF when cooking is complete or the oven is not in use.

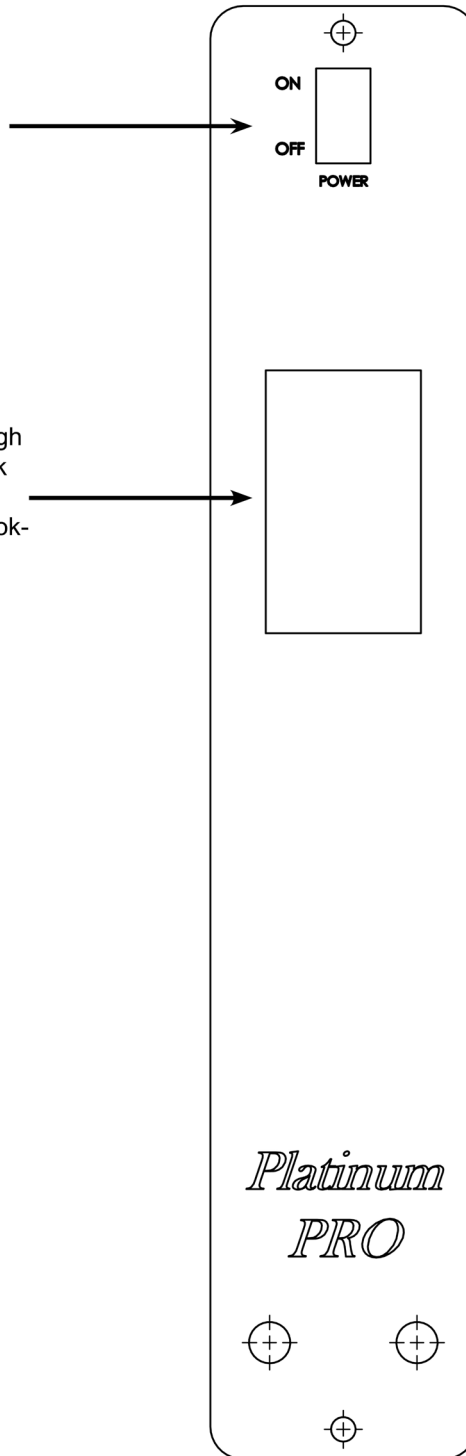

Digital Touch Control Panel

All oven functions are accessed through this panel, including temperature, cook time, lighting, and fan speed settings. Specialized modes such as Probe Cooking, Fan Pulse, and Cook & Hold are also available from this interface.

PLATINUM PRO SERIES CONVECTION OVEN

CONTROL PANEL OVERVIEW

- Two identical, interchangeable wired probes.
- Two fixed connectors labeled 1 and 2 inside the right cavity wall.
- Units are hardwired at the factory and cannot be modified by user.
- Touchscreen display for interactive oven control.
- Probes labeled on-screen as “Probe 1” and “Probe 2”.
- Visual icons: black and white icon for Probe 1; green icon for Probe 2.

HOW PROBES ARE DISPLAYED ON SCREEN

The oven has two probe connectors: Connector 1 and Connector 2.

- A probe plugged into Connector 1 is shown as Probe 1, and one in Connector 2 is shown as Probe 2.

1. Bottom Ribbon Display (on any page): Both probes are represented by a white probe icon.
 - Probe 1 information appears in white next to the icon.
 - Probe 2 information appears in green next to the icon.
2. Assigning Page Display
 - Probe 1: Black icon with white text.
 - Probe 2: Green icon with green text.

CONFIRMING PROBE READINESS

1. Flip the POWER switch to turn the oven ON.
2. Press the center POWER button on the touchscreen to activate the display.
3. A probe icon should appear on the bottom ribbon, showing “---”.



4. Insert the probes into the connectors inside the right oven cavity wall.
5. The bottom ribbon should now display the current probe temperature in place of the “---”.

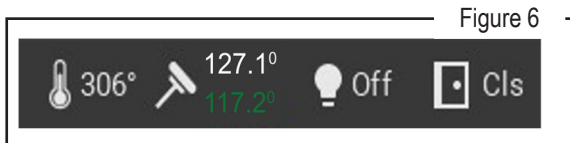

TOUCHSCREEN CONTROL PANEL- WIRELESS PROBES

Figure 7

Power Switch

Flip the switch ON to operate the oven.
Turn it OFF when cooking is complete or the oven is not in use.

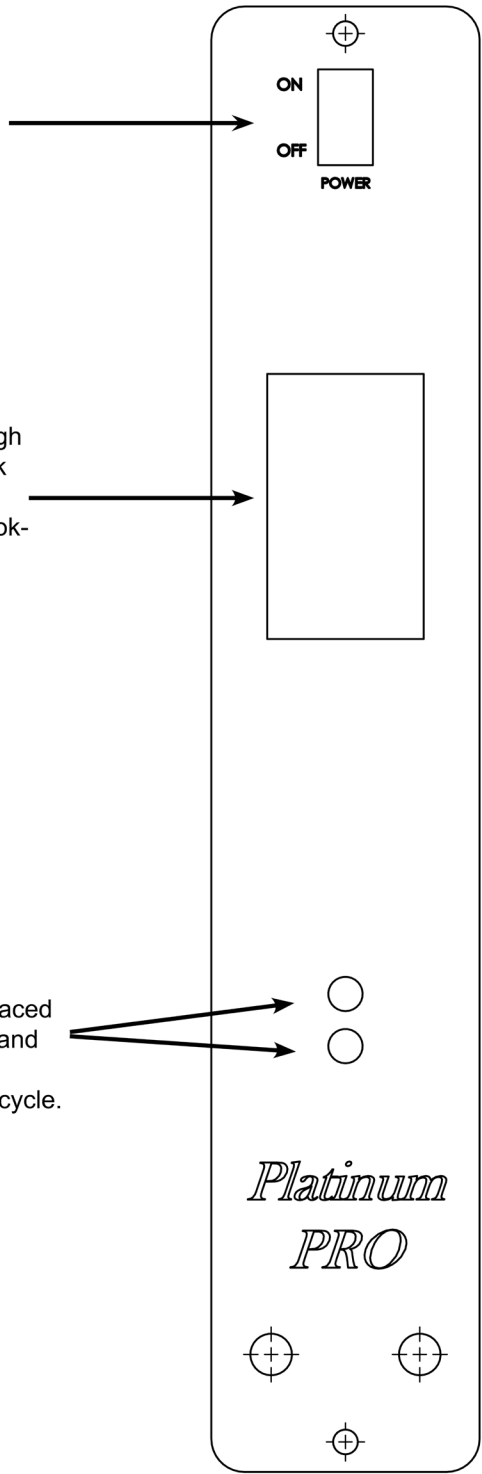

Digital Touch Control Panel

All oven functions are accessed through this panel, including temperature, cook time, lighting, and fan speed settings. Specialized modes such as Probe Cooking, Fan Pulse, and Cook & Hold are also available from this interface.

Charging Dock

When not in use, probes should be placed in the charging dock for safe storage and recharging. This dock keeps probes powered and ready for the next cook cycle.

PLATINUM PRO SERIES CONVECTION OVEN

CONTROL PANEL OVERVIEW

- Two wireless probes.
- Each probe has a unique identification number engraved on its shaft.
- Probes feature distinct handle colors (green and black) for easy on-screen identification.
- Probes are charged and stored on the control panel when not in use.
- Probes are pre-paired to the oven at the factory.
- Touchscreen display for interactive oven control.

HOW PROBES ARE DISPLAYED ON SCREEN

There are two wireless probes, each with:

- A unique serial number.
- A colored handle: green or black.

1. Pairing Page Display

- Each probe appears with its serial number and a probe icon that matches the handle color.

2. Bottom Ribbon Display (on any page): Both probes are represented by a white probe icon.

- The probe with the black handle displays its information in white.
- The probe with the green handle displays its information in green.

3. Assigning Page Display

- Each probe appears with a probe icon in its handle color.
- The probe with the black handle displays its information in white.
- The probe with the green handle displays its information in green.

CONFIRMING PROBE READINESS

1. Flip the POWER switch to turn the oven ON.
2. Press the center POWER button on the touchscreen to activate the display.
3. A probe icon should appear on the bottom ribbon, showing “”.
4. Remove the probes from the charging dock.
5. The bottom ribbon should now display the current probe temperature in place of the “---”.

If the probes display “---”, follow the pairing instructions.
Make sure the probes are fully charged before trying to pair.

PAIRING WIRELESS PROBES

Press the probe icon on the bottom ribbon.

AUTOMATIC PAIRING:

1. Confirm AUTOMATIC PAIRING is ON.
2. Remove both probes from the dock.
3. Hold one probe near the control panel.
4. Press the PAIR button on the probe.
5. The probe will connect automatically. Its serial number and live temperature will appear on-screen.

MANUAL PAIRING:

1. Slide the AUTOMATIC PAIRING to OFF.
2. Press the PAIR button on the desired probe.
3. Manually enter the probe's serial number into the touchscreen.
4. Confirm pairing; the probe's serial number and temperature will display.

Figure 8

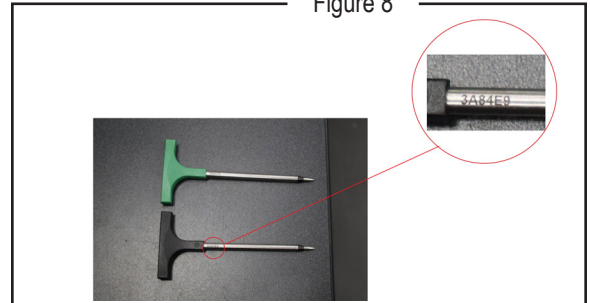
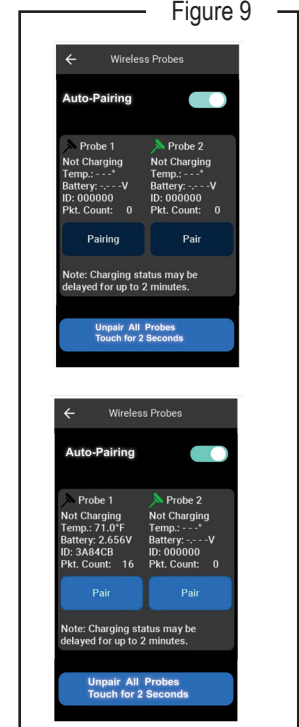

Figure 9



OPERATION OF TOUCHSCREEN MODELS

MAIN SCREEN

1. **Power Switch** – Flip **ON** to start the oven.
2. **Power Button** – Tap to enter Cooking Mode.
3. **Lights** – Tap to turn oven light **ON** or **OFF**.
 - When ON, the bulb icon glows yellow.
 - The light can be turned OFF from any screen.

NOTICE

Not all units have lights installed. The button will still be present.

Turning the light ON with one page will continue to keep the light on through the different pages.

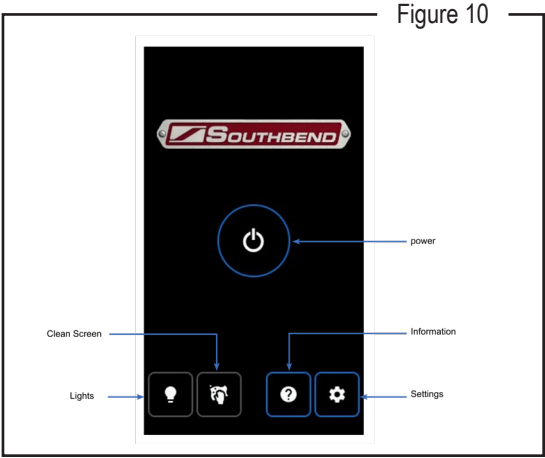

4. **Clean Screen** – Press and hold the button unit countdown wheel appears in the center.
 - The screen locks for 20 seconds so it can be wiped clean.
 - Once the timer reaches 0, the screen unlocks.
5. **Information** – Shows app version, build date, and boot version.
6. **Settings** – Opens Settings (see Configuration section).

COOKING MODE PAGE

1. **Power Button** – Returns to the Main Screen and stops all cooking, heat, and fans.
2. **Manual** – Set cooking parameters manually.
3. **Recipe** – Use saved recipes (created or imported via USB).
4. **Rack** – Cook multiple recipes with the same fan speed and oven temp.
5. **Clean Screen** – Same as on Main Screen.
6. **Cool Down** – Activates fast fan, turns off heat, and returns to Main Screen.
 - The Cool Down cycle ends automatically when:
 - Internal temperature drops below 130°F / 55°C.
 - Cook mode is started.
 - The Power button is pressed again.
7. **Information** – Same as Main Screen.
8. **Settings** – See Configuration section.

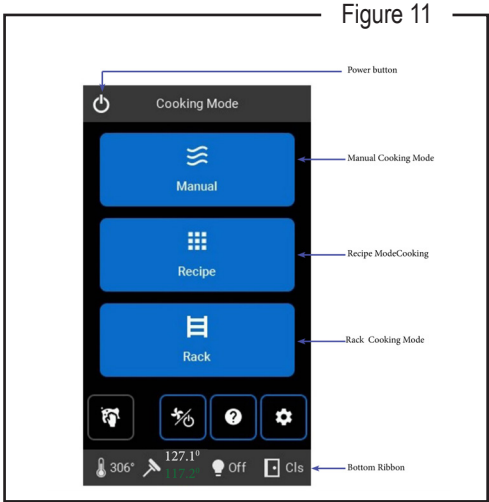

Bottom Ribbon (always visible)

9. **Internal Temperature** – Shows current oven temp.

10. **Probes** – Shows current probe temperatures.

11. **Lights** – Same as Main Screen.

12. **Door Indicator** – Shows if the door is open or close.

MANUAL COOKING

SETUP

1. From the Home Screen, tap Manual Cook.
 - The oven will start preheating.
 - The top ribbon will say "PREHEATING."
2. Tap the ▼ arrow next to Cook Mode to open probe selection:
 - Deselect all probes for timer-only cooking.
 - Select 1 probe for single-probe cooking.
 - Select both for dual-probe cooking.
3. Tap ▲ to close the probe menu.
4. Set oven temperature:
 - Use + / - to adjust in 10°F steps.
 - Or tap the temperature to enter manually.
5. Set probe temperature(s):
 - Use + / - to adjust in 1°F steps.
 - Or tap the probe temperature to enter manually.
6. Set Fan Speed: High or low.
7. Set Delay Time: Pauses heat and fan before cooking starts.
8. Set Pulse Settings: Turns fan and heat on/off during cooking.
9. Tap Cook and Hold to enable or disable.
 - Keeps cabinet warm after cooking finishes.
 - Requires a hold temperature within cook temperature limits.
10. When the oven is ready:
 - The top ribbon will say READY.
 - The Cook button becomes pressable.
11. Load your food and press Cook.

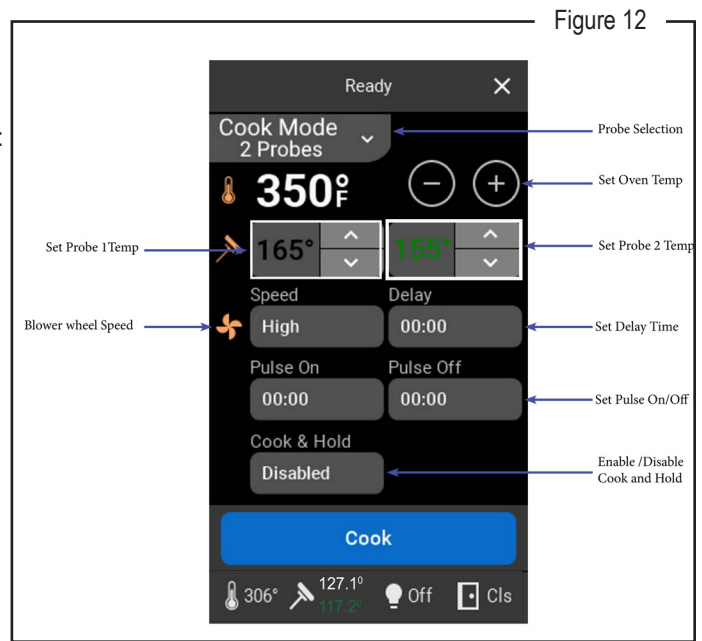

Figure 12

NOTICE

When using wireless probes:

- Insert the entire metal shaft to prevent probes from damage.
- Do not leave probes inside a hot oven.
- If the shaft temperature exceeds 210°F (99°C), the probe may be damaged.

COOKING CYCLE OVERVIEW

- During an active cooking cycle, the screen shows:
- Assigned probes with their target and current temperatures.
 - Current Oven Temperature.
 - Blower Speed (Fast or Slow).
 - Remaining Delay Time (if applicable).
 - Pulse feature status (On/Off).
 - Cancel button to stop the cook cycle.

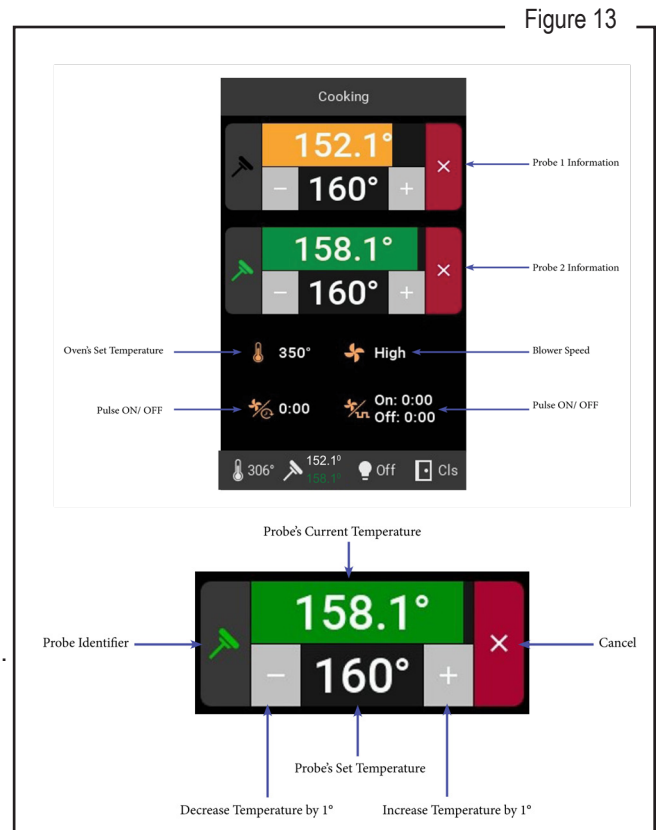

Figure 13

RECIPES

Recipes can be imported ahead of time using the service USB input or can be manually created by pressing the New button. Recipes allow users to perform complex cooking operations with up to 5 different stages of cooking temperatures, blower speeds, delays, and/or pulses. This section will cover how to create a new recipe and operate a probe set recipe.

CREATE A NEW RECIPE

1. Tap **New Recipe** (icon appears at end of recipe list).
2. Tap the **food icon** to select an image for your recipe.
 - Once selected, tap the ** ← **.
3. Enter your **recipe name**, then tap the ** → ** to confirm.
4. Set up the first cooking stage by adjusting:
 - Oven temperature.
 - Time/Probe temperature.
 - Fan speed.
 - Delay (if needed).
 - Pulse (on or off).

Note: If the screen only shows a timer icon and not probe options, tap the **timer icon** to switch to probe icon.



5. To add more cooking stages, tap the **Stage dropdown menu**.
 - You can add up to 5 stages. (You can mix Time and Probe stages)
 - A Cook & Hold stage can also be added at the end (this does not count as one of the 5 stages).
6. Tap **Test** to run the recipe if you'd like to preview how it cooks.
7. Tap **Save** to store your recipe and X to exit the page.
 - If you try to exit (by tapping X) without saving, a popup will ask if you want to save your changes.

Your recipe should now appear on the main recipes page.

Figure 14

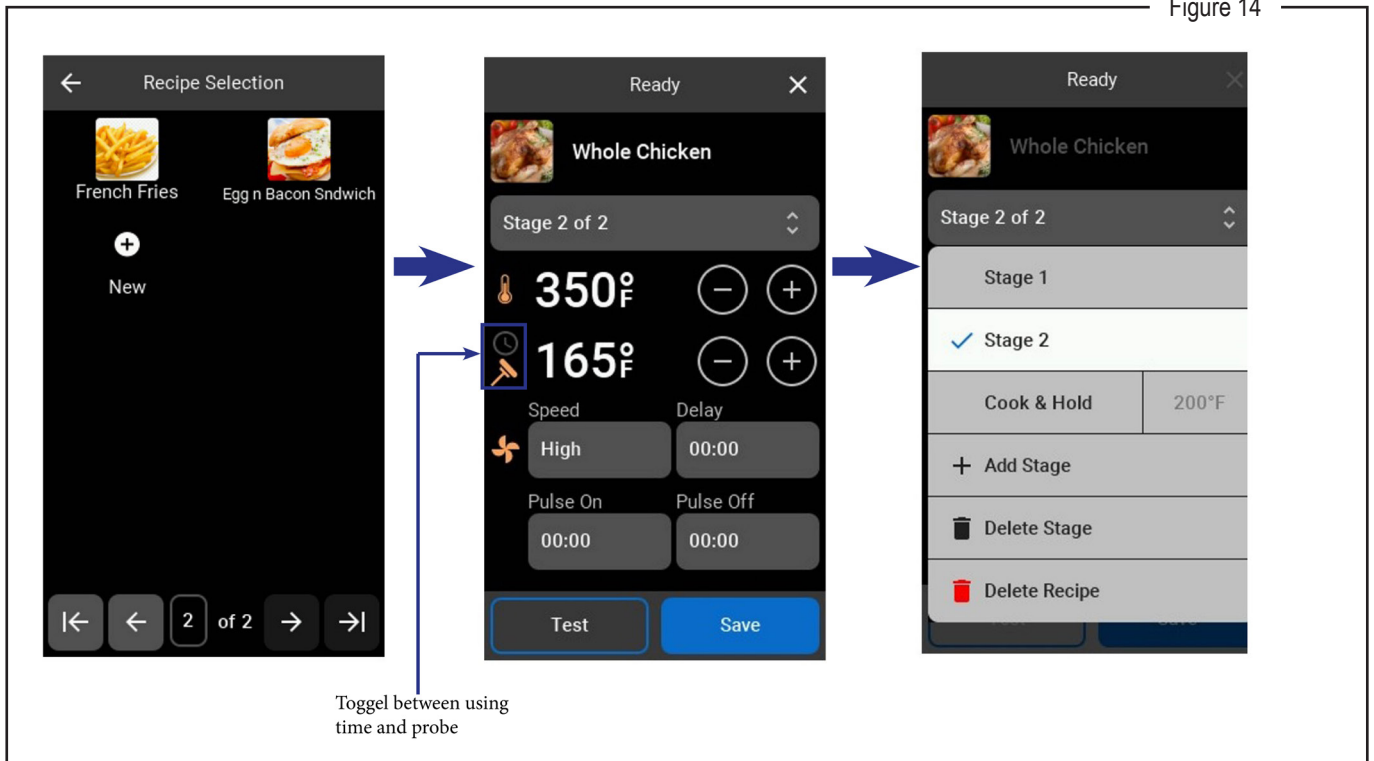

PLATINUM PRO SERIES CONVECTION OVEN

RUNNING A PROBE ENABLED RECIPE

1. From the Home Screen, tap **Recipe**.
2. Select the recipe you want to run.
 - A preview will display all cooking stages and settings.
3. The top ribbon will say **PREHEATING** while the oven warms up.
4. Assign one or both probes to the recipe.
 - A probe can only be assigned once.
5. Once the oven is ready, the top ribbon will change to **READY**, and the **Cook** button will become active.
6. Load your food, close the oven door, and tap **Cook** to begin.

Figure 15

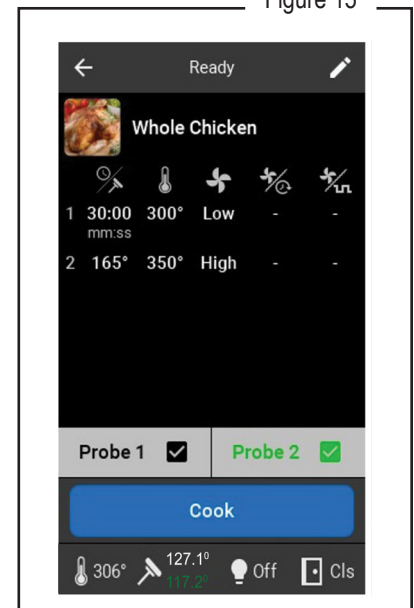

NOTICE

When using wireless probes:

- Insert the entire metal shaft to prevent probes from damage.
- Do not leave probes inside a hot oven.
- If the shaft temperature exceeds 210°F (99°C), the probe may be damaged.

COOKING CYCLE OVERVIEW

During an active cooking cycle, the screen shows:

- Assigned probes with their target and current temperatures.
- Current Oven Temperature.
- Blower Speed (Fast or Slow).
- Remaining Delay Time (if applicable).
- Pulse feature status (On/Off).
- Cancel button to stop the cook cycle.

Figure 16

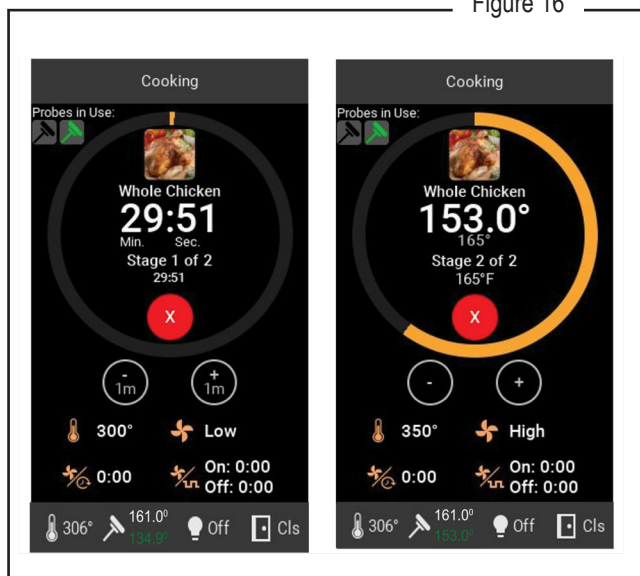

RACK COOKING

Rack Cooking lets you cook multiple recipes at once that use the same temperature and fan speed. You must first group compatible recipes.

CREATING A RACK GROUP

1. Tap the edit pen icon (top-right).
2. A new square will appear at the end of the Group page. Tap it.
3. Enter a group name and tap the blue arrow to confirm.
4. Select your base recipe and up to 3 more recipes.
 - Other recipes compatible with the base recipes will appear once you select your base recipe.
5. Tap Save when finished.

RUNNING A RACK GROUP

1. Tap Rack from the Cooking Mode page.
2. Select a Group
 - Oven begins preheating automatically.
3. To assign a recipe, tap the food icon in the top-right corner to open the recipe menu.
4. Select a recipe from the list. The screen will return to the assignment page, where you can choose a rack and assign probes. A recipe icon will appear on the rack once the recipe is assigned.
5. Repeat for all racks in the group.
6. The top ribbon will change to READY and the Start button becomes active.
7. Tap Start to begin.
8. Tap the red X to cancel and reset that rack's cooking.

Figure 17

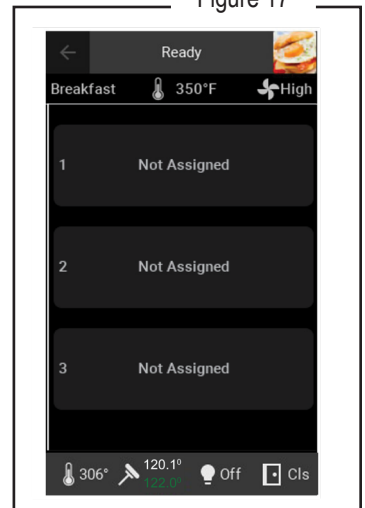

Figure 18

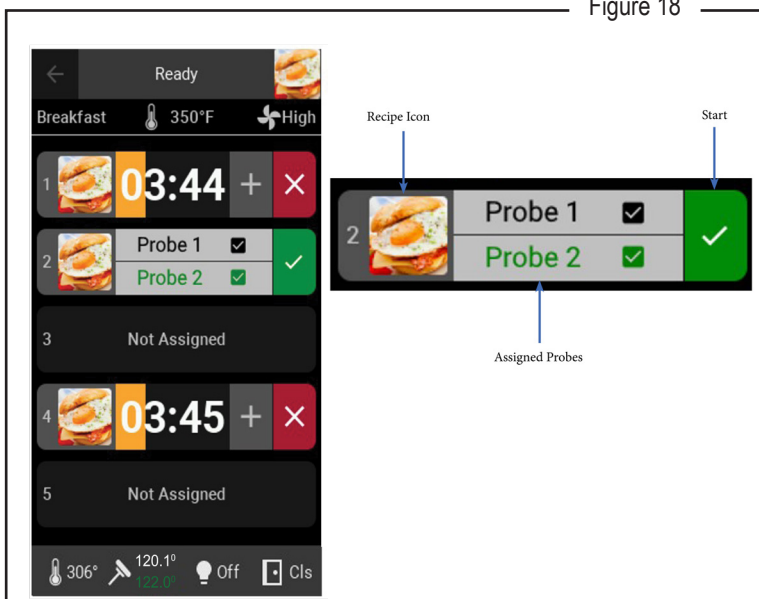
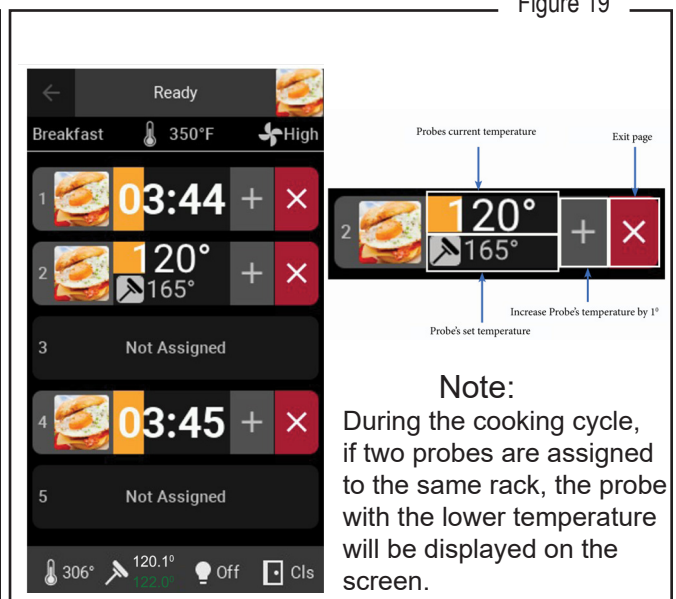

Figure 19



CONFIGURATION

SERVICE ONLY USB ACCESS

The access to the USB port to import/export recipes, update the software versions and add Icons is found on the back of the control panel. Remove the two screws securing the control panel and pull out. Underneath the digital display you will find the USB port. If importing files, make sure that the unit is off before inserting the USB drive, and then turn it on. There will be a slight delay compared to normal operation and the file(s) will automatically load. Created Icons must be bitmap file type. Recipes will need to be created on the touchscreen before export.

SETTINGS

1. **Back Button** – Returns to the previous screen.
2. **Setup** – Passcode protected parameter configurator.
 - Manager passcode allows owners to change limited unit variables.

MANAGER PASSCODE: 6647

3. **Service** – Passcode protected unit health and I/O test panel with current input readings.



SETUP

Enter manager provided code to enter the Setup Parameters page.

1. **Units** – Toggles between °F and °C.
2. **Time & Date** – Used to record faults.
3. **Buzzer Volume** – Toggle between High, Medium, and Low.
4. **Allow Editing** – Toggle between Yes, Passcode, and No. This setting is in reference to editing recipes and groups. Selecting Passcode will require manager code to edit while selecting No will remove the edit button from pages.
5. **Cook Modes** – Choose which cooking modes will be active on the Cooking Mode page.
6. **Ready Offset** – The oven will allow cook start operations if the cavity temperature is within the offset value from the cook setpoint.
7. **Group Temp Allowance** – Recipes can be grouped if their setpoints differ by allowance value or less.
8. **Replace All Existing Icons?** – Deletes current icons for recipes and uploads new ones if USB is inserted into USB slot. Full icon packs are only updated by Ametek.
9. **Fault Log** – View all logged faults with the date and time of occurrence.
10. **Reset to Factory Defaults** - Resets all system parameters and settings to original factory values.
11. **Recipes** – Allows Import and Export from USB to keep and manage recipes. Another option is to delete all recipes from unit. Deleting all recipes will also delete them from Rack Groups.

SERVICE

The Service Screen displays current input values and allows service technicians to test all inputs and outputs. Please contact the manufacturer for the passcode.

WIRELESS PROBES ONLY:**INTERFERENCE STATEMENT:**

This equipment has been tested and found to comply with the limits for a Class B digital device, pursuant to Part 15 of the FCC Rules. These limits are designed to provide reasonable protection against harmful interference in a residential installation. This equipment generates uses and can radiate radio frequency energy and, if not installed and used in accordance with the instructions, may cause harmful interference to radio communications. However, there is no guarantee that interference will not occur in a particular installation. If this equipment does cause harmful interference to radio or television reception, which can be determined by turning the equipment off and on, the user is encouraged to try to correct the interference by one of the following measures:

1. Reorient or relocate the receiving antenna.
2. Increase the separation between the equipment and receiver.
3. Connect the equipment into an outlet on a circuit different from that to which the receiver is connected.
4. Consult the dealer or an experienced radio/TV technician for help.

CAUTION:

Changes or modifications not expressly approved by the party responsible for compliance could void the user's authority to operate the equipment

INTERFERENCE COMPLIANCE STATEMENT - FCC ID 2BG32-TTMP1:

This device complies with part 15 of the FCC Rules. Operation is subject to the following two conditions:

- (1) This device may not cause harmful interference, and
- (2) this device must accept any interference received, including interference that may cause undesired operation

PLATINUM PRO SERIES CONVECTION OVEN



PLATINUM PRO SERIES CONVECTION OVENS



A product with the Southbend name incorporates the best in durability and low maintenance. We all recognize, however, that replacement parts and occasional professional service may be necessary to extend the useful life of this appliance. When service is needed, contact a Southbend Authorized Service Agency, or your dealer. To avoid confusion, always refer to the model number, serial number, and type of your appliance.



SOUTHBEND
 **MIDDLEBY** A Middleby Company
1100 Old Honeycutt Road Fuquay-Varina, North Carolina 27526 USA
www.southbendnc.com