

PARTS LIST AND EXPLODED VIEWS

SONY : **KDL40V2500**

WAX2F CHASSIS

<u>MODEL NAME</u>	<u>REMOTE COMMANDER</u>	<u>DESTINATION</u>
KDL-40V2500	RM-YD012	CANADA
KDL-40V2500	RM-YD012	US



KDL-40V2500



RM-YD012

LCD DIGITAL COLOR TELEVISION

3-5. SEMICONDUCTORS

IC

BA00AST-V5

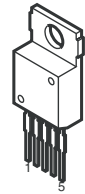

BA05FP-E2
BA09FP-E2
S-1111B33MC-NYSTFG
S-80928CNMC-G8YT2G
TC7SZ125FU(TE85R)

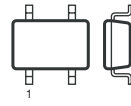

5Pin CHIP

BA18BC0FP-E2
BA25BC0FP-E2

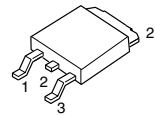

BR24L02F-WE2
CS4335-KSZR
FA5501N-TE1
LM75CIMX-3
M24128-BWMN6T(A)
M24C02-WMN6T(B)
NJM2521V(TE2)
NJM3414AV(TE2)
RC4558DR
RC4558PWR

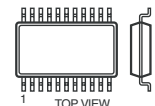

8Pin SOP

CD4052BNSR
FMS6418AM16X

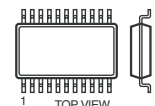

16Pin SOP

CXA2188Q-T4

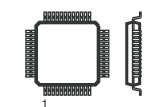

40Pin QFP

EM6A9320BI-5MG

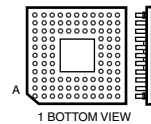

144Pin PGA

HD6433692A39FXV
HD64F3694FXV-DA4
TPA3004D2PHPR

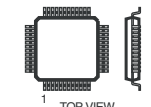

48Pin QFP

HD64F2378-12681-01

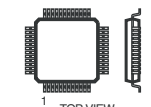

144Pin QFP

L88M05T-FA-TL

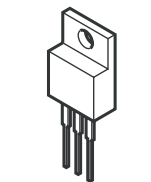

M52347FP-TE

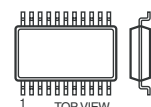

20Pin SOP

MM1431ATT

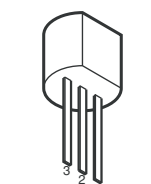

NJW1149AFH1

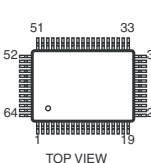

PQ1CY1032ZP

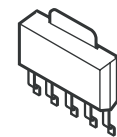

PQ1CZ41H2ZPH

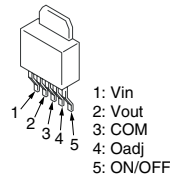

1: Vin
2: Vout
3: COM
4: Oadj
5: ON/OFF

RV5C387A-E2-FB

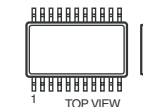

SIH9993CTG100

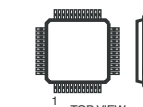

100Pin QFP

SN74LV132APWR
SN74LVC14APWR

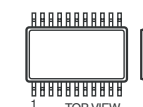

14Pin SOP

STR-A6169

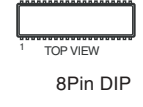

8Pin DIP

TK11819MTL

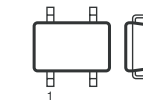

6Pin CHIP

TRANSISTOR

DTC114EU
DTC114EUAFT106

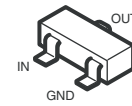

DTC114EUA-T106
DTC115EUA-T106
DTC144WKA-T146
DTC314TK-T-146
DTC323TK
DTC323TKT146
MUN2211T1
MUN2212T1
MUN5213T1
PDTC114EK-115
UN2211
2PA1576R-115
2PC4081R-115
2PD601AR-115
2SA1037AK-T146-QR
2SA1037AK-T146-R
2SA1576A-T106-QR
2SA1774R
2SA1774TL-QR
2SC1623-L5L6
2SC2412K-T-146-QR
2SC4081-R
2SC4081T106R
2SC4617R
2SC4617TL-QR
2SD2114K
2SD601A-Q-TX

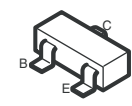

FDS6690A

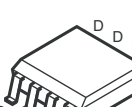

HN1B01FU-TE85R

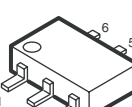

SSM6N15FU(TE85R)

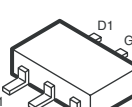

2SB1122-S
2SB1122-ST-TD-E
2SD1621-ST
2SD1621ST-TD-E

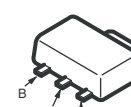

2SD2114KT146

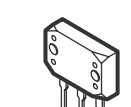

2SK2158-T2B

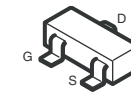

DIODE

BAS316-115
EP05FA20
MM3Z10VT1
MM3Z11VT1
MM3Z13VT1
MM3Z18VST1
MM3Z22VT1
MM3Z2V4T1
MM3Z5V6ST1
MM3Z6V2ST1
MM3Z6V8ST1
MM3Z8V2ST1

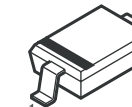

BAT54HT1
DTZ10B
HZU5.6GTRF
MA113-(TX)
MMDL914T1
RD5.6SB-T1
UDZ-TE-17-18B
UDZ-TE-17-6.2B
UDZ-TE-17-6.8B



D10SBS4
D10SBS4F
D2SB60A-F04
D4SB60L

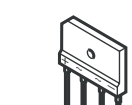

D10SC6M

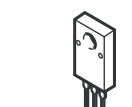

D1NL40-TA2
D1NL40-TR2
ERA22-08

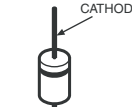

D1NS6
D1NS6-TR
ERA22-06AVRBT
UF4005PKG23
10ERB20-TB3
1N5404TU

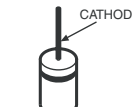

EC10QS-04
EC10QS04-TE12L5



EC21QS03L-TE12L
P6SMBJ30A-5
PTZ-TE25-3.9B



ERA22-08KFLB

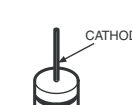

FSF05A60



HN1D03FU-TE85L
HN1D03FU-TE85R

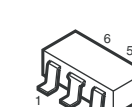

M1FM3

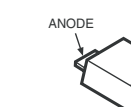

MA132WK
MA132WK-TX
MA151WK-TX
1SS184

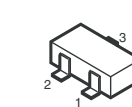

UDZSTE-1710B



UMZ16NT106

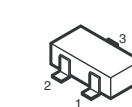

1PS302

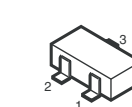

SML-020MVT-T86

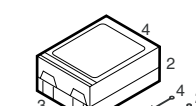

SML-310LTT86

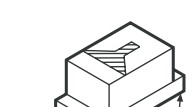



SECTION 4: EXPLODED VIEWS

Components not identified by a part number or description are not stocked because they are seldom required for routine service.

The component parts of an assembly are indicated by the reference numbers in the far right column of the parts list and within the dotted lines of the diagram.

* Items marked with an asterisk are not stocked since they are seldom required for routine service. Expect some delay when ordering these components.

NOTE: The components identified by shading and  mark are critical for safety. Replace only with part number specified.

NOTE: Les composants identifiés par un triangle et une marque  sont critiques pour la sécurité. Ne les remplacer que par une pièce portant le numéro spécifié.

NOTE: The components identified by a red outline and a  mark contain confidential information. Specific instructions must be adhered to whenever these components are repaired and/or replaced. See Appendix A: Encryption Key Components in the back of this manual.

4-1. REAR CABINET AND STAND ASSEMBLY

■	7-685-648-79	SCREW +BVTP 3X12 TYPE2 IT-3
☆	2-580-640-01	SCREW, +BVTP2 4X16
●	2-580-647-01	SCREW, +KTP2 4X12
○	2-580-611-01	SCREW, +PSW M6X16
▼	2-689-628-01	SCREW, (B) 5X30
▽	2-580-590-01	SCREW, +PSW M3X5

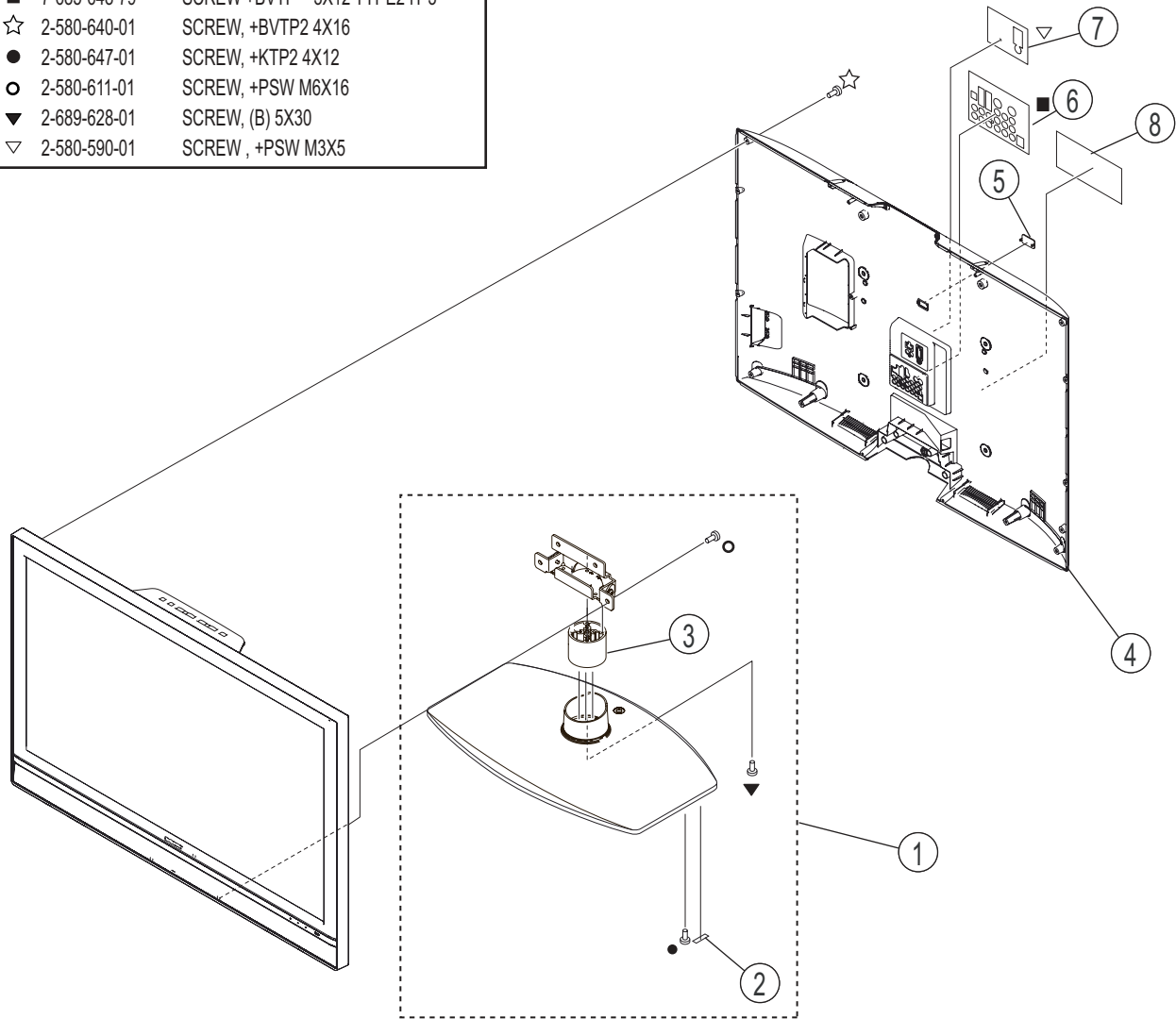

REF. NO.	PART NO.	DESCRIPTION	[ASSEMBLY INCLUDES]	REF. NO.	PART NO.	DESCRIPTION	[ASSEMBLY INCLUDES]
1	A-1205-240-A	STAND ASSY (ML) (KDL-40V2500 ONLY)	[2-3]	5	2-664-636-01	COVER, ECS	
1	A-1214-954-A	STAND ASSY (L) (KDL-46V2500/46V25L1 ONLY)	[2-3]	6	2-890-854-01	LABEL, TERMINAL REAR	
2	2-886-221-01	FOOT		7	2-890-855-01	LABEL, HDMI	
* 3	2-687-400-01	NECK (L)		* 8	2-689-075-11	LABEL, INFORMATION (KDL-40V2500 ONLY)	
4	X-2148-132-1	COVER, REAR ASSY (40) (KDL-40V2500 ONLY)		* 8	2-689-075-01	LABEL, INFORMATION (KDL-46V2500 ONLY)	
4	X-2148-133-1	COVER, REAR ASSY (46) (KDL-46V2500/46V25L1 ONLY)		* 8	2-894-182-01	LABEL, INFORMATION (KDL-46V25L1 ONLY)	

NOTE: The components identified by shading and  mark are critical for safety. Replace only with part number specified.



NOTE: Les composants identifiés par un trame et une marque  sont critiques pour la securite. Ne les remplacer que par une piece portant le numero specifie.

NOTE: The components identified by a red outline and a  mark contain confidential information. Specific instructions must be adhered to whenever these components are repaired and/or replaced. See Appendix A: Encryption Key Components in the back of this manual.

4-2. CHASSIS

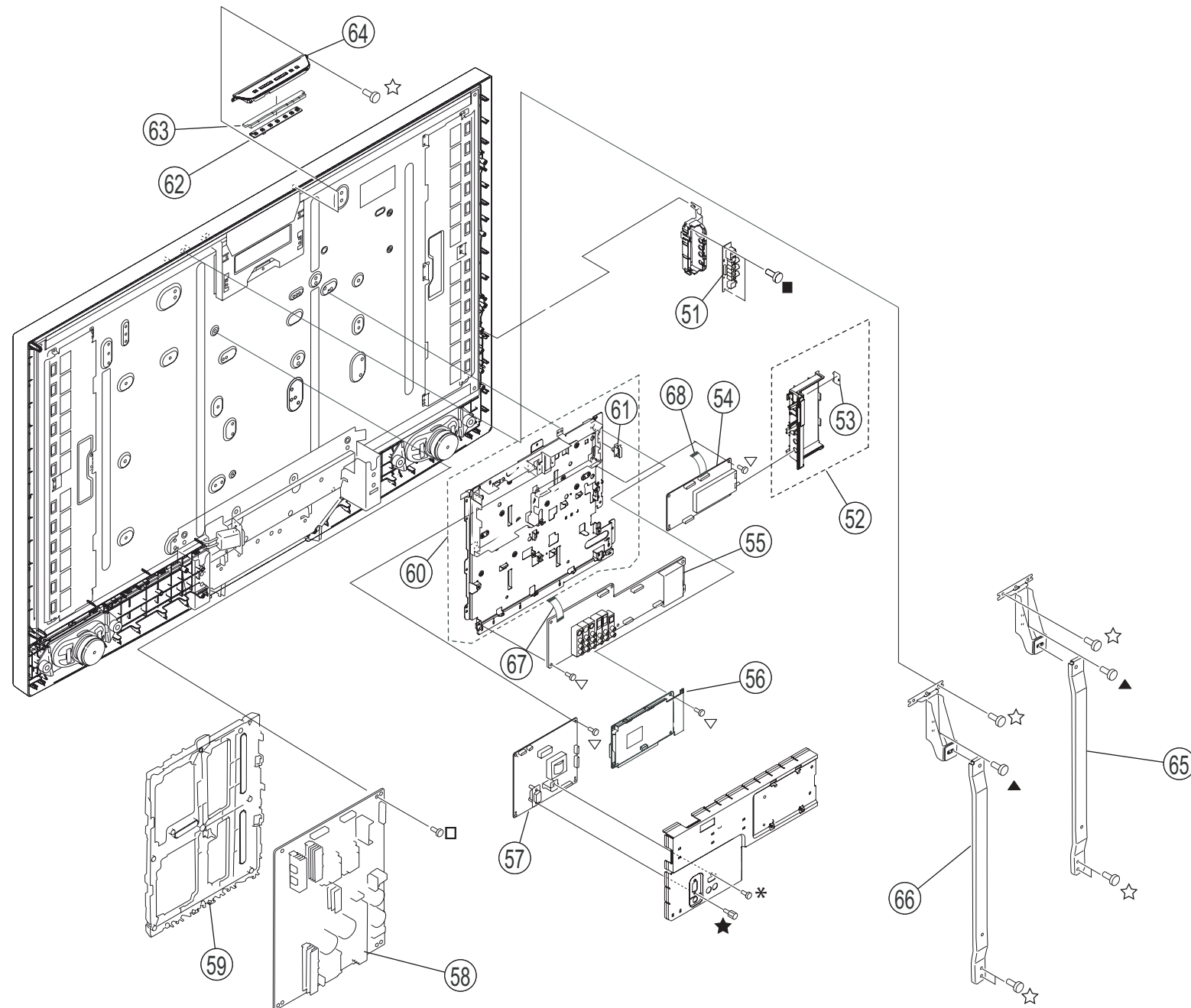
- 7-685-648-79 SCREW +BVTP 3X12 TYPE2 IT-3
- 2-674-965-31 SCREW, +PSW 3SG
- ★ 4-635-966-01 SCREW (HEX)
- ☆ 2-580-640-01 SCREW, +BVTP2 4X16
- ▽ 2-580-629-01 SCREW, +BVST 3X8
- * 2-580-590-01 SCREW, +PSW M3X5
- ▲ 2-580-606-01 SCREW, +PSW M5X8



REF. NO.	PART NO.	DESCRIPTION	[ASSEMBLY INCLUDES]	REF. NO.	PART NO.	DESCRIPTION	[ASSEMBLY INCLUDES]
51	A-1196-571-A	H2U BOARD, MOUNTED		60	X-2149-117-2	BRACKET, CHAS ASSY (A)	[61]
52	X-2149-053-3	SIDE, TERMINAL (A) ASSY (KDL-40V2500/46V2500 ONLY)		61	2-650-770-21	SLIDE, CLAMP	
52	X-2176-201-1	TERMINAL (A) ASSY, SIDE (KDL-46V25L1 ONLY)		62	A-1196-570-A	H1U BOARD, MOUNTED	
53	2-697-510-03	COVER, MS/USB		63	2-663-977-01	BUTTON, MULTI (KDL-40V2500/46V2500 ONLY)	
54	A-1164-341-B	QT BOARD, COMPLETE		63	2-890-850-01	BUTTON, MULTI (KDL-46V25L1 ONLY)	
Due to the complexity of this board, performing component level field repairs is not recommended. If service is required, complete board replacement is the preferred repair method. (If the tuner needs to be replaced, the complete QT Board must be ordered. It cannot be ordered separately.)				64	2-663-978-02	COVER, BUTTON (KDL-40V2500/46V2500 ONLY)	
55	A-1184-344-A	AU BOARD, MOUNTED		64	2-890-851-01	COVER, BUTTON (KDL-46V25L1 ONLY)	
56	A-1219-286-A	QSF BOARD, MOUNTED (SERVICE)		65	X-2109-058-3	VESA BRACKET (40) L ASSY (KDL-40V2500 ONLY)	
Due to the complexity of this board, performing component level field repairs is not recommended. If service is required, complete board replacement is the preferred repair method.				65	X-2109-250-5	ARM, VESA (46) L ASSY (KDL-46V2500/46V25L1 ONLY)	
	57	A-1196-624-A	BU BOARD, MOUNTED (SERVICE) (KDL-40V2500 ONLY)	66	X-2109-059-3	VESA BRACKET (40) R ASSY (KDL-40V2500 ONLY)	
	57	A-1196-664-A	BU BOARD, MOUNTED (SERVICE) (KDL-46V2500/46V25L1 ONLY)	66	X-2109-251-5	ARM, VESA (46) R ASSY (KDL-46V2500/46V25L1 ONLY)	
*	58	A-1184-357-B	G2A BOARD, MOUNTED	67	1-910-024-82	FFC CONNECTOR ASSY (1) 49P	
	59	2-664-617-01	BRACKET, G2 (KDL-40V2500/46V2500 ONLY)	68	1-910-024-84	FFC CONNECTOR ASSY 40P	

NOTE: The components identified by shading and  mark are critical for safety. Replace only with part number specified.

NOTE: Les composants identifiés par un trame et une  sont critiques pour la sécurité. Ne les remplacer que par une pièce portant le numéro spécifié.

NOTE: The components identified by a red outline and a  mark contain confidential information. Specific instructions must be adhered to whenever these components are repaired and/or replaced. See Appendix A: Encryption Key Components in the back of this manual.

4-3. SPEAKERS

◇	2-596-649-01	+KTT 3X10 (S TYPE)
☆	2-580-640-01	SCREW, +BVTP2 4X16
▲	2-580-606-01	SCREW, +PSW M5X8
△	2-580-600-01	SCREW, +PSW M4X8

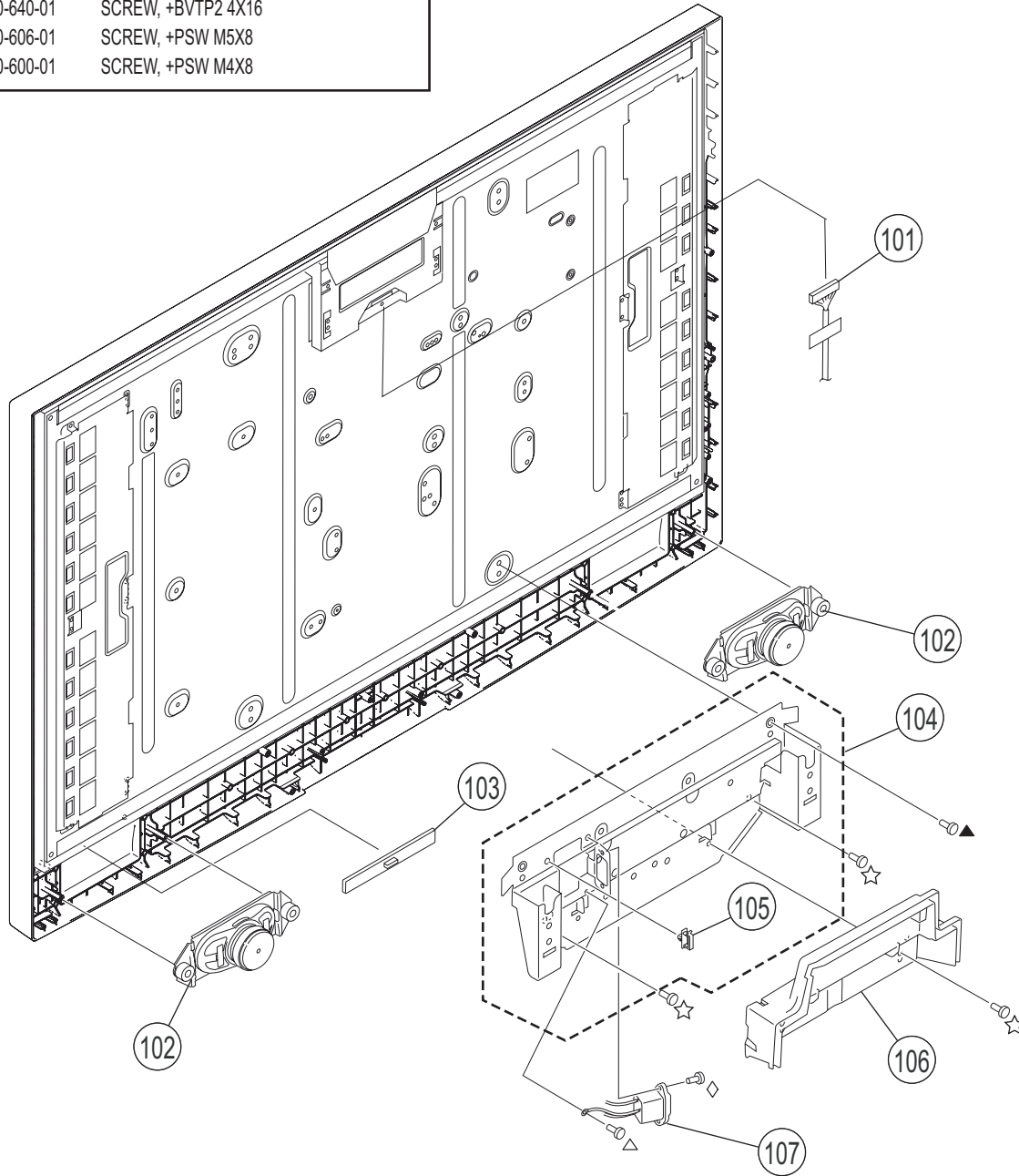

REF. NO.	PART NO.	DESCRIPTION	[ASSEMBLY INCLUDES]	REF. NO.	PART NO.	DESCRIPTION	[ASSEMBLY INCLUDES]
101	1-833-275-12	LEAD WIRE WITH CONNECTOR(LVDS) (KDL-40V2500 ONLY)		103	A-1196-572-A	H3U BOARD, MOUNTED	
101	1-833-276-12	LEAD WIRE WITH CONNECTOR(LVDS) (KDL-46V2500/46V25L1 ONLY)		104	X-2109-168-4	FRAME, BOTTOM (L) ASSY	
102	1-826-532-11	LOUDSPEAKER (5.5X15.5CM) (KDL-40V2500 ONLY)		105	2-650-770-21	SLIDE, CLAMP	
102	1-826-435-11	LOUDSPEAKER (13X7CM) (KDL-46V2500/46V25L1 ONLY)		106	2-660-801-02	COVER, UNDER (L) (KDL-40V2500/46V2500 ONLY)	
				106	2-890-853-01	COVER, UNDER (L) (KDL-46V25L1 ONLY)	
					107	1-819-729-14	INLET, AC (WITH NOISE FILTER)

NOTE: The components identified by shading and  mark are critical for safety. Replace only with part number specified.

NOTE: Les composants identifiés par un trame et une  sont critiques pour la sécurité. Ne les remplacer que par une pièce portant le numéro spécifié.

NOTE: The components identified by a red outline and a  mark contain confidential information. Specific instructions must be adhered to whenever these components are repaired and/or replaced.
See Appendix A: Encryption Key Components in the back of this manual.

4-4. LCD PANEL

- 7-685-648-79 SCREW +BVTP 3X12 TYPE2 IT-3
- ☆ 2-580-640-01 SCREW, +BVTP2 4X16

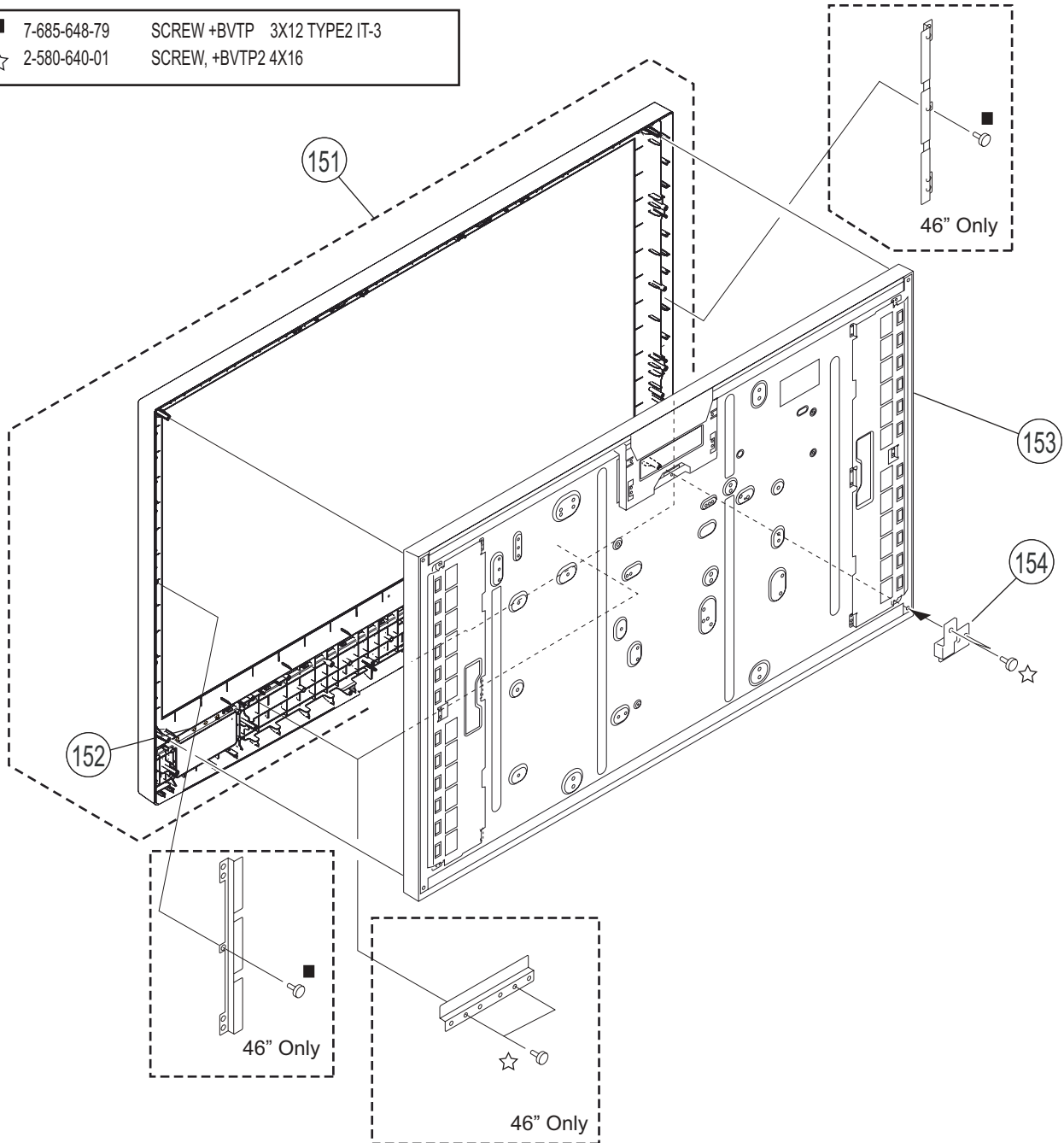

REF. NO.	PART NO.	DESCRIPTION	[ASSEMBLY INCLUDES]	REF. NO.	PART NO.	DESCRIPTION	[ASSEMBLY INCLUDES]
151	X-2148-136-1	BEZEL ASSY (40) (KDL-40V2500 ONLY)	[152]	* 152	2-664-630-01	GUIDE, LIGHT SENSOR	
151	X-2148-137-1	BEZEL ASSY (46) (KDL-46V2500 ONLY)	[152]	153	1-802-184-11	LCD PANEL (40INCH FHD TFT) (KDL-40V2500 ONLY)	
151	X-2159-788-1	BEZEL ASSY (46) (KDL-46V25L1 ONLY)	[152]	153	1-802-183-11	LCD PANEL (46INCH FHD TFT) (KDL-46V2500/46V25L1 ONLY)	
				* 154	2-682-132-01	BRACKET, PANEL CORNER (KDL-46V2500/46V25L1 ONLY)	



REF. NO.	PART NO.	DESCRIPTION	VALUES			REF. NO.	PART NO.	DESCRIPTION	VALUES		
C2550	1-162-966-11	CERAMIC CHIP	0.0022μF	10%	50V	C2617	1-112-800-11	ELECT CHIP	100μF	20%	35V
C2551	1-127-573-11	CERAMIC CHIP	1μF	10%	16V	C2618	1-100-912-11	CERAMIC CHIP	1μF	10%	25V
C2552	1-127-573-11	CERAMIC CHIP	1μF	10%	16V	C2619	1-100-912-11	CERAMIC CHIP	1μF	10%	25V
C2553	1-126-394-11	ELECT CHIP	10μF	20%	16V	C2620	1-100-912-11	CERAMIC CHIP	1μF	10%	25V
C2554	1-126-394-11	ELECT CHIP	10μF	20%	16V	C2621	1-100-912-11	CERAMIC CHIP	1μF	10%	25V
C2555	1-100-566-91	CERAMIC CHIP	0.1μF	10%	25V	C2623	1-165-818-91	CERAMIC CHIP	0.68μF	10%	25V
C2556	1-162-966-11	CERAMIC CHIP	0.0022μF	10%	50V	C2624	1-165-818-91	CERAMIC CHIP	0.68μF	10%	25V
C2557	1-126-396-11	ELECT CHIP	47μF	20%	16V	C2625	1-165-818-91	CERAMIC CHIP	0.68μF	10%	25V
C2560	1-112-692-11	CERAMIC CHIP	1000pF	5%	50V	C2626	1-165-818-91	CERAMIC CHIP	0.68μF	10%	25V
C2561	1-115-416-11	CERAMIC CHIP	0.001μF	5%	25V	C2627	1-100-591-91	CERAMIC CHIP	1μF	10%	25V
C2562	1-115-416-11	CERAMIC CHIP	0.001μF	5%	25V	C2628	1-100-591-91	CERAMIC CHIP	1μF	10%	25V
C2563	1-115-416-11	CERAMIC CHIP	0.001μF	5%	25V	C2647	1-100-591-91	CERAMIC CHIP	1μF	10%	25V
C2564	1-115-416-11	CERAMIC CHIP	0.001μF	5%	25V	C2648	1-107-826-11	CERAMIC CHIP	0.1μF	10%	16V
C2565	1-115-416-11	CERAMIC CHIP	0.001μF	5%	25V	C2800	1-124-779-00	ELECT CHIP	10μF	20%	16V
C2573	1-126-396-11	ELECT CHIP	47μF	20%	16V	C2801	1-107-826-11	CERAMIC CHIP	0.1μF	10%	16V
C2575	1-100-912-11	CERAMIC CHIP	1μF	10%	25V	C2802	1-107-826-11	CERAMIC CHIP	0.1μF	10%	16V
C2576	1-100-912-11	CERAMIC CHIP	1μF	10%	25V	C2803	1-127-573-11	CERAMIC CHIP	1μF	10%	16V
C2583	1-115-340-11	CERAMIC CHIP	0.22μF	10%	25V	C2804	1-127-573-11	CERAMIC CHIP	1μF	10%	16V
C2586	1-100-912-11	CERAMIC CHIP	1μF	10%	25V	C2805	1-126-204-11	ELECT CHIP	47μF	20%	16V
C2587	1-100-912-11	CERAMIC CHIP	1μF	10%	25V	C2809	1-126-394-11	ELECT CHIP	10μF	20%	16V
C2588	1-126-394-11	ELECT CHIP	10μF	20%	16V	C2810	1-107-826-11	CERAMIC CHIP	0.1μF	10%	16V
C2589	1-126-394-11	ELECT CHIP	10μF	20%	16V	C2811	1-124-779-00	ELECT CHIP	10μF	20%	16V
C2590	1-126-394-11	ELECT CHIP	10μF	20%	16V	C2812	1-107-826-11	CERAMIC CHIP	0.1μF	10%	16V
C2591	1-126-394-11	ELECT CHIP	10μF	20%	16V	C2813	1-124-779-00	ELECT CHIP	10μF	20%	16V
C2592	1-162-965-11	CERAMIC CHIP	0.0015μF	10%	50V	C2814	1-124-779-00	ELECT CHIP	10μF	20%	16V
C2593	1-164-217-11	CERAMIC CHIP	150pF	5%	50V	C2815	1-162-927-11	CERAMIC CHIP	100pF	5%	50V
C2594	1-164-217-11	CERAMIC CHIP	150pF	5%	50V	C2816	1-162-927-11	CERAMIC CHIP	100pF	5%	50V
C2595	1-162-965-11	CERAMIC CHIP	0.0015μF	10%	50V	C2817	1-126-396-11	ELECT CHIP	47μF	20%	16V
C2596	1-162-965-11	CERAMIC CHIP	0.0015μF	10%	50V	C2818	1-126-396-11	ELECT CHIP	47μF	20%	16V
C2597	1-164-217-11	CERAMIC CHIP	150pF	5%	50V	C2819	1-100-597-91	CERAMIC CHIP	0.1μF	10%	25V
C2598	1-164-217-11	CERAMIC CHIP	150pF	5%	50V	C2826	1-127-931-21	ELECT CHIP	470μF	20%	16V
C2599	1-162-965-11	CERAMIC CHIP	0.0015μF	10%	50V	C9005	1-127-573-11	CERAMIC CHIP	1μF	10%	16V
C2600	1-164-004-11	CERAMIC CHIP	0.1μF	10%	25V	C9006	1-127-573-11	CERAMIC CHIP	1μF	10%	16V
C2601	1-164-004-11	CERAMIC CHIP	0.1μF	10%	25V	C9007	1-127-573-11	CERAMIC CHIP	1μF	10%	16V
C2602	1-164-004-11	CERAMIC CHIP	0.1μF	10%	25V	C9008	1-127-573-11	CERAMIC CHIP	1μF	10%	16V
C2603	1-164-004-11	CERAMIC CHIP	0.1μF	10%	25V	C9014	1-127-573-11	CERAMIC CHIP	1μF	10%	16V
C2604	1-164-004-11	CERAMIC CHIP	0.1μF	10%	25V	C9015	1-127-573-11	CERAMIC CHIP	1μF	10%	16V
C2605	1-164-004-11	CERAMIC CHIP	0.1μF	10%	25V	C9016	1-125-891-11	CERAMIC CHIP	0.47μF	10%	10V
C2606	1-164-004-11	CERAMIC CHIP	0.1μF	10%	25V	C9019	1-125-889-91	CERAMIC CHIP	2.2μF	10%	10V
C2607	1-164-004-11	CERAMIC CHIP	0.1μF	10%	25V	C9020	1-125-889-91	CERAMIC CHIP	2.2μF	10%	10V
C2608	1-164-004-11	CERAMIC CHIP	0.1μF	10%	25V	C9021	1-125-889-91	CERAMIC CHIP	2.2μF	10%	10V
C2613	1-112-797-11	ELECT CHIP	470μF	20%	25V	C9022	1-125-889-91	CERAMIC CHIP	2.2μF	10%	10V
C2614	1-112-800-11	ELECT CHIP	100μF	20%	35V	C9023	1-127-573-11	CERAMIC CHIP	1μF	10%	16V
C2615	1-112-800-11	ELECT CHIP	100μF	20%	35V	C9024	1-127-573-11	CERAMIC CHIP	1μF	10%	16V
C2616	1-112-800-11	ELECT CHIP	100μF	20%	35V	C9032	1-115-416-11	CERAMIC CHIP	0.001μF	5%	25V



REF. NO.	PART NO.	DESCRIPTION	VALUES	REF. NO.	PART NO.	DESCRIPTION	VALUES
C9501	1-115-416-11	CERAMIC CHIP	0.001μF 5% 25V	D9017	8-719-423-03	DIODE	MA8100
C9502	1-115-416-11	CERAMIC CHIP	0.001μF 5% 25V	D9018	8-719-423-03	DIODE	MA8100
CONNECTOR				FERRITE BEAD			
CN2301	1-820-184-11	HEADER ASSEMBLY (PRINT PWB)		FB2500	1-400-089-21	FERRITE	0μH
CN2302	1-820-185-11	HEADER ASSEMBLY (PRINT PWB)		FB2501	1-400-089-21	FERRITE	0μH
CN2303	1-820-211-11	HEADER ASSEMBLY FOR PWB		FB2502	1-400-089-21	FERRITE	0μH
CN2500	1-819-461-11	HEADER ASSEMBLY FOR PWB		FB2503	1-400-089-21	FERRITE	0μH
CN9001	1-820-192-11	HEADER ASSEMBLY (PRINT PWB) 15P		FB2504	1-400-040-22	FERRITE	0μH
CN9501	1-819-390-51	FFC/FPC CONNECTOR (ZIF) 49P		FB2505	1-400-040-22	FERRITE	0μH
CN9502	1-820-186-11	HEADER ASSEMBLY (PRINT PWB)		FB2506	1-400-040-22	FERRITE	0μH
* CN9521	1-780-408-11	TERMINAL		FB2507	1-400-040-22	FERRITE	0μH
* CN9522	1-780-408-11	TERMINAL		FB2508	1-400-040-22	FERRITE	0μH
* CN9523	1-780-408-11	TERMINAL		FB9003	1-216-864-11	SHORT CHIP	
* CN9524	1-780-408-11	TERMINAL		IC			
* CN9525	1-780-408-11	TERMINAL		IC2001	8-752-089-33	IC	CXA2069Q-TL
* CN9526	1-780-408-11	TERMINAL		IC2501	6-709-040-11	IC	MAP4400A-QA-B2-501-T
DIODE				IC2503	8-759-278-58	IC	NJM4558V-TE2
D2101	8-719-058-24	DIODE	RB501V-40TE-17	IC2507	6-710-142-01	IC	R2A15105SP-W00T
D2501	8-719-423-17	DIODE	MA8110	IC2801	8-759-278-58	IC	NJM4558V-TE2
D2504	6-500-334-01	DIODE	MC2836-T112-1	IC2802	8-759-359-49	IC	NJM3414AV(TE2)
D2505	8-719-404-50	DIODE	MA111-TX	IC2803	6-709-927-01	IC	RT8H225C-TP-2
D2507	8-719-404-50	DIODE	MA111-TX	IC2804	6-709-927-01	IC	RT8H225C-TP-2
D2509	6-501-123-01	DIODE	RB160M-60TR	JACK			
D2510	6-501-123-01	DIODE	RB160M-60TR	J9001	1-780-271-11	S CONNECTOR BLOCK	
D2511	6-501-123-01	DIODE	RB160M-60TR	J9002	1-819-357-11	PHONO JACK	10P
D2512	6-501-123-01	DIODE	RB160M-60TR	J9003	1-780-373-11	TERMINAL BOARD	
D2513	8-719-404-50	DIODE	MA111-TX	COIL			
D2514	6-501-123-01	DIODE	RB160M-60TR	L2002	1-469-557-21	INDUCTOR	22μH
D2515	6-501-123-01	DIODE	RB160M-60TR	L2003	1-469-555-21	INDUCTOR	10μH
D2516	6-501-123-01	DIODE	RB160M-60TR	L2101	1-469-555-21	INDUCTOR	10μH
D2517	6-501-123-01	DIODE	RB160M-60TR	L2502	1-400-794-21	FERRITE	0μH
D2804	8-719-404-50	DIODE	MA111-TX	L2504	1-400-794-21	FERRITE	0μH
D2805	8-719-404-50	DIODE	MA111-TX	L2505	1-469-555-21	INDUCTOR	10μH
D9001	8-719-423-03	DIODE	MA8100	L2506	1-400-794-21	FERRITE	0μH
D9002	8-719-423-03	DIODE	MA8100	L2508	1-481-083-11	INDUCTOR	22μH
D9003	8-719-423-03	DIODE	MA8100	L2509	1-457-318-11	INDUCTOR	22μH
D9004	8-719-423-03	DIODE	MA8100	L2510	1-457-318-11	INDUCTOR	22μH
D9008	8-719-423-03	DIODE	MA8100	L2511	1-400-794-21	FERRITE	0μH
D9009	8-719-423-03	DIODE	MA8100	L2512	1-400-794-21	FERRITE	0μH
D9012	8-719-423-03	DIODE	MA8100	L2513	1-400-794-21	FERRITE	0μH
D9013	8-719-423-03	DIODE	MA8100	L9503	1-400-179-21	FERRITE	0μH
D9014	8-719-423-03	DIODE	MA8100	L9504	1-400-179-21	FERRITE	0μH
D9015	8-719-423-03	DIODE	MA8100	L9505	1-400-179-21	FERRITE	0μH
D9016	8-719-423-03	DIODE	MA8100				

NOTE: The components identified by shading and \triangle mark are critical for safety. Replace only with part number specified.

NOTE: Les composants identifiés par un triangle et une marque \triangle sont critiques pour la sécurité. Ne les remplacer que par une pièce portant le numéro spécifié.



REF. NO.	PART NO.	DESCRIPTION	VALUES			REF. NO.	PART NO.	DESCRIPTION	VALUES		
IC LINK											
\triangle PS2501	1-576-958-21	FUSE	4A	24V							
TRANSISTOR											
Q2001	8-729-120-28	TRANSISTOR	2SC1623-L5L6			R2015	1-216-864-11	SHORT CHIP			
Q2002	8-729-120-28	TRANSISTOR	2SC1623-L5L6			R2017	1-216-864-11	SHORT CHIP			
Q2101	8-729-600-22	TRANSISTOR	2SA1235-F			R2019	1-216-809-11	METAL CHIP	100	5%	1/10W
Q2102	8-729-600-22	TRANSISTOR	2SA1235-F			R2020	1-216-809-11	METAL CHIP	100	5%	1/10W
Q2104	8-729-600-22	TRANSISTOR	2SA1235-F			R2023	1-216-821-11	METAL CHIP	1K	5%	1/10W
Q2105	8-729-120-28	TRANSISTOR	2SC1623-L5L6			R2024	1-216-821-11	METAL CHIP	1K	5%	1/10W
Q2107	8-729-120-28	TRANSISTOR	2SC1623-L5L6			R2027	1-216-864-11	SHORT CHIP			
Q2108	8-729-120-28	TRANSISTOR	2SC1623-L5L6			R2028	1-216-864-11	SHORT CHIP			
Q2109	8-729-120-28	TRANSISTOR	2SC1623-L5L6			R2030	1-216-809-11	METAL CHIP	100	5%	1/10W
Q2111	8-729-120-28	TRANSISTOR	2SC1623-L5L6			R2033	1-216-864-11	SHORT CHIP			
Q2112	8-729-120-28	TRANSISTOR	2SC1623-L5L6			R2034	1-216-864-11	SHORT CHIP			
Q2113	8-729-600-22	TRANSISTOR	2SA1235-F			R2037	1-216-817-11	METAL CHIP	470	5%	1/10W
Q2502	8-729-120-28	TRANSISTOR	2SC1623-L5L6			R2038	1-216-817-11	METAL CHIP	470	5%	1/10W
Q2505	8-729-600-22	TRANSISTOR	2SA1235-F			R2039	1-216-864-11	SHORT CHIP			
Q2507	8-729-028-96	TRANSISTOR	DTC114EUA-T106			R2101	1-216-825-11	METAL CHIP	2.2K	5%	1/10W
Q2508	8-729-120-28	TRANSISTOR	2SC1623-L5L6			R2102	1-216-809-11	METAL CHIP	100	5%	1/10W
Q2510	8-729-029-14	TRANSISTOR	DTC144EUA-T106			R2103	1-216-864-11	SHORT CHIP			
Q2511	8-729-029-14	TRANSISTOR	DTC144EUA-T106			R2104	1-218-855-11	METAL CHIP	2.2K	0.50%	1/10W
Q2512	6-551-364-01	TRANSISTOR	DTC614TUT106			R2107	1-218-887-11	METAL CHIP	47K	0.50%	1/10W
Q2513	6-551-364-01	TRANSISTOR	DTC614TUT106			R2108	1-218-879-11	METAL CHIP	22K	0.50%	1/10W
Q2514	8-729-600-22	TRANSISTOR	2SA1235-F			R2109	1-216-829-11	METAL CHIP	4.7K	5%	1/10W
Q2515	8-729-600-22	TRANSISTOR	2SA1235-F			R2112	1-216-817-11	METAL CHIP	470	5%	1/10W
Q2516	8-729-600-22	TRANSISTOR	2SA1235-F			R2113	1-216-825-11	METAL CHIP	2.2K	5%	1/10W
Q2517	8-729-600-22	TRANSISTOR	2SA1235-F			R2114	1-218-889-11	METAL CHIP	56K	0.50%	1/10W
Q2518	8-729-120-28	TRANSISTOR	2SC1623-L5L6			R2117	1-216-857-11	METAL CHIP	1M	5%	1/10W
Q2519	8-729-029-14	TRANSISTOR	DTC144EUA-T106			R2120	1-218-871-11	METAL CHIP	10K	0.50%	1/10W
Q2520	8-729-029-14	TRANSISTOR	DTC144EUA-T106			R2121	1-216-829-11	METAL CHIP	4.7K	5%	1/10W
Q2521	8-729-028-96	TRANSISTOR	DTC114EUA-T106			R2123	1-216-821-11	METAL CHIP	1K	5%	1/10W
Q2803	6-551-364-01	TRANSISTOR	DTC614TUT106			R2125	1-218-857-11	METAL CHIP	2.7K	0.50%	1/10W
Q2804	6-551-364-01	TRANSISTOR	DTC614TUT106			R2126	1-216-821-11	METAL CHIP	1K	5%	1/10W
Q2806	6-551-364-01	TRANSISTOR	DTC614TUT106			R2128	1-218-861-11	METAL CHIP	3.9K	0.50%	1/10W
Q2807	6-551-364-01	TRANSISTOR	DTC614TUT106			R2129	1-218-861-11	METAL CHIP	3.9K	0.50%	1/10W
Q2815	8-729-602-21	TRANSISTOR	2SC4154TP-1G			R2130	1-216-829-11	METAL CHIP	4.7K	5%	1/10W
RESISTOR											
R2006	1-216-809-11	METAL CHIP	100	5%	1/10W	R2132	1-216-857-11	METAL CHIP	1M	5%	1/10W
R2007	1-216-809-11	METAL CHIP	100	5%	1/10W	R2133	1-216-829-11	METAL CHIP	4.7K	5%	1/10W
R2008	1-216-833-11	METAL CHIP	10K	5%	1/10W	R2134	1-216-864-11	SHORT CHIP			
R2009	1-216-839-11	METAL CHIP	33K	5%	1/10W	R2137	1-216-821-11	METAL CHIP	1K	5%	1/10W
R2014	1-216-864-11	SHORT CHIP				R2139	1-216-815-11	METAL CHIP	330	5%	1/10W
						R2140	1-216-864-11	SHORT CHIP			
						R2151	1-216-857-11	METAL CHIP	1M	5%	1/10W
						R2152	1-216-809-11	METAL CHIP	100	5%	1/10W
						R2301	1-414-445-11	FERRITE	0 μ H		
						R2303	1-216-864-11	SHORT CHIP			
						R2304	1-216-864-11	SHORT CHIP			
						R2504	1-216-864-11	SHORT CHIP			





REF. NO.	PART NO.	DESCRIPTION	VALUES			REF. NO.	PART NO.	DESCRIPTION	VALUES		
R2505	1-216-864-11	SHORT CHIP				R2617	1-216-833-11	METAL CHIP	10K	5%	1/10W
R2511	1-216-845-11	METAL CHIP	100K	5%	1/10W	R2620	1-216-864-11	SHORT CHIP			
R2512	1-218-990-81	SHORT CHIP				R2622	1-216-864-11	SHORT CHIP			
R2514	1-216-841-11	METAL CHIP	47K	5%	1/10W	R2624	1-218-867-11	METAL CHIP	6.8K	0.50%	1/10W
R2515	1-216-841-11	METAL CHIP	47K	5%	1/10W	R2625	1-218-867-11	METAL CHIP	6.8K	0.50%	1/10W
R2517	1-216-833-11	METAL CHIP	10K	5%	1/10W	R2626	1-218-875-11	METAL CHIP	15K	0.50%	1/10W
R2518	1-400-499-21	FERRITE	0μH			R2627	1-218-897-11	METAL CHIP	120K	0.50%	1/10W
R2519	1-400-499-21	FERRITE	0μH			R2628	1-218-885-11	METAL CHIP	39K	0.50%	1/10W
R2520	1-216-841-11	METAL CHIP	47K	5%	1/10W	R2629	1-218-875-11	METAL CHIP	15K	0.50%	1/10W
R2525	1-218-990-81	SHORT CHIP				R2630	1-218-867-11	METAL CHIP	6.8K	0.50%	1/10W
R2531	1-208-699-11	METAL CHIP	4.7K	0.50%	1/16W	R2631	1-218-867-11	METAL CHIP	6.8K	0.50%	1/10W
R2532	1-208-711-11	METAL CHIP	15K	0.50%	1/16W	R2632	1-218-897-11	METAL CHIP	120K	0.50%	1/10W
R2533	1-208-699-11	METAL CHIP	4.7K	0.50%	1/16W	R2633	1-218-897-11	METAL CHIP	120K	0.50%	1/10W
R2534	1-208-711-11	METAL CHIP	15K	0.50%	1/16W	R2636	1-216-296-11	SHORT CHIP			
R2535	1-208-935-11	METAL CHIP	100K	0.50%	1/16W	R2637	1-216-296-11	SHORT CHIP			
R2537	1-208-911-11	METAL CHIP	10K	0.50%	1/16W	R2642	1-216-845-11	METAL CHIP	100K	5%	1/10W
R2539	1-218-873-11	METAL CHIP	12K	0.50%	1/10W	R2643	1-216-845-11	METAL CHIP	100K	5%	1/10W
R2540	1-218-875-11	METAL CHIP	15K	0.50%	1/10W	R2644	1-216-845-11	METAL CHIP	100K	5%	1/10W
R2541	1-208-911-11	METAL CHIP	10K	0.50%	1/16W	R2645	1-216-845-11	METAL CHIP	100K	5%	1/10W
R2545	1-208-911-11	METAL CHIP	10K	0.50%	1/16W	R2646	1-216-845-11	METAL CHIP	100K	5%	1/10W
R2547	1-208-911-11	METAL CHIP	10K	0.50%	1/16W	R2647	1-216-845-11	METAL CHIP	100K	5%	1/10W
R2549	1-208-927-11	METAL CHIP	47K	0.50%	1/16W	R2652	1-216-833-11	METAL CHIP	10K	5%	1/10W
R2550	1-208-699-11	METAL CHIP	4.7K	0.50%	1/16W	R2653	1-216-845-11	METAL CHIP	100K	5%	1/10W
R2554	1-216-841-11	METAL CHIP	47K	5%	1/10W	R2654	1-216-845-11	METAL CHIP	100K	5%	1/10W
R2555	1-208-935-11	METAL CHIP	100K	0.50%	1/16W	R2655	1-216-864-11	SHORT CHIP			
R2556	1-208-699-11	METAL CHIP	4.7K	0.50%	1/16W	R2656	1-216-841-11	METAL CHIP	47K	5%	1/10W
R2557	1-208-711-11	METAL CHIP	15K	0.50%	1/16W	R2658	1-216-833-11	METAL CHIP	10K	5%	1/10W
R2559	1-208-711-11	METAL CHIP	15K	0.50%	1/16W	R2662	1-216-864-11	SHORT CHIP			
R2561	1-218-871-11	METAL CHIP	10K	0.50%	1/10W	R2663	1-216-864-11	SHORT CHIP			
R2562	1-218-869-11	METAL CHIP	8.2K	0.50%	1/10W	R2664	1-216-864-11	SHORT CHIP			
R2563	1-218-869-11	METAL CHIP	8.2K	0.50%	1/10W	R2665	1-216-864-11	SHORT CHIP			
R2564	1-218-871-11	METAL CHIP	10K	0.50%	1/10W	R2801	1-216-829-11	METAL CHIP	4.7K	5%	1/10W
R2566	1-218-867-11	METAL CHIP	6.8K	0.50%	1/10W	R2802	1-216-829-11	METAL CHIP	4.7K	5%	1/10W
R2567	1-216-833-11	METAL CHIP	10K	5%	1/10W	R2803	1-218-873-11	METAL CHIP	12K	0.50%	1/10W
R2587	1-216-857-11	METAL CHIP	1M	5%	1/10W	R2804	1-218-875-11	METAL CHIP	15K	0.50%	1/10W
R2588	1-216-837-11	METAL CHIP	22K	5%	1/10W	R2805	1-216-841-11	METAL CHIP	47K	5%	1/10W
R2593	1-216-841-11	METAL CHIP	47K	5%	1/10W	R2806	1-216-841-11	METAL CHIP	47K	5%	1/10W
R2601	1-216-845-11	METAL CHIP	100K	5%	1/10W	R2814	1-216-833-11	METAL CHIP	10K	5%	1/10W
R2603	1-218-865-11	METAL CHIP	5.6K	0.50%	1/10W	R2815	1-218-873-11	METAL CHIP	12K	0.50%	1/10W
R2611	1-216-841-11	METAL CHIP	47K	5%	1/10W	R2820	1-218-871-11	METAL CHIP	10K	0.50%	1/10W
R2612	1-216-864-11	SHORT CHIP				R2821	1-218-863-11	METAL CHIP	4.7K	0.50%	1/10W
R2613	1-218-887-11	METAL CHIP	47K	0.50%	1/10W	R2822	1-218-863-11	METAL CHIP	4.7K	0.50%	1/10W
R2614	1-218-855-11	METAL CHIP	2.2K	0.50%	1/10W	R2823	1-218-871-11	METAL CHIP	10K	0.50%	1/10W
R2615	1-218-887-11	METAL CHIP	47K	0.50%	1/10W	R2826	1-216-845-11	METAL CHIP	100K	5%	1/10W
R2616	1-218-855-11	METAL CHIP	2.2K	0.50%	1/10W	R2827	1-216-845-11	METAL CHIP	100K	5%	1/10W



REF. NO.	PART NO.	DESCRIPTION	VALUES			REF. NO.	PART NO.	DESCRIPTION	VALUES		
R2828	1-216-844-11	METAL CHIP	82K	5%	1/10W	R9020	1-216-853-11	METAL CHIP	470K	5%	1/10W
R2829	1-216-827-11	METAL CHIP	3.3K	5%	1/10W	R9021	1-216-853-11	METAL CHIP	470K	5%	1/10W
R2830	1-216-827-11	METAL CHIP	3.3K	5%	1/10W	R9022	1-216-853-11	METAL CHIP	470K	5%	1/10W
R2831	1-216-844-11	METAL CHIP	82K	5%	1/10W	R9023	1-216-864-11	SHORT CHIP			
R2832	1-218-887-11	METAL CHIP	47K	0.50%	1/10W	R9024	1-216-864-11	SHORT CHIP			
R2833	1-218-887-11	METAL CHIP	47K	0.50%	1/10W	R9025	1-218-831-11	METAL CHIP	220	0.50%	1/10W
R2834	1-218-855-11	METAL CHIP	2.2K	0.50%	1/10W	R9026	1-218-831-11	METAL CHIP	220	0.50%	1/10W
R2835	1-218-855-11	METAL CHIP	2.2K	0.50%	1/10W	R9027	1-218-831-11	METAL CHIP	220	0.50%	1/10W
R2837	1-216-857-11	METAL CHIP	1M	5%	1/10W	R9028	1-218-831-11	METAL CHIP	220	0.50%	1/10W
R2839	1-216-845-11	METAL CHIP	100K	5%	1/10W	R9029	1-218-831-11	METAL CHIP	220	0.50%	1/10W
R2840	1-216-864-11	SHORT CHIP				R9030	1-216-864-11	SHORT CHIP			
R2841	1-216-864-11	SHORT CHIP				R9031	1-216-864-11	SHORT CHIP			
R2843	1-216-845-11	METAL CHIP	100K	5%	1/10W	R9032	1-218-831-11	METAL CHIP	220	0.50%	1/10W
R2844	1-216-813-11	METAL CHIP	220	5%	1/10W	R9033	1-218-831-11	METAL CHIP	220	0.50%	1/10W
R2846	1-216-813-11	METAL CHIP	220	5%	1/10W	R9034	1-216-801-11	METAL CHIP	22	5%	1/10W
R2851	1-216-864-11	SHORT CHIP				R9035	1-218-831-11	METAL CHIP	220	0.50%	1/10W
R2852	1-216-864-11	SHORT CHIP				R9036	1-216-801-11	METAL CHIP	22	5%	1/10W
R2855	1-216-864-11	SHORT CHIP				R9037	1-216-801-11	METAL CHIP	22	5%	1/10W
R2856	1-216-864-11	SHORT CHIP				R9038	1-216-801-11	METAL CHIP	22	5%	1/10W
R2858	1-216-857-11	METAL CHIP	1M	5%	1/10W	R9039	1-218-285-11	METAL CHIP	75	5%	1/10W
R2859	1-216-833-11	METAL CHIP	10K	5%	1/10W	R9040	1-218-831-11	METAL CHIP	220	0.50%	1/10W
R2863	1-216-833-11	METAL CHIP	10K	5%	1/10W	R9041	1-218-831-11	METAL CHIP	220	0.50%	1/10W
R2872	1-216-821-11	METAL CHIP	1K	5%	1/10W	R9042	1-218-831-11	METAL CHIP	220	0.50%	1/10W
R2873	1-216-849-11	METAL CHIP	220K	5%	1/10W	R9043	1-216-801-11	METAL CHIP	22	5%	1/10W
R2876	1-216-864-11	SHORT CHIP				R9044	1-216-801-11	METAL CHIP	22	5%	1/10W
R2879	1-216-864-11	SHORT CHIP				R9045	1-216-864-11	SHORT CHIP			
R2882	1-216-864-11	SHORT CHIP				R9046	1-216-864-11	SHORT CHIP			
R2883	1-216-864-11	SHORT CHIP				R9057	1-216-809-11	METAL CHIP	100	5%	1/10W
R2884	1-216-864-11	SHORT CHIP				R9058	1-216-809-11	METAL CHIP	100	5%	1/10W
R9004	1-216-853-11	METAL CHIP	470K	5%	1/10W	R9059	1-216-821-11	METAL CHIP	1K	5%	1/10W
R9005	1-216-853-11	METAL CHIP	470K	5%	1/10W	R9060	1-216-821-11	METAL CHIP	1K	5%	1/10W
R9006	1-216-853-11	METAL CHIP	470K	5%	1/10W	R9061	1-216-809-11	METAL CHIP	100	5%	1/10W
R9007	1-216-853-11	METAL CHIP	470K	5%	1/10W	R9062	1-218-831-11	METAL CHIP	220	0.50%	1/10W
R9008	1-218-831-11	METAL CHIP	220	0.50%	1/10W	R9063	1-218-831-11	METAL CHIP	220	0.50%	1/10W
R9009	1-218-831-11	METAL CHIP	220	0.50%	1/10W	R9064	1-218-831-11	METAL CHIP	220	0.50%	1/10W
R9010	1-216-864-11	SHORT CHIP				R9065	1-218-831-11	METAL CHIP	220	0.50%	1/10W
R9011	1-216-864-11	SHORT CHIP				R9066	1-218-831-11	METAL CHIP	220	0.50%	1/10W
R9012	1-216-864-11	SHORT CHIP				R9067	1-218-831-11	METAL CHIP	220	0.50%	1/10W
R9013	1-216-864-11	SHORT CHIP				R9068	1-218-831-11	METAL CHIP	220	0.50%	1/10W
R9014	1-218-831-11	METAL CHIP	220	0.50%	1/10W	R9069	1-218-831-11	METAL CHIP	220	0.50%	1/10W
R9015	1-218-831-11	METAL CHIP	220	0.50%	1/10W	R9070	1-218-831-11	METAL CHIP	220	0.50%	1/10W
R9016	1-218-831-11	METAL CHIP	220	0.50%	1/10W	R9078	1-216-809-11	METAL CHIP	100	5%	1/10W
R9017	1-218-831-11	METAL CHIP	220	0.50%	1/10W	R9086	1-216-864-11	SHORT CHIP			
R9018	1-218-831-11	METAL CHIP	220	0.50%	1/10W	R9088	1-216-849-11	METAL CHIP	220K	5%	1/10W
R9019	1-216-853-11	METAL CHIP	470K	5%	1/10W	R9089	1-216-849-11	METAL CHIP	220K	5%	1/10W

NOTE: The components identified by a red outline and a  mark contain confidential information. Specific instructions must be adhered to whenever these components are repaired and/or replaced.
See Appendix A: Encryption Key Components in the back of this manual.



REF. NO.	PART NO.	DESCRIPTION	VALUES			REF. NO.	PART NO.	DESCRIPTION	VALUES		
R9095	1-216-821-11	METAL CHIP	1K	5%	1/10W	VD9004	8-719-423-03	DIODE	MA8100		
R9096	1-216-821-11	METAL CHIP	1K	5%	1/10W	VD9005	8-719-423-03	DIODE	MA8100		
R9097	1-216-821-11	METAL CHIP	1K	5%	1/10W	VD9006	8-719-423-03	DIODE	MA8100		
R9098	1-216-821-11	METAL CHIP	1K	5%	1/10W	VD9007	8-719-423-03	DIODE	MA8100		
R9099	1-216-821-11	METAL CHIP	1K	5%	1/10W	VD9008	8-719-423-03	DIODE	MA8100		
R9100	1-216-821-11	METAL CHIP	1K	5%	1/10W	VD9009	8-719-423-03	DIODE	MA8100		
R9101	1-216-821-11	METAL CHIP	1K	5%	1/10W	VD9010	8-719-423-03	DIODE	MA8100		
R9102	1-216-821-11	METAL CHIP	1K	5%	1/10W	VD9011	8-719-423-03	DIODE	MA8100		
R9150	1-216-864-11	SHORT CHIP				VD9012	8-719-423-03	DIODE	MA8100		
R9151	1-216-864-11	SHORT CHIP				VD9025	1-802-082-11	VARISTOR	(SMD)		
R9152	1-216-864-11	SHORT CHIP				VD9026	1-802-082-11	VARISTOR	(SMD)		
R9153	1-216-864-11	SHORT CHIP				VD9303	1-802-082-11	VARISTOR	(SMD)		
R9154	1-216-864-11	SHORT CHIP				VD9304	1-802-082-11	VARISTOR	(SMD)		
R9155	1-216-864-11	SHORT CHIP				VD9305	1-802-082-11	VARISTOR	(SMD)		
R9156	1-216-864-11	SHORT CHIP				CRYSTAL					
R9157	1-216-809-11	METAL CHIP	100	5%	1/10W	X2500	1-795-612-11	VIBRATOR, CRYSTAL			
R9158	1-216-809-11	METAL CHIP	100	5%	1/10W						
R9159	1-216-864-11	SHORT CHIP									
R9160	1-216-864-11	SHORT CHIP									
R9161	1-216-864-11	SHORT CHIP									
R9333	1-216-864-11	SHORT CHIP									
R9334	1-216-864-11	SHORT CHIP									
R9501	1-216-864-11	SHORT CHIP				 A-1196-624-A BU BOARD, MOUNTED (SERVICE) (KDL-40V2500 ONLY)					
R9502	1-216-864-11	SHORT CHIP									
R9506	1-218-885-11	METAL CHIP	39K	0.50%	1/10W	CAPACITOR					
R9515	1-216-864-11	SHORT CHIP				C4003	1-162-964-11	CERAMIC CHIP	0.001µF	10%	50V
R9516	1-216-864-11	SHORT CHIP				C4004	1-162-970-11	CERAMIC CHIP	0.01µF	10%	25V
R9517	1-216-864-11	SHORT CHIP				C4006	1-100-906-11	CERAMIC CHIP	0.01µF	10%	16V
R9518	1-216-864-11	SHORT CHIP				C4007	1-162-964-11	CERAMIC CHIP	0.001µF	10%	50V
R9519	1-216-864-11	SHORT CHIP				C4010	1-100-916-11	CERAMIC CHIP	0.1µF	10%	16V
R9520	1-216-864-11	SHORT CHIP				C4011	1-126-206-11	ELECT CHIP	100µF	20%	6.3V
R9521	1-216-864-11	SHORT CHIP				C4012	1-100-591-91	CERAMIC CHIP	1µF	10%	25V
R9522	1-216-864-11	SHORT CHIP				C4013	1-112-777-11	CERAMIC CHIP	0.01µF	10%	25V
R9523	1-216-864-11	SHORT CHIP				C4014	1-112-777-11	CERAMIC CHIP	0.01µF	10%	25V
R9524	1-216-864-11	SHORT CHIP				C4015	1-100-906-11	CERAMIC CHIP	0.01µF	10%	16V
R9525	1-216-864-11	SHORT CHIP				C4016	1-100-916-11	CERAMIC CHIP	0.1µF	10%	16V
R9526	1-216-864-11	SHORT CHIP				C4017	1-100-906-11	CERAMIC CHIP	0.01µF	10%	16V
R9527	1-216-864-11	SHORT CHIP				C4018	1-100-916-11	CERAMIC CHIP	0.1µF	10%	16V
R9528	1-216-864-11	SHORT CHIP				C4019	1-164-847-11	CERAMIC CHIP	7pF	0.50pF	50V
R9529	1-216-864-11	SHORT CHIP				C4021	1-100-906-11	CERAMIC CHIP	0.01µF	10%	16V
R9530	1-216-864-11	SHORT CHIP				C4022	1-126-392-11	ELECT CHIP	100µF	20%	6.3V
VARISTOR						C4023	1-100-916-11	CERAMIC CHIP	0.1µF	10%	16V
VD9001	8-719-423-03	DIODE				C4024	1-126-392-11	ELECT CHIP	100µF	20%	6.3V
VD9002	8-719-423-03	DIODE				C4025	1-100-916-11	CERAMIC CHIP	0.1µF	10%	16V
VD9003	8-719-423-03	DIODE				C4026	1-100-906-11	CERAMIC CHIP	0.01µF	10%	16V
						C4027	1-100-916-11	CERAMIC CHIP	0.1µF	10%	16V
						C4028	1-100-916-11	CERAMIC CHIP	0.1µF	10%	16V



REF. NO.	PART NO.	DESCRIPTION	VALUES			REF. NO.	PART NO.	DESCRIPTION	VALUES		
C4029	1-100-906-11	CERAMIC CHIP	0.01μF	10%	16V	C4076	1-112-781-11	CERAMIC CHIP	1μF	10%	10V
C4030	1-112-777-11	CERAMIC CHIP	0.01μF	10%	25V	C4079	1-100-916-11	CERAMIC CHIP	0.1μF	10%	16V
C4031	1-100-916-11	CERAMIC CHIP	0.1μF	10%	16V	C4080	1-100-906-11	CERAMIC CHIP	0.01μF	10%	16V
C4032	1-100-906-11	CERAMIC CHIP	0.01μF	10%	16V	C4081	1-126-391-11	ELECT CHIP	47μF	20%	6.3V
C4033	1-100-916-11	CERAMIC CHIP	0.1μF	10%	16V	C4082	1-126-394-11	ELECT CHIP	10μF	20%	16V
C4034	1-100-906-11	CERAMIC CHIP	0.01μF	10%	16V	C4083	1-100-916-11	CERAMIC CHIP	0.1μF	10%	16V
C4035	1-100-906-11	CERAMIC CHIP	0.01μF	10%	16V	C4084	1-100-905-11	CERAMIC CHIP	0.001μF	10%	50V
C4036	1-112-064-11	CERAMIC CHIP	2.2μF	10%	10V	C4086	1-112-777-11	CERAMIC CHIP	0.01μF	10%	25V
C4037	1-100-906-11	CERAMIC CHIP	0.01μF	10%	16V	C4087	1-100-916-11	CERAMIC CHIP	0.1μF	10%	16V
C4038	1-100-916-11	CERAMIC CHIP	0.1μF	10%	16V	C4089	1-100-905-11	CERAMIC CHIP	0.001μF	10%	50V
C4039	1-100-906-11	CERAMIC CHIP	0.01μF	10%	16V	C4090	1-100-916-11	CERAMIC CHIP	0.1μF	10%	16V
C4040	1-100-916-11	CERAMIC CHIP	0.1μF	10%	16V	C4091	1-100-912-11	CERAMIC CHIP	1μF	10%	25V
C4041	1-100-916-11	CERAMIC CHIP	0.1μF	10%	16V	C4092	1-100-566-91	CERAMIC CHIP	0.1μF	10%	25V
C4042	1-100-906-11	CERAMIC CHIP	0.01μF	10%	16V	C4100	1-100-911-11	CERAMIC CHIP	4.7μF	10%	25V
C4043	1-100-906-11	CERAMIC CHIP	0.01μF	10%	16V	C4101	1-100-911-11	CERAMIC CHIP	4.7μF	10%	25V
C4044	1-100-591-91	CERAMIC CHIP	1μF	10%	25V	C4105	1-164-874-11	CERAMIC CHIP	100pF	5%	50V
C4045	1-100-916-11	CERAMIC CHIP	0.1μF	10%	16V	C4106	1-164-874-11	CERAMIC CHIP	100pF	5%	50V
C4046	1-100-906-11	CERAMIC CHIP	0.01μF	10%	16V	C4107	1-164-874-11	CERAMIC CHIP	100pF	5%	50V
C4047	1-100-916-11	CERAMIC CHIP	0.1μF	10%	16V	C4110	1-100-916-11	CERAMIC CHIP	0.1μF	10%	16V
C4048	1-100-916-11	CERAMIC CHIP	0.1μF	10%	16V	C4301	1-112-692-11	CERAMIC CHIP	1000pF	5%	50V
C4049	1-100-906-11	CERAMIC CHIP	0.01μF	10%	16V	C4402	1-100-916-11	CERAMIC CHIP	0.1μF	10%	16V
C4050	1-100-916-11	CERAMIC CHIP	0.1μF	10%	16V	C4403	1-127-573-11	CERAMIC CHIP	1μF	10%	16V
C4051	1-126-394-11	ELECT CHIP	10μF	20%	16V	C4404	1-127-573-11	CERAMIC CHIP	1μF	10%	16V
C4052	1-100-916-11	CERAMIC CHIP	0.1μF	10%	16V	C4405	1-162-927-11	CERAMIC CHIP	100pF	5%	50V
C4053	1-126-394-11	ELECT CHIP	10μF	20%	16V	C4406	1-162-927-11	CERAMIC CHIP	100pF	5%	50V
C4054	1-100-916-11	CERAMIC CHIP	0.1μF	10%	16V	C4407	1-164-874-11	CERAMIC CHIP	100pF	5%	50V
C4055	1-100-916-11	CERAMIC CHIP	0.1μF	10%	16V	C4408	1-112-781-11	CERAMIC CHIP	1μF	10%	10V
C4056	1-100-916-11	CERAMIC CHIP	0.1μF	10%	16V	C4409	1-100-906-11	CERAMIC CHIP	0.01μF	10%	16V
C4057	1-100-916-11	CERAMIC CHIP	0.1μF	10%	16V	C4412	1-100-566-91	CERAMIC CHIP	0.1μF	10%	25V
C4058	1-100-916-11	CERAMIC CHIP	0.1μF	10%	16V	C4413	1-127-573-11	CERAMIC CHIP	1μF	10%	16V
C4059	1-100-906-11	CERAMIC CHIP	0.01μF	10%	16V	C4414	1-127-573-11	CERAMIC CHIP	1μF	10%	16V
C4060	1-100-906-11	CERAMIC CHIP	0.01μF	10%	16V	C4415	1-100-905-11	CERAMIC CHIP	0.001μF	10%	50V
C4061	1-100-906-11	CERAMIC CHIP	0.01μF	10%	16V	C4416	1-164-874-11	CERAMIC CHIP	100pF	5%	50V
C4062	1-126-394-11	ELECT CHIP	10μF	20%	16V	C4511	1-164-937-11	CERAMIC CHIP	0.001μF	10%	50V
C4063	1-100-916-11	CERAMIC CHIP	0.1μF	10%	16V	C4700	1-117-681-11	ELECT CHIP	100μF	20%	16V
C4066	1-100-916-11	CERAMIC CHIP	0.1μF	10%	16V	C4701	1-112-777-11	CERAMIC CHIP	0.01μF	10%	25V
C4067	1-100-566-91	CERAMIC CHIP	0.1μF	10%	25V	C4702	1-164-874-11	CERAMIC CHIP	100pF	5%	50V
C4068	1-100-566-91	CERAMIC CHIP	0.1μF	10%	25V	C5000	1-100-916-11	CERAMIC CHIP	0.1μF	10%	16V
C4069	1-100-566-91	CERAMIC CHIP	0.1μF	10%	25V	C5002	1-100-908-11	CERAMIC CHIP	1μF	10%	6.3V
C4070	1-100-906-11	CERAMIC CHIP	0.01μF	10%	16V	C5003	1-100-916-11	CERAMIC CHIP	0.1μF	10%	16V
C4071	1-164-874-11	CERAMIC CHIP	100pF	5%	50V	C5004	1-100-916-11	CERAMIC CHIP	0.1μF	10%	16V
C4072	1-100-916-11	CERAMIC CHIP	0.1μF	10%	16V	C5005	1-100-916-11	CERAMIC CHIP	0.1μF	10%	16V
C4073	1-126-390-11	ELECT CHIP	22μF	20%	6.3V	C5006	1-164-847-11	CERAMIC CHIP	7pF	0.50pF	50V
C4074	1-100-916-11	CERAMIC CHIP	0.1μF	10%	16V	C5007	1-164-847-11	CERAMIC CHIP	7pF	0.50pF	50V
C4075	1-164-939-11	CERAMIC CHIP	0.0022μF	10%	50V	C5008	1-112-774-11	CERAMIC CHIP	470pF	10%	50V



REF. NO.	PART NO.	DESCRIPTION	VALUES			REF. NO.	PART NO.	DESCRIPTION	VALUES		
C5009	1-112-777-11	CERAMIC CHIP	0.01μF	10%	25V	C5314	1-100-905-11	CERAMIC CHIP	0.001μF	10%	50V
C5011	1-100-905-11	CERAMIC CHIP	0.001μF	10%	50V	C5315	1-100-916-11	CERAMIC CHIP	0.1μF	10%	16V
C5012	1-112-777-11	CERAMIC CHIP	0.01μF	10%	25V	C5316	1-126-392-11	ELECT CHIP	100μF	20%	6.3V
C5013	1-112-777-11	CERAMIC CHIP	0.01μF	10%	25V	C5317	1-100-916-11	CERAMIC CHIP	0.1μF	10%	16V
C5014	1-100-905-11	CERAMIC CHIP	0.001μF	10%	50V	C5318	1-100-916-11	CERAMIC CHIP	0.1μF	10%	16V
C5036	1-100-905-11	CERAMIC CHIP	0.001μF	10%	50V	C5319	1-100-905-11	CERAMIC CHIP	0.001μF	10%	50V
C5038	1-100-905-11	CERAMIC CHIP	0.001μF	10%	50V	C5320	1-126-392-11	ELECT CHIP	100μF	20%	6.3V
C5201	1-100-916-11	CERAMIC CHIP	0.1μF	10%	16V	C5321	1-112-068-11	CERAMIC CHIP	220pF	10%	50V
C5203	1-100-916-11	CERAMIC CHIP	0.1μF	10%	16V	C5322	1-100-916-11	CERAMIC CHIP	0.1μF	10%	16V
C5205	1-100-916-11	CERAMIC CHIP	0.1μF	10%	16V	C5323	1-100-906-11	CERAMIC CHIP	0.01μF	10%	16V
C5207	1-100-916-11	CERAMIC CHIP	0.1μF	10%	16V	C5324	1-162-979-11	CERAMIC CHIP	0.0027μF	10%	50V
C5208	1-115-340-11	CERAMIC CHIP	0.22μF	10%	25V	C5325	1-162-979-11	CERAMIC CHIP	0.0027μF	10%	50V
C5209	1-117-681-11	ELECT CHIP	100μF	20%	16V	C5326	1-100-916-11	CERAMIC CHIP	0.1μF	10%	16V
C5210	1-100-566-91	CERAMIC CHIP	0.1μF	10%	25V	C5327	1-100-916-11	CERAMIC CHIP	0.1μF	10%	16V
C5211	1-100-566-91	CERAMIC CHIP	0.1μF	10%	25V	C5328	1-100-905-11	CERAMIC CHIP	0.001μF	10%	50V
C5212	1-100-916-11	CERAMIC CHIP	0.1μF	10%	16V	C5329	1-100-905-11	CERAMIC CHIP	0.001μF	10%	50V
C5214	1-100-916-11	CERAMIC CHIP	0.1μF	10%	16V	C5330	1-100-916-11	CERAMIC CHIP	0.1μF	10%	16V
C5215	1-100-916-11	CERAMIC CHIP	0.1μF	10%	16V	C5331	1-100-916-11	CERAMIC CHIP	0.1μF	10%	16V
C5216	1-100-916-11	CERAMIC CHIP	0.1μF	10%	16V	C5332	1-100-916-11	CERAMIC CHIP	0.1μF	10%	16V
C5217	1-100-916-11	CERAMIC CHIP	0.1μF	10%	16V	C5333	1-100-905-11	CERAMIC CHIP	0.001μF	10%	50V
C5218	1-100-916-11	CERAMIC CHIP	0.1μF	10%	16V	C5334	1-164-874-11	CERAMIC CHIP	100pF	5%	50V
C5219	1-100-916-11	CERAMIC CHIP	0.1μF	10%	16V	C5335	1-100-916-11	CERAMIC CHIP	0.1μF	10%	16V
C5220	1-100-916-11	CERAMIC CHIP	0.1μF	10%	16V	C5336	1-100-905-11	CERAMIC CHIP	0.001μF	10%	50V
C5221	1-100-916-11	CERAMIC CHIP	0.1μF	10%	16V	C5337	1-100-916-11	CERAMIC CHIP	0.1μF	10%	16V
C5222	1-100-916-11	CERAMIC CHIP	0.1μF	10%	16V	C5338	1-100-905-11	CERAMIC CHIP	0.001μF	10%	50V
C5223	1-100-916-11	CERAMIC CHIP	0.1μF	10%	16V	C5339	1-100-916-11	CERAMIC CHIP	0.1μF	10%	16V
C5224	1-100-916-11	CERAMIC CHIP	0.1μF	10%	16V	C5340	1-100-916-11	CERAMIC CHIP	0.1μF	10%	16V
C5226	1-100-916-11	CERAMIC CHIP	0.1μF	10%	16V	C5341	1-100-905-11	CERAMIC CHIP	0.001μF	10%	50V
C5227	1-100-916-11	CERAMIC CHIP	0.1μF	10%	16V	C5342	1-100-916-11	CERAMIC CHIP	0.1μF	10%	16V
C5228	1-100-916-11	CERAMIC CHIP	0.1μF	10%	16V	C5343	1-100-905-11	CERAMIC CHIP	0.001μF	10%	50V
C5229	1-100-916-11	CERAMIC CHIP	0.1μF	10%	16V	C5344	1-100-916-11	CERAMIC CHIP	0.1μF	10%	16V
C5300	1-126-394-11	ELECT CHIP	10μF	20%	16V	C5345	1-100-905-11	CERAMIC CHIP	0.001μF	10%	50V
C5301	1-126-394-11	ELECT CHIP	10μF	20%	16V	C5346	1-100-916-11	CERAMIC CHIP	0.1μF	10%	16V
C5302	1-126-392-11	ELECT CHIP	100μF	20%	6.3V	C5347	1-100-905-11	CERAMIC CHIP	0.001μF	10%	50V
C5303	1-126-394-11	ELECT CHIP	10μF	20%	16V	C5348	1-100-916-11	CERAMIC CHIP	0.1μF	10%	16V
C5304	1-100-916-11	CERAMIC CHIP	0.1μF	10%	16V	C5349	1-100-905-11	CERAMIC CHIP	0.001μF	10%	50V
C5305	1-100-916-11	CERAMIC CHIP	0.1μF	10%	16V	C5350	1-100-916-11	CERAMIC CHIP	0.1μF	10%	16V
C5306	1-100-916-11	CERAMIC CHIP	0.1μF	10%	16V	C5351	1-100-905-11	CERAMIC CHIP	0.001μF	10%	50V
C5307	1-100-916-11	CERAMIC CHIP	0.1μF	10%	16V	C5352	1-164-874-11	CERAMIC CHIP	100pF	5%	50V
C5308	1-100-916-11	CERAMIC CHIP	0.1μF	10%	16V	C5353	1-100-916-11	CERAMIC CHIP	0.1μF	10%	16V
C5309	1-100-916-11	CERAMIC CHIP	0.1μF	10%	16V	C5354	1-100-905-11	CERAMIC CHIP	0.001μF	10%	50V
C5310	1-100-916-11	CERAMIC CHIP	0.1μF	10%	16V	C5355	1-100-916-11	CERAMIC CHIP	0.1μF	10%	16V
C5311	1-100-916-11	CERAMIC CHIP	0.1μF	10%	16V	C5356	1-100-905-11	CERAMIC CHIP	0.001μF	10%	50V
C5312	1-126-392-11	ELECT CHIP	100μF	20%	6.3V	C5357	1-164-874-11	CERAMIC CHIP	100pF	5%	50V
C5313	1-100-916-11	CERAMIC CHIP	0.1μF	10%	16V	C5358	1-100-916-11	CERAMIC CHIP	0.1μF	10%	16V



REF. NO.	PART NO.	DESCRIPTION	VALUES			REF. NO.	PART NO.	DESCRIPTION	VALUES		
C5449	1-100-905-11	CERAMIC CHIP	0.001μF	10%	50V	C5527	1-100-905-11	CERAMIC CHIP	0.001μF	10%	50V
C5450	1-100-916-11	CERAMIC CHIP	0.1μF	10%	16V	C5528	1-100-916-11	CERAMIC CHIP	0.1μF	10%	16V
C5451	1-100-905-11	CERAMIC CHIP	0.001μF	10%	50V	C5529	1-100-905-11	CERAMIC CHIP	0.001μF	10%	50V
C5452	1-164-874-11	CERAMIC CHIP	100pF	5%	50V	C5530	1-100-916-11	CERAMIC CHIP	0.1μF	10%	16V
C5453	1-100-916-11	CERAMIC CHIP	0.1μF	10%	16V	C5531	1-100-905-11	CERAMIC CHIP	0.001μF	10%	50V
C5454	1-100-905-11	CERAMIC CHIP	0.001μF	10%	50V	C5532	1-100-916-11	CERAMIC CHIP	0.1μF	10%	16V
C5455	1-100-905-11	CERAMIC CHIP	0.001μF	10%	50V	C5533	1-100-916-11	CERAMIC CHIP	0.1μF	10%	16V
C5456	1-100-905-11	CERAMIC CHIP	0.001μF	10%	50V	C5534	1-100-916-11	CERAMIC CHIP	0.1μF	10%	16V
C5457	1-100-916-11	CERAMIC CHIP	0.1μF	10%	16V	C5535	1-100-916-11	CERAMIC CHIP	0.1μF	10%	16V
C5458	1-100-905-11	CERAMIC CHIP	0.001μF	10%	50V	C5536	1-100-916-11	CERAMIC CHIP	0.1μF	10%	16V
C5459	1-100-916-11	CERAMIC CHIP	0.1μF	10%	16V	C5537	1-100-916-11	CERAMIC CHIP	0.1μF	10%	16V
C5460	1-100-905-11	CERAMIC CHIP	0.001μF	10%	50V	C5538	1-100-916-11	CERAMIC CHIP	0.1μF	10%	16V
C5461	1-100-916-11	CERAMIC CHIP	0.1μF	10%	16V	C5539	1-100-916-11	CERAMIC CHIP	0.1μF	10%	16V
C5462	1-100-905-11	CERAMIC CHIP	0.001μF	10%	50V	C5540	1-100-905-11	CERAMIC CHIP	0.001μF	10%	50V
C5463	1-100-916-11	CERAMIC CHIP	0.1μF	10%	16V	C5541	1-100-905-11	CERAMIC CHIP	0.001μF	10%	50V
C5464	1-100-905-11	CERAMIC CHIP	0.001μF	10%	50V	C5542	1-100-905-11	CERAMIC CHIP	0.001μF	10%	50V
C5465	1-100-905-11	CERAMIC CHIP	0.001μF	10%	50V	C5543	1-100-905-11	CERAMIC CHIP	0.001μF	10%	50V
C5466	1-100-916-11	CERAMIC CHIP	0.1μF	10%	16V	C5544	1-100-905-11	CERAMIC CHIP	0.001μF	10%	50V
C5467	1-100-906-11	CERAMIC CHIP	0.01μF	10%	16V	C5545	1-100-905-11	CERAMIC CHIP	0.001μF	10%	50V
C5500	1-100-916-11	CERAMIC CHIP	0.1μF	10%	16V	C5546	1-100-905-11	CERAMIC CHIP	0.001μF	10%	50V
C5501	1-100-916-11	CERAMIC CHIP	0.1μF	10%	16V	C5547	1-100-905-11	CERAMIC CHIP	0.001μF	10%	50V
C5502	1-100-916-11	CERAMIC CHIP	0.1μF	10%	16V	C5548	1-100-906-11	CERAMIC CHIP	0.01μF	10%	16V
C5503	1-100-916-11	CERAMIC CHIP	0.1μF	10%	16V	C5549	1-100-916-11	CERAMIC CHIP	0.1μF	10%	16V
C5504	1-100-916-11	CERAMIC CHIP	0.1μF	10%	16V	C5550	1-100-916-11	CERAMIC CHIP	0.1μF	10%	16V
C5505	1-100-916-11	CERAMIC CHIP	0.1μF	10%	16V	C5551	1-100-916-11	CERAMIC CHIP	0.1μF	10%	16V
C5506	1-100-916-11	CERAMIC CHIP	0.1μF	10%	16V	C5552	1-100-905-11	CERAMIC CHIP	0.001μF	10%	50V
C5507	1-100-916-11	CERAMIC CHIP	0.1μF	10%	16V	C5553	1-100-916-11	CERAMIC CHIP	0.1μF	10%	16V
C5508	1-100-905-11	CERAMIC CHIP	0.001μF	10%	50V	C5554	1-100-905-11	CERAMIC CHIP	0.001μF	10%	50V
C5509	1-100-905-11	CERAMIC CHIP	0.001μF	10%	50V	C5555	1-100-916-11	CERAMIC CHIP	0.1μF	10%	16V
C5510	1-100-905-11	CERAMIC CHIP	0.001μF	10%	50V	C5556	1-100-905-11	CERAMIC CHIP	0.001μF	10%	50V
C5511	1-100-905-11	CERAMIC CHIP	0.001μF	10%	50V	C5557	1-100-916-11	CERAMIC CHIP	0.1μF	10%	16V
C5512	1-100-905-11	CERAMIC CHIP	0.001μF	10%	50V	C5558	1-100-905-11	CERAMIC CHIP	0.001μF	10%	50V
C5513	1-100-905-11	CERAMIC CHIP	0.001μF	10%	50V	C5559	1-100-916-11	CERAMIC CHIP	0.1μF	10%	16V
C5514	1-100-905-11	CERAMIC CHIP	0.001μF	10%	50V	C5560	1-100-905-11	CERAMIC CHIP	0.001μF	10%	50V
C5515	1-100-905-11	CERAMIC CHIP	0.001μF	10%	50V	C5561	1-100-916-11	CERAMIC CHIP	0.1μF	10%	16V
C5516	1-100-906-11	CERAMIC CHIP	0.01μF	10%	16V	C5562	1-100-916-11	CERAMIC CHIP	0.1μF	10%	16V
C5518	1-100-905-11	CERAMIC CHIP	0.001μF	10%	50V	C5802	1-124-779-00	ELECT CHIP	10μF	20%	16V
C5519	1-100-916-11	CERAMIC CHIP	0.1μF	10%	16V	C5803	1-100-905-11	CERAMIC CHIP	0.001μF	10%	50V
C5520	1-100-905-11	CERAMIC CHIP	0.001μF	10%	50V	C5807	1-127-573-11	CERAMIC CHIP	1μF	10%	16V
C5521	1-100-905-11	CERAMIC CHIP	0.001μF	10%	50V	C5808	1-127-573-11	CERAMIC CHIP	1μF	10%	16V
C5522	1-126-392-11	ELECT CHIP	100μF	20%	6.3V	C5809	1-126-392-11	ELECT CHIP	100μF	20%	6.3V
C5523	1-126-392-11	ELECT CHIP	100μF	20%	6.3V	C5811	1-100-906-11	CERAMIC CHIP	0.01μF	10%	16V
C5524	1-100-916-11	CERAMIC CHIP	0.1μF	10%	16V	C5812	1-100-906-11	CERAMIC CHIP	0.01μF	10%	16V
C5525	1-100-905-11	CERAMIC CHIP	0.001μF	10%	50V	C5813	1-126-390-11	ELECT CHIP	22μF	20%	6.3V
C5526	1-100-916-11	CERAMIC CHIP	0.1μF	10%	16V	C5814	1-124-779-00	ELECT CHIP	10μF	20%	16V



REF. NO.	PART NO.	DESCRIPTION	VALUES			REF. NO.	PART NO.	DESCRIPTION	VALUES		
C5818	1-164-874-11	CERAMIC CHIP	100pF	5%	50V	C5870	1-100-905-11	CERAMIC CHIP	0.001μF	10%	50V
C5819	1-100-916-11	CERAMIC CHIP	0.1μF	10%	16V	C5871	1-164-854-11	CERAMIC CHIP	15pF	5%	50V
C5820	1-164-874-11	CERAMIC CHIP	100pF	5%	50V	C5872	1-100-905-11	CERAMIC CHIP	0.001μF	10%	50V
C5821	1-164-874-11	CERAMIC CHIP	100pF	5%	50V	C5873	1-164-852-11	CERAMIC CHIP	12pF	5%	50V
C5827	1-126-394-11	ELECT CHIP	10μF	20%	16V	C5874	1-100-905-11	CERAMIC CHIP	0.001μF	10%	50V
C5828	1-164-874-11	CERAMIC CHIP	100pF	5%	50V	C5875	1-100-905-11	CERAMIC CHIP	0.001μF	10%	50V
C5829	1-100-905-11	CERAMIC CHIP	0.001μF	10%	50V	C5876	1-100-916-11	CERAMIC CHIP	0.1μF	10%	16V
C5832	1-100-916-11	CERAMIC CHIP	0.1μF	10%	16V	C5877	1-100-916-11	CERAMIC CHIP	0.1μF	10%	16V
C5833	1-100-566-91	CERAMIC CHIP	0.1μF	10%	25V	C5878	1-100-916-11	CERAMIC CHIP	0.1μF	10%	16V
C5834	1-126-396-11	ELECT CHIP	47μF	20%	16V	C5879	1-126-394-11	ELECT CHIP	10μF	20%	16V
C5835	1-127-573-11	CERAMIC CHIP	1μF	10%	16V	C5880	1-126-394-11	ELECT CHIP	10μF	20%	16V
C5836	1-127-573-11	CERAMIC CHIP	1μF	10%	16V	C5881	1-100-905-11	CERAMIC CHIP	0.001μF	10%	50V
C5837	1-112-064-11	CERAMIC CHIP	2.2μF	10%	10V	C5882	1-100-905-11	CERAMIC CHIP	0.001μF	10%	50V
C5838	1-112-064-11	CERAMIC CHIP	2.2μF	10%	10V	C5883	1-100-905-11	CERAMIC CHIP	0.001μF	10%	50V
C5839	1-164-936-11	CERAMIC CHIP	680pF	10%	50V	C5884	1-100-905-11	CERAMIC CHIP	0.001μF	10%	50V
C5840	1-164-936-11	CERAMIC CHIP	680pF	10%	50V	C5885	1-100-905-11	CERAMIC CHIP	0.001μF	10%	50V
C5841	1-112-067-11	CERAMIC CHIP	0.22μF	10%	16V	C5886	1-100-905-11	CERAMIC CHIP	0.001μF	10%	50V
C5842	1-164-874-11	CERAMIC CHIP	100pF	5%	50V	C5887	1-100-916-11	CERAMIC CHIP	0.1μF	10%	16V
C5843	1-100-905-11	CERAMIC CHIP	0.001μF	10%	50V	C5888	1-100-916-11	CERAMIC CHIP	0.1μF	10%	16V
C5844	1-100-916-11	CERAMIC CHIP	0.1μF	10%	16V	C5889	1-126-394-11	ELECT CHIP	10μF	20%	16V
C5845	1-100-905-11	CERAMIC CHIP	0.001μF	10%	50V	C5892	1-100-905-11	CERAMIC CHIP	0.001μF	10%	50V
C5846	1-100-905-11	CERAMIC CHIP	0.001μF	10%	50V	C5893	1-100-905-11	CERAMIC CHIP	0.001μF	10%	50V
C5847	1-100-905-11	CERAMIC CHIP	0.001μF	10%	50V	C5894	1-100-905-11	CERAMIC CHIP	0.001μF	10%	50V
C5848	1-100-905-11	CERAMIC CHIP	0.001μF	10%	50V	C5895	1-100-906-11	CERAMIC CHIP	0.01μF	10%	16V
C5849	1-100-905-11	CERAMIC CHIP	0.001μF	10%	50V	C5896	1-100-905-11	CERAMIC CHIP	0.001μF	10%	50V
C5850	1-100-905-11	CERAMIC CHIP	0.001μF	10%	50V	C5897	1-100-906-11	CERAMIC CHIP	0.01μF	10%	16V
C5851	1-100-905-11	CERAMIC CHIP	0.001μF	10%	50V	C5900	1-100-906-11	CERAMIC CHIP	0.01μF	10%	16V
C5852	1-100-905-11	CERAMIC CHIP	0.001μF	10%	50V	C5901	1-100-916-11	CERAMIC CHIP	0.1μF	10%	16V
C5853	1-100-905-11	CERAMIC CHIP	0.001μF	10%	50V	C5902	1-100-906-11	CERAMIC CHIP	0.01μF	10%	16V
C5854	1-100-916-11	CERAMIC CHIP	0.1μF	10%	16V	C5903	1-100-916-11	CERAMIC CHIP	0.1μF	10%	16V
C5855	1-126-394-11	ELECT CHIP	10μF	20%	16V	C5904	1-100-916-11	CERAMIC CHIP	0.1μF	10%	16V
C5856	1-100-916-11	CERAMIC CHIP	0.1μF	10%	16V	C5905	1-100-906-11	CERAMIC CHIP	0.01μF	10%	16V
C5857	1-100-916-11	CERAMIC CHIP	0.1μF	10%	16V	C5906	1-100-916-11	CERAMIC CHIP	0.1μF	10%	16V
C5858	1-126-394-11	ELECT CHIP	10μF	20%	16V	C5907	1-100-916-11	CERAMIC CHIP	0.1μF	10%	16V
C5859	1-100-916-11	CERAMIC CHIP	0.1μF	10%	16V	C5908	1-100-906-11	CERAMIC CHIP	0.01μF	10%	16V
C5860	1-100-905-11	CERAMIC CHIP	0.001μF	10%	50V	C5909	1-100-906-11	CERAMIC CHIP	0.01μF	10%	16V
C5861	1-100-916-11	CERAMIC CHIP	0.1μF	10%	16V	C5910	1-100-906-11	CERAMIC CHIP	0.01μF	10%	16V
C5862	1-100-905-11	CERAMIC CHIP	0.001μF	10%	50V	C5911	1-100-916-11	CERAMIC CHIP	0.1μF	10%	16V
C5863	1-100-905-11	CERAMIC CHIP	0.001μF	10%	50V	C5912	1-100-916-11	CERAMIC CHIP	0.1μF	10%	16V
C5864	1-100-905-11	CERAMIC CHIP	0.001μF	10%	50V	C7000	1-100-591-91	CERAMIC CHIP	1μF	10%	25V
C5865	1-100-905-11	CERAMIC CHIP	0.001μF	10%	50V	C7001	1-112-064-11	CERAMIC CHIP	2.2μF	10%	10V
C5866	1-100-905-11	CERAMIC CHIP	0.001μF	10%	50V	C7002	1-112-064-11	CERAMIC CHIP	2.2μF	10%	10V
C5867	1-100-905-11	CERAMIC CHIP	0.001μF	10%	50V	C7003	1-164-315-11	CERAMIC CHIP	470pF	5%	50V
C5868	1-100-905-11	CERAMIC CHIP	0.001μF	10%	50V	C7004	1-164-315-11	CERAMIC CHIP	470pF	5%	50V
C5869	1-100-905-11	CERAMIC CHIP	0.001μF	10%	50V	C7005	1-162-967-11	CERAMIC CHIP	0.0033μF	10%	50V



REF. NO.	PART NO.	DESCRIPTION	VALUES	REF. NO.	PART NO.	DESCRIPTION	VALUES
C7006	1-162-966-11	CERAMIC CHIP	0.0022μF 10% 50V	C7060	1-135-595-11	ELECT	100μF 20% 6.3V
C7007	1-100-552-21	ELECT CHIP	10μF 20% 25V	C7062	1-135-342-21	ELECT CHIP	56μF 20% 10V
C7008	1-164-004-11	CERAMIC CHIP	0.1μF 10% 25V	C7065	1-112-161-21	ELECT CHIP	1000μF 20% 6.3V
C7009	1-162-927-11	CERAMIC CHIP	100pF 5% 50V	C7067	1-112-797-11	ELECT CHIP	470μF 20% 25V
C7010	1-112-797-11	ELECT CHIP	470μF 20% 25V	C7068	1-164-874-11	CERAMIC CHIP	100pF 5% 50V
C7011	1-115-339-11	CERAMIC CHIP	0.1μF 10% 50V	C7069	1-164-874-11	CERAMIC CHIP	100pF 5% 50V
C7012	1-100-566-91	CERAMIC CHIP	0.1μF 10% 25V	C7070	1-100-905-11	CERAMIC CHIP	0.001μF 10% 50V
C7013	1-100-591-91	CERAMIC CHIP	1μF 10% 25V	C7079	1-164-874-11	CERAMIC CHIP	100pF 5% 50V
C7014	1-100-591-91	CERAMIC CHIP	1μF 10% 25V	C7080	1-164-874-11	CERAMIC CHIP	100pF 5% 50V
C7015	1-164-004-11	CERAMIC CHIP	0.1μF 10% 25V	C7081	1-164-874-11	CERAMIC CHIP	100pF 5% 50V
C7016	1-100-591-91	CERAMIC CHIP	1μF 10% 25V	C7082	1-100-905-11	CERAMIC CHIP	0.001μF 10% 50V
C7017	1-164-004-11	CERAMIC CHIP	0.1μF 10% 25V	C7083	1-100-905-11	CERAMIC CHIP	0.001μF 10% 50V
C7019	1-112-161-21	ELECT CHIP	1000μF 20% 6.3V	C7084	1-164-874-11	CERAMIC CHIP	100pF 5% 50V
C7020	1-164-934-11	CERAMIC CHIP	330pF 10% 50V	C7085	1-100-905-11	CERAMIC CHIP	0.001μF 10% 50V
C7022	1-100-911-11	CERAMIC CHIP	4.7μF 10% 25V	C7088	1-164-874-11	CERAMIC CHIP	100pF 5% 50V
C7023	1-100-911-11	CERAMIC CHIP	4.7μF 10% 25V	C7089	1-100-905-11	CERAMIC CHIP	0.001μF 10% 50V
C7025	1-125-827-91	CERAMIC CHIP	1μF 10% 25V	CONNECTOR			
C7026	1-125-827-91	CERAMIC CHIP	1μF 10% 25V	CN4001	1-819-390-51	FFC/FPC CONNECTOR (ZIF)	49P
C7027	1-164-939-11	CERAMIC CHIP	0.0022μF 10% 50V	CN4002	1-819-447-11	HEADER ASSEMBLY FOR PWB	
C7028	1-119-923-11	CERAMIC CHIP	0.047μF 10% 10V	CN4003	1-779-331-51	CONNECTOR, FFC/FPC	14P
C7029	1-100-566-91	CERAMIC CHIP	0.1μF 10% 25V	CN4004	1-779-936-51	CONNECTOR, FFC/FPC	18P
C7030	1-100-566-91	CERAMIC CHIP	0.1μF 10% 25V	CN4007	1-819-336-11	HEADER ASSEMBLY FOR PWB	
C7031	1-100-551-21	ELECT CHIP	22μF 20% 20V	CN4008	1-820-187-11	HEADER ASSEMBLY (PRINT PWB)	10P
C7032	1-135-346-21	ELECT CHIP	39μF 20% 16V	CN4300	1-819-337-11	HEADER ASSEMBLY FOR PWB	
C7033	1-100-566-91	CERAMIC CHIP	0.1μF 10% 25V	CN4400	1-820-284-11	D SUB CONNECTOR	
C7034	1-164-004-11	CERAMIC CHIP	0.1μF 10% 25V	CN4701	1-819-461-11	HEADER ASSEMBLY FOR PWB	
C7035	1-164-004-11	CERAMIC CHIP	0.1μF 10% 25V	CN4702	1-820-252-51	FFC/FPC CONNECTOR (ZIF)	40P
C7036	1-162-970-11	CERAMIC CHIP	0.01μF 10% 25V	CN5003	1-820-506-11	HEADER ASSEMBLY FOR PWB	
C7037	1-162-970-11	CERAMIC CHIP	0.01μF 10% 25V	CN5800	1-818-737-11	HDMI CONNECTOR	
C7039	1-100-905-11	CERAMIC CHIP	0.001μF 10% 50V	CN5801	1-818-737-11	HDMI CONNECTOR	
C7040	1-100-916-11	CERAMIC CHIP	0.1μF 10% 16V	* CN7002	1-780-408-11	TERMINAL	
C7041	1-100-567-81	CERAMIC CHIP	0.01μF 10% 25V	* CN7003	1-780-408-11	TERMINAL	
C7042	1-112-066-11	CERAMIC CHIP	10μF 10% 10V	* CN7004	1-780-408-11	TERMINAL	
C7043	1-164-939-11	CERAMIC CHIP	0.0022μF 10% 50V	* CN7005	1-780-408-11	TERMINAL	
C7044	1-100-909-11	CERAMIC CHIP	10μF 10% 6.3V	CN7008	1-820-186-11	HEADER ASSEMBLY (PRINT PWB)	
C7045	1-131-661-21	ELECT CHIP	100μF 20% 10V	CN7009	1-820-186-11	HEADER ASSEMBLY (PRINT PWB)	
C7046	1-100-906-11	CERAMIC CHIP	0.01μF 10% 16V	* CN7010	1-780-408-11	TERMINAL	
C7047	1-165-672-21	ELECT CHIP	47μF 20% 10V	* CN7011	1-780-408-11	TERMINAL	
C7048	1-164-878-11	CERAMIC CHIP	150pF 5% 50V	* CN7012	1-780-408-11	TERMINAL	
C7049	1-100-566-91	CERAMIC CHIP	0.1μF 10% 25V	* CN7013	1-780-408-11	TERMINAL	
C7050	1-126-392-11	ELECT CHIP	100μF 20% 6.3V	* CN7014	1-780-408-11	TERMINAL	
C7051	1-100-566-91	CERAMIC CHIP	0.1μF 10% 25V	* CN7015	1-780-408-11	TERMINAL	
C7054	1-100-916-11	CERAMIC CHIP	0.1μF 10% 16V	* CN7016	1-780-408-11	TERMINAL	
C7056	1-100-905-11	CERAMIC CHIP	0.001μF 10% 50V	* CN7017	1-780-408-11	TERMINAL	
C7057	1-112-046-11	CERAMIC CHIP	4.7μF 10% 6.3V	* CN7018	1-780-408-11	TERMINAL	
C7058	1-100-906-11	CERAMIC CHIP	0.01μF 10% 16V	* CN7019	1-780-408-11	TERMINAL	

NOTE: The components identified by shading and \triangle mark are critical for safety. Replace only with part number specified.

NOTE: Les composants identifiés par un triangle et une marque \triangle sont critiques pour la sécurité. Ne les remplacer que par une pièce portant le numéro spécifié.



REF. NO.	PART NO.	DESCRIPTION	VALUES	REF. NO.	PART NO.	DESCRIPTION	VALUES
DIODE				FB4012	1-400-807-21	FERRITE	0 μ H
D4002	8-719-058-24	DIODE	RB501V-40TE-17	FB4013	1-400-807-21	FERRITE	0 μ H
D4006	8-719-073-01	DIODE	MA111-(K8).S0	FB4014	1-400-807-21	FERRITE	0 μ H
D4007	8-719-077-59	DIODE	1PS302	FB4015	1-400-807-21	FERRITE	0 μ H
D4020	8-719-422-46	DIODE	MA8056	FB4016	1-400-807-21	FERRITE	0 μ H
D4021	8-719-422-46	DIODE	MA8056	FB4017	1-400-794-21	FERRITE	0 μ H
D4400	8-719-422-46	DIODE	MA8056	FB4018	1-400-794-21	FERRITE	0 μ H
D4401	8-719-422-46	DIODE	MA8056	FB4019	1-400-591-22	FERRITE	0 μ H
D4402	8-719-422-46	DIODE	MA8056	FB4020	1-400-141-22	FERRITE	0 μ H
D4403	8-719-050-38	DIODE	M1MA152WK-T1	FB4021	1-400-141-22	FERRITE	0 μ H
D4500	8-719-056-84	DIODE	UDZ-TE-17-7.5B	FB4022	1-400-807-21	FERRITE	0 μ H
D4508	8-719-073-01	DIODE	MA111-(K8).S0	FB4023	1-400-807-21	FERRITE	0 μ H
D4509	8-719-073-01	DIODE	MA111-(K8).S0	FB4320	1-400-141-22	FERRITE	0 μ H
D4510	8-719-073-01	DIODE	MA111-(K8).S0	FB4321	1-400-141-22	FERRITE	0 μ H
D4511	8-719-073-01	DIODE	MA111-(K8).S0	FB4400	1-469-100-21	FERRITE	0 μ H
D5801	8-719-073-01	DIODE	MA111-(K8).S0	FB4401	1-469-100-21	FERRITE	0 μ H
D5802	8-719-073-01	DIODE	MA111-(K8).S0	FB4402	1-469-100-21	FERRITE	0 μ H
D5804	8-719-073-01	DIODE	MA111-(K8).S0	FB4404	1-469-100-21	FERRITE	0 μ H
D5813	8-719-073-01	DIODE	MA111-(K8).S0	FB4405	1-400-141-22	FERRITE	0 μ H
D7000	6-500-215-01	DIODE	M2FM3	FB5000	1-400-461-21	FERRITE	0 μ H
D7001	8-719-072-43	DIODE	RB050L-40TE25	FB5001	1-400-461-21	FERRITE	0 μ H
D7002	6-500-294-01	DIODE	PTZ-TE25-3.9B	FB5002	1-400-461-21	FERRITE	0 μ H
D7003	6-500-294-01	DIODE	PTZ-TE25-3.9B	FB5003	1-400-461-21	FERRITE	0 μ H
D7004	8-719-072-43	DIODE	RB050L-40TE25	FB5004	1-400-461-21	FERRITE	0 μ H
D7005	8-719-072-43	DIODE	RB050L-40TE25	FB5005	1-400-461-21	FERRITE	0 μ H
D7006	8-719-073-01	DIODE	MA111-(K8).S0	FB5006	1-400-461-21	FERRITE	0 μ H
D7007	8-719-072-43	DIODE	RB050L-40TE25	FB5008	1-400-794-21	FERRITE	0 μ H
D7008	8-719-068-71	DIODE	PTZ-TE25-13A	FB5300	1-400-794-21	FERRITE	0 μ H
D7009	8-719-084-56	DIODE	PTZ-TE25-15B	FB5301	1-400-794-21	FERRITE	0 μ H
D7010	6-500-295-01	DIODE	PTZ-TE25-5.6B	FB5302	1-400-794-21	FERRITE	0 μ H
FUSE				FB5501	1-400-794-21	FERRITE	0 μ H
\triangle F7000	1-576-603-21	FUSE	3.15A 24V	FB5502	1-400-794-21	FERRITE	0 μ H
FERRITE BEAD				FB5800	1-469-094-21	FERRITE	0 μ H
FB4001	1-414-227-11	FERRITE	0 μ H	FB5801	1-400-461-21	FERRITE	0 μ H
FB4002	1-400-177-21	FERRITE	0 μ H	FB5802	1-414-235-22	FERRITE	0 μ H
FB4004	1-400-110-21	FERRITE	0 μ H	FB5803	1-414-235-22	FERRITE	0 μ H
FB4005	1-400-110-21	FERRITE	0 μ H	FB5804	1-400-461-21	FERRITE	0 μ H
FB4006	1-400-110-21	FERRITE	0 μ H	FB5805	1-400-461-21	FERRITE	0 μ H
FB4007	1-400-110-21	FERRITE	0 μ H	FB5806	1-414-235-22	FERRITE	0 μ H
FB4008	1-400-331-11	FERRITE	0 μ H	FB5807	1-400-461-21	FERRITE	0 μ H
FB4009	1-400-807-21	FERRITE	0 μ H	FB5808	1-400-382-11	FERRITE	0 μ H
FB4010	1-400-591-22	FERRITE	0 μ H	FB5809	1-400-382-11	FERRITE	0 μ H
FB4011	1-400-807-21	FERRITE	0 μ H	FB7000	1-400-794-21	FERRITE	0 μ H
				FB7001	1-414-445-11	FERRITE	0 μ H
				FB7002	1-414-445-11	FERRITE	0 μ H

NOTE: The components identified by shading and Δ mark are critical for safety. Replace only with part number specified.

NOTE: Les composants identifiés par un trame et une marque Δ sont critiques pour la sécurité. Ne les remplacer que par une pièce portant le numéro spécifié.



REF. NO.	PART NO.	DESCRIPTION	VALUES	REF. NO.	PART NO.	DESCRIPTION	VALUES
IC LINK				Q7015	8-729-028-77	TRANSISTOR	DTA115EUA-T106
PS4400	1-576-122-21	IC LINK	0.4A 72V	Q7016	8-729-029-00	TRANSISTOR	DTC115EUA-T106
Δ PS7000	1-576-603-21	FUSE	3.15A 24V	RESISTOR			
TRANSISTOR				R4002	1-216-864-11	SHORT CHIP	
Q4001	6-551-387-01	TRANSISTOR	SSM6N16FU	R4003	1-218-961-11	RES-CHIP	4.7K 5% 1/16W
Q4003	8-729-028-74	TRANSISTOR	DTA114TUA-T106	R4004	1-218-961-11	RES-CHIP	4.7K 5% 1/16W
Q4004	8-729-013-28	TRANSISTOR	HN1B01FU-TE85R	R4005	1-216-821-11	METAL CHIP	1K 5% 1/10W
Q4005	8-729-028-74	TRANSISTOR	DTA114TUA-T106	R4007	1-218-937-11	RES-CHIP	47 5% 1/16W
Q4006	8-729-029-04	TRANSISTOR	DTC123JUA-T106	R4008	1-218-937-11	RES-CHIP	47 5% 1/16W
Q4007	8-729-028-96	TRANSISTOR	DTC114EUA-T106	R4009	1-218-937-11	RES-CHIP	47 5% 1/16W
Q4285	8-729-029-00	TRANSISTOR	DTC115EUA-T106	R4010	1-218-990-81	SHORT CHIP	
Q4286	8-729-028-77	TRANSISTOR	DTA115EUA-T106	R4011	1-216-864-11	SHORT CHIP	
Q4400	8-729-120-28	TRANSISTOR	2SC1623-L5L6	R4012	1-216-864-11	SHORT CHIP	
Q4401	8-729-120-28	TRANSISTOR	2SC1623-L5L6	R4013	1-216-801-11	METAL CHIP	22 5% 1/10W
Q4500	8-729-028-96	TRANSISTOR	DTC114EUA-T106	R4014	1-216-801-11	METAL CHIP	22 5% 1/10W
Q4502	8-729-028-96	TRANSISTOR	DTC114EUA-T106	R4015	1-216-864-11	SHORT CHIP	
Q4503	8-729-028-96	TRANSISTOR	DTC114EUA-T106	R4016	1-216-801-11	METAL CHIP	22 5% 1/10W
Q4504	8-729-028-96	TRANSISTOR	DTC114EUA-T106	R4017	1-216-801-11	METAL CHIP	22 5% 1/10W
Q4505	8-729-028-96	TRANSISTOR	DTC114EUA-T106	R4018	1-216-864-11	SHORT CHIP	
Q4506	8-729-028-96	TRANSISTOR	DTC114EUA-T106	R4019	1-216-864-11	SHORT CHIP	
Q4507	8-729-028-96	TRANSISTOR	DTC114EUA-T106	R4021	1-216-801-11	METAL CHIP	22 5% 1/10W
Q5200	8-729-602-36	TRANSISTOR	2SA1602-F	R4022	1-216-801-11	METAL CHIP	22 5% 1/10W
Q5201	8-729-602-36	TRANSISTOR	2SA1602-F	R4023	1-216-801-11	METAL CHIP	22 5% 1/10W
Q5800	8-729-028-96	TRANSISTOR	DTC114EUA-T106	R4024	1-216-801-11	METAL CHIP	22 5% 1/10W
Q5801	8-729-025-28	TRANSISTOR	2SK1828	R4025	1-216-864-11	SHORT CHIP	
Q5802	8-729-028-96	TRANSISTOR	DTC114EUA-T106	R4026	1-216-801-11	METAL CHIP	22 5% 1/10W
Q5803	8-729-025-28	TRANSISTOR	2SK1828	R4027	1-218-990-81	SHORT CHIP	
Q5804	8-729-120-28	TRANSISTOR	2SC1623-L5L6	R4028	1-216-864-11	SHORT CHIP	
Q5805	8-729-120-28	TRANSISTOR	2SC1623-L5L6	R4029	1-216-864-11	SHORT CHIP	
Q5807	6-551-364-01	TRANSISTOR	DTC614TUT106	R4031	1-218-887-11	METAL CHIP	47K 0.50% 1/10W
Q5808	6-551-364-01	TRANSISTOR	DTC614TUT106	R4032	1-216-864-11	SHORT CHIP	
Q5810	8-729-028-96	TRANSISTOR	DTC114EUA-T106	R4033	1-216-864-11	SHORT CHIP	
Q5812	6-550-014-01	TRANSISTOR	SSM6N15FU(TE85R)	R4034	1-218-863-11	METAL CHIP	4.7K 0.50% 1/10W
Q5813	6-550-014-01	TRANSISTOR	SSM6N15FU(TE85R)	R4035	1-216-864-11	SHORT CHIP	
Q7000	6-550-652-01	TRANSISTOR	FDS4435A	R4036	1-218-963-11	RES-CHIP	6.8K 5% 1/16W
Q7001	6-550-828-01	TRANSISTOR	RSQ035P03TR	R4037	1-218-867-11	METAL CHIP	6.8K 0.50% 1/10W
Q7002	6-550-828-01	TRANSISTOR	RSQ035P03TR	R4038	1-218-963-11	RES-CHIP	6.8K 5% 1/16W
* Q7003	6-550-663-01	TRANSISTOR	RSS100N03TB	R4039	1-216-864-11	SHORT CHIP	
Q7004	6-550-355-01	TRANSISTOR	RTQ045N03TR	R4045	1-218-965-11	RES-CHIP	10K 5% 1/16W
Q7005	6-550-851-01	TRANSISTOR	RSS050P03FTB	R4046	1-216-864-11	SHORT CHIP	
Q7007	8-729-602-21	TRANSISTOR	2SC4154-F	R4047	1-216-864-11	SHORT CHIP	
Q7008	8-729-028-96	TRANSISTOR	DTC114EUA-T106	R4048	1-216-864-11	SHORT CHIP	
* Q7009	6-550-663-01	TRANSISTOR	RSS100N03TB	R4049	1-218-965-11	RES-CHIP	10K 5% 1/16W
Q7012	8-729-029-00	TRANSISTOR	DTC115EUA-T106				



REF. NO.	PART NO.	DESCRIPTION	VALUES			REF. NO.	PART NO.	DESCRIPTION	VALUES		
R4052	1-216-864-11	SHORT CHIP				R4186	1-218-990-81	SHORT CHIP			
R4055	1-218-990-81	SHORT CHIP				R4188	1-218-990-81	SHORT CHIP			
R4056	1-218-990-81	SHORT CHIP				R4190	1-208-886-81	METAL CHIP	910	0.50%	1/16W
R4059	1-216-864-11	SHORT CHIP				R4191	1-218-969-11	RES-CHIP	22K	5%	1/16W
R4064	1-218-965-11	RES-CHIP	10K	5%	1/16W	R4192	1-218-941-81	RES-CHIP	100	5%	1/16W
R4065	1-218-965-11	RES-CHIP	10K	5%	1/16W	R4193	1-218-965-11	RES-CHIP	10K	5%	1/16W
R4067	1-216-864-11	SHORT CHIP				R4195	1-218-990-81	SHORT CHIP			
R4068	1-218-990-81	SHORT CHIP				R4196	1-218-965-11	RES-CHIP	10K	5%	1/16W
R4069	1-208-855-81	METAL CHIP	47	0.50%	1/16W	R4198	1-218-990-81	SHORT CHIP			
R4070	1-216-864-11	SHORT CHIP				R4199	1-218-941-81	RES-CHIP	100	5%	1/16W
R4071	1-218-990-81	SHORT CHIP				R4205	1-218-990-81	SHORT CHIP			
R4074	1-218-990-81	SHORT CHIP				R4206	1-218-965-11	RES-CHIP	10K	5%	1/16W
R4075	1-218-965-11	RES-CHIP	10K	5%	1/16W	R4207	1-218-949-11	RES-CHIP	470	5%	1/16W
R4076	1-218-965-11	RES-CHIP	10K	5%	1/16W	R4208	1-218-990-81	SHORT CHIP			
R4077	1-218-965-11	RES-CHIP	10K	5%	1/16W	R4209	1-218-990-81	SHORT CHIP			
R4078	1-216-864-11	SHORT CHIP				R4210	1-218-949-11	RES-CHIP	470	5%	1/16W
R4082	1-218-965-11	RES-CHIP	10K	5%	1/16W	R4211	1-218-965-11	RES-CHIP	10K	5%	1/16W
R4088	1-218-965-11	RES-CHIP	10K	5%	1/16W	R4212	1-218-949-11	RES-CHIP	470	5%	1/16W
R4092	1-216-864-11	SHORT CHIP				R4218	1-218-961-11	RES-CHIP	4.7K	5%	1/16W
R4093	1-216-864-11	SHORT CHIP				R4223	1-218-945-11	RES-CHIP	220	5%	1/16W
R4096	1-208-699-11	METAL CHIP	4.7K	0.50%	1/16W	R4224	1-218-990-81	SHORT CHIP			
R4097	1-208-679-11	METAL CHIP	680	0.50%	1/16W	R4225	1-218-937-11	RES-CHIP	47	5%	1/16W
R4098	1-208-691-11	METAL CHIP	2.2K	0.50%	1/16W	R4226	1-218-945-11	RES-CHIP	220	5%	1/16W
R4099	1-216-864-11	SHORT CHIP				R4227	1-218-937-11	RES-CHIP	47	5%	1/16W
R4100	1-216-864-11	SHORT CHIP				R4235	1-218-990-81	SHORT CHIP			
R4101	1-218-959-11	RES-CHIP	3.3K	5%	1/16W	R4239	1-218-990-81	SHORT CHIP			
R4103	1-218-965-11	RES-CHIP	10K	5%	1/16W	R4240	1-208-943-11	METAL CHIP	220K	0.50%	1/16W
R4111	1-218-933-11	RES-CHIP	22	5%	1/16W	R4242	1-218-941-81	RES-CHIP	100	5%	1/16W
R4113	1-218-933-11	RES-CHIP	22	5%	1/16W	R4243	1-216-809-11	METAL CHIP	100	5%	1/10W
R4120	1-216-864-11	SHORT CHIP				R4246	1-218-965-11	RES-CHIP	10K	5%	1/16W
R4121	1-216-864-11	SHORT CHIP				R4247	1-216-864-11	SHORT CHIP			
R4122	1-216-864-11	SHORT CHIP				R4255	1-400-591-22	FERRITE	0μH		
R4123	1-216-864-11	SHORT CHIP				R4256	1-400-591-22	FERRITE	0μH		
R4124	1-216-864-11	SHORT CHIP				R4257	1-400-591-22	FERRITE	0μH		
R4125	1-216-864-11	SHORT CHIP				R4258	1-400-591-22	FERRITE	0μH		
R4134	1-218-965-11	RES-CHIP	10K	5%	1/16W	R4259	1-400-591-22	FERRITE	0μH		
R4144	1-208-691-11	METAL CHIP	2.2K	0.50%	1/16W	R4260	1-400-591-22	FERRITE	0μH		
R4161	1-218-965-11	RES-CHIP	10K	5%	1/16W	R4261	1-400-591-22	FERRITE	0μH		
R4162	1-218-973-11	RES-CHIP	47K	5%	1/16W	R4262	1-400-591-22	FERRITE	0μH		
R4164	1-218-965-11	RES-CHIP	10K	5%	1/16W	R4263	1-400-591-22	FERRITE	0μH		
R4165	1-218-965-11	RES-CHIP	10K	5%	1/16W	R4264	1-400-591-22	FERRITE	0μH		
R4167	1-218-965-11	RES-CHIP	10K	5%	1/16W	R4265	1-400-591-22	FERRITE	0μH		
R4168	1-218-965-11	RES-CHIP	10K	5%	1/16W	R4266	1-216-864-11	SHORT CHIP			
R4169	1-216-864-11	SHORT CHIP				R4267	1-400-591-22	FERRITE	0μH		
R4180	1-218-965-11	RES-CHIP	10K	5%	1/16W	R4270	1-218-941-81	RES-CHIP	100	5%	1/16W



REF. NO.	PART NO.	DESCRIPTION	VALUES			REF. NO.	PART NO.	DESCRIPTION	VALUES		
R4271	1-218-990-81	SHORT CHIP				R4507	1-218-963-11	RES-CHIP	6.8K	5%	1/16W
R4272	1-218-990-81	SHORT CHIP				R4510	1-218-990-81	SHORT CHIP			
R4290	1-218-990-81	SHORT CHIP				R4515	1-208-935-11	METAL CHIP	100K	0.50%	1/16W
R4295	1-208-721-11	METAL CHIP	39K	0.50%	1/16W	R4516	1-208-721-11	METAL CHIP	39K	0.50%	1/16W
R4301	1-208-941-11	METAL CHIP	180K	0.50%	1/16W	R4517	1-208-935-11	METAL CHIP	100K	0.50%	1/16W
R4302	1-218-941-11	RES-CHIP	100	5%	1/16W	R4518	1-208-923-11	METAL CHIP	33K	0.50%	1/16W
R4307	1-218-990-81	SHORT CHIP				R4542	1-218-965-11	RES-CHIP	10K	5%	1/16W
R4308	1-218-990-81	SHORT CHIP				R4543	1-218-965-11	RES-CHIP	10K	5%	1/16W
R4309	1-218-957-11	RES-CHIP	2.2K	5%	1/16W	R4544	1-218-965-11	RES-CHIP	10K	5%	1/16W
R4310	1-218-957-11	RES-CHIP	2.2K	5%	1/16W	R4545	1-218-977-11	RES-CHIP	100K	5%	1/16W
R4311	1-208-947-11	METAL CHIP	330K	0.50%	1/16W	R4546	1-218-965-11	RES-CHIP	10K	5%	1/16W
R4313	1-216-864-11	SHORT CHIP				R4547	1-218-965-11	RES-CHIP	10K	5%	1/16W
R4314	1-216-864-11	SHORT CHIP				R4705	1-218-990-81	SHORT CHIP			
R4315	1-216-864-11	SHORT CHIP				R4711	1-218-937-11	RES-CHIP	47	5%	1/16W
R4316	1-216-864-11	SHORT CHIP				R4712	1-218-937-11	RES-CHIP	47	5%	1/16W
R4400	1-216-805-11	METAL CHIP	47	5%	1/10W	R4713	1-218-933-11	RES-CHIP	22	5%	1/16W
R4401	1-216-805-11	METAL CHIP	47	5%	1/10W	R4715	1-218-969-11	RES-CHIP	22K	5%	1/16W
R4404	1-218-985-11	RES-CHIP	470K	5%	1/16W	R4716	1-218-969-11	RES-CHIP	22K	5%	1/16W
R4405	1-218-985-11	RES-CHIP	470K	5%	1/16W	R4717	1-218-969-11	RES-CHIP	22K	5%	1/16W
R4406	1-216-833-11	METAL CHIP	10K	5%	1/10W	R4718	1-218-969-11	RES-CHIP	22K	5%	1/16W
R4407	1-208-683-11	METAL CHIP	1K	0.50%	1/16W	R4719	1-216-864-11	SHORT CHIP			
R4408	1-208-683-11	METAL CHIP	1K	0.50%	1/16W	R4720	1-216-864-11	SHORT CHIP			
R4409	1-216-833-11	METAL CHIP	10K	5%	1/10W	R4721	1-218-937-11	RES-CHIP	47	5%	1/16W
R4410	1-216-805-11	METAL CHIP	47	5%	1/10W	R4722	1-218-937-11	RES-CHIP	47	5%	1/16W
R4411	1-216-805-11	METAL CHIP	47	5%	1/10W	R4724	1-218-990-81	SHORT CHIP			
R4412	1-218-827-11	METAL CHIP	150	0.50%	1/10W	R4725	1-218-965-11	RES-CHIP	10K	5%	1/16W
R4413	1-218-827-11	METAL CHIP	150	0.50%	1/10W	R4726	1-218-965-11	RES-CHIP	10K	5%	1/16W
R4414	1-218-827-11	METAL CHIP	150	0.50%	1/10W	R5004	1-218-990-81	SHORT CHIP			
R4415	1-218-827-11	METAL CHIP	150	0.50%	1/10W	R5007	1-218-990-81	SHORT CHIP			
R4416	1-216-821-11	METAL CHIP	1K	5%	1/10W	R5009	1-218-965-11	RES-CHIP	10K	5%	1/16W
R4417	1-218-827-11	METAL CHIP	150	0.50%	1/10W	R5012	1-218-965-11	RES-CHIP	10K	5%	1/16W
R4418	1-218-827-11	METAL CHIP	150	0.50%	1/10W	R5013	1-218-965-11	RES-CHIP	10K	5%	1/16W
R4419	1-216-845-11	METAL CHIP	100K	5%	1/10W	R5015	1-218-989-11	RES-CHIP	1M	5%	1/16W
R4421	1-216-801-11	METAL CHIP	22	5%	1/10W	R5017	1-218-990-81	SHORT CHIP			
R4422	1-216-801-11	METAL CHIP	22	5%	1/10W	R5018	1-218-941-11	RES-CHIP	100	5%	1/16W
R4423	1-216-801-11	METAL CHIP	22	5%	1/10W	R5019	1-208-699-11	METAL CHIP	4.7K	0.50%	1/16W
R4429	1-216-801-11	METAL CHIP	22	5%	1/10W	R5020	1-218-961-11	RES-CHIP	4.7K	5%	1/16W
R4430	1-216-801-11	METAL CHIP	22	5%	1/10W	R5021	1-218-961-11	RES-CHIP	4.7K	5%	1/16W
R4441	1-208-939-11	METAL CHIP	150K	0.50%	1/16W	R5022	1-218-961-11	RES-CHIP	4.7K	5%	1/16W
R4442	1-208-939-11	METAL CHIP	150K	0.50%	1/16W	R5024	1-218-965-11	RES-CHIP	10K	5%	1/16W
R4443	1-208-939-11	METAL CHIP	150K	0.50%	1/16W	R5032	1-218-961-11	RES-CHIP	4.7K	5%	1/16W
R4444	1-208-939-11	METAL CHIP	150K	0.50%	1/16W	R5039	1-218-935-11	RES-CHIP	33	5%	1/16W
R4445	1-216-821-11	METAL CHIP	1K	5%	1/10W	R5200	1-218-957-11	RES-CHIP	2.2K	5%	1/16W
R4446	1-216-821-11	METAL CHIP	1K	5%	1/10W	R5201	1-218-957-11	RES-CHIP	2.2K	5%	1/16W
R4506	1-218-963-11	RES-CHIP	6.8K	5%	1/16W	R5202	1-216-821-11	METAL CHIP	1K	5%	1/10W



REF. NO.	PART NO.	DESCRIPTION	VALUES			REF. NO.	PART NO.	DESCRIPTION	VALUES		
R5203	1-216-821-11	METAL CHIP	1K	5%	1/10W	R5259	1-218-990-81	SHORT CHIP			
R5204	1-218-957-11	RES-CHIP	2.2K	5%	1/16W	R5260	1-218-961-11	RES-CHIP	4.7K	5%	1/16W
R5205	1-218-957-11	RES-CHIP	2.2K	5%	1/16W	R5261	1-218-961-11	RES-CHIP	4.7K	5%	1/16W
R5206	1-216-821-11	METAL CHIP	1K	5%	1/10W	R5262	1-218-961-11	RES-CHIP	4.7K	5%	1/16W
R5207	1-216-821-11	METAL CHIP	1K	5%	1/10W	R5263	1-218-961-11	RES-CHIP	4.7K	5%	1/16W
R5209	1-218-961-11	RES-CHIP	4.7K	5%	1/16W	R5264	1-218-961-11	RES-CHIP	4.7K	5%	1/16W
R5210	1-218-961-11	RES-CHIP	4.7K	5%	1/16W	R5265	1-218-961-11	RES-CHIP	4.7K	5%	1/16W
R5211	1-218-961-11	RES-CHIP	4.7K	5%	1/16W	R5304	1-216-295-91	SHORT CHIP			
R5212	1-218-961-11	RES-CHIP	4.7K	5%	1/16W	R5500	1-218-661-11	METAL CHIP	51	0.50%	1/10W
R5213	1-218-961-11	RES-CHIP	4.7K	5%	1/16W	R5501	1-218-937-11	RES-CHIP	47	5%	1/16W
R5214	1-218-961-11	RES-CHIP	4.7K	5%	1/16W	R5502	1-218-661-11	METAL CHIP	51	0.50%	1/10W
R5215	1-218-961-11	RES-CHIP	4.7K	5%	1/16W	R5503	1-218-937-11	RES-CHIP	47	5%	1/16W
R5219	1-216-864-11	SHORT CHIP				R5504	1-218-933-11	RES-CHIP	22	5%	1/16W
R5220	1-216-864-11	SHORT CHIP				R5505	1-218-937-11	RES-CHIP	47	5%	1/16W
R5221	1-218-961-11	RES-CHIP	4.7K	5%	1/16W	R5506	1-218-937-11	RES-CHIP	47	5%	1/16W
R5222	1-218-961-11	RES-CHIP	4.7K	5%	1/16W	R5509	1-218-937-11	RES-CHIP	47	5%	1/16W
R5223	1-218-961-11	RES-CHIP	4.7K	5%	1/16W	R5510	1-218-937-11	RES-CHIP	47	5%	1/16W
R5224	1-218-933-11	RES-CHIP	22	5%	1/16W	R5511	1-218-933-11	RES-CHIP	22	5%	1/16W
R5225	1-218-933-11	RES-CHIP	22	5%	1/16W	R5512	1-218-933-11	RES-CHIP	22	5%	1/16W
R5226	1-218-990-81	SHORT CHIP				R5513	1-218-939-11	RES-CHIP	68	5%	1/16W
R5227	1-218-990-81	SHORT CHIP				R5514	1-218-939-11	RES-CHIP	68	5%	1/16W
R5228	1-218-990-81	SHORT CHIP				R5515	1-218-939-11	RES-CHIP	68	5%	1/16W
R5229	1-218-990-81	SHORT CHIP				R5516	1-218-939-11	RES-CHIP	68	5%	1/16W
R5230	1-218-990-81	SHORT CHIP				R5517	1-218-661-11	METAL CHIP	51	0.50%	1/10W
R5231	1-218-990-81	SHORT CHIP				R5518	1-218-937-11	RES-CHIP	47	5%	1/16W
R5232	1-218-990-81	SHORT CHIP				R5519	1-218-661-11	METAL CHIP	51	0.50%	1/10W
R5233	1-218-990-81	SHORT CHIP				R5520	1-218-937-11	RES-CHIP	47	5%	1/16W
R5234	1-218-990-81	SHORT CHIP				R5522	1-218-847-11	METAL CHIP	1K	0.50%	1/10W
R5235	1-218-961-11	RES-CHIP	4.7K	5%	1/16W	R5523	1-218-847-11	METAL CHIP	1K	0.50%	1/10W
R5236	1-218-961-11	RES-CHIP	4.7K	5%	1/16W	R5524	1-218-937-11	RES-CHIP	47	5%	1/16W
R5238	1-218-961-11	RES-CHIP	4.7K	5%	1/16W	R5525	1-218-937-11	RES-CHIP	47	5%	1/16W
R5239	1-218-961-11	RES-CHIP	4.7K	5%	1/16W	R5526	1-218-937-11	RES-CHIP	47	5%	1/16W
R5241	1-218-961-11	RES-CHIP	4.7K	5%	1/16W	R5527	1-218-937-11	RES-CHIP	47	5%	1/16W
R5243	1-218-961-11	RES-CHIP	4.7K	5%	1/16W	R5530	1-218-939-11	RES-CHIP	68	5%	1/16W
R5245	1-218-961-11	RES-CHIP	4.7K	5%	1/16W	R5531	1-218-939-11	RES-CHIP	68	5%	1/16W
R5247	1-218-990-81	SHORT CHIP				R5532	1-218-939-11	RES-CHIP	68	5%	1/16W
R5248	1-218-990-81	SHORT CHIP				R5533	1-218-939-11	RES-CHIP	68	5%	1/16W
R5251	1-218-990-81	SHORT CHIP				R5534	1-218-933-11	RES-CHIP	22	5%	1/16W
R5252	1-218-990-81	SHORT CHIP				R5535	1-218-933-11	RES-CHIP	22	5%	1/16W
R5253	1-218-990-81	SHORT CHIP				R5536	1-218-933-11	RES-CHIP	22	5%	1/16W
R5254	1-218-990-81	SHORT CHIP				R5537	1-218-933-11	RES-CHIP	22	5%	1/16W
R5255	1-218-990-81	SHORT CHIP				R5538	1-218-933-11	RES-CHIP	22	5%	1/16W
R5256	1-218-990-81	SHORT CHIP				R5539	1-218-933-11	RES-CHIP	22	5%	1/16W
R5257	1-218-990-81	SHORT CHIP				R5540	1-218-933-11	RES-CHIP	22	5%	1/16W
R5258	1-218-990-81	SHORT CHIP				R5541	1-218-933-11	RES-CHIP	22	5%	1/16W



REF. NO.	PART NO.	DESCRIPTION	VALUES			REF. NO.	PART NO.	DESCRIPTION	VALUES		
R5543	1-218-933-11	RES-CHIP	22	5%	1/16W	R5840	1-208-697-11	METAL CHIP	3.9K	0.50%	1/16W
R5544	1-218-933-11	RES-CHIP	22	5%	1/16W	R5841	1-208-697-11	METAL CHIP	3.9K	0.50%	1/16W
R5545	1-218-933-11	RES-CHIP	22	5%	1/16W	R5844	1-218-929-11	RES-CHIP	10	5%	1/16W
R5546	1-218-933-11	RES-CHIP	22	5%	1/16W	R5845	1-218-929-11	RES-CHIP	10	5%	1/16W
R5547	1-218-933-11	RES-CHIP	22	5%	1/16W	R5846	1-218-929-11	RES-CHIP	10	5%	1/16W
R5548	1-218-933-11	RES-CHIP	22	5%	1/16W	R5847	1-208-697-11	METAL CHIP	3.9K	0.50%	1/16W
R5549	1-218-933-11	RES-CHIP	22	5%	1/16W	R5848	1-218-929-11	RES-CHIP	10	5%	1/16W
R5550	1-218-933-11	RES-CHIP	22	5%	1/16W	R5849	1-218-929-11	RES-CHIP	10	5%	1/16W
R5802	1-218-929-11	RES-CHIP	10	5%	1/16W	R5850	1-218-929-11	RES-CHIP	10	5%	1/16W
R5803	1-208-683-11	METAL CHIP	1K	0.50%	1/16W	R5851	1-218-929-11	RES-CHIP	10	5%	1/16W
R5804	1-218-990-81	SHORT CHIP				R5856	1-218-929-11	RES-CHIP	10	5%	1/16W
R5805	1-218-929-11	RES-CHIP	10	5%	1/16W	R5857	1-208-697-11	METAL CHIP	3.9K	0.50%	1/16W
R5806	1-208-683-11	METAL CHIP	1K	0.50%	1/16W	R5859	1-208-697-11	METAL CHIP	3.9K	0.50%	1/16W
R5807	1-218-990-81	SHORT CHIP				R5860	1-218-957-11	RES-CHIP	2.2K	5%	1/16W
R5808	1-218-990-81	SHORT CHIP				R5861	1-218-957-11	RES-CHIP	2.2K	5%	1/16W
R5809	1-218-990-81	SHORT CHIP				R5862	1-208-939-11	METAL CHIP	150K	0.50%	1/16W
R5810	1-216-864-11	SHORT CHIP				R5863	1-208-939-11	METAL CHIP	150K	0.50%	1/16W
R5811	1-218-985-11	RES-CHIP	470K	5%	1/16W	R5864	1-216-821-11	METAL CHIP	1K	5%	1/10W
R5812	1-218-985-11	RES-CHIP	470K	5%	1/16W	R5865	1-208-939-11	METAL CHIP	150K	0.50%	1/16W
R5813	1-208-911-11	METAL CHIP	10K	0.50%	1/16W	R5866	1-208-939-11	METAL CHIP	150K	0.50%	1/16W
R5814	1-216-864-11	SHORT CHIP				R5867	1-216-821-11	METAL CHIP	1K	5%	1/10W
R5815	1-208-683-11	METAL CHIP	1K	0.50%	1/16W	R5870	1-218-953-11	RES-CHIP	1K	5%	1/16W
R5816	1-208-683-11	METAL CHIP	1K	0.50%	1/16W	R5871	1-218-935-11	RES-CHIP	33	5%	1/16W
R5817	1-218-941-81	RES-CHIP	100	5%	1/16W	R5872	1-218-973-11	RES-CHIP	47K	5%	1/16W
R5818	1-218-941-81	RES-CHIP	100	5%	1/16W	R5873	1-218-973-11	RES-CHIP	47K	5%	1/16W
R5819	1-218-990-81	SHORT CHIP				R5875	1-218-989-11	RES-CHIP	1M	5%	1/16W
R5820	1-218-990-81	SHORT CHIP				R5877	1-218-956-11	RES-CHIP	1.8K	5%	1/16W
R5821	1-208-911-11	METAL CHIP	10K	0.50%	1/16W	R5878	1-218-989-11	RES-CHIP	1M	5%	1/16W
R5822	1-218-973-11	RES-CHIP	47K	5%	1/16W	R5879	1-218-990-81	SHORT CHIP			
R5823	1-218-941-81	RES-CHIP	100	5%	1/16W	R5881	1-218-961-11	RES-CHIP	4.7K	5%	1/16W
R5824	1-218-941-81	RES-CHIP	100	5%	1/16W	R5882	1-218-965-11	RES-CHIP	10K	5%	1/16W
R5825	1-208-697-11	METAL CHIP	3.9K	0.50%	1/16W	R5883	1-220-876-81	METAL CHIP	18	0.50%	1/16W
R5826	1-208-697-11	METAL CHIP	3.9K	0.50%	1/16W	R5884	1-208-687-11	METAL CHIP	1.5K	0.50%	1/16W
R5827	1-208-697-11	METAL CHIP	3.9K	0.50%	1/16W	R5885	1-208-675-11	METAL CHIP	470	0.50%	1/16W
R5829	1-218-941-81	RES-CHIP	100	5%	1/16W	R5886	1-208-647-11	METAL CHIP	33	0.50%	1/16W
R5830	1-218-973-11	RES-CHIP	47K	5%	1/16W	R5887	1-208-679-11	METAL CHIP	680	0.50%	1/16W
R5831	1-218-929-11	RES-CHIP	10	5%	1/16W	R5888	1-208-697-11	METAL CHIP	3.9K	0.50%	1/16W
R5832	1-218-929-11	RES-CHIP	10	5%	1/16W	R5889	1-208-697-11	METAL CHIP	3.9K	0.50%	1/16W
R5833	1-218-929-11	RES-CHIP	10	5%	1/16W	R5890	1-218-948-11	RES-CHIP	390	5%	1/16W
R5834	1-218-929-11	RES-CHIP	10	5%	1/16W	R5892	1-218-933-11	RES-CHIP	22	5%	1/16W
R5835	1-218-929-11	RES-CHIP	10	5%	1/16W	R5893	1-218-937-11	RES-CHIP	47	5%	1/16W
R5836	1-218-929-11	RES-CHIP	10	5%	1/16W	R5894	1-218-937-11	RES-CHIP	47	5%	1/16W
R5837	1-218-929-11	RES-CHIP	10	5%	1/16W	R5895	1-218-937-11	RES-CHIP	47	5%	1/16W
R5838	1-218-929-11	RES-CHIP	10	5%	1/16W	R5896	1-218-937-11	RES-CHIP	47	5%	1/16W
R5839	1-218-937-11	RES-CHIP	47	5%	1/16W	R5900	1-218-965-11	RES-CHIP	10K	5%	1/16W



REF. NO.	PART NO.	DESCRIPTION	VALUES			REF. NO.	PART NO.	DESCRIPTION	VALUES		
R5901	1-218-965-11	RES-CHIP	10K	5%	1/16W	R7037	1-218-990-81	SHORT CHIP			
R5902	1-218-965-11	RES-CHIP	10K	5%	1/16W	R7038	1-208-713-11	METAL CHIP	18K	0.50%	1/16W
R5903	1-218-965-11	RES-CHIP	10K	5%	1/16W	R7039	1-218-990-81	SHORT CHIP			
R5904	1-218-965-11	RES-CHIP	10K	5%	1/16W	R7041	1-218-965-11	RES-CHIP	10K	5%	1/16W
R5907	1-218-990-81	SHORT CHIP				R7043	1-208-713-11	METAL CHIP	18K	0.50%	1/16W
R5908	1-218-990-81	SHORT CHIP				R7044	1-218-990-81	SHORT CHIP			
R5909	1-218-990-81	SHORT CHIP				R7045	1-218-941-81	RES-CHIP	100	5%	1/16W
R5910	1-218-990-81	SHORT CHIP				R7046	1-216-295-91	SHORT CHIP			
R7000	1-218-871-11	METAL CHIP	10K	0.50%	1/10W	R7048	1-216-864-11	SHORT CHIP			
R7001	1-218-871-11	METAL CHIP	10K	0.50%	1/10W	R7050	1-216-825-11	METAL CHIP	2.2K	5%	1/10W
R7002	1-218-875-11	METAL CHIP	15K	0.50%	1/10W	R7051	1-218-839-11	METAL CHIP	470	0.50%	1/10W
R7003	1-218-867-11	METAL CHIP	6.8K	0.50%	1/10W	R7053	1-218-859-11	METAL CHIP	3.3K	0.50%	1/10W
R7004	1-216-841-11	METAL CHIP	47K	5%	1/10W	R7054	1-218-843-11	METAL CHIP	680	0.50%	1/10W
R7005	1-218-871-11	METAL CHIP	10K	0.50%	1/10W	R7055	1-218-867-11	METAL CHIP	6.8K	0.50%	1/10W
R7006	1-218-895-11	METAL CHIP	100K	0.50%	1/10W	R7056	1-218-867-11	METAL CHIP	6.8K	0.50%	1/10W
R7007	1-218-881-11	METAL CHIP	27K	0.50%	1/10W	R7057	1-216-843-11	METAL CHIP	68K	5%	1/10W
R7008	1-218-891-11	METAL CHIP	68K	0.50%	1/10W	R7058	1-216-851-11	METAL CHIP	330K	5%	1/10W
R7009	1-216-841-11	METAL CHIP	47K	5%	1/10W	R7060	1-208-911-11	METAL CHIP	10K	0.50%	1/16W
R7010	1-218-875-11	METAL CHIP	15K	0.50%	1/10W	R7063	1-208-911-11	METAL CHIP	10K	0.50%	1/16W
R7011	1-218-879-11	METAL CHIP	22K	0.50%	1/10W	R7064	1-216-864-11	SHORT CHIP			
R7012	1-216-835-11	METAL CHIP	15K	5%	1/10W	R7066	1-208-711-11	METAL CHIP	15K	0.50%	1/16W
R7013	1-218-882-11	METAL CHIP	30K	0.50%	1/10W	R7067	1-208-911-11	METAL CHIP	10K	0.50%	1/16W
R7014	1-218-937-11	RES-CHIP	47	5%	1/16W	R7080	1-218-990-81	SHORT CHIP			
R7015	1-218-937-11	RES-CHIP	47	5%	1/16W	R7082	1-218-875-11	METAL CHIP	15K	0.50%	1/10W
R7016	1-216-295-91	SHORT CHIP				R7083	1-218-863-11	METAL CHIP	4.7K	0.50%	1/10W
R7017	1-218-961-11	RES-CHIP	4.7K	5%	1/16W	R7085	1-208-909-11	METAL CHIP	8.2K	0.50%	1/16W
R7018	1-216-845-11	METAL CHIP	100K	5%	1/10W	R7087	1-218-967-11	RES-CHIP	15K	5%	1/16W
R7019	1-216-835-11	METAL CHIP	15K	5%	1/10W	R7090	1-218-978-11	RES-CHIP	120K	5%	1/16W
R7020	1-216-864-11	SHORT CHIP				R7091	1-208-929-81	METAL CHIP	56K	0.50%	1/16W
R7021	1-216-837-11	METAL CHIP	22K	5%	1/10W	R7092	1-218-963-11	RES-CHIP	6.8K	5%	1/16W
R7022	1-216-864-11	SHORT CHIP				R7093	1-216-295-91	SHORT CHIP			
R7023	1-216-864-11	SHORT CHIP				R7094	1-216-864-11	SHORT CHIP			
R7024	1-216-837-11	METAL CHIP	22K	5%	1/10W	R7095	1-216-864-11	SHORT CHIP			
R7025	1-216-864-11	SHORT CHIP				R7096	1-216-864-11	SHORT CHIP			
R7026	1-216-864-11	SHORT CHIP				R7097	1-216-295-91	SHORT CHIP			
R7027	1-218-990-81	SHORT CHIP				R7098	1-216-295-91	SHORT CHIP			
R7028	1-208-933-11	METAL CHIP	82K	0.50%	1/16W	R7099	1-216-295-91	SHORT CHIP			
R7029	1-208-935-11	METAL CHIP	100K	0.50%	1/16W	R7100	1-216-295-91	SHORT CHIP			
R7030	1-208-943-11	METAL CHIP	220K	0.50%	1/16W	R7101	1-216-864-11	SHORT CHIP			
R7031	1-218-971-11	RES-CHIP	33K	5%	1/16W	R7102	1-216-864-11	SHORT CHIP			
R7032	1-218-990-81	SHORT CHIP				R7103	1-216-864-11	SHORT CHIP			
R7033	1-218-990-81	SHORT CHIP				R7104	1-216-864-11	SHORT CHIP			
R7034	1-218-990-81	SHORT CHIP				R7105	1-218-973-11	RES-CHIP	47K	5%	1/16W
R7035	1-218-990-81	SHORT CHIP				R7106	1-208-911-11	METAL CHIP	10K	0.50%	1/16W
R7036	1-218-990-81	SHORT CHIP				R7107	1-208-911-11	METAL CHIP	10K	0.50%	1/16W



REF. NO.	PART NO.	DESCRIPTION	VALUES	REF. NO.	PART NO.	DESCRIPTION	VALUES
R7108	1-208-911-11	METAL CHIP	10K 0.50% 1/16W	RB5511	1-234-702-11	RES, NETWORK 68	(1005X4)
R7109	1-218-973-11	RES-CHIP	47K 5% 1/16W	RB5516	1-234-702-11	RES, NETWORK 68	(1005X4)
R7110	1-216-864-11	SHORT CHIP		RB5517	1-234-702-11	RES, NETWORK 68	(1005X4)
R7111	1-216-864-11	SHORT CHIP		RB5518	1-234-702-11	RES, NETWORK 68	(1005X4)
R7112	1-218-849-11	METAL CHIP	1.2K 0.50% 1/10W	RB5519	1-234-702-11	RES, NETWORK 68	(1005X4)
R7119	1-218-990-81	SHORT CHIP		RB5520	1-234-702-11	RES, NETWORK 68	(1005X4)
RESISTOR BRIDGE				RB5521	1-234-702-11	RES, NETWORK 68	(1005X4)
RB4007	1-234-378-21	RES, NETWORK 10K	(1005X4)	RB5522	1-234-702-11	RES, NETWORK 68	(1005X4)
RB4008	1-234-378-21	RES, NETWORK 10K	(1005X4)	RB5523	1-234-702-11	RES, NETWORK 68	(1005X4)
RB4014	1-234-371-21	RES, NETWORK 47	(1005X4)	RB5800	1-242-963-21	RES, NETWORK 33	(1005X4)
RB4015	1-234-371-21	RES, NETWORK 47	(1005X4)	RB5801	1-234-371-21	RES, NETWORK 47	(1005X4)
RB4016	1-234-371-21	RES, NETWORK 47	(1005X4)	RB5802	1-234-371-21	RES, NETWORK 47	(1005X4)
RB4018	1-234-371-21	RES, NETWORK 47	(1005X4)	RB5803	1-234-371-21	RES, NETWORK 47	(1005X4)
RB4019	1-234-371-21	RES, NETWORK 47	(1005X4)	RB5804	1-234-371-21	RES, NETWORK 47	(1005X4)
RB4020	1-234-371-21	RES, NETWORK 47	(1005X4)	RB5805	1-234-371-21	RES, NETWORK 47	(1005X4)
RB4700	1-234-372-11	RES, NETWORK 100	(1005X4)	RB5806	1-234-371-21	RES, NETWORK 47	(1005X4)
RB4702	1-234-372-11	RES, NETWORK 100	(1005X4)	RB5807	1-234-378-21	RES, NETWORK 10K	(1005X4)
RB4703	1-234-372-11	RES, NETWORK 100	(1005X4)	RB5808	1-234-378-21	RES, NETWORK 10K	(1005X4)
RB4704	1-234-372-11	RES, NETWORK 100	(1005X4)	RB5809	1-234-378-21	RES, NETWORK 10K	(1005X4)
RB4705	1-234-372-11	RES, NETWORK 100	(1005X4)	RB5810	1-234-378-21	RES, NETWORK 10K	(1005X4)
RB4707	1-234-379-21	RES, NETWORK 22K	(1005X4)	RB5811	1-234-378-21	RES, NETWORK 10K	(1005X4)
RB4708	1-234-379-21	RES, NETWORK 22K	(1005X4)	RB5812	1-234-378-21	RES, NETWORK 10K	(1005X4)
RB4709	1-234-379-21	RES, NETWORK 22K	(1005X4)	VARISTOR			
RB4710	1-234-379-21	RES, NETWORK 22K	(1005X4)	VD4400	1-802-078-11	VARISTOR	(SMD)
RB4712	1-234-379-21	RES, NETWORK 22K	(1005X4)	VD4401	1-802-078-11	VARISTOR	(SMD)
RB5000	1-234-372-11	RES, NETWORK 100	(1005X4)	VD4402	1-802-078-11	VARISTOR	(SMD)
RB5001	1-234-372-11	RES, NETWORK 100	(1005X4)	VD4403	1-802-078-11	VARISTOR	(SMD)
RB5002	1-234-372-11	RES, NETWORK 100	(1005X4)	VD4404	1-802-078-11	VARISTOR	(SMD)
RB5003	1-234-372-11	RES, NETWORK 100	(1005X4)	VD4405	1-802-078-11	VARISTOR	(SMD)
RB5004	1-234-372-11	RES, NETWORK 100	(1005X4)	VD4406	1-802-078-11	VARISTOR	(SMD)
RB5005	1-234-377-21	RES, NETWORK 4.7K	(1005X4)	VD5801	1-802-078-11	VARISTOR	(SMD)
RB5006	1-234-377-21	RES, NETWORK 4.7K	(1005X4)	VD5802	1-802-078-11	VARISTOR	(SMD)
RB5007	1-234-377-21	RES, NETWORK 4.7K	(1005X4)	VD5803	6-500-701-01	DIODE	PGB1010603NR
RB5212	1-234-377-21	RES, NETWORK 4.7K	(1005X4)	VD5804	6-500-701-01	DIODE	PGB1010603NR
RB5213	1-234-377-21	RES, NETWORK 4.7K	(1005X4)	VD5805	6-500-701-01	DIODE	PGB1010603NR
RB5501	1-234-370-21	RES, NETWORK 22	(1005X4)	VD5806	6-500-701-01	DIODE	PGB1010603NR
RB5502	1-234-370-21	RES, NETWORK 22	(1005X4)	VD5807	6-500-701-01	DIODE	PGB1010603NR
RB5503	1-234-370-21	RES, NETWORK 22	(1005X4)	VD5808	6-500-701-01	DIODE	PGB1010603NR
RB5504	1-234-702-11	RES, NETWORK 68	(1005X4)	VD5809	6-500-701-01	DIODE	PGB1010603NR
RB5505	1-234-702-11	RES, NETWORK 68	(1005X4)	VD5810	6-500-701-01	DIODE	PGB1010603NR
RB5506	1-234-702-11	RES, NETWORK 68	(1005X4)	VD5811	6-500-701-01	DIODE	PGB1010603NR
RB5507	1-234-702-11	RES, NETWORK 68	(1005X4)	VD5812	6-500-701-01	DIODE	PGB1010603NR
RB5508	1-234-702-11	RES, NETWORK 68	(1005X4)	VD5813	6-500-701-01	DIODE	PGB1010603NR
RB5509	1-234-702-11	RES, NETWORK 68	(1005X4)				
RB5510	1-234-702-11	RES, NETWORK 68	(1005X4)				

NOTE: The components identified by shading and \triangle mark are critical for safety. Replace only with part number specified.

NOTE: Les composants identifiés par un trame et une marque \triangle sont critiques pour la sécurité. Ne les remplacer que par une pièce portant le numéro spécifié.

REF. NO.	PART NO.	DESCRIPTION	VALUES	REF. NO.	PART NO.	DESCRIPTION	VALUES	
CONNECTOR								
	CN6000	1-695-915-11	TAB (CONTACT)	D6456	8-719-404-50	DIODE	MA111-TX	
* \triangle	CN6001	1-793-660-11	PIN, CONNECTOR (PC BOARD)	3P	D6504	8-719-404-50	DIODE	MA111-TX
	CN6011	1-537-770-21	TERMINAL BOARD, GROUND	D6505	8-719-421-82	DIODE	MA8043-M	
*	CN6200	1-793-236-11	PIN, CONNECTOR (PC BOARD)	14P	D6506	8-719-054-59	DIODE	FSF05A60
*	CN6202	1-785-708-11	PIN, CONNECTOR (PC BOARD)	12P	D6507	8-719-404-50	DIODE	MA111-TX
	CN6204	1-785-706-11	PIN, CONNECTOR (PC BOARD)	10P	D6508	6-500-108-01	DIODE	EP05FA20
	CN6206	1-695-915-11	TAB (CONTACT)	D6509	6-500-108-01	DIODE	EP05FA20	
	CN6207	1-695-915-11	TAB (CONTACT)	D6510	6-500-137-01	DIODE	BAT54HT1	
	CN6211	1-537-770-21	TERMINAL BOARD, GROUND	D6511	8-719-404-50	DIODE	MA111-TX	
	CN6214	1-537-770-21	TERMINAL BOARD, GROUND	D6512	8-719-404-50	DIODE	MA111-TX	
	CN6216	1-537-770-21	TERMINAL BOARD, GROUND	D6551	8-719-404-50	DIODE	MA111-TX	
*	CN6217	1-785-701-11	PIN, CONNECTOR (PC BOARD)	3P	D6552	8-719-404-50	DIODE	MA111-TX
				D6553	8-719-404-50	DIODE	MA111-TX	
DIODE				FUSE				
	D6000	8-719-054-89	DIODE	D15XB60	\triangle F6000	1-576-233-51	FUSE	6.3A 250V
	D6002	8-719-404-50	DIODE	MA111-TX	FERRITE BEAD			
	D6003	8-719-404-50	DIODE	MA111-TX	FB6100	1-412-911-11	FERRITE	0 μ H
	D6102	6-500-137-01	DIODE	BAT54HT1	FB6101	1-412-911-11	FERRITE	0 μ H
	D6103	8-719-979-64	DIODE	UF4005/23	IC			
	D6104	6-501-043-01	DIODE	UMZ16NT106	\triangle IC6100	6-707-749-01	IC	CXD9841P
\triangle	D6105	6-501-043-01	DIODE	UMZ16NT106	IC6200	6-709-368-01	IC	MM1431ATT (CN)
	D6106	8-719-081-67	DIODE	M1FM3	\triangle IC6301	6-708-801-01	IC	MIP2H2
\triangle	D6107	8-719-081-67	DIODE	M1FM3	IC6302	6-709-442-01	IC	MM1530ATT
	D6108	8-719-041-97	DIODE	MA113-(TX)	IC6401	6-709-368-01	IC	MM1431ATT (CN)
	D6109	8-719-022-90	DIODE	MA8160-M	IC6402	6-709-368-01	IC	MM1431ATT (CN)
	D6200	8-719-057-96	DIODE	D10SC6M-4012	\triangle IC6502	6-709-192-01	IC	FA5501AN-D1-TE1
	D6201	8-719-057-96	DIODE	D10SC6M-4012	CHIP CONDUCTOR			
	D6202	8-719-057-96	DIODE	D10SC6M-4012	JR6001	1-216-295-91	SHORT CHIP	
	D6203	8-719-057-96	DIODE	D10SC6M-4012	JR6002	1-216-296-11	SHORT CHIP	
	D6204	6-500-567-31	DIODE	10ERB20-TB3	JR6004	1-216-295-91	SHORT CHIP	
	D6205	6-500-567-31	DIODE	10ERB20-TB3	JR6005	1-216-296-11	SHORT CHIP	
	D6207	8-719-057-96	DIODE	D10SC6M-4012	JR6006	1-216-296-11	SHORT CHIP	
	D6208	8-719-057-96	DIODE	D10SC6M-4012	JR6007	1-216-296-11	SHORT CHIP	
	D6302	6-500-567-31	DIODE	10ERB20-TB3	JR6008	1-216-296-11	SHORT CHIP	
	D6303	6-500-567-31	DIODE	10ERB20-TB3	JR6009	1-216-296-11	SHORT CHIP	
	D6304	6-500-849-01	DIODE	ERA22-08KFLB	JR6010	1-216-296-11	SHORT CHIP	
	D6305	6-500-567-31	DIODE	10ERB20-TB3	JR6011	1-216-295-91	SHORT CHIP	
	D6306	8-719-510-02	DIODE	D1NS4	JR6012	1-216-295-91	SHORT CHIP	
	D6401	8-719-404-50	DIODE	MA111-TX	JR6013	1-216-296-11	SHORT CHIP	
	D6402	8-719-404-50	DIODE	MA111-TX	JR6014	1-216-296-11	SHORT CHIP	
	D6406	8-719-404-50	DIODE	MA111-TX				
	D6407	8-719-018-01	DIODE	MA8220-TX				
	D6408	8-719-404-50	DIODE	MA111-TX				
	D6452	8-719-404-50	DIODE	MA111-TX				

NOTE: The components identified by shading and \triangle mark are critical for safety. Replace only with part number specified.

NOTE: Les composants identifiés par un trame et une marque \triangle sont critiques pour la sécurité. Ne les remplacer que par une pièce portant le numéro spécifié.

REF. NO.	PART NO.	DESCRIPTION	VALUES	REF. NO.	PART NO.	DESCRIPTION	VALUES
COIL				R6101	1-249-385-11	CARBON	2.2 5% 1/4W
L6000	1-456-856-21	LINE FILTER COIL		\triangle R6102	1-202-933-61	FUSIBLE	0.1 10% 1/2W
L6203	1-414-487-41	INDUCTOR	1 μ H	R6103	1-218-823-11	METAL CHIP	100 0.50% 1/10W
L6204	1-414-487-41	INDUCTOR	1 μ H	R6104	1-218-887-11	METAL CHIP	47K 0.50% 1/10W
L6207	1-457-239-11	INDUCTOR	4.7 μ H	R6105	1-208-854-11	METAL CHIP	1M 0.50% 1/10W
L6208	1-457-239-11	INDUCTOR	4.7 μ H	R6106	1-208-854-11	METAL CHIP	1M 0.50% 1/10W
L6300	1-414-183-41	INDUCTOR	10 μ H	R6107	1-208-854-11	METAL CHIP	1M 0.50% 1/10W
L6500	1-457-218-11	INDUCTOR	100 μ H	R6108	1-208-854-11	METAL CHIP	1M 0.50% 1/10W
L6502	1-457-141-21	INDUCTOR	175 μ H	R6109	1-218-761-11	METAL CHIP	240K 0.50% 1/10W
PHOTO COUPLER				R6110	1-218-881-11	METAL CHIP	27K 0.50% 1/10W
PH6000	6-600-187-01	PHOTO COUPLER	PC123Y22JOOF	R6111	1-218-873-11	METAL CHIP	12K 0.50% 1/10W
PH6100	6-600-187-01	PHOTO COUPLER	PC123Y22JOOF	R6114	1-211-985-11	METAL CHIP	47 0.50% 1/10W
PH6301	6-600-187-01	PHOTO COUPLER	PC123Y22JOOF	R6116	1-216-009-91	RES-CHIP	22 5% 1/10W
PH6400	6-600-187-01	PHOTO COUPLER	PC123Y22JOOF	R6117	1-216-009-91	RES-CHIP	22 5% 1/10W
PH6401	6-600-187-01	PHOTO COUPLER	PC123Y22JOOF	R6118	1-216-833-11	METAL CHIP	10K 5% 1/10W
PH6402	6-600-187-01	PHOTO COUPLER	PC123Y22JOOF	R6119	1-216-833-11	METAL CHIP	10K 5% 1/10W
TRANSISTOR				R6121	1-216-361-00	METAL OXIDE	0.22 5% 2W
Q6051	8-729-045-62	TRANSISTOR	2SK2158-T2B	R6122	1-216-361-00	METAL OXIDE	0.22 5% 2W
\triangle Q6100	6-551-297-01	TRANSISTOR	2SK3568(LBS1SONY.Q	R6123	1-218-847-11	METAL CHIP	1K 0.50% 1/10W
\triangle Q6101	6-551-297-01	TRANSISTOR	2SK3568(LBS1SONY.Q	R6127	1-216-857-11	METAL CHIP	1M 5% 1/10W
Q6400	8-729-804-41	TRANSISTOR	2SB1122-S	R6200	1-216-821-11	METAL CHIP	1K 5% 1/10W
Q6401	8-729-120-28	TRANSISTOR	2SC1623-L5L6	R6201	1-216-821-11	METAL CHIP	1K 5% 1/10W
Q6402	8-729-045-62	TRANSISTOR	2SK2158-T2B	R6202	1-216-105-91	RES-CHIP	220K 5% 1/10W
Q6403	8-729-600-22	TRANSISTOR	2SA1235-F	R6203	1-216-829-11	METAL CHIP	4.7K 5% 1/10W
Q6404	8-729-120-28	TRANSISTOR	2SC1623-L5L6	R6204	1-218-843-11	METAL CHIP	680 0.50% 1/10W
Q6405	8-729-120-28	TRANSISTOR	2SC1623-L5L6	R6205	1-218-865-11	METAL CHIP	5.6K 0.50% 1/10W
Q6406	8-729-120-28	TRANSISTOR	2SC1623-L5L6	R6207	1-218-847-11	METAL CHIP	1K 0.50% 1/10W
Q6408	8-729-120-28	TRANSISTOR	2SC1623-L5L6	\triangle R6208	1-249-377-11	CARBON	0.47 5% 1/4W
Q6409	8-729-120-28	TRANSISTOR	2SC1623-L5L6	R6226	1-249-389-11	CARBON	4.7 5% 1/4W
Q6454	8-729-600-22	TRANSISTOR	2SA1235-F	\triangle R6300	1-212-958-00	FUSIBLE	10 5% 1/2W
Q6455	8-729-120-28	TRANSISTOR	2SC1623-L5L6	R6301	1-243-725-71	METAL OXIDE	100K 5% 1W
\triangle Q6500	6-551-403-01	TRANSISTOR	2SK3797(LBS1SONY.	R6302	1-218-865-11	METAL CHIP	5.6K 0.50% 1/10W
Q6501	8-729-820-90	TRANSISTOR	2SD1621-ST	R6303	1-249-385-11	CARBON	2.2 5% 1/4W
Q6502	8-729-804-41	TRANSISTOR	2SB1122-S	R6304	1-216-821-11	METAL CHIP	1K 5% 1/10W
\triangle Q6504	6-551-403-01	TRANSISTOR	2SK3797(LBS1SONY.	R6305	1-216-827-11	METAL CHIP	3.3K 5% 1/10W
RESISTOR				R6306	1-216-805-11	METAL CHIP	47 5% 1/10W
\triangle R6002	1-240-251-11	METAL	6.8 5% 10W	R6307	1-218-887-11	METAL CHIP	47K 0.50% 1/10W
R6003	1-247-752-11	CARBON	1K 5% 1/2W	R6308	1-218-871-11	METAL CHIP	10K 0.50% 1/10W
R6004	1-218-835-11	METAL CHIP	330 0.50% 1/10W	R6309	1-218-867-11	METAL CHIP	6.8K 0.50% 1/10W
R6051	1-216-821-11	METAL CHIP	1K 5% 1/10W	R6400	1-216-833-11	METAL CHIP	10K 5% 1/10W
R6052	1-216-837-11	METAL CHIP	22K 5% 1/10W	R6401	1-218-863-11	METAL CHIP	4.7K 0.50% 1/10W
				R6402	1-216-833-11	METAL CHIP	10K 5% 1/10W
				R6403	1-218-887-11	METAL CHIP	47K 0.50% 1/10W
				R6405	1-216-829-11	METAL CHIP	4.7K 5% 1/10W
				R6407	1-216-837-11	METAL CHIP	22K 5% 1/10W

H1U H2U H3U

REF. NO.	PART NO.	DESCRIPTION	VALUES		
H1U					
*	A-1196-570-A	H1U BOARD, MOUNTED			
<u>CONNECTOR</u>					
CN1101	1-819-445-11	HEADER ASSEMBLY FOR PWB			
<u>RESISTOR</u>					
R1101	1-218-848-11	METAL CHIP	1.1K	0.50%	1/10W
R1102	1-218-841-11	METAL CHIP	560	0.50%	1/10W
R1103	1-218-835-11	METAL CHIP	330	0.50%	1/10W
R1104	1-218-831-11	METAL CHIP	220	0.50%	1/10W
R1105	1-218-827-11	METAL CHIP	150	0.50%	1/10W
<u>SWITCH</u>					
S1101	1-572-595-11	SWITCH, TACTIL (REFLOW TYPE)			
S1102	1-572-595-11	SWITCH, TACTIL (REFLOW TYPE)			
S1103	1-572-595-11	SWITCH, TACTIL (REFLOW TYPE)			
S1104	1-572-595-11	SWITCH, TACTIL (REFLOW TYPE)			
S1105	1-572-595-11	SWITCH, TACTIL (REFLOW TYPE)			
S1106	1-572-595-11	SWITCH, TACTIL (REFLOW TYPE)			
S1107	1-572-595-11	SWITCH, TACTIL (REFLOW TYPE)			

REF. NO.	PART NO.	DESCRIPTION	VALUES		
H2U					
*	A-1196-571-A	H2U BOARD, MOUNTED			
<u>CAPACITOR</u>					
C1203	1-127-573-11	CERAMIC CHIP	1μF	10%	16V
C1204	1-127-573-11	CERAMIC CHIP	1μF	10%	16V
C1205	1-125-891-11	CERAMIC CHIP	0.47μF	10%	10V
C1206	1-125-889-91	CERAMIC CHIP	2.2μF	10%	10V
C1207	1-125-889-91	CERAMIC CHIP	2.2μF	10%	10V
C1208	1-125-889-91	CERAMIC CHIP	2.2μF	10%	10V
C1215	1-115-416-11	CERAMIC CHIP	0.001μF	5%	25V
<u>CONNECTOR</u>					
CN1201	1-820-192-11	HEADER ASSEMBLY (PRINT PWB)	15P		
<u>DIODE</u>					
D1201	8-719-423-03	DIODE	MA8100		
D1202	8-719-423-03	DIODE	MA8100		
D1203	8-719-423-03	DIODE	MA8100		
D1204	8-719-423-03	DIODE	MA8100		
D1205	8-719-423-03	DIODE	MA8100		
D1206	8-719-423-03	DIODE	MA8100		

REF. NO.	PART NO.	DESCRIPTION	VALUES		
<u>JACK</u>					
J1201	1-780-368-11	S TERMINAL BLOCK (RIGHT)			
J1202	1-815-325-11	JACK			
<u>RESISTOR</u>					
R1202	1-216-864-11	SHORT CHIP			
R1203	1-216-853-11	METAL CHIP	470K	5%	1/10W
R1204	1-216-853-11	METAL CHIP	470K	5%	1/10W
R1205	1-216-864-11	SHORT CHIP			
R1206	1-216-864-11	SHORT CHIP			
R1207	1-218-831-11	METAL CHIP	220	0.50%	1/10W
R1208	1-218-831-11	METAL CHIP	220	0.50%	1/10W
R1209	1-218-285-11	METAL CHIP	75	5%	1/10W
R1210	1-218-831-11	METAL CHIP	220	0.50%	1/10W
R1211	1-218-831-11	METAL CHIP	220	0.50%	1/10W
R1212	1-216-864-11	SHORT CHIP			
R1213	1-216-821-11	METAL CHIP	1K	5%	1/10W
R1214	1-216-821-11	METAL CHIP	1K	5%	1/10W
R1215	1-216-864-11	SHORT CHIP			
R1216	1-216-864-11	SHORT CHIP			
R1217	1-216-821-11	METAL CHIP	1K	5%	1/10W
R1218	1-216-821-11	METAL CHIP	1K	5%	1/10W
R1219	1-216-809-11	METAL CHIP	100	5%	1/10W
R1220	1-216-864-11	SHORT CHIP			
R1224	1-218-831-11	METAL CHIP	220	0.50%	1/10W
R1225	1-218-831-11	METAL CHIP	220	0.50%	1/10W
<u>VARISTOR</u>					
VD1201	1-802-082-11	VARISTOR	(SMD)		
VD1202	1-802-082-11	VARISTOR	(SMD)		
VD1203	1-802-082-11	VARISTOR	(SMD)		

REF. NO.	PART NO.	DESCRIPTION	VALUES		
H3U					
*	A-1196-572-A	H3U BOARD, MOUNTED			
<u>CAPACITOR</u>					
C1302	1-162-960-11	CERAMIC CHIP	220pF	10%	50V
C1303	1-119-667-11	CERAMIC CHIP	22μF	10V	
C1305	1-165-908-11	CERAMIC CHIP	1μF	10%	10V
C1307	1-107-826-11	CERAMIC CHIP	0.1μF	10%	16V
C1308	1-126-205-11	ELECT CHIP	47μF	20%	6.3V
<u>CONNECTOR</u>					
CN1301	1-820-187-11	HEADER ASSEMBLY (PRINT PWB)	10P		



REF. NO.	PART NO.	DESCRIPTION	VALUES
DIODE			
D1302	8-719-085-26	DIODE	CL-165HR/SYG-D-T
D1305	8-719-085-26	DIODE	CL-165HR/SYG-D-T
D1308	6-500-817-01	DIODE	(LED) SML-512UWT86
IC			
IC1301	6-600-502-01	HIC	GP1UE26RK0VF
IC1302	6-600-447-01	IC	TPS853(SONY)
TRANSISTOR			
Q1301	8-729-028-96	TRANSISTOR	DTC114EUA-T106
Q1302	8-729-028-96	TRANSISTOR	DTC114EUA-T106
Q1303	8-729-028-96	TRANSISTOR	DTC114EUA-T106
Q1304	8-729-028-96	TRANSISTOR	DTC114EUA-T106
Q1305	8-729-028-96	TRANSISTOR	DTC114EUA-T106
Q1306	8-729-602-36	TRANSISTOR	2SA1602-F
RESISTOR			
R1301	1-216-815-11	METAL CHIP	330 5% 1/10W
R1302	1-216-811-11	METAL CHIP	150 5% 1/10W
R1303	1-216-815-11	METAL CHIP	330 5% 1/10W
R1304	1-216-811-11	METAL CHIP	150 5% 1/10W
R1305	1-216-821-11	METAL CHIP	1K 5% 1/10W
R1306	1-216-817-11	METAL CHIP	470 5% 1/10W
R1307	1-216-805-11	METAL CHIP	47 5% 1/10W
R1309	1-216-839-11	METAL CHIP	33K 5% 1/10W
R1310	1-216-821-11	METAL CHIP	1K 5% 1/10W
R1311	1-216-833-11	METAL CHIP	10K 5% 1/10W
R1313	1-216-849-11	METAL CHIP	220K 5% 1/10W
R1314	1-216-849-11	METAL CHIP	220K 5% 1/10W
R1315	1-216-864-11	SHORT CHIP	
R1316	1-216-827-11	METAL CHIP	3.3K 5% 1/10W



A-1164-341-B QT BOARD, COMPLETE

Due to the complexity of this board, performing component level field repairs is not recommended. If service is required, complete board replacement is the preferred repair method.

(If the tuner needs to be replaced, the complete QT Board must be ordered. It cannot be ordered seperately.)



A-1219-286-A QSF BOARD, COMPLETE

Due to the complexity of this board, performing component level field repairs is not recommended. If service is required, complete board replacement is the preferred repair method.

NOTE: The components identified by shading and  mark are critical for safety. Replace only with part number specified.

NOTE: Les composants identifiés par un trame et une marque  sont critiques pour la sécurité. Ne les remplacer que par une pièce portant le numéro spécifique.

REF. NO.	PART NO.	DESCRIPTION	VALUES	REF. NO.	PART NO.	DESCRIPTION	VALUES
<u>ACCESSORIES AND PACKING</u>							
	1-832-937-11	AC POWER-SUPPLY CORD SET		*	X-2055-089-2	LOCK ASSY, RUDDER	
	A-1196-574-A	ACCESSORY ASSY (KDL-40V2500 ONLY)			2-697-121-11	MANUAL, INSTRUCTION (ENGLISH VERSION) (KDL-40V2500/46V2500 ONLY)	
	A-1196-578-A	ACCESSORY ASSY (KDL-46V2500 ONLY)			2-894-183-11	MANUAL, INSTRUCTION (ENGLISH VERSION) (KDL-46V25L1 ONLY)	
	X-2102-511-2	BAG ASSY, RUDDER LOCK (Contains the Support Belt)			2-697-121-21	MANUAL, INSTRUCTION (FRENCH VERSION) (KDL-40V2500/46V2500 ONLY)	
*	2-678-265-01	BAG, PROTECTION (KDL-40V2500 ONLY)			2-593-320-02	SCREW, CION (M6X18)	
*	2-678-266-01	BAG, PROTECTION (KDL-46V2500/46V25L1 ONLY)		*	2-580-663-01	SCREW, WOOD 3.8X20	
	1-830-686-11	CABLE ASSY(15PDSUBCONNECTORX2)		*	2-697-904-01	TRAY (KDL-40V2500 ONLY)	
	1-765-167-62	CABLE, COAXIAL (WITH (F) PLUG)		*	2-886-159-01	TRAY (KDL-46V2500/46V25L1 ONLY)	
	X-2159-787-1	CARTON ASSY (KDL-46V25L1 ONLY)		*	2-697-905-01	TRAY, TOP (KDL-40V2500 ONLY)	
*	2-697-903-01	CARTON, INDIVIDUAL (KDL-40V2500 ONLY)		*	2-673-897-01	TRAY, TOP (KDL-46V2500/46V25L1 ONLY)	
*	2-697-908-01	CARTON, INDIVIDUAL (KDL-46V2500 ONLY)		<u>MISCELLANEOUS</u>			
*	2-895-881-01	CARTON, INDIVIDUAL (KDL-46V25L1 ONLY)		*	2-683-745-01	HOLDER	
*	2-697-907-01	CUSHION, LOWER (KDL-40V2500 ONLY)			2-580-602-01	SCREW, +PSW M4X12	
*	2-697-910-01	CUSHION, LOWER (KDL-46V2500/46V25L1 ONLY)			2-580-608-01	SCREW, +PSW M5X16	
*	2-697-906-01	CUSHION, UPPER (KDL-40V2500 ONLY)			2-689-511-11	SHEET, RADIATION (FIN)	
*	2-697-909-01	CUSHION, UPPER (KDL-46V2500/46V25L1 ONLY)		<u>REMOTE COMMANDER</u>			
	1-528-692-61	DRY, BATTERY CARBON-ZINC			1-479-956-11	REMOTE COMMANDER (RM-YD012)	
	2-697-122-11	GUIDE, QUICK SETUP (ENGLISH VERSION) (KDL-40V2500/46V2500 ONLY)					
	2-894-213-11	GUIDE, QUICK SETUP (ENGLISH VERSION) (KDL-46V25L1 ONLY)					
	2-697-122-21	GUIDE, QUICK SETUP (FRENCH VERSION) (KDL-40V2500/46V2500 ONLY)					