

SD

BRUNNEN

KDL32S3000

WAX3 CHASSIS

<u>MODEL NAME</u>	<u>REMOTE COMMANDER</u>	<u>DESTINATION</u>
KDL-26S3000	RM-YD018	US/CANADA
KDL-32S3000	RM-YD018	US/CANADA
KDL-40S3000	RM-YD018	US/CANADA
KDL-46S3000	RM-YD018	US/CANADA



KDL-46S3000



RM-YD018

LCD DIGITAL COLOR TELEVISION

3-5. SEMICONDUCTORS

IC

BA00AST-V5

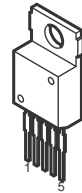

BA05FP-E2
BA09FP-E2
S-1111B33MC-NYSTFG
S-80928CNMC-G8YT2G
TC7SZ125FU(TE85R)

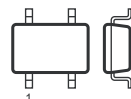

5Pin CHIP

BA18BC0FP-E2
BA25BC0FP-E2

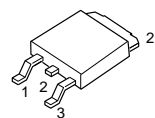

BR24L02F-WE2
CS4335-KSZR
FA5501N-TE1
LM75CIMX-3
M24128-BWMN6T(A)
M24C02-WMN6T(B)
NJM2521V(TE2)
NJM3414AV(TE2)
RC4558DR
RC4558PWR

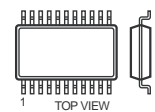

8Pin SOP

CD4052BNSR
FMS6418AM16X

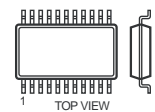

16Pin SOP

CXA2188Q-T4

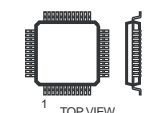

40Pin QFP

EM6A9320BI-5MG

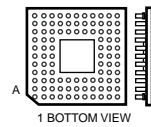

144Pin PGA

HD6433692A39FXV
HD64F3694FXV-DA4
TPA3004D2PHPR

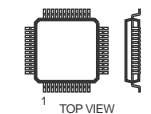

48Pin QFP

HD64F2378-12681-01

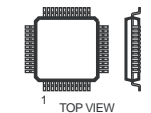

144Pin QFP

L88M05T-FA-TL

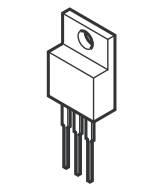

M52347FP-TE

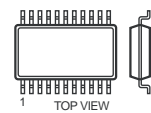

20Pin SOP

MM1431ATT

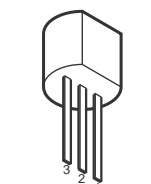

NJW1149AFH1

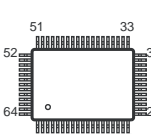

PQ1CY1032ZP

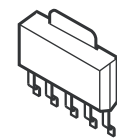

PQ1CZ41H2ZPH

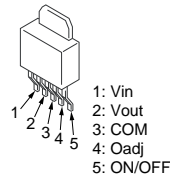

1: Vin
2: Vout
3: COM
4: Oadj
5: ON/OFF

RV5C387A-E2-FB

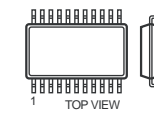

SH9993CTG100

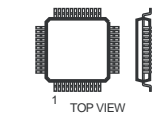

100Pin QFP

SN74LV132APWR
SN74LVC14APWR

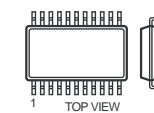

14Pin SOP

STR-A6169

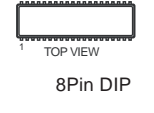

8Pin DIP

TK11819MTL

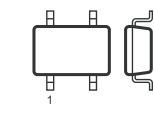

6Pin CHIP

TRANSISTOR

DTC114EU
DTC114EUAFT106

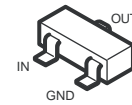

DTC114EUA-T106
DTC115EUA-T106
DTC144WKA-T146
DTC314TK-T-146
DTC323TK
DTC323TKT146
MUN2211T1
MUN2212T1
MUN5213T1
PDTC114EK-115
UN2211
2PA1576R-115
2PC4081R-115
2PD601AR-115
2SA1037AK-T146-QR
2SA1037AK-T146-R
2SA1576A-T106-QR
2SA1774R
2SA1774TL-QR
2SC1623-L5L6
2SC2412K-T-146-QR
2SC4081-R
2SC4081T106R
2SC4617R
2SC4617TL-QR
2SD2114K
2SD601A-Q-TX

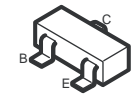

FDS6690A

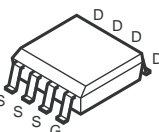

HN1B01FU-TE85R

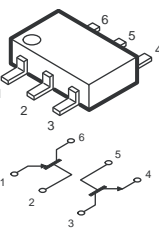

SSM6N15FU(TE85R)

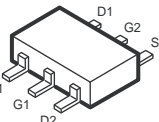

2SB1122-S
2SB1122-ST-TD-E
2SD1621-ST
2SD1621ST-TD-E

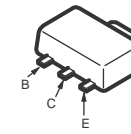

2SD2114KT146

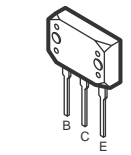

2SK2158-T2B

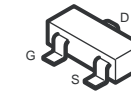

DIODE

BAS316-115
EP05FA20
MM3Z10VT1
MM3Z11VT1
MM3Z13VT1
MM3Z18VST1
MM3Z22VT1
MM3Z2V4T1
MM3Z5V6ST1
MM3Z6V2ST1
MM3Z6V8ST1
MM3Z8V2ST1

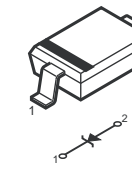

BAT54HT1
DTZ10B
HZU5.6GTRF
MA113-(TX)
MMDL914T1
RD5.6SB-T1
UDZ-TE-17-18B
UDZ-TE-17-6.2B
UDZ-TE-17-6.8B

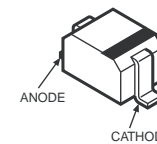

D10SBS4
D10SBS4F
D2SB60A-F04
D4SB60L

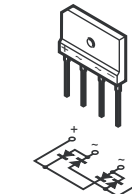

D10SC6M

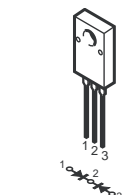

D1NL40-TA2
D1NL40-TR2
ERA22-08

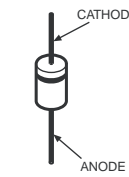

D1NS6
D1NS6-TR
ERA22-06AVRBT
UF4005PKG23
10ERB20-TB3
1N5404TU

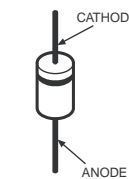

EC10QS-04
EC10QS04-TE12L5

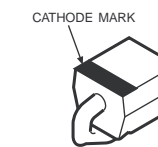

EC21QS03L-TE12L
P6SMBJ30A-5
PTZ-TE25-3.9B

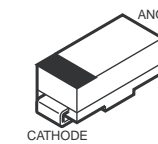

ERA22-08KFLB

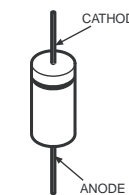

FSF05A60

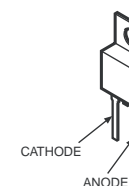

HN1D03FU-TE85L
HN1D03FU-TE85R

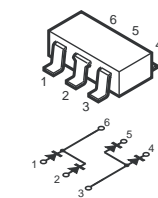

M1FM3

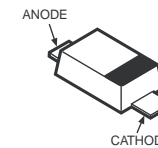

MA132WK
MA132WK-TX
MA151WK-TX
1SS184

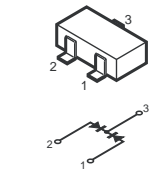

UDZSTE-1710B

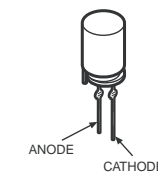

UMZ16NT106

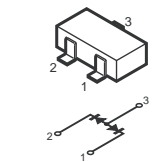

1PS302

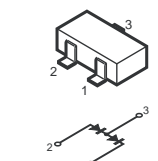

SML-020MVT-T86

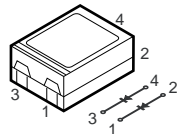

SML-310LTT86

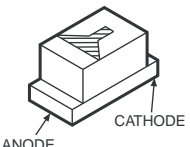



SECTION 4: EXPLODED VIEWS

Components not identified by a part number or description are not stocked because they are seldom required for routine service.

The component parts of an assembly are indicated by the reference numbers in the far right column of the parts list and within the dotted lines of the diagram.

* Items marked with an asterisk are not stocked since they are seldom required for routine service. Expect some delay when ordering these components.

NOTE: The components identified by shading and  mark are critical for safety. Replace only with part number specified.

NOTE: Les composants identifiés par un trame et une marque  sont critiques pour la sécurité. Ne les remplacer que par une pièce portant le numéro spécifié.

NOTE: The components identified by a red outline and a  mark contain confidential information. Specific instructions must be adhered to whenever these components are repaired and/or replaced. See Appendix A: Encryption Key Components in the back of this manual.

4-1. REAR COVER AND STAND ASSEMBLY

(Please review the [Sony Electronics Service Information](#) website for any additional service information.)

■	7-685-648-79	SCREW +BVTP 3X12 TYPE2 TT(B)
☆	2-580-640-01	SCREW, +BVTP2 4X16
●	2-580-608-01	SCREW, +PSW M5X16
○	2-580-607-01	SCREW, +PSW M5X12 (KDL-40S3000/46S3000 ONLY)
▲	2-580-606-01	SCREW, +PSW M5X8
▽	2-580-644-01	SCREW, +KTP2 3X8

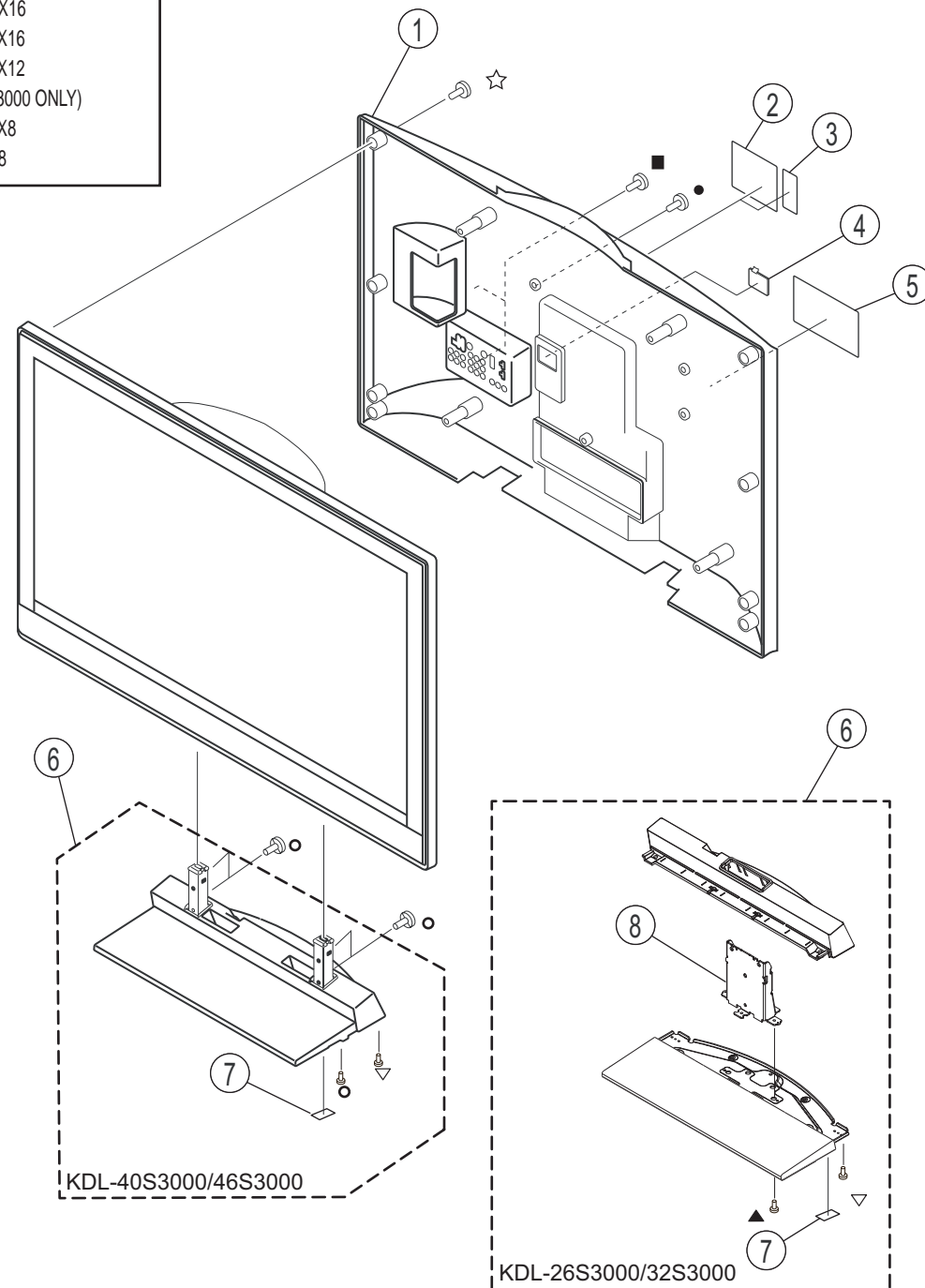

REF. NO.	PART NO.	DESCRIPTION	[ASSEMBLY INCLUDES]	REF. NO.	PART NO.	DESCRIPTION	[ASSEMBLY INCLUDES]
1	3-100-157-01	COVER, REAR (26) (KDL-26S3000 ONLY)		* 5	3-215-345-01	LABEL, INFORMATION (KDL-32S3000 ONLY)	
1	3-097-972-01	COVER, REAR (32) (KDL-32S3000 ONLY)		* 5	3-197-045-01	LABEL, INFORMATION (KDL-40S3000 ONLY)	
1	X-2179-398-1	COVER ASSEMBLY, REAR (40) (KDL-40S3000 ONLY)		* 5	3-215-344-11	LABEL, INFORMATION (KDL-46S3000 ONLY)	
1	3-098-013-01	COVER, REAR (46) (KDL-46S3000 ONLY)		* 5	3-215-344-01	LABEL, INFORMATION (KDL-46S3000 ONLY)	
1	3-098-010-01	COVER, REAR (46) (KDL-46S3000 ONLY)		6	A-1259-944-A	STAND (M_WS) ASSEMBLY (KDL-26S3000/32S3000 ONLY)	[7-8]
2	3-215-160-01	LABEL, REAR TERMINAL		6	A-1253-777-A	STAND (ML_WS) ASSEMBLY (KDL-40S3000 ONLY)	[7]
3	3-217-797-01	LABEL, HDMI		6	A-1253-776-A	STAND (L_WS) ASSEMBLY (KDL-46S3000 ONLY)	[7]
4	3-196-465-01	COVER, ECS		7	3-213-762-01	FOOT (15X30)	
* 5	3-215-346-01	LABEL, INFORMATION (KDL-26S3000 ONLY)		8	3-106-486-01	NECK (M) (KDL-26S3000/32S3000 ONLY)	

NOTE: The components identified by shading and  mark are critical for safety. Replace only with part number specified.

NOTE: Les composants identifiés par un trame et une marque  sont critiques pour la sécurité. Ne les remplacer que par une pièce portant le numéro spécifié.

NOTE: The components identified by a red outline and a  mark contain confidential information. Specific instructions must be adhered to whenever these components are repaired and/or replaced. See Appendix A: Encryption Key Components in the back of this manual.

4-2. BEZEL ASSEMBLY AND LCD PANEL

(Please review the [Sony Electronics Service Information](#) website for any additional service information.)

☆ 2-580-640-01 SCREW, +BVTP2 4X16

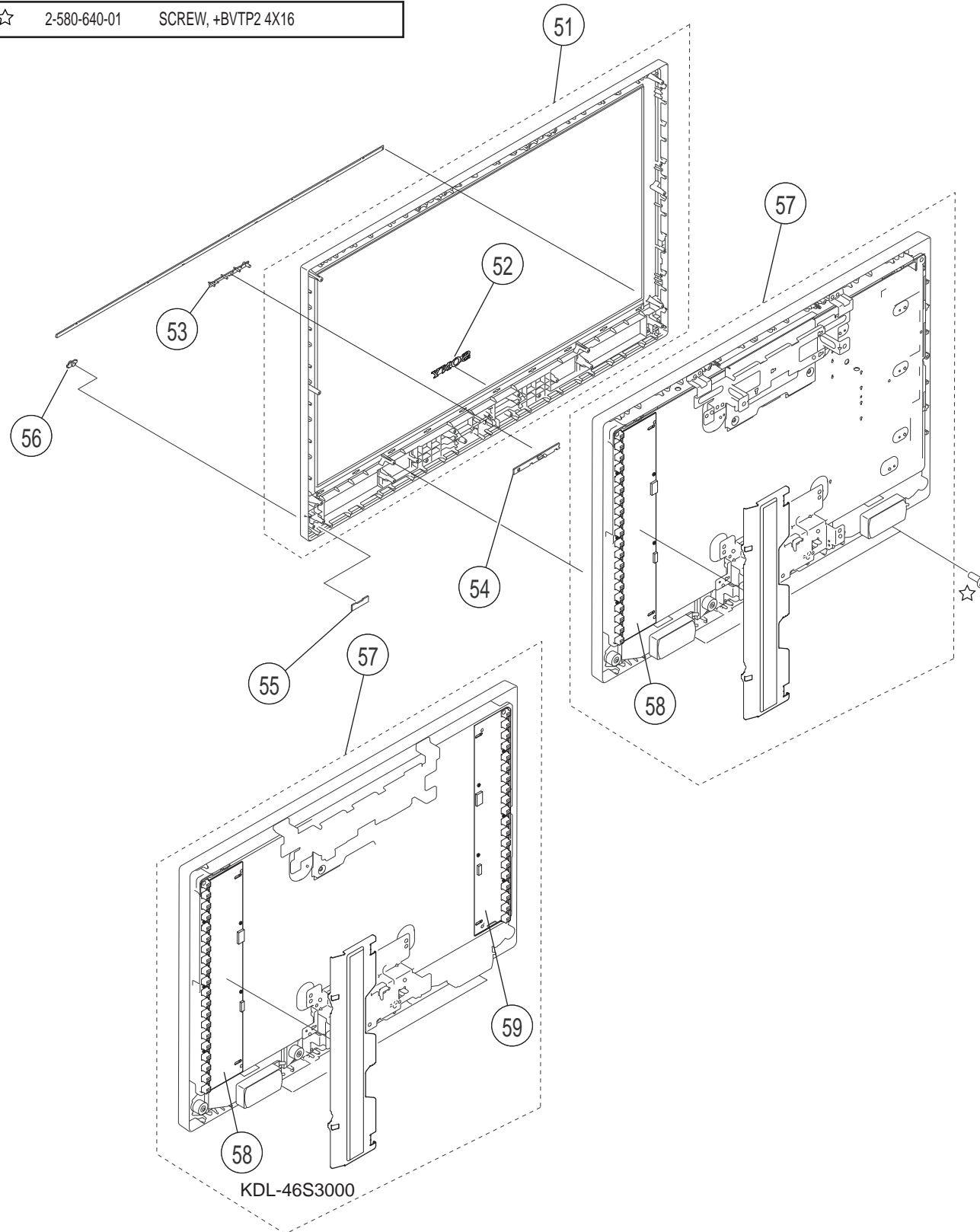

REF. NO.	PART NO.	DESCRIPTION	[ASSEMBLY INCLUDES]	REF. NO.	PART NO.	DESCRIPTION	[ASSEMBLY INCLUDES]
51	X-2178-399-1	BEZEL (26SU) ASSEMBLY (KDL-26S3000 ONLY)	[2]	57	1-802-368-12	LCD PANEL (26INCH WXGA TFT) (KDL-26S3000 ONLY)	[58]
51	X-2176-650-1	BEZEL (32SU) ASSEMBLY (KDL-32S3000 ONLY)	[2]	57	1-802-380-12	LCD PANEL (32INCH WXGA TFT) (KDL-32S3000 ONLY)	[58]
51	X-2176-651-1	BEZEL (40SU) ASSEMBLY (KDL-40S3000 ONLY)		57	1-802-410-11	LCD PANEL (40INCH WXGA TFT) (KDL-40S3000 ONLY)	[58]
51	X-2176-652-1	BEZEL (46SU) ASSEMBLY (KDL-46S3000 ONLY)		57	1-802-409-21	LCD PANEL (46INCH WXGA TFT) (KDL-46S3000 ONLY)	[58-59]
52	4-103-642-21	EMBLEM, SONY NO.8 (KDL-26S3000/32S3000 ONLY)		58	1-789-780-11	ETC-INVERTER MT BOARD (KDL-26S3000 ONLY)	
53	3-096-948-01	GUIDE , LED (S)		58	1-789-785-11	ETC-INVERTER MT BOARD (KDL-32S3000 ONLY)	
54	A-1220-319-A	H3 BOARD, MOUNTED		58	1-789-771-11	ETC-INVERTER MT BOARD (KDL-40S3000 ONLY)	
55	A-1220-320-A	H4 BOARD, MOUNTED				(When replacing the Inverter board for this model, refer to the instructions for "Replacing the Inverter Connector Assembly" in the Disassembly section of this manual.)	
56	3-094-434-11	GUIDE, LIGHT (S) S (KDL-26S3000 ONLY)		58	1-789-787-11	ETC-INVERTER MT BOARD (LEFT) (KDL-46S3000 ONLY)	
56	3-097-341-11	GUIDE, LIGHT (S) L (KDL-32S3000/40S3000/46S3000 ONLY)				(When replacing the Inverter board for this model, refer to the instructions for "Replacing the Inverter Connector Assembly" in the Disassembly section of this manual.)	
				59	1-789-788-11	ETC-INVERTER MT BOARD (RIGHT) (KDL-46S3000 ONLY)	
						(When replacing the Inverter board for this model, refer to the instructions for "Replacing the Inverter Connector Assembly" in the Disassembly section of this manual.)	

NOTE: The components identified by shading and  mark are critical for safety. Replace only with part number specified.

NOTE: Les composants identifiés par un trame et une marque  sont critiques pour la sécurité. Ne les remplacer que par une pièce portant le numéro spécifié.



NOTE: The components identified by a red outline and a  mark contain confidential information. Specific instructions must be adhered to whenever these components are repaired and/or replaced. See Appendix A: Encryption Key Components in the back of this manual.

4-3. CHASSIS (KDL-26S3000/32S3000 ONLY)

(Please review the [Sony Electronics Service Information](#) website for any additional service information.)

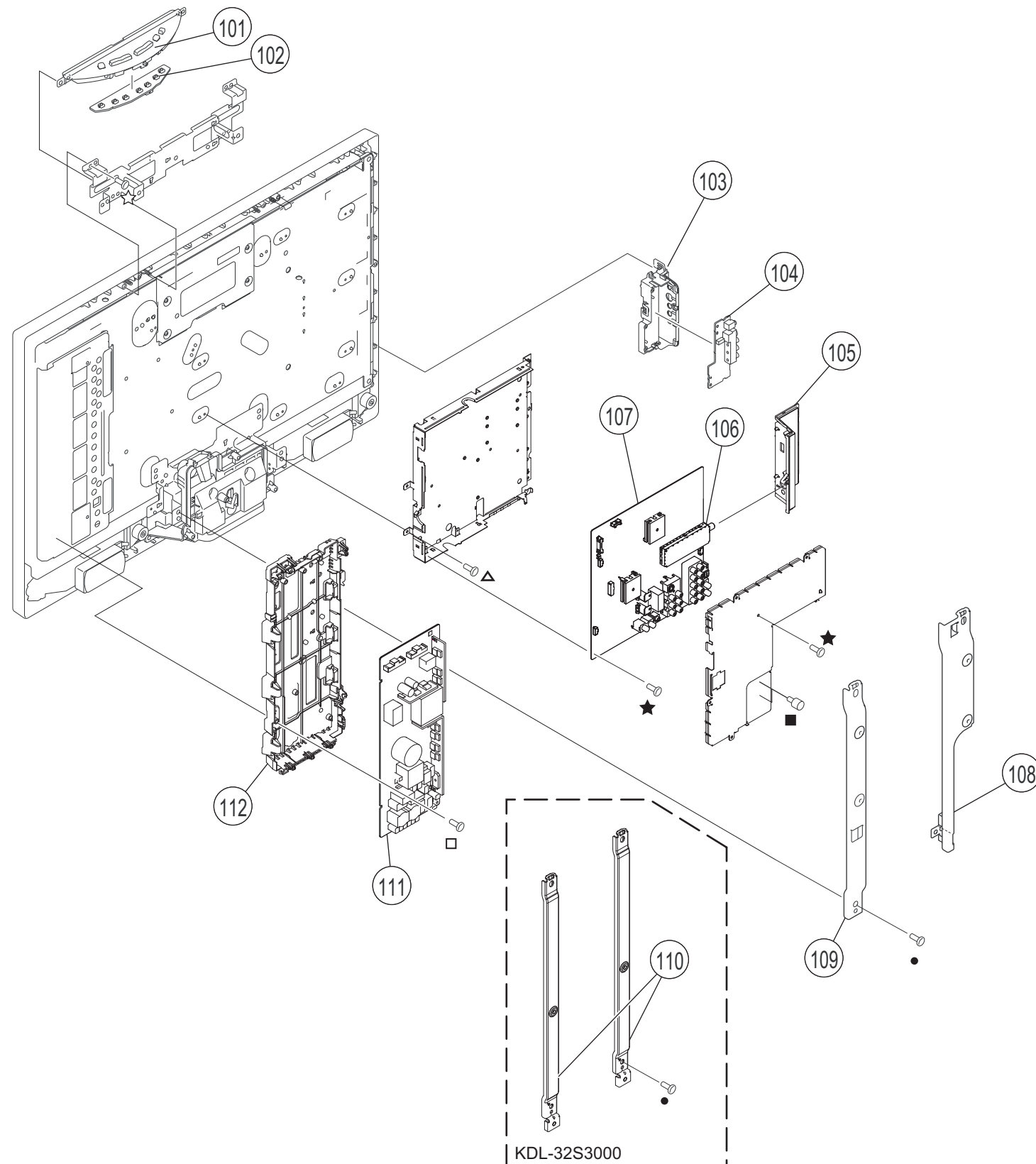
☆	2-580-640-01	SCREW, +BVTP2 4X16 (KDL-40S3000/46S3000 ONLY)
★	2-580-629-01	SCREW, +BVST 3X8
△	2-580-591-01	SCREW, +PSW M3X5
●	2-580-608-01	SCREW, +PSW M5X16
□	2-674-965-31	SCREW, +PSW 3SG (KDL-26S3000/32S3000 ONLY)
■	4-635-966-01	SCREW (HEX)



REF. NO.	PART NO.	DESCRIPTION	[ASSEMBLY INCLUDES]
101	X-2176-664-1	BUTTON, MULTI ASSEMBLY (KDL-26S3000/32S3000 ONLY)	
102	A-1220-318-A	H1 BOARD, MOUNTED (KDL-26S3000/32S3000 ONLY)	
103	3-098-453-02	SIDE, TERMINAL(AU) (KDL-26S3000/32S3000 ONLY)	
104	A-1220-504-C	U1 BOARD, MOUNTED (KDL-26S3000/32S3000 ONLY)	
105	3-094-417-02	HOLDER, SIDE JACK(S) (KDL-26S3000 ONLY)	
105	3-106-473-01	HOLDER, SIDE JACK(M) (KDL-32S3000 ONLY)	
106	8-597-611-00	TUNER, FSS BTF-CA411Z	
	A-1268-869-A	BU1 BOARD, MOUNTED (SVC) (KDL-26S3000 ONLY)	
	A-1257-244-A	BU1 BOARD, MOUNTED (SVC) (KDL-32S3000 ONLY)	
*	108	X-2177-262-1	VESA ARM (26) L ASSEMBLY (KDL-26S3000 ONLY)
*	109	X-2177-263-1	VESA ARM (26) R ASSEMBLY (KDL-26S3000 ONLY)
	110	X-2177-549-1	VESA ARM(32) ASSEMBLY (KDL-32S3000 ONLY)
	111	1-474-056-11	G1D BOARD, MOUNTED (POWER UNIT) (KDL-26S3000 ONLY) This board is manufactured by a 3rd party. Component level repair information is not available.
	111	1-474-052-11	G1H BOARD, MOUNTED (POWER UNIT) (KDL-32S3000 ONLY) This board is manufactured by a 3rd party. Component level repair information is not available.
*	112	3-106-471-01	BRACKET, G1 (KDL-26S3000/32S3000 ONLY)

NOTE: The components identified by shading and  mark are critical for safety. Replace only with part number specified.

NOTE: Les composants identifiés par un trame et  sont critiques pour la sécurité. Ne les remplacer que par une pièce portant le numéro spécifié.

NOTE: The components identified by a red outline and a  mark contain confidential information. Specific instructions must be adhered to whenever these components are repaired and/or replaced. See Appendix A: Encryption Key Components in the back of this manual.



4-4. CHASSIS (KDL-40S3000/46S3000 ONLY)

(Please review the [Sony Electronics Service Information](#) website for any additional service information.)

- ☆ 2-580-640-01 SCREW, +BVTP2 4X16 (KDL-40S3000/46S3000 ONLY)
- ★ 2-580-629-01 SCREW, +BVST 3X8 (KDL-40S3000/46S3000 ONLY)
- △ 2-580-591-01 SCREW, +PSW M3X5 (KDL-40S3000/46S3000 ONLY)
- ▲ 2-580-606-01 SCREW, +PSW M5X8 (KDL-40S3000/46S3000 ONLY)

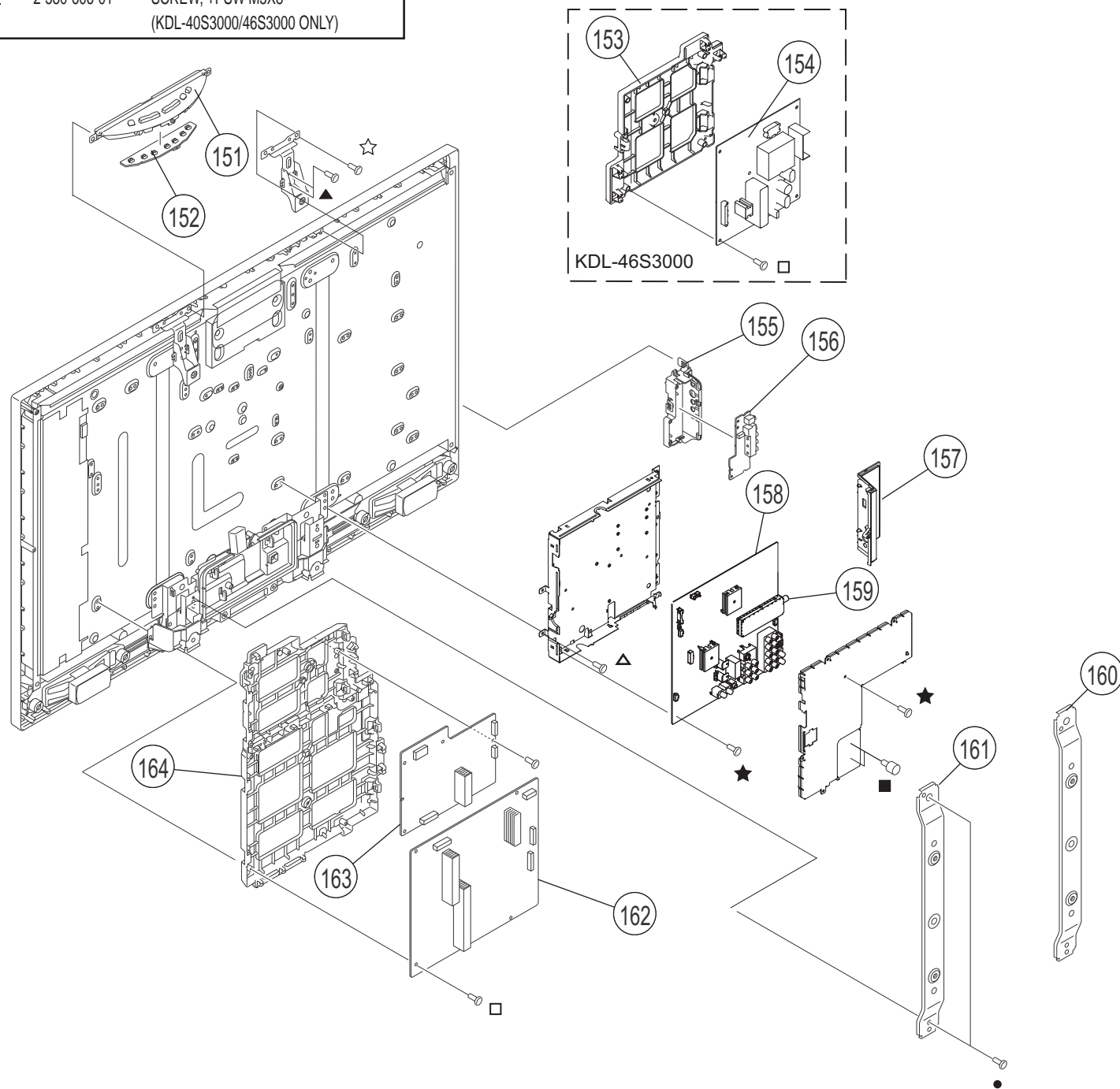
- 2-674-965-41 SCREW, +PSW 3SG (KDL-40S3000/46S3000 ONLY)
- 2-580-608-01 SCREW, +PSW M5X16 (KDL-40S3000/46S3000 ONLY)
- ▽ 4-635-966-01 SCREW (HEX) (KDL-40S3000/46S3000 ONLY)



REF. NO.	PART NO.	DESCRIPTION	[ASSEMBLY INCLUDES]	REF. NO.	PART NO.	DESCRIPTION	[ASSEMBLY INCLUDES]
151	X-2176-664-1	BUTTON, MULTI ASSEMBLY (KDL-40S3000/46S3000 ONLY)		* 161	X-2177-260-1	VESA ARM(40)R ASSEMBLY (KDL-40S3000 ONLY)	
152	A-1220-318-A	H1 BOARD, MOUNTED (KDL-40S3000/46S3000 ONLY)		* 161	X-2177-276-1	VESA ARM(46)R ASSEMBLY (KDL-46S3000 ONLY)	
153	3-094-416-01	BRACKET, D2 (KDL-46S3000 ONLY)		162	A-1308-804-A	G3 BOARD, COMPLETE (KDL-40S3000/46S3000 ONLY)	
154	A-1247-497-A	D2 BOARD, COMPLETE (KDL-46S3000 ONLY)		163	A-1236-528-A	D1 BOARD, COMPLETE (KDL-40S3000 ONLY)	
(When replacing the D2 Board for this model, refer to the instructions for "Replacing the Inverter Connector Assembly" in the Disassembly section of this manual.)				(When replacing the D1 Board for this model, refer to the instructions for "Replacing the Inverter Connector Assembly" in the Disassembly section of this manual.)			
155	3-098-453-02	SIDE, TERMINAL(AU) (KDL-40S3000/46S3000 ONLY)		163	A-1236-531-A	D1 BOARD, COMPLETE (KDL-46S3000 ONLY)	
156	A-1220-504-C	U1 BOARD, MOUNTED (KDL-40S3000/46S3000 ONLY)		(When replacing the D1 Board for this model, refer to the instructions for "Replacing the Inverter Connector Assembly" in the Disassembly section of this manual.)			
157	3-106-473-01	HOLDER, SIDE JACK(M) (KDL-40S3000 ONLY)		164	X-2178-425-1	BRACKET ASSEMBLY, G3 (KDL-40S3000/46S3000 ONLY)	
157	3-106-474-01	HOLDER, SIDE JACK(L) (KDL-46S3000 ONLY)					
	A-1257-243-A	BU1 BOARD, MOUNTED (SVC) (KDL-40S3000 ONLY)					
	A-1257-242-A	BU1 BOARD, MOUNTED (SVC) (KDL-46S3000 ONLY)					
159	8-597-611-00	TUNER, FSS BTF-CA411Z (KDL-40S3000/46S3000 ONLY)					
* 160	X-2177-259-1	VESA ARM(40)L ASSEMBLY (KDL-40S3000 ONLY)					
* 160	X-2177-275-1	VESA ARM(46)L ASSEMBLY (KDL-46S3000 ONLY)					

NOTE: The components identified by shading and  mark are critical for safety. Replace only with part number specified.

NOTE: Les composants identifiés par un trame et une marque  sont critiques pour la sécurité. Ne les remplacer que par une pièce portant le numéro spécifié.

NOTE: The components identified by a red outline and a  mark contain confidential information. Specific instructions must be adhered to whenever these components are repaired and/or replaced. See Appendix A: Encryption Key Components in the back of this manual.

4-5. CONNECTORS (KDL-26S3000/32S3000 ONLY)

(Please review the [Sony Electronics Service Information](#) website for any additional service information.)

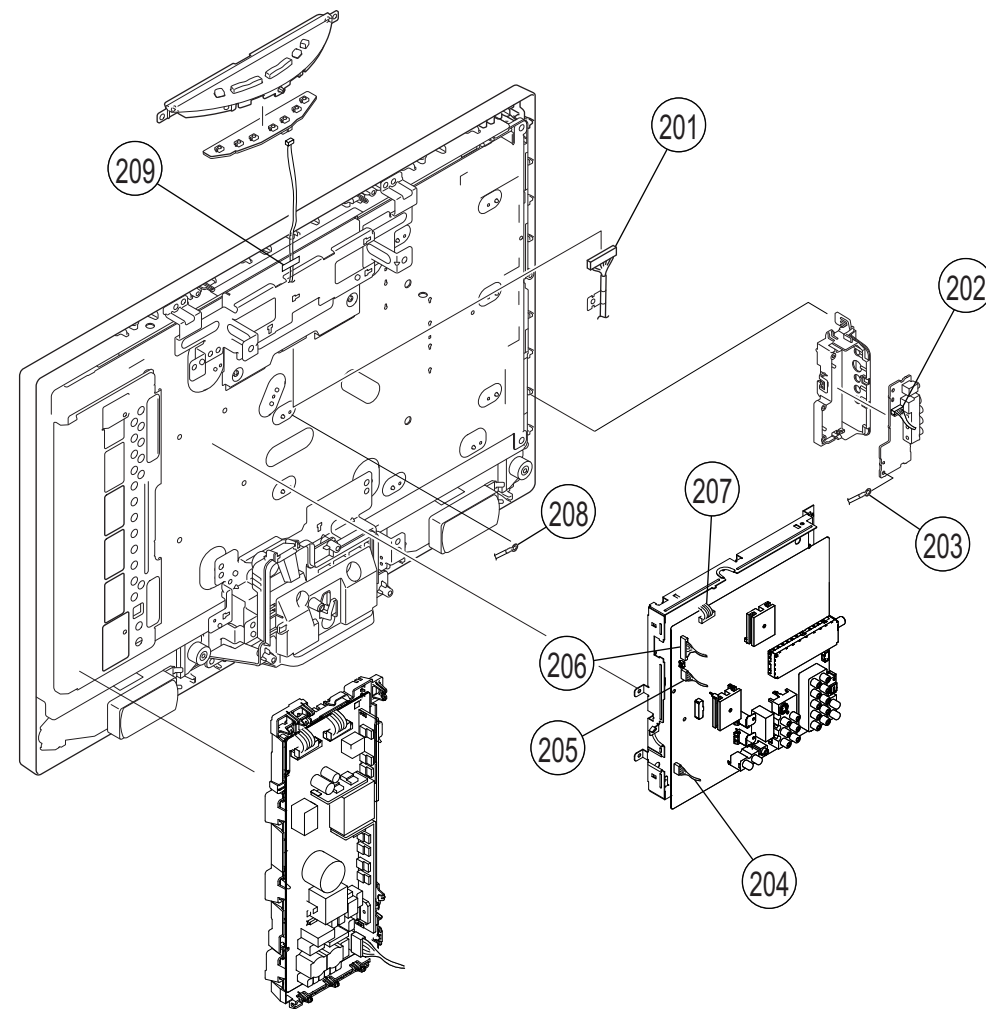

REF. NO.	PART NO.	DESCRIPTION	[ASSEMBLY INCLUDES]	REF. NO.	PART NO.	DESCRIPTION	[ASSEMBLY INCLUDES]
201	1-834-155-11	HARNESS WITH CONNECTOR (LVDS) (KDL-26S3000 ONLY)		206	1-910-037-11	CONNECTOR ASSEMBLY, 13P (KDL-26S3000 ONLY)	
201	1-834-157-11	HARNESS WITH CONNECTOR (LVDS) (KDL-32S3000 ONLY)		206	1-910-035-50	CONNECTOR ASSEMBLY, 13P (KDL-32S3000 ONLY)	
202	1-910-037-09	CONN ASSEMBLY, 20P (KDL-26S3000 ONLY)		207	1-910-037-10	CONNECTOR ASSEMBLY, 14P (KDL-26S3000 ONLY)	
202	1-910-035-48	CONN ASSEMBLY, 20P (KDL-32S3000 ONLY)		207	1-910-035-49	CONNECTOR ASSEMBLY, 14P (KDL-32S3000 ONLY)	
203	1-910-035-53	WIRE ASSEMBLY, FASTON TERMINAL (KDL-26S3000/32S3000 ONLY)		208	1-910-035-47	WIRE ASSEMBLY, FASTON TERMINAL (KDL-32S3000 ONLY)	
204	1-910-037-12	CONNECTOR ASSEMBLY, 4P SPEAKER (KDL-26S3000 ONLY)		209	2-893-754-01	TAPE (LCD) (KDL-26S3000 ONLY)	
204	1-910-035-51	CONNECTOR ASSEMBLY, 4P SP (KDL-32S3000 ONLY)		209	2-688-062-01	TAPE (LCD) (KDL-32S3000 ONLY)	
205	1-910-037-13	CONNECTOR ASSEMBLY, 20P (KDL-26S3000 ONLY)					
205	1-910-035-52	CONNECTOR ASSEMBLY, 20P (KDL-32S3000 ONLY)					

NOTE: The components identified by shading and  mark are critical for safety. Replace only with part number specified.

NOTE: Les composants identifiés par un trame et une marque  sont critiques pour la sécurité. Ne les remplacer que par une pièce portant le numéro spécifié.

NOTE: The components identified by a red outline and a  mark contain confidential information. Specific instructions must be adhered to whenever these components are repaired and/or replaced. See Appendix A: Encryption Key Components in the back of this manual.

4-6. CONNECTORS (KDL-40S3000/46S3000 ONLY)

(Please review the [Sony Electronics Service Information](#) website for any additional service information.)

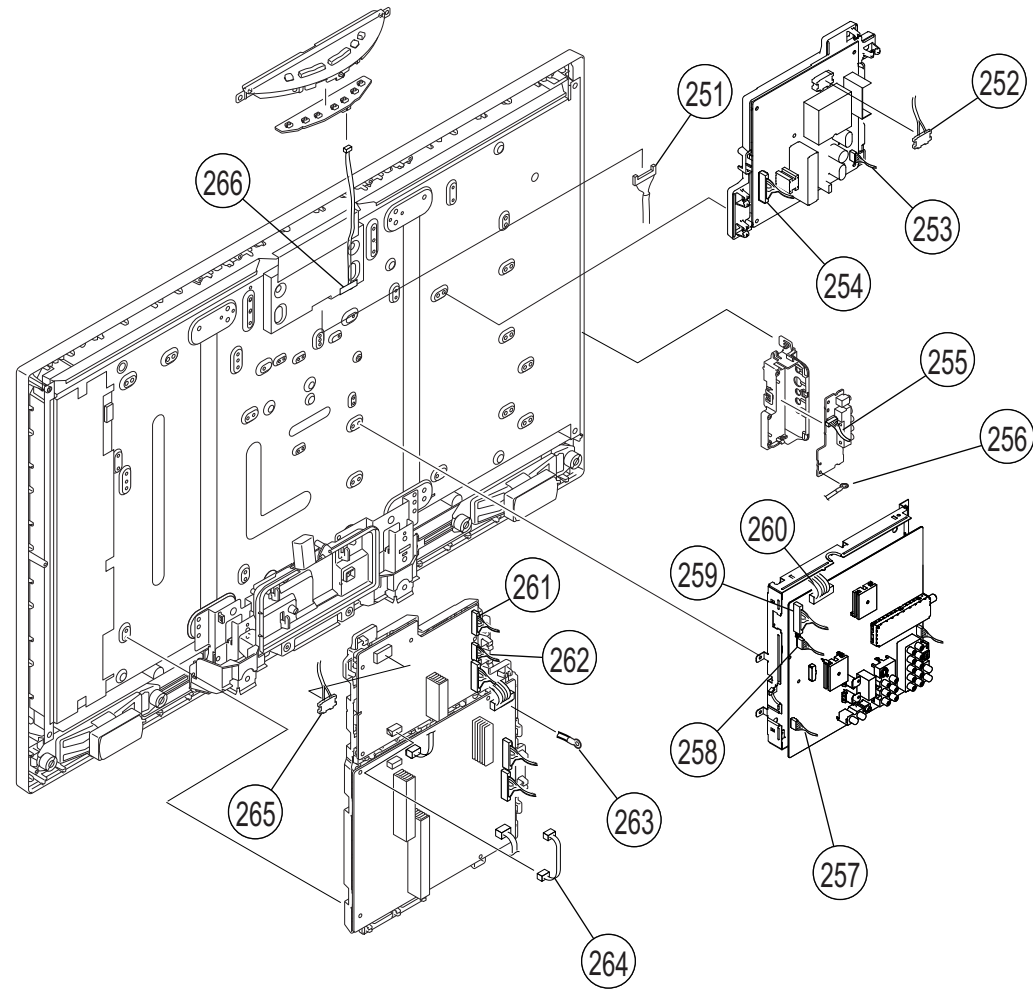

REF. NO.	PART NO.	DESCRIPTION	[ASSEMBLY INCLUDES]	REF. NO.	PART NO.	DESCRIPTION	[ASSEMBLY INCLUDES]
251	1-834-158-11	HARNESS WITH CONNECTOR (LVDS) (KDL-40S3000 ONLY)		259	1-910-035-56	CONNECTOR ASSEMBLY, 12P (KDL-40S3000 ONLY)	
251	1-834-159-11	HARNESS WITH CONNECTOR (LVDS) (KDL-46S3000 ONLY)		259	1-910-035-34	CONNECTOR ASSEMBLY, 12P (KDL-46S3000 ONLY)	
* 252	1-833-929-12	CONNECTOR ASSEMBLY (KDL-46S3000 ONLY)		260	1-910-035-57	CONNECTOR ASSEMBLY, 11P (KDL-40S3000 ONLY)	
(When replacing the Connector Assembly for this model, refer to the instructions for "Replacing the Inverter Connector Assembly" in the Disassembly section of this manual.)				260	1-910-035-35	CONNECTOR ASSEMBLY, 11P (KDL-46S3000 ONLY)	
253	1-833-958-11	CONNECTOR ASSEMBLY (KDL-46S3000 ONLY)		261	1-910-035-58	CONNECTOR ASSEMBLY, 8P XA (KDL-40S3000/46S3000 ONLY)	
254	1-910-035-38	CONNECTOR ASSEMBLY, 13P XA (KDL-46S3000 ONLY)		262	1-910-035-59	CONNECTOR ASSEMBLY, 7P XA (KDL-40S3000 ONLY)	
255	1-910-035-54	CONNECTOR ASSEMBLY, 20P (KDL-40S3000 ONLY)		262	1-910-035-40	CONNECTOR ASSEMBLY, 7P XA (KDL-46S3000 ONLY)	
255	1-910-035-32	CONNECTOR ASSEMBLY, 20P (KDL-46S3000 ONLY)		263	1-910-035-46	WIRE ASSEMBLY, FASTON TERMINAL (KDL-46S3000 ONLY)	
256	1-910-036-31	WIRE ASSEMBLY, FASTON TERMINAL (KDL-40S3000 ONLY)		264	1-833-957-11	CONNECTOR ASSEMBLY (KDL-40S3000/46S3000 ONLY)	
256	1-910-036-30	WIRE ASSEMBLY, FASTON TERMINAL (KDL-46S3000 ONLY)		265	1-833-927-12	CONNECTOR ASSEMBLY (KDL-40S3000 ONLY)	
257	1-910-035-55	CONNECTOR ASSEMBLY, 4P SP (KDL-40S3000 ONLY)		(When replacing the Connector Assembly for this model, refer to the instructions for "Replacing the Inverter Connector Assembly" in the Disassembly section of this manual.)			
257	1-910-035-33	CONNECTOR ASSEMBLY, 4P SP (KDL-46S3000 ONLY)		265	1-833-928-12	CONNECTOR ASSEMBLY (KDL-46S3000 ONLY)	
258	1-910-035-62	CONNECTOR ASSEMBLY, 20P (KDL-40S3000 ONLY)		(When replacing the Connector Assembly for this model, refer to the instructions for "Replacing the Inverter Connector Assembly" in the Disassembly section of this manual.)			
258	1-910-035-44	CONNECTOR ASSEMBLY, 20P (KDL-46S3000 ONLY)		266	2-893-754-01	TAPE (LCD) (KDL-40S3000/46S3000 ONLY)	

NOTE: The components identified by shading and  mark are critical for safety. Replace only with part number specified.

NOTE: Les composants identifiés par un trame et une marque  sont critiques pour la sécurité. Ne les remplacer que par une pièce portant le numéro spécifié.



NOTE: The components identified by a red outline and a  mark contain confidential information. Specific instructions must be adhered to whenever these components are repaired and/or replaced. See Appendix A: Encryption Key Components in the back of this manual.

4-7. SPEAKERS

(Please review the [Sony Electronics Service Information](#) website for any additional service information.)

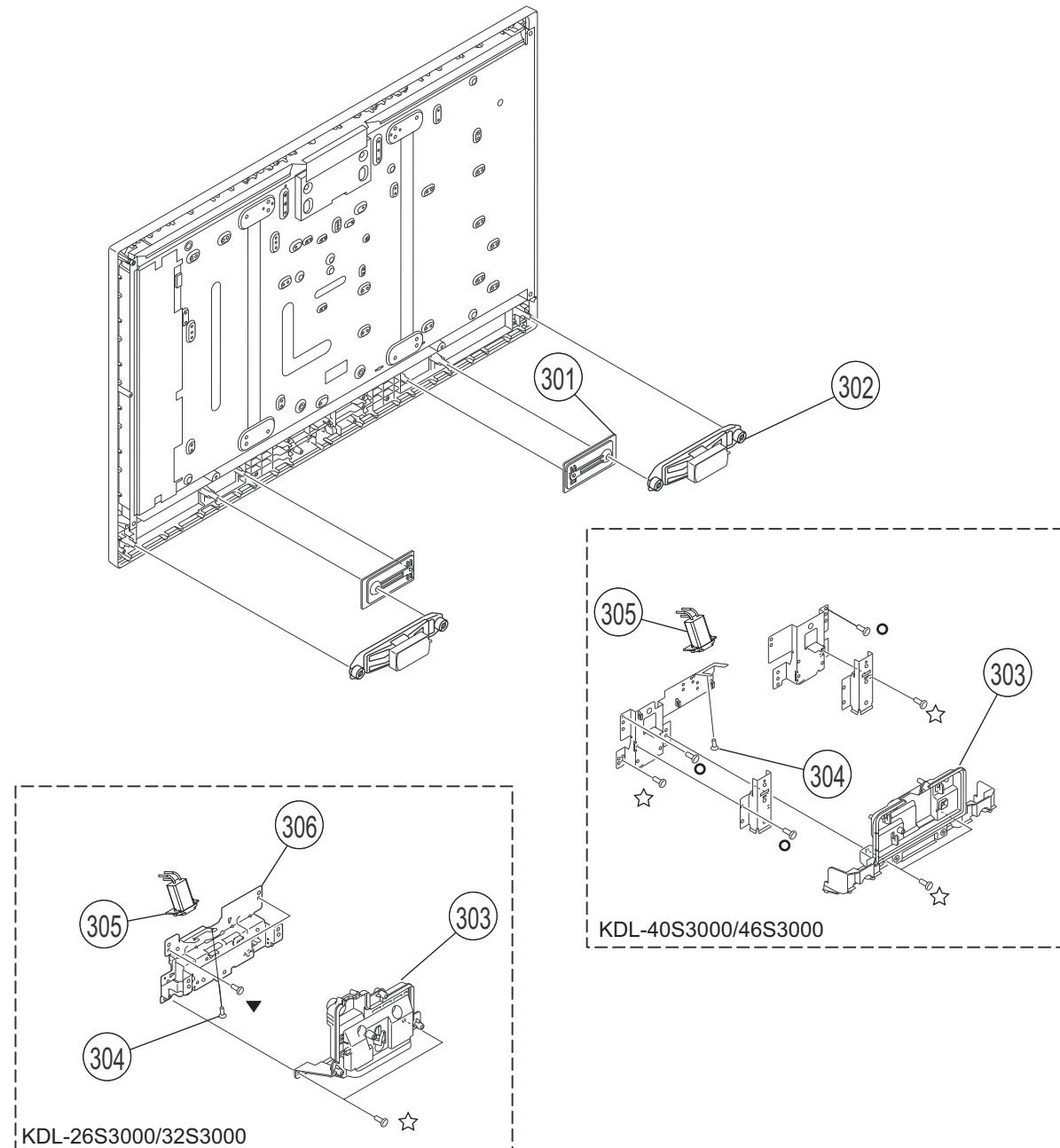
- ☆ 2-580-640-01 SCREW, +BVTP2 4X16
- ▼ 2-580-600-01 SCREW, +PSW M4X8
- 2-580-607-01 SCREW, +PSW M5X12
(KDL-40S3000/46S3000 ONLY)



REF. NO.	PART NO.	DESCRIPTION	[ASSEMBLY INCLUDES]	REF. NO.	PART NO.	DESCRIPTION	[ASSEMBLY INCLUDES]
301	X-2176-950-1	BAFFLE (40J) ASSEMBLY (KDL-40S3000 ONLY)		303	3-100-284-01	COVER, UNDER (M) (KDL-26S3000/32S3000 ONLY)	
301	X-2176-951-1	BAFFLE (46J) ASSEMBLY (KDL-46S3000 ONLY)		303	X-2179-456-1	COVER ASSEMBLY, UNDER (L) (KDL-40S3000/46S3000 ONLY)	
302	1-826-649-11	LOUD SPEAKER (4.2X15CM) (KDL-26S3000 ONLY)		304	2-596-649-01	+KTT 3X10 (S TYPE) (KDL-32S3000/40S3000/46S3000 ONLY)	
302	1-826-648-11	LOUD SPEAKER (4.2X15CM) (KDL-32S3000 ONLY)		 305	1-821-380-11	INLET, AC (WITH NOISE FILTER) (KDL-26S3000 ONLY)	
302	1-826-647-11	LOUD SPEAKER (5.5X15.5CM) (KDL-40S3000 ONLY)		 305	1-819-729-14	INLET, AC (WITH NOISE FILTER) (KDL-32S3000/40S3000/46S3000 ONLY)	
302	1-826-646-11	LOUD SPEAKER (13X7CM) (KDL-46S3000 ONLY)		* 306	X-2177-438-2	LCD BRACKET BOTTOM ASSEMBLY (26/32) (KDL-26S3000/32S3000 ONLY)	

SECTION 5: ELECTRICAL PARTS LIST

NOTE: The components identified by shading and \triangle mark are critical for safety. Replace only with part number specified.

NOTE: Les composants identifiés par un trame et une marque \triangle sont critiques pour la sécurité. Ne les remplacer que par une pièce portant le numéro spécifié.

* Items marked with an asterisk are not stocked since they are seldom required for routine service. Expect some delay when ordering these components.

NOTE: The components identified by a red outline and a \triangle mark contain confidential information. Specific instructions must be adhered to whenever these components are repaired and/or replaced.
See Appendix A: Encryption Key Components in the back of this manual.

RESISTORS

- All resistors are in ohms
- F : nonflammable
- All variable and adjustable resistors have characteristic curve B, unless otherwise noted.

BU1

When ordering parts by reference number, please include the board name.

BU1

\triangle	A-1268-869-A	BU1 BOARD, MOUNTED (SVC) (KDL-26S3000 ONLY)
\triangle	A-1257-244-A	BU1 BOARD, MOUNTED (SVC) (KDL-32S3000 ONLY)
\triangle	A-1257-243-A	BU1 BOARD, MOUNTED (SVC) (KDL-40S3000 ONLY)
\triangle	A-1257-242-A	BU1 BOARD, MOUNTED (SVC) (KDL-46S3000 ONLY)

CONTACT TERMINAL

A4500	4-098-157-01	HEAT SINK (DTT)
A4501	1-694-974-21	CONTACT TERMINAL
A4502	1-694-974-21	CONTACT TERMINAL
A7300	4-098-157-01	HEAT SINK (DTT)
A7301	1-694-974-21	CONTACT TERMINAL
A7302	1-694-974-21	CONTACT TERMINAL

CAPACITOR

C1000	1-162-970-11	CERAMIC CHIP	0.01 μ F	10%	25V
C1001	1-162-970-11	CERAMIC CHIP	0.01 μ F	10%	25V
C1002	1-112-781-11	CERAMIC CHIP	1 μ F	10%	10V
C1003	1-162-970-11	CERAMIC CHIP	0.01 μ F	10%	25V
C1005	1-100-912-11	CERAMIC CHIP	1 μ F	10%	25V
C1007	1-100-912-11	CERAMIC CHIP	1 μ F	10%	25V
C1008	1-162-970-11	CERAMIC CHIP	0.01 μ F	10%	25V
C1010	1-100-912-11	CERAMIC CHIP	1 μ F	10%	25V
C1012	1-100-912-11	CERAMIC CHIP	1 μ F	10%	25V
C1100	1-100-912-11	CERAMIC CHIP	1 μ F	10%	25V
C1102	1-100-912-11	CERAMIC CHIP	1 μ F	10%	25V
C1130	1-100-912-11	CERAMIC CHIP	1 μ F	10%	25V
C1132	1-100-912-11	CERAMIC CHIP	1 μ F	10%	25V
C1403	1-100-905-11	CERAMIC CHIP	0.001 μ F	10%	50V
C1405	1-100-905-11	CERAMIC CHIP	0.001 μ F	10%	50V

REF. NO.	PART NO.	DESCRIPTION	VALUES
C1714	1-100-912-11	CERAMIC CHIP	1 μ F 10% 25V
C1715	1-100-912-11	CERAMIC CHIP	1 μ F 10% 25V
C1722	1-100-905-11	CERAMIC CHIP	0.001 μ F 10% 50V
C1723	1-100-905-11	CERAMIC CHIP	0.001 μ F 10% 50V
C1724	1-100-912-11	CERAMIC CHIP	1 μ F 10% 25V
C1725	1-100-912-11	CERAMIC CHIP	1 μ F 10% 25V
C2013	1-126-392-11	ELECT CHIP	100 μ F 20% 6.3V
C2014	1-100-905-11	CERAMIC CHIP	0.001 μ F 10% 50V
C2016	1-112-046-11	CERAMIC CHIP	4.7 μ F 10% 6.3V
C2017	1-100-905-11	CERAMIC CHIP	0.001 μ F 10% 50V
C2019	1-100-911-11	CERAMIC CHIP	4.7 μ F 10% 25V
C2022	1-100-905-11	CERAMIC CHIP	0.001 μ F 10% 50V
C2025	1-112-046-11	CERAMIC CHIP	4.7 μ F 10% 6.3V
C2027	1-100-905-11	CERAMIC CHIP	0.001 μ F 10% 50V
C2029	1-164-849-11	CERAMIC CHIP	9pF 0.50pF 50V
C2030	1-164-849-11	CERAMIC CHIP	9pF 0.50pF 50V
C2033	1-114-325-11	CERAMIC CHIP	0.1 μ F 10% 25V
C2039	1-100-905-11	CERAMIC CHIP	0.001 μ F 10% 50V
C2041	1-100-911-11	CERAMIC CHIP	4.7 μ F 10% 25V
C2042	1-100-905-11	CERAMIC CHIP	0.001 μ F 10% 50V
C2045	1-100-905-11	CERAMIC CHIP	0.001 μ F 10% 50V
C2051	1-112-046-11	CERAMIC CHIP	4.7 μ F 10% 6.3V
C2052	1-162-959-11	CERAMIC CHIP	330pF 5% 50V
C2053	1-162-959-11	CERAMIC CHIP	330pF 5% 50V
C2054	1-100-911-11	CERAMIC CHIP	4.7 μ F 10% 25V
C2055	1-100-905-11	CERAMIC CHIP	0.001 μ F 10% 50V
C2058	1-100-905-11	CERAMIC CHIP	0.001 μ F 10% 50V
C2059	1-100-911-11	CERAMIC CHIP	4.7 μ F 10% 25V
C2060	1-126-392-11	ELECT CHIP	100 μ F 20% 6.3V
C2061	1-114-325-11	CERAMIC CHIP	0.1 μ F 10% 25V
C2062	1-114-325-11	CERAMIC CHIP	0.1 μ F 10% 25V
C2063	1-114-325-11	CERAMIC CHIP	0.1 μ F 10% 25V
C2064	1-112-781-11	CERAMIC CHIP	1 μ F 10% 10V
C2065	1-112-781-11	CERAMIC CHIP	1 μ F 10% 10V
C2067	1-100-911-11	CERAMIC CHIP	4.7 μ F 10% 25V

BU1

REF. NO.	PART NO.	DESCRIPTION	VALUES			REF. NO.	PART NO.	DESCRIPTION	VALUES		
C2068	1-100-905-11	CERAMIC CHIP	0.001 μ F	10%	50V	C2132	1-115-340-11	CERAMIC CHIP	0.22 μ F	10%	25V
C2069	1-112-064-11	CERAMIC CHIP	2.2 μ F	10%	10V	C2133	1-115-340-11	CERAMIC CHIP	0.22 μ F	10%	25V
C2070	1-112-064-11	CERAMIC CHIP	2.2 μ F	10%	10V	C2134	1-112-064-11	CERAMIC CHIP	2.2 μ F	10%	10V
C2073	1-114-330-11	CERAMIC CHIP	2.2 μ F	10%	16V	C2135	1-112-064-11	CERAMIC CHIP	2.2 μ F	10%	10V
C2074	1-100-764-21	ELECT CHIP	4.7 μ F	20%	25V	C2136	1-115-340-11	CERAMIC CHIP	0.22 μ F	10%	25V
C2075	1-100-764-21	ELECT CHIP	4.7 μ F	20%	25V	C2137	1-115-340-11	CERAMIC CHIP	0.22 μ F	10%	25V
C2077	1-126-396-11	ELECT CHIP	47 μ F	20%	16V	C2138	1-115-340-11	CERAMIC CHIP	0.22 μ F	10%	25V
C2078	1-114-330-11	CERAMIC CHIP	2.2 μ F	10%	16V	C2139	1-115-340-11	CERAMIC CHIP	0.22 μ F	10%	25V
C2081	1-162-959-11	CERAMIC CHIP	330pF	5%	50V	C2140	1-112-064-11	CERAMIC CHIP	2.2 μ F	10%	10V
C2084	1-162-959-11	CERAMIC CHIP	330pF	5%	50V	C2141	1-114-330-11	CERAMIC CHIP	2.2 μ F	10%	16V
C2085	1-126-396-11	ELECT CHIP	47 μ F	20%	16V	C2142	1-164-874-11	CERAMIC CHIP	100pF	5%	50V
C2086	1-100-905-11	CERAMIC CHIP	0.001 μ F	10%	50V	C2143	1-112-064-11	CERAMIC CHIP	2.2 μ F	10%	10V
C2090	1-114-325-11	CERAMIC CHIP	0.1 μ F	10%	25V	C2144	1-164-874-11	CERAMIC CHIP	100pF	5%	50V
C2091	1-112-064-11	CERAMIC CHIP	2.2 μ F	10%	10V	C2145	1-100-912-11	CERAMIC CHIP	1 μ F	10%	25V
C2092	1-112-064-11	CERAMIC CHIP	2.2 μ F	10%	10V	C2146	1-100-912-11	CERAMIC CHIP	1 μ F	10%	25V
C2094	1-162-927-11	CERAMIC CHIP	100pF	5%	50V	C2149	1-126-396-11	ELECT CHIP	47 μ F	20%	16V
C2095	1-100-912-11	CERAMIC CHIP	1 μ F	10%	25V	C2150	1-126-396-11	ELECT CHIP	47 μ F	20%	16V
C2096	1-162-927-11	CERAMIC CHIP	100pF	5%	50V	C2156	1-114-325-11	CERAMIC CHIP	0.1 μ F	10%	25V
C2097	1-114-325-11	CERAMIC CHIP	0.1 μ F	10%	25V	C2157	1-114-325-11	CERAMIC CHIP	0.1 μ F	10%	25V
C2101	1-100-905-11	CERAMIC CHIP	0.001 μ F	10%	50V	C2158	1-114-325-11	CERAMIC CHIP	0.1 μ F	10%	25V
C2102	1-100-905-11	CERAMIC CHIP	0.001 μ F	10%	50V	C2159	1-100-905-11	CERAMIC CHIP	0.001 μ F	10%	50V
C2103	1-100-764-21	ELECT CHIP	4.7 μ F	20%	25V	C2160	1-100-905-11	CERAMIC CHIP	0.001 μ F	10%	50V
C2104	1-100-764-21	ELECT CHIP	4.7 μ F	20%	25V	C2161	1-100-905-11	CERAMIC CHIP	0.001 μ F	10%	50V
C2105	1-100-764-21	ELECT CHIP	4.7 μ F	20%	25V	C2162	1-112-064-11	CERAMIC CHIP	2.2 μ F	10%	10V
C2106	1-100-764-21	ELECT CHIP	4.7 μ F	20%	25V	C2163	1-112-064-11	CERAMIC CHIP	2.2 μ F	10%	10V
C2111	1-114-325-11	CERAMIC CHIP	0.1 μ F	10%	25V	C2164	1-112-064-11	CERAMIC CHIP	2.2 μ F	10%	10V
C2112	1-100-764-21	ELECT CHIP	4.7 μ F	20%	25V	C2165	1-112-064-11	CERAMIC CHIP	2.2 μ F	10%	10V
C2113	1-112-777-11	CERAMIC CHIP	0.01 μ F	10%	25V	C2168	1-162-964-11	CERAMIC CHIP	0.001 μ F	10%	50V
C2114	1-100-764-21	ELECT CHIP	4.7 μ F	20%	25V	C2169	1-162-964-11	CERAMIC CHIP	0.001 μ F	10%	50V
C2115	1-115-340-11	CERAMIC CHIP	0.22 μ F	10%	25V	C2170	1-162-979-11	CERAMIC CHIP	0.0027 μ F	10%	50V
C2116	1-115-340-11	CERAMIC CHIP	0.22 μ F	10%	25V	C2171	1-162-979-11	CERAMIC CHIP	0.0027 μ F	10%	50V
C2117	1-100-905-11	CERAMIC CHIP	0.001 μ F	10%	50V	C2177	1-100-912-11	CERAMIC CHIP	1 μ F	10%	25V
C2118	1-100-905-11	CERAMIC CHIP	0.001 μ F	10%	50V	C2178	1-100-764-21	ELECT CHIP	4.7 μ F	20%	25V
C2119	1-115-340-11	CERAMIC CHIP	0.22 μ F	10%	25V	C2179	1-100-764-21	ELECT CHIP	4.7 μ F	20%	25V
C2120	1-115-340-11	CERAMIC CHIP	0.22 μ F	10%	25V	C2180	1-100-907-11	CERAMIC CHIP	0.1 μ F	10%	10V
C2121	1-100-905-11	CERAMIC CHIP	0.001 μ F	10%	50V	C2187	1-112-064-11	CERAMIC CHIP	2.2 μ F	10%	10V
C2123	1-112-797-11	ELECT CHIP	470 μ F	20%	25V	C2188	1-112-064-11	CERAMIC CHIP	2.2 μ F	10%	10V
C2124	1-112-800-11	ELECT CHIP	100 μ F	20%	35V	C2190	1-100-911-11	CERAMIC CHIP	4.7 μ F	10%	25V
C2125	1-114-325-11	CERAMIC CHIP	0.1 μ F	10%	25V	C2191	1-100-911-11	CERAMIC CHIP	4.7 μ F	10%	25V
C2126	1-100-912-11	CERAMIC CHIP	1 μ F	10%	25V	C2192	1-114-325-11	CERAMIC CHIP	0.1 μ F	10%	25V
C2127	1-100-912-11	CERAMIC CHIP	1 μ F	10%	25V	C3005	1-100-906-11	CERAMIC CHIP	0.01 μ F	10%	16V
C2128	1-112-800-11	ELECT CHIP	100 μ F	20%	35V	C3006	1-100-906-11	CERAMIC CHIP	0.01 μ F	10%	16V
C2129	1-114-325-11	CERAMIC CHIP	0.1 μ F	10%	25V	C3007	1-100-906-11	CERAMIC CHIP	0.01 μ F	10%	16V
C2130	1-114-325-11	CERAMIC CHIP	0.1 μ F	10%	25V	C3010	1-100-916-11	CERAMIC CHIP	0.1 μ F	10%	16V
C2131	1-126-396-11	ELECT CHIP	47 μ F	20%	16V	C3011	1-117-681-11	ELECT CHIP	100 μ F	20%	16V

BU1

REF. NO.	PART NO.	DESCRIPTION	VALUES			REF. NO.	PART NO.	DESCRIPTION	VALUES		
C3012	1-100-905-11	CERAMIC CHIP	0.001μF	10%	50V	C4041	1-112-774-11	CERAMIC CHIP	470pF	10%	50V
C3014	1-100-906-11	CERAMIC CHIP	0.01μF	10%	16V	C4042	1-112-774-11	CERAMIC CHIP	470pF	10%	50V
C3015	1-100-905-11	CERAMIC CHIP	0.001μF	10%	50V	C4043	1-112-774-11	CERAMIC CHIP	470pF	10%	50V
C3016	1-100-906-11	CERAMIC CHIP	0.01μF	10%	16V	C4044	1-112-774-11	CERAMIC CHIP	470pF	10%	50V
C3017	1-100-905-11	CERAMIC CHIP	0.001μF	10%	50V	C4045	1-112-774-11	CERAMIC CHIP	470pF	10%	50V
C3019	1-162-912-11	CERAMIC CHIP	7pF	0.50pF	50V	C4046	1-164-874-11	CERAMIC CHIP	100pF	5%	50V
C3022	1-112-066-11	CERAMIC CHIP	10μF	10%	10V	C4053	1-162-970-11	CERAMIC CHIP	0.01μF	10%	25V
C3024	1-112-066-11	CERAMIC CHIP	10μF	10%	10V	C4059	1-100-905-11	CERAMIC CHIP	0.001μF	10%	50V
C3029	1-100-905-11	CERAMIC CHIP	0.001μF	10%	50V	C4500	1-100-916-11	CERAMIC CHIP	0.1μF	10%	16V
C3033	1-100-905-11	CERAMIC CHIP	0.001μF	10%	50V	C4502	1-100-916-11	CERAMIC CHIP	0.1μF	10%	16V
C3036	1-112-781-11	CERAMIC CHIP	1μF	10%	10V	C4503	1-100-916-11	CERAMIC CHIP	0.1μF	10%	16V
C3044	1-112-781-11	CERAMIC CHIP	1μF	10%	10V	C4505	1-100-916-11	CERAMIC CHIP	0.1μF	10%	16V
C3046	1-100-905-11	CERAMIC CHIP	0.001μF	10%	50V	C4506	1-100-916-11	CERAMIC CHIP	0.1μF	10%	16V
C3048	1-100-907-11	CERAMIC CHIP	0.1μF	10%	10V	C4507	1-100-916-11	CERAMIC CHIP	0.1μF	10%	16V
C3049	1-100-905-11	CERAMIC CHIP	0.001μF	10%	50V	C4513	1-100-916-11	CERAMIC CHIP	0.1μF	10%	16V
C3051	1-112-066-11	CERAMIC CHIP	10μF	10%	10V	C4514	1-100-916-11	CERAMIC CHIP	0.1μF	10%	16V
C3052	1-100-907-11	CERAMIC CHIP	0.1μF	10%	10V	C4515	1-100-916-11	CERAMIC CHIP	0.1μF	10%	16V
C3053	1-112-066-11	CERAMIC CHIP	10μF	10%	10V	C4516	1-100-916-11	CERAMIC CHIP	0.1μF	10%	16V
C3057	1-100-907-11	CERAMIC CHIP	0.1μF	10%	10V	C4517	1-100-916-11	CERAMIC CHIP	0.1μF	10%	16V
C3060	1-100-905-11	CERAMIC CHIP	0.001μF	10%	50V	C4518	1-100-916-11	CERAMIC CHIP	0.1μF	10%	16V
C3061	1-100-905-11	CERAMIC CHIP	0.001μF	10%	50V	C4519	1-100-916-11	CERAMIC CHIP	0.1μF	10%	16V
C3062	1-112-066-11	CERAMIC CHIP	10μF	10%	10V	C4520	1-100-916-11	CERAMIC CHIP	0.1μF	10%	16V
C3063	1-100-907-11	CERAMIC CHIP	0.1μF	10%	10V	C4521	1-100-916-11	CERAMIC CHIP	0.1μF	10%	16V
C3066	1-100-907-11	CERAMIC CHIP	0.1μF	10%	10V	C4524	1-100-906-11	CERAMIC CHIP	0.01μF	10%	16V
C3070	1-100-906-11	CERAMIC CHIP	0.01μF	10%	16V	C4525	1-100-905-11	CERAMIC CHIP	0.001μF	10%	50V
C3071	1-164-874-11	CERAMIC CHIP	100pF	5%	50V	C4527	1-100-906-11	CERAMIC CHIP	0.01μF	10%	16V
C3072	1-100-905-11	CERAMIC CHIP	0.001μF	10%	50V	C4528	1-112-774-11	CERAMIC CHIP	470pF	10%	50V
C3074	1-100-907-11	CERAMIC CHIP	0.1μF	10%	10V	C4530	1-100-905-11	CERAMIC CHIP	0.001μF	10%	50V
C3076	1-112-781-11	CERAMIC CHIP	1μF	10%	10V	C4531	1-100-905-11	CERAMIC CHIP	0.001μF	10%	50V
C3079	1-100-907-11	CERAMIC CHIP	0.1μF	10%	10V	C4701	1-100-916-11	CERAMIC CHIP	0.1μF	10%	16V
C3080	1-100-905-11	CERAMIC CHIP	0.001μF	10%	50V	C4702	1-100-916-11	CERAMIC CHIP	0.1μF	10%	16V
C3081	1-112-066-11	CERAMIC CHIP	10μF	10%	10V	C4704	1-112-066-11	CERAMIC CHIP	10μF	10%	10V
C3082	1-112-066-11	CERAMIC CHIP	10μF	10%	10V	C4705	1-100-916-11	CERAMIC CHIP	0.1μF	10%	16V
C3083	1-100-907-11	CERAMIC CHIP	0.1μF	10%	10V	C4708	1-100-905-11	CERAMIC CHIP	0.001μF	10%	50V
C3084	1-100-905-11	CERAMIC CHIP	0.001μF	10%	50V	C4712	1-162-979-11	CERAMIC CHIP	0.0027μF	10%	50V
C3087	1-100-907-11	CERAMIC CHIP	0.1μF	10%	10V	C4713	1-162-979-11	CERAMIC CHIP	0.0027μF	10%	50V
C3110	1-100-916-11	CERAMIC CHIP	0.1μF	10%	16V	C4716	1-100-916-11	CERAMIC CHIP	0.1μF	10%	16V
C3112	1-100-905-11	CERAMIC CHIP	0.001μF	10%	50V	C4717	1-100-916-11	CERAMIC CHIP	0.1μF	10%	16V
C3900	1-164-874-11	CERAMIC CHIP	100pF	5%	50V	C4718	1-100-916-11	CERAMIC CHIP	0.1μF	10%	16V
C4001	1-100-905-11	CERAMIC CHIP	0.001μF	10%	50V	C4720	1-100-905-11	CERAMIC CHIP	0.001μF	10%	50V
C4029	1-100-912-11	CERAMIC CHIP	1μF	10%	25V	C4721	1-100-905-11	CERAMIC CHIP	0.001μF	10%	50V
C4030	1-107-826-11	CERAMIC CHIP	0.1μF	10%	16V	C4722	1-100-905-11	CERAMIC CHIP	0.001μF	10%	50V
C4033	1-112-777-11	CERAMIC CHIP	0.01μF	10%	25V	C4723	1-100-905-11	CERAMIC CHIP	0.001μF	10%	50V
C4034	1-112-046-11	CERAMIC CHIP	4.7μF	10%	6.3V	C4724	1-100-905-11	CERAMIC CHIP	0.001μF	10%	50V
C4035	1-112-777-11	CERAMIC CHIP	0.01μF	10%	25V	C4725	1-164-882-11	CERAMIC CHIP	220pF	5%	16V

BU1

REF. NO.	PART NO.	DESCRIPTION	VALUES			REF. NO.	PART NO.	DESCRIPTION	VALUES		
C4726	1-100-916-11	CERAMIC CHIP	0.1μF	10%	16V	C4917	1-164-874-11	CERAMIC CHIP	100pF	5%	50V
C4730	1-100-905-11	CERAMIC CHIP	0.001μF	10%	50V	C4918	1-164-874-11	CERAMIC CHIP	100pF	5%	50V
C4731	1-100-916-11	CERAMIC CHIP	0.1μF	10%	16V	C4919	1-164-874-11	CERAMIC CHIP	100pF	5%	50V
C4732	1-100-916-11	CERAMIC CHIP	0.1μF	10%	16V	C5002	1-100-916-11	CERAMIC CHIP	0.1μF	10%	16V
C4734	1-100-905-11	CERAMIC CHIP	0.001μF	10%	50V	C5005	1-164-874-11	CERAMIC CHIP	100pF	5%	50V
C4736	1-100-905-11	CERAMIC CHIP	0.001μF	10%	50V	C5006	1-164-874-11	CERAMIC CHIP	100pF	5%	50V
C4739	1-100-916-11	CERAMIC CHIP	0.1μF	10%	16V	C5008	1-112-781-11	CERAMIC CHIP	1μF	10%	10V
C4740	1-100-905-11	CERAMIC CHIP	0.001μF	10%	50V	C5009	1-100-906-11	CERAMIC CHIP	0.01μF	10%	16V
C4741	1-112-066-11	CERAMIC CHIP	10μF	10%	10V	C5502	1-100-916-11	CERAMIC CHIP	0.1μF	10%	16V
C4746	1-100-905-11	CERAMIC CHIP	0.001μF	10%	50V	C5505	1-100-916-11	CERAMIC CHIP	0.1μF	10%	16V
C4750	1-100-905-11	CERAMIC CHIP	0.001μF	10%	50V	C5509	1-112-777-11	CERAMIC CHIP	0.01μF	10%	25V
C4752	1-100-916-11	CERAMIC CHIP	0.1μF	10%	16V	C5510	1-112-777-11	CERAMIC CHIP	0.01μF	10%	25V
C4757	1-100-916-11	CERAMIC CHIP	0.1μF	10%	16V	C5511	1-112-777-11	CERAMIC CHIP	0.01μF	10%	25V
C4758	1-100-916-11	CERAMIC CHIP	0.1μF	10%	16V	C5512	1-112-777-11	CERAMIC CHIP	0.01μF	10%	25V
C4759	1-100-916-11	CERAMIC CHIP	0.1μF	10%	16V	C5513	1-112-777-11	CERAMIC CHIP	0.01μF	10%	25V
C4760	1-100-916-11	CERAMIC CHIP	0.1μF	10%	16V	C5514	1-112-777-11	CERAMIC CHIP	0.01μF	10%	25V
C4762	1-100-916-11	CERAMIC CHIP	0.1μF	10%	16V	C5517	1-112-777-11	CERAMIC CHIP	0.01μF	10%	25V
C4765	1-100-905-11	CERAMIC CHIP	0.001μF	10%	50V	C5518	1-112-777-11	CERAMIC CHIP	0.01μF	10%	25V
C4769	1-100-905-11	CERAMIC CHIP	0.001μF	10%	50V	C5519	1-112-777-11	CERAMIC CHIP	0.01μF	10%	25V
C4773	1-100-905-11	CERAMIC CHIP	0.001μF	10%	50V	C5520	1-112-777-11	CERAMIC CHIP	0.01μF	10%	25V
C4774	1-100-905-11	CERAMIC CHIP	0.001μF	10%	50V	C5521	1-112-777-11	CERAMIC CHIP	0.01μF	10%	25V
C4778	1-100-916-11	CERAMIC CHIP	0.1μF	10%	16V	C5522	1-112-777-11	CERAMIC CHIP	0.01μF	10%	25V
C4779	1-112-781-11	CERAMIC CHIP	1μF	10%	10V	C5523	1-112-777-11	CERAMIC CHIP	0.01μF	10%	25V
C4780	1-100-916-11	CERAMIC CHIP	0.1μF	10%	16V	C5524	1-112-066-11	CERAMIC CHIP	10μF	10%	10V
C4781	1-100-916-11	CERAMIC CHIP	0.1μF	10%	16V	C5525	1-112-777-11	CERAMIC CHIP	0.01μF	10%	25V
C4803	1-112-781-11	CERAMIC CHIP	1μF	10%	10V	C5526	1-112-777-11	CERAMIC CHIP	0.01μF	10%	25V
C4805	1-114-325-11	CERAMIC CHIP	0.1μF	10%	25V	C5527	1-112-777-11	CERAMIC CHIP	0.01μF	10%	25V
C4806	1-126-396-11	ELECT CHIP	47μF	20%	16V	C5528	1-100-916-11	CERAMIC CHIP	0.1μF	10%	16V
C4808	1-162-970-11	CERAMIC CHIP	0.01μF	10%	25V	C5529	1-100-905-11	CERAMIC CHIP	0.001μF	10%	50V
C4813	1-128-396-11	ELECT CHIP	470μF	20%	10V	C5530	1-112-066-11	CERAMIC CHIP	10μF	10%	10V
C4814	1-100-906-11	CERAMIC CHIP	0.01μF	10%	16V	C5531	1-100-916-11	CERAMIC CHIP	0.1μF	10%	16V
C4902	1-100-906-11	CERAMIC CHIP	0.01μF	10%	16V	C5533	1-100-916-11	CERAMIC CHIP	0.1μF	10%	16V
C4903	1-100-916-11	CERAMIC CHIP	0.1μF	10%	16V	C5620	1-100-907-11	CERAMIC CHIP	0.1μF	10%	10V
C4904	1-100-906-11	CERAMIC CHIP	0.01μF	10%	16V	C7000	1-114-334-11	CERAMIC CHIP	10μF	10%	25V
C4906	1-126-392-11	ELECT CHIP	100μF	20%	6.3V	C7001	1-114-334-11	CERAMIC CHIP	10μF	10%	25V
C4907	1-112-776-11	CERAMIC CHIP	0.0047μF	10%	50V	C7002	1-117-681-11	ELECT CHIP	100μF	20%	16V
C4908	1-100-906-11	CERAMIC CHIP	0.01μF	10%	16V	C7003	1-127-573-11	CERAMIC CHIP	1μF	10%	16V
C4909	1-164-874-11	CERAMIC CHIP	100pF	5%	50V	C7004	1-117-681-11	ELECT CHIP	100μF	20%	16V
C4910	1-164-874-11	CERAMIC CHIP	100pF	5%	50V	C7005	1-114-325-11	CERAMIC CHIP	0.1μF	10%	25V
C4911	1-164-874-11	CERAMIC CHIP	100pF	5%	50V	C7006	1-110-648-11	ELECT CHIP	220μF	20%	25V
C4912	1-100-916-11	CERAMIC CHIP	0.1μF	10%	16V	C7007	1-114-334-11	CERAMIC CHIP	10μF	10%	25V
C4913	1-100-916-11	CERAMIC CHIP	0.1μF	10%	16V	C7008	1-100-911-11	CERAMIC CHIP	4.7μF	10%	25V
C4914	1-100-906-11	CERAMIC CHIP	0.01μF	10%	16V	C7009	1-164-862-11	CERAMIC CHIP	33pF	5%	50V
C4915	1-164-874-11	CERAMIC CHIP	100pF	5%	50V	C7010	1-100-911-11	CERAMIC CHIP	4.7μF	10%	25V
C4916	1-164-874-11	CERAMIC CHIP	100pF	5%	50V	C7011	1-164-939-11	CERAMIC CHIP	0.0022μF	10%	50V

BU1

REF. NO.	PART NO.	DESCRIPTION	VALUES			REF. NO.	PART NO.	DESCRIPTION	VALUES		
C7012	1-100-916-11	CERAMIC CHIP	0.1μF	10%	16V	C7059	1-165-908-11	CERAMIC CHIP	1μF	10%	10V
C7013	1-114-214-81	CERAMIC CHIP	470pF	5%	50V	C7060	1-165-908-11	CERAMIC CHIP	1μF	10%	10V
C7015	1-100-905-11	CERAMIC CHIP	0.001μF	10%	50V	C7061	1-114-325-11	CERAMIC CHIP	0.1μF	10%	25V
C7016	1-127-573-11	CERAMIC CHIP	1μF	10%	16V	C7062	1-114-325-11	CERAMIC CHIP	0.1μF	10%	25V
C7017	1-114-325-11	CERAMIC CHIP	0.1μF	10%	25V	C7063	1-165-908-11	CERAMIC CHIP	1μF	10%	10V
C7019	1-114-325-11	CERAMIC CHIP	0.1μF	10%	25V	C7064	1-165-908-11	CERAMIC CHIP	1μF	10%	10V
C7020	1-114-325-11	CERAMIC CHIP	0.1μF	10%	25V	C7065	1-100-912-11	CERAMIC CHIP	1μF	10%	25V
C7021	1-126-210-21	ELECT CHIP	220μF	20%	4V	C7066	1-100-912-11	CERAMIC CHIP	1μF	10%	25V
C7022	1-164-937-11	CERAMIC CHIP	0.001μF	10%	50V	C7067	1-114-325-11	CERAMIC CHIP	0.1μF	10%	25V
C7023	1-100-916-11	CERAMIC CHIP	0.1μF	10%	16V	C7068	1-114-325-11	CERAMIC CHIP	0.1μF	10%	25V
C7024	1-114-325-11	CERAMIC CHIP	0.1μF	10%	25V	C7073	1-114-334-11	CERAMIC CHIP	10μF	10%	25V
C7025	1-165-887-91	CERAMIC CHIP	0.22μF	10%	6.3V	C7074	1-114-334-11	CERAMIC CHIP	10μF	10%	25V
C7026	1-164-874-11	CERAMIC CHIP	100pF	5%	50V	C7075	1-114-334-11	CERAMIC CHIP	10μF	10%	25V
C7027	1-164-862-11	CERAMIC CHIP	33pF	5%	50V	C7076	1-114-334-11	CERAMIC CHIP	10μF	10%	25V
C7028	1-164-862-11	CERAMIC CHIP	33pF	5%	50V	C7077	1-165-908-11	CERAMIC CHIP	1μF	10%	10V
C7029	1-164-937-11	CERAMIC CHIP	0.001μF	10%	50V	C7078	1-165-875-11	CERAMIC CHIP	10μF	10%	10V
C7030	1-164-937-11	CERAMIC CHIP	0.001μF	10%	50V	C7079	1-165-875-11	CERAMIC CHIP	10μF	10%	10V
C7031	1-164-862-11	CERAMIC CHIP	33pF	5%	50V	C7080	1-100-055-11	CERAMIC CHIP	22μF	20%	16V
C7032	1-164-862-11	CERAMIC CHIP	33pF	5%	50V	C7081	1-100-055-11	CERAMIC CHIP	22μF	20%	16V
C7033	1-127-988-81	CERAMIC CHIP	0.015μF	10%	16V	C7086	1-100-916-11	CERAMIC CHIP	0.1μF	10%	16V
C7034	1-164-858-11	CERAMIC CHIP	22pF	5%	50V	C7087	1-100-916-11	CERAMIC CHIP	0.1μF	10%	16V
C7035	1-100-916-11	CERAMIC CHIP	0.1μF	10%	16V	C7088	1-100-916-11	CERAMIC CHIP	0.1μF	10%	16V
C7036	1-164-937-11	CERAMIC CHIP	0.001μF	10%	50V	C7089	1-100-916-11	CERAMIC CHIP	0.1μF	10%	16V
C7037	1-165-887-91	CERAMIC CHIP	0.22μF	10%	6.3V	C7090	1-126-210-21	ELECT CHIP	220μF	20%	4V
C7038	1-127-988-81	CERAMIC CHIP	0.015μF	10%	16V	C7092	1-126-210-21	ELECT CHIP	220μF	20%	4V
C7039	1-127-988-81	CERAMIC CHIP	0.015μF	10%	16V	C7093	1-126-210-21	ELECT CHIP	220μF	20%	4V
C7040	1-164-858-11	CERAMIC CHIP	22pF	5%	50V	C7096	1-126-210-21	ELECT CHIP	220μF	20%	4V
C7041	1-100-916-11	CERAMIC CHIP	0.1μF	10%	16V	C7097	1-125-777-11	CERAMIC CHIP	0.1μF	10%	10V
C7042	1-164-937-11	CERAMIC CHIP	0.001μF	10%	50V	C7098	1-126-210-21	ELECT CHIP	220μF	20%	4V
C7043	1-165-887-91	CERAMIC CHIP	0.22μF	10%	6.3V	C7100	1-100-916-11	CERAMIC CHIP	0.1μF	10%	16V
C7044	1-127-988-81	CERAMIC CHIP	0.015μF	10%	16V	C7101	1-100-507-91	CERAMIC CHIP	4.7μF	20%	6.3V
C7045	1-164-937-11	CERAMIC CHIP	0.001μF	10%	50V	C7102	1-100-507-91	CERAMIC CHIP	4.7μF	20%	6.3V
C7046	1-164-937-11	CERAMIC CHIP	0.001μF	10%	50V	C7103	1-100-507-91	CERAMIC CHIP	4.7μF	20%	6.3V
C7047	1-164-882-11	CERAMIC CHIP	220pF	5%	16V	C7111	1-100-905-11	CERAMIC CHIP	0.001μF	10%	50V
C7048	1-164-882-11	CERAMIC CHIP	220pF	5%	16V	C7146	1-100-055-11	CERAMIC CHIP	22μF	20%	16V
C7049	1-164-882-11	CERAMIC CHIP	220pF	5%	16V	C7147	1-117-681-11	ELECT CHIP	100μF	20%	16V
C7050	1-164-882-11	CERAMIC CHIP	220pF	5%	16V	C7148	1-162-959-11	CERAMIC CHIP	330pF	5%	50V
C7051	1-114-334-11	CERAMIC CHIP	10μF	10%	25V	C7150	1-112-777-11	CERAMIC CHIP	0.01μF	10%	25V
C7052	1-114-334-11	CERAMIC CHIP	10μF	10%	25V	C7200	1-100-583-21	ELECT CHIP	470μF	20%	4V
C7053	1-165-908-11	CERAMIC CHIP	1μF	10%	10V	C7201	1-100-916-11	CERAMIC CHIP	0.1μF	10%	16V
C7054	1-165-908-11	CERAMIC CHIP	1μF	10%	10V	C7202	1-100-916-11	CERAMIC CHIP	0.1μF	10%	16V
C7055	1-165-908-11	CERAMIC CHIP	1μF	10%	10V	C7203	1-100-916-11	CERAMIC CHIP	0.1μF	10%	16V
C7056	1-114-325-11	CERAMIC CHIP	0.1μF	10%	25V	C7204	1-114-130-11	CERAMIC CHIP	1μF		6.3V
C7057	1-114-325-11	CERAMIC CHIP	0.1μF	10%	25V	C7205	1-100-916-11	CERAMIC CHIP	0.1μF	10%	16V
C7058	1-165-908-11	CERAMIC CHIP	1μF	10%	10V	C7206	1-100-916-11	CERAMIC CHIP	0.1μF	10%	16V

BU1

REF. NO.	PART NO.	DESCRIPTION	VALUES			REF. NO.	PART NO.	DESCRIPTION	VALUES		
C7207	1-100-916-11	CERAMIC CHIP	0.1μF	10%	16V	C7252	1-100-916-11	CERAMIC CHIP	0.1μF	10%	16V
C7208	1-126-210-21	ELECT CHIP	220μF	20%	4V	C7253	1-100-916-11	CERAMIC CHIP	0.1μF	10%	16V
C7209	1-100-916-11	CERAMIC CHIP	0.1μF	10%	16V	C7254	1-100-916-11	CERAMIC CHIP	0.1μF	10%	16V
C7210	1-100-916-11	CERAMIC CHIP	0.1μF	10%	16V	C7255	1-114-130-11	CERAMIC CHIP	1μF		6.3V
C7211	1-100-916-11	CERAMIC CHIP	0.1μF	10%	16V	C7256	1-114-130-11	CERAMIC CHIP	1μF		6.3V
C7212	1-100-909-11	CERAMIC CHIP	10μF	10%	6.3V	C7257	1-100-916-11	CERAMIC CHIP	0.1μF	10%	16V
C7213	1-100-916-11	CERAMIC CHIP	0.1μF	10%	16V	C7258	1-100-916-11	CERAMIC CHIP	0.1μF	10%	16V
C7214	1-100-916-11	CERAMIC CHIP	0.1μF	10%	16V	C7259	1-114-130-11	CERAMIC CHIP	1μF		6.3V
C7215	1-100-909-11	CERAMIC CHIP	10μF	10%	6.3V	C7260	1-114-130-11	CERAMIC CHIP	1μF		6.3V
C7216	1-100-583-21	ELECT CHIP	470μF	20%	4V	C7261	1-100-909-11	CERAMIC CHIP	10μF	10%	6.3V
C7217	1-100-916-11	CERAMIC CHIP	0.1μF	10%	16V	C7262	1-114-130-11	CERAMIC CHIP	1μF		6.3V
C7218	1-100-916-11	CERAMIC CHIP	0.1μF	10%	16V	C7263	1-114-130-11	CERAMIC CHIP	1μF		6.3V
C7219	1-100-916-11	CERAMIC CHIP	0.1μF	10%	16V	C7264	1-114-130-11	CERAMIC CHIP	1μF		6.3V
C7220	1-100-909-11	CERAMIC CHIP	10μF	10%	6.3V	C7265	1-100-916-11	CERAMIC CHIP	0.1μF	10%	16V
C7221	1-100-916-11	CERAMIC CHIP	0.1μF	10%	16V	C7266	1-100-916-11	CERAMIC CHIP	0.1μF	10%	16V
C7222	1-100-916-11	CERAMIC CHIP	0.1μF	10%	16V	C7267	1-100-916-11	CERAMIC CHIP	0.1μF	10%	16V
C7223	1-100-909-11	CERAMIC CHIP	10μF	10%	6.3V	C7269	1-100-916-11	CERAMIC CHIP	0.1μF	10%	16V
C7224	1-114-130-11	CERAMIC CHIP	1μF		6.3V	C7270	1-100-916-11	CERAMIC CHIP	0.1μF	10%	16V
C7225	1-114-130-11	CERAMIC CHIP	1μF		6.3V	C7271	1-164-860-11	CERAMIC CHIP	27pF	5%	50V
C7226	1-114-130-11	CERAMIC CHIP	1μF		6.3V	C7272	1-164-860-11	CERAMIC CHIP	27pF	5%	50V
C7227	1-100-916-11	CERAMIC CHIP	0.1μF	10%	16V	C7273	1-165-989-11	CERAMIC CHIP	10μF	10%	6.3V
C7228	1-100-916-11	CERAMIC CHIP	0.1μF	10%	16V	C7274	1-100-909-11	CERAMIC CHIP	10μF	10%	6.3V
C7229	1-114-130-11	CERAMIC CHIP	1μF		6.3V	C7275	1-100-909-11	CERAMIC CHIP	10μF	10%	6.3V
C7230	1-114-130-11	CERAMIC CHIP	1μF		6.3V	C7276	1-100-909-11	CERAMIC CHIP	10μF	10%	6.3V
C7231	1-114-130-11	CERAMIC CHIP	1μF		6.3V	C7277	1-165-989-11	CERAMIC CHIP	10μF	10%	6.3V
C7232	1-114-130-11	CERAMIC CHIP	1μF		6.3V	C7278	1-165-989-11	CERAMIC CHIP	10μF	10%	6.3V
C7233	1-114-130-11	CERAMIC CHIP	1μF		6.3V	C7279	1-114-325-11	CERAMIC CHIP	0.1μF	10%	25V
C7234	1-114-130-11	CERAMIC CHIP	1μF		6.3V	C7280	1-126-210-21	ELECT CHIP	220μF	20%	4V
C7235	1-114-130-11	CERAMIC CHIP	1μF		6.3V	C7300	1-117-681-11	ELECT CHIP	100μF	20%	16V
C7236	1-114-130-11	CERAMIC CHIP	1μF		6.3V	C7301	1-114-325-11	CERAMIC CHIP	0.1μF	10%	25V
C7237	1-114-130-11	CERAMIC CHIP	1μF		6.3V	C7302	1-114-325-11	CERAMIC CHIP	0.1μF	10%	25V
C7238	1-114-130-11	CERAMIC CHIP	1μF		6.3V	C7303	1-112-066-11	CERAMIC CHIP	10μF	10%	10V
C7239	1-114-130-11	CERAMIC CHIP	1μF		6.3V	C7304	1-112-066-11	CERAMIC CHIP	10μF	10%	10V
C7240	1-114-130-11	CERAMIC CHIP	1μF		6.3V	C7305	1-117-681-11	ELECT CHIP	100μF	20%	16V
C7241	1-114-130-11	CERAMIC CHIP	1μF		6.3V	C7306	1-112-777-11	CERAMIC CHIP	0.01μF	10%	25V
C7242	1-100-583-21	ELECT CHIP	470μF	20%	4V	C7400	1-100-916-11	CERAMIC CHIP	0.1μF	10%	16V
C7243	1-100-916-11	CERAMIC CHIP	0.1μF	10%	16V	C7401	1-100-916-11	CERAMIC CHIP	0.1μF	10%	16V
C7244	1-100-916-11	CERAMIC CHIP	0.1μF	10%	16V	C7402	1-100-916-11	CERAMIC CHIP	0.1μF	10%	16V
C7245	1-100-909-11	CERAMIC CHIP	10μF	10%	6.3V	C7403	1-114-130-11	CERAMIC CHIP	1μF		6.3V
C7246	1-100-916-11	CERAMIC CHIP	0.1μF	10%	16V	C7404	1-100-916-11	CERAMIC CHIP	0.1μF	10%	16V
C7247	1-100-916-11	CERAMIC CHIP	0.1μF	10%	16V	C7405	1-100-916-11	CERAMIC CHIP	0.1μF	10%	16V
C7248	1-100-159-91	CERAMIC CHIP	22μF	10%	6.3V	C7406	1-100-916-11	CERAMIC CHIP	0.1μF	10%	16V
C7249	1-100-916-11	CERAMIC CHIP	0.1μF	10%	16V	C7407	1-100-916-11	CERAMIC CHIP	0.1μF	10%	16V
C7250	1-100-916-11	CERAMIC CHIP	0.1μF	10%	16V	C7408	1-100-916-11	CERAMIC CHIP	0.1μF	10%	16V
C7251	1-100-916-11	CERAMIC CHIP	0.1μF	10%	16V	C7409	1-100-916-11	CERAMIC CHIP	0.1μF	10%	16V

BU1

REF. NO.	PART NO.	DESCRIPTION	VALUES			REF. NO.	PART NO.	DESCRIPTION	VALUES		
C7410	1-100-916-11	CERAMIC CHIP	0.1μF	10%	16V	C7720	1-165-908-11	CERAMIC CHIP	1μF	10%	10V
C7411	1-114-130-11	CERAMIC CHIP	1μF		6.3V	C7800	1-100-916-11	CERAMIC CHIP	0.1μF	10%	16V
C7412	1-114-130-11	CERAMIC CHIP	1μF		6.3V	C7801	1-100-916-11	CERAMIC CHIP	0.1μF	10%	16V
C7413	1-114-130-11	CERAMIC CHIP	1μF		6.3V	C7804	1-100-916-11	CERAMIC CHIP	0.1μF	10%	16V
C7417	1-100-916-11	CERAMIC CHIP	0.1μF	10%	16V	C7805	1-100-916-11	CERAMIC CHIP	0.1μF	10%	16V
C7418	1-100-916-11	CERAMIC CHIP	0.1μF	10%	16V	C7807	1-100-916-11	CERAMIC CHIP	0.1μF	10%	16V
C7420	1-100-916-11	CERAMIC CHIP	0.1μF	10%	16V	C7808	1-100-916-11	CERAMIC CHIP	0.1μF	10%	16V
C7422	1-114-130-11	CERAMIC CHIP	1μF		6.3V	C7809	1-100-916-11	CERAMIC CHIP	0.1μF	10%	16V
C7424	1-114-130-11	CERAMIC CHIP	1μF		6.3V	C7810	1-100-916-11	CERAMIC CHIP	0.1μF	10%	16V
C7425	1-114-130-11	CERAMIC CHIP	1μF		6.3V	C7811	1-165-989-11	CERAMIC CHIP	10μF	10%	6.3V
C7430	1-114-325-11	CERAMIC CHIP	0.1μF	10%	25V	C7812	1-100-916-11	CERAMIC CHIP	0.1μF	10%	16V
C7431	1-126-210-21	ELECT CHIP	220μF	20%	4V	C7813	1-100-916-11	CERAMIC CHIP	0.1μF	10%	16V
C7432	1-165-989-11	CERAMIC CHIP	10μF	10%	6.3V	C7814	1-100-916-11	CERAMIC CHIP	0.1μF	10%	16V
C7433	1-165-989-11	CERAMIC CHIP	10μF	10%	6.3V	C7815	1-100-916-11	CERAMIC CHIP	0.1μF	10%	16V
C7501	1-100-916-11	CERAMIC CHIP	0.1μF	10%	16V	C7816	1-165-989-11	CERAMIC CHIP	10μF	10%	6.3V
C7502	1-100-916-11	CERAMIC CHIP	0.1μF	10%	16V	C7817	1-165-989-11	CERAMIC CHIP	10μF	10%	6.3V
C7503	1-100-916-11	CERAMIC CHIP	0.1μF	10%	16V	C7818	1-114-325-11	CERAMIC CHIP	0.1μF	10%	25V
C7504	1-100-916-11	CERAMIC CHIP	0.1μF	10%	16V	C7819	1-114-325-11	CERAMIC CHIP	0.1μF	10%	25V
C7505	1-117-681-11	ELECT CHIP	100μF	20%	16V	C7820	1-164-864-11	CERAMIC CHIP	39pF	5%	50V
C7506	1-117-681-11	ELECT CHIP	100μF	20%	16V	C7821	1-164-858-11	CERAMIC CHIP	22pF	5%	50V
C7507	1-117-681-11	ELECT CHIP	100μF	20%	16V	C7822	1-164-858-11	CERAMIC CHIP	22pF	5%	50V
C7509	1-127-573-11	CERAMIC CHIP	1μF	10%	16V	C7823	1-164-868-11	CERAMIC CHIP	56pF	5%	50V
C7510	1-100-916-11	CERAMIC CHIP	0.1μF	10%	16V	C7824	1-164-868-11	CERAMIC CHIP	56pF	5%	50V
C7511	1-164-937-11	CERAMIC CHIP	0.001μF	10%	50V	C7825	1-164-864-11	CERAMIC CHIP	39pF	5%	50V
C7512	1-100-907-11	CERAMIC CHIP	0.1μF	10%	10V	C7828	1-164-862-11	CERAMIC CHIP	33pF	5%	50V
C7513	1-126-210-21	ELECT CHIP	220μF	20%	4V	C7829	1-164-862-11	CERAMIC CHIP	33pF	5%	50V
C7514	1-165-875-11	CERAMIC CHIP	10μF	10%	10V	C7831	1-107-819-11	CERAMIC CHIP	0.022μF	10%	16V
C7515	1-100-916-11	CERAMIC CHIP	0.1μF	10%	16V	C7832	1-137-765-21	ELECT CHIP	47μF	20%	16V
C7516	1-100-916-11	CERAMIC CHIP	0.1μF	10%	16V	C7833	1-100-907-11	CERAMIC CHIP	0.1μF	10%	10V
C7600	1-100-916-11	CERAMIC CHIP	0.1μF	10%	16V	C7834	1-126-396-11	ELECT CHIP	47μF	20%	16V
C7603	1-100-916-11	CERAMIC CHIP	0.1μF	10%	16V	C7835	1-164-860-11	CERAMIC CHIP	27pF	5%	50V
C7604	1-100-916-11	CERAMIC CHIP	0.1μF	10%	16V	C7836	1-164-860-11	CERAMIC CHIP	27pF	5%	50V
C7607	1-100-916-11	CERAMIC CHIP	0.1μF	10%	16V	C7837	1-164-840-11	CERAMIC CHIP	1pF	0.25pF	50V
C7609	1-100-916-11	CERAMIC CHIP	0.1μF	10%	16V	C7838	1-164-840-11	CERAMIC CHIP	1pF	0.25pF	50V
C7610	1-100-916-11	CERAMIC CHIP	0.1μF	10%	16V	C7839	1-100-916-11	CERAMIC CHIP	0.1μF	10%	16V
C7611	1-112-781-11	CERAMIC CHIP	1μF	10%	10V	C7840	1-164-860-11	CERAMIC CHIP	27pF	5%	50V
C7612	1-112-781-11	CERAMIC CHIP	1μF	10%	10V	C7841	1-164-860-11	CERAMIC CHIP	27pF	5%	50V
C7700	1-100-916-11	CERAMIC CHIP	0.1μF	10%	16V	C7842	1-100-581-81	CERAMIC CHIP	0.0047μF	10%	50V
C7701	1-100-916-11	CERAMIC CHIP	0.1μF	10%	16V	C7844	1-117-681-11	ELECT CHIP	100μF	20%	16V
C7702	1-100-916-11	CERAMIC CHIP	0.1μF	10%	16V	C7845	1-100-916-11	CERAMIC CHIP	0.1μF	10%	16V
C7703	1-100-916-11	CERAMIC CHIP	0.1μF	10%	16V	C7846	1-137-765-21	ELECT CHIP	47μF	20%	16V
C7704	1-100-916-11	CERAMIC CHIP	0.1μF	10%	16V	C7847	1-164-939-11	CERAMIC CHIP	0.0022μF	10%	50V
C7705	1-100-916-11	CERAMIC CHIP	0.1μF	10%	16V	C7848	1-114-183-11	ELECT CHIP	1000μF	20%	6.3V
C7706	1-100-916-11	CERAMIC CHIP	0.1μF	10%	16V	C7849	1-112-777-11	CERAMIC CHIP	0.01μF	10%	25V
C7707	1-100-916-11	CERAMIC CHIP	0.1μF	10%	16V	C7850	1-100-905-11	CERAMIC CHIP	0.001μF	10%	50V

NOTE: The components identified by shading and \triangle mark are critical for safety. Replace only with part number specified.

NOTE: Les composants identifiés par un trame et une marque \triangle sont critiques pour la sécurité. Ne les remplacer que par une pièce portant le numéro spécifié.

BU1

REF. NO.	PART NO.	DESCRIPTION	VALUES	REF. NO.	PART NO.	DESCRIPTION	VALUES
C7852	1-128-396-11	ELECT CHIP	470 μ F 20% 10V	D2023	8-719-404-50	DIODE	MA111-TX
C7853	1-112-777-11	CERAMIC CHIP	0.01 μ F 10% 25V	D3002	8-719-071-87	DIODE	MA785-(TX),SO
C7854	1-112-777-11	CERAMIC CHIP	0.01 μ F 10% 25V	D3006	8-719-404-50	DIODE	MA111-TX
C7855	1-165-887-91	CERAMIC CHIP	0.22 μ F 10% 6.3V	D3007	8-719-077-59	DIODE	1PS302
C7856	1-100-905-11	CERAMIC CHIP	0.001 μ F 10% 50V	D3020	8-719-422-46	DIODE	MA8056
C7857	1-100-159-91	CERAMIC CHIP	22 μ F 10% 6.3V	D3021	8-719-422-46	DIODE	MA8056
C7858	1-164-874-11	CERAMIC CHIP	100pF 5% 50V	D4012	8-719-017-89	DIODE	MA8150-TX
C7859	1-164-874-11	CERAMIC CHIP	100pF 5% 50V	D5000	8-719-422-46	DIODE	MA8056
C7861	1-112-781-11	CERAMIC CHIP	1 μ F 10% 10V	D5001	8-719-422-46	DIODE	MA8056
C7862	1-112-046-11	CERAMIC CHIP	4.7 μ F 10% 6.3V	D5002	8-719-422-46	DIODE	MA8056
C7863	1-100-916-11	CERAMIC CHIP	0.1 μ F 10% 16V	D5003	8-719-050-38	DIODE	M1MA152WK-T1
C7864	1-100-916-11	CERAMIC CHIP	0.1 μ F 10% 16V	D5508	8-719-404-50	DIODE	MA111-TX
C7867	1-164-862-11	CERAMIC CHIP	33pF 5% 50V	D5516	8-719-404-50	DIODE	MA111-TX
C7869	1-164-882-11	CERAMIC CHIP	220pF 5% 16V	D5525	8-719-404-50	DIODE	MA111-TX
C7870	1-165-989-11	CERAMIC CHIP	10 μ F 10% 6.3V	D5528	8-719-404-50	DIODE	MA111-TX
C7871	1-165-989-11	CERAMIC CHIP	10 μ F 10% 6.3V	D5620	6-500-813-01	DIODE	MA2SD32008S0
C7878	1-128-396-11	ELECT CHIP	470 μ F 20% 10V	D7001	8-719-404-50	DIODE	MA111-TX
C7879	1-100-906-11	CERAMIC CHIP	0.01 μ F 10% 16V	D7003	8-719-423-10	DIODE	MA8100-M-TX
C7880	1-100-905-11	CERAMIC CHIP	0.001 μ F 10% 50V	D7004	8-719-977-12	DIODE	DTZ6.8B
C7950	1-112-777-11	CERAMIC CHIP	0.01 μ F 10% 25V	D7008	8-719-421-24	DIODE	MA8039-H
C7951	1-112-777-11	CERAMIC CHIP	0.01 μ F 10% 25V	D7009	8-719-404-50	DIODE	MA111-TX
C7952	1-112-781-11	CERAMIC CHIP	1 μ F 10% 10V	D7010	8-719-081-34	DIODE	RB160M-30TR
C7953	1-112-779-11	CERAMIC CHIP	0.047 μ F 10% 25V	D7013	8-719-081-34	DIODE	RB160M-30TR
CONNECTOR				D7020	6-501-336-01	DIODE	RSX201L-30TE25
* CN1400	1-819-928-11	HEADER ASSEMBLY	20P	D7022	8-719-422-46	DIODE	MA8056
* CN2000	1-819-461-11	HEADER ASSEMBLY FOR PWB		D7500	8-719-073-34	DIODE	EC21QS03L-TE12L
CN3003	1-779-331-51	CONNECTOR, FFC/FPC	14P	D7700	8-719-053-07	DIODE	SML-310MTT86
CN3004	1-779-936-51	CONNECTOR, FFC/FPC	18P	D7801	8-719-058-24	DIODE	RB501V-40TE-17
* CN3008	1-819-928-11	HEADER ASSEMBLY	20P	EARTH TERMINAL			
* CN4001	1-820-550-11	HEADER ASSEMBLY FOR PWB		ET2000	1-780-521-11	CAPACITOR PROTECTOR	
* CN4003	1-819-333-11	HEADER ASSEMBLY FOR PWB		ET4001	1-780-482-11	EARTH TERMINAL	
CN7304	1-817-109-11	CONNECTOR, USB (A)		ET4002	1-780-482-11	EARTH TERMINAL	
DIODE				ET4003	1-780-482-11	EARTH TERMINAL	
D1000	8-719-423-03	DIODE	MA8100	ET4004	1-780-482-11	EARTH TERMINAL	
D1001	8-719-423-03	DIODE	MA8100	ET4005	1-780-482-11	EARTH TERMINAL	
D1002	8-719-423-03	DIODE	MA8100	ET4006	1-780-482-11	EARTH TERMINAL	
D1003	8-719-423-03	DIODE	MA8100	ET4007	1-780-482-11	EARTH TERMINAL	
D1006	8-719-423-03	DIODE	MA8100	ET7000	1-780-521-11	CAPACITOR PROTECTOR	
\triangle D2014	8-719-422-97	DIODE	MA8091-M	ET7001	1-780-521-11	CAPACITOR PROTECTOR	
\triangle D2018	8-719-422-46	DIODE	MA8056	FUSE			
\triangle D2019	8-719-422-46	DIODE	MA8056	\triangle F2000	1-576-958-21	FUSE	4A 24V
\triangle D2020	8-719-422-46	DIODE	MA8056	\triangle F2001	1-576-913-11	FUSE	1.6A 32V
\triangle D2021	8-719-422-46	DIODE	MA8056	\triangle F2002	1-576-646-11	FUSE	0.5A 50V

NOTE: The components identified by shading and \triangle mark are critical for safety. Replace only with part number specified.

NOTE: Les composants identifiés par un trame et une marque \triangle sont critiques pour la sécurité. Ne les remplacer que par une pièce portant le numéro spécifié.

BU1

REF. NO.	PART NO.	DESCRIPTION	VALUES	REF. NO.	PART NO.	DESCRIPTION	VALUES
\triangle F3001	1-576-646-11	FUSE	0.5A 50V	FB7001	1-400-794-21	FERRITE	0 μ H
\triangle F4005	1-576-933-21	FUSE	5A 24V	FB7023	1-400-772-21	FERRITE	0 μ H
\triangle F7000	1-576-603-21	FUSE	3.15A 24V	\triangle FB7200	1-414-229-11	FERRITE	0 μ H
\triangle F7001	1-576-603-21	FUSE	3.15A 24V	\triangle FB7201	1-414-229-11	FERRITE	0 μ H
\triangle F7002	1-576-913-11	FUSE	1.6A 32V	FB7203	1-400-110-21	FERRITE	0 μ H
FERRITE BEAD				FB7204	1-400-110-21	FERRITE	0 μ H
FB1400	1-400-807-21	FERRITE	0 μ H	FB7300	1-400-089-21	FERRITE	0 μ H
FB1401	1-400-807-21	FERRITE	0 μ H	FB7301	1-400-089-21	FERRITE	0 μ H
FB2006	1-400-089-21	FERRITE	0 μ H	FB7400	1-400-110-21	FERRITE	0 μ H
FB2007	1-400-089-21	FERRITE	0 μ H	FB7601	1-469-083-21	FERRITE	0 μ H
FB2008	1-400-089-21	FERRITE	0 μ H	\triangle FB7602	1-469-083-21	FERRITE	0 μ H
FB2009	1-400-089-21	FERRITE	0 μ H	\triangle FB7700	1-414-229-11	FERRITE	0 μ H
FB2012	1-400-807-21	FERRITE	0 μ H	\triangle FB7701	1-414-229-11	FERRITE	0 μ H
FB2015	1-400-212-22	FERRITE	0 μ H	FB7800	1-414-229-11	FERRITE	0 μ H
FB2016	1-400-110-21	FERRITE	0 μ H	FB7801	1-218-990-81	SHORT CHIP	
FB2017	1-400-807-21	FERRITE	0 μ H	FB7802	1-218-990-81	SHORT CHIP	
FB2018	1-400-807-21	FERRITE	0 μ H	FB7803	1-469-084-21	FERRITE	0MH
FB2019	1-400-807-21	FERRITE	0 μ H	\triangle FB7804	1-469-083-21	FERRITE	0 μ H
FB4001	1-400-089-21	FERRITE	0 μ H	FB7805	1-469-083-21	FERRITE	0 μ H
FB4003	1-400-089-21	FERRITE	0 μ H	FB7806	1-469-083-21	FERRITE	0 μ H
FB4005	1-414-445-11	FERRITE	0 μ H	FB7807	1-469-083-21	FERRITE	0 μ H
FB4006	1-414-445-11	FERRITE	0 μ H	FB7808	1-400-198-21	FERRITE	0 μ H
FB4007	1-414-445-11	FERRITE	0 μ H	FB7809	1-400-198-21	FERRITE	0 μ H
FB4008	1-400-591-22	FERRITE	0 μ H	FILTER			
FB4009	1-400-591-22	FERRITE	0 μ H	FL3001	1-234-177-21	FERRITE	0 μ H
FB4010	1-400-591-22	FERRITE	0 μ H	FL4701	1-234-177-21	FERRITE	0 μ H
FB4011	1-400-591-22	FERRITE	0 μ H	FL4703	1-234-177-21	FERRITE	0 μ H
\triangle FB4056	1-414-445-11	FERRITE	0 μ H	FL4705	1-234-177-21	FERRITE	0 μ H
FB4501	1-469-669-21	FERRITE	0 μ H	FL4706	1-234-177-21	FERRITE	0 μ H
FB4701	1-400-794-21	FERRITE	0 μ H	FL4707	1-234-177-21	FERRITE	0 μ H
FB4702	1-400-110-21	FERRITE	0 μ H	FL4900	1-234-177-21	FERRITE	0 μ H
FB4703	1-400-110-21	FERRITE	0 μ H	FL4901	1-234-177-21	FERRITE	0 μ H
FB4705	1-400-110-21	FERRITE	0 μ H	FL5501	1-234-177-21	FERRITE	0 μ H
FB4706	1-400-110-21	FERRITE	0 μ H	FL5502	1-234-177-21	FERRITE	0 μ H
FB4744	1-400-772-21	FERRITE	0 μ H	IC			
FB5000	1-469-100-21	FERRITE	0 μ H	IC2002	6-710-906-01	IC	CXD9890Q
FB5001	1-469-100-21	FERRITE	0 μ H	IC2004	8-759-278-58	IC	NJM4558V-TE2
FB5002	1-469-100-21	FERRITE	0 μ H	IC2005	6-708-762-01	IC	PQ200WNA1ZPH
FB5004	1-469-100-21	FERRITE	0 μ H	IC2006	8-759-278-58	IC	NJM4558V-TE2
FB5005	1-400-110-21	FERRITE	0 μ H	IC2008	6-709-927-01	IC	RT8H225C-TP-2
FB5006	1-469-100-21	FERRITE	0 μ H	\triangle IC2009	6-710-904-01	IC	TPA3100D2PHPR
FB5501	1-469-100-21	FERRITE	0 μ H	IC2010	8-759-359-49	IC	NJM3414AV(TE2)
FB7000	1-400-794-21	FERRITE	0 μ H	IC2011	6-709-927-01	IC	RT8H225C-TP-2

NOTE: The components identified by shading and \triangle mark are critical for safety. Replace only with part number specified.

NOTE: Les composants identifiés par un trame et une marque \triangle sont critiques pour la sécurité. Ne les remplacer que par une pièce portant le numéro spécifié.

BU1

REF. NO.	PART NO.	DESCRIPTION	VALUES	REF. NO.	PART NO.	DESCRIPTION	VALUES
L7006	1-400-325-11	INDUCTOR	5.6 μ H	Q2026	6-551-677-01	TRANSISTOR	RTAN140M-T111-1
L7007	1-400-281-11	INDUCTOR	10 μ H	Q2029	8-729-028-96	TRANSISTOR	DTC114EUA-T106
L7008	1-481-080-11	INDUCTOR	22 μ H	Q2030	8-729-028-96	TRANSISTOR	DTC114EUA-T106
L7201	1-400-180-21	FERRITE	0 μ H	Q2031	8-729-028-96	TRANSISTOR	DTC114EUA-T106
L7300	1-400-284-21	INDUCTOR	0 μ H	Q2032	8-729-028-96	TRANSISTOR	DTC114EUA-T106
L7431	1-400-180-21	FERRITE	0 μ H	Q2045	6-551-677-01	TRANSISTOR	RTAN140M-T111-1
L7720	1-400-180-21	FERRITE	0 μ H	Q2046	6-551-677-01	TRANSISTOR	RTAN140M-T111-1
L7800	1-412-973-11	INDUCTOR	0.33 μ H	Q3002	6-551-420-01	TRANSISTOR	RT1N151M-TP-1
L7801	1-412-971-31	INDUCTOR	0.22 μ H	Q3003	8-729-028-74	TRANSISTOR	DTA114TUA-T106
L7802	1-412-971-31	INDUCTOR	0.22 μ H	Q3004	8-729-013-28	TRANSISTOR	HN1B01FU-TE85R
L7805	1-412-973-11	INDUCTOR	0.33 μ H	Q3005	8-729-028-74	TRANSISTOR	DTA114TUA-T106
L7806	1-412-974-41	INDUCTOR	0.39 μ H	Q3006	6-550-260-01	TRANSISTOR	RT1N237M-TP-1
L7807	1-412-974-41	INDUCTOR	0.39 μ H	Q3007	8-729-028-96	TRANSISTOR	DTC114EUA-T106
L7808	1-469-555-21	INDUCTOR	10 μ H	Q3008	6-551-424-01	TRANSISTOR	RT1P151M-TP-1
L7809	1-412-972-31	INDUCTOR	0.27 μ H	Q3010	8-729-029-06	TRANSISTOR	DTC124EUA-T106
L7810	1-412-972-31	INDUCTOR	0.27 μ H	Q4001	8-729-028-97	TRANSISTOR	DTC114TUA-T106
L7811	1-469-555-21	INDUCTOR	10 μ H	Q4002	8-729-028-97	TRANSISTOR	DTC114TUA-T106
L7812	1-469-555-21	INDUCTOR	10 μ H	Q4011	8-729-907-00	TRANSISTOR	DTC114EU
L7813	1-469-555-21	INDUCTOR	10 μ H	\triangle Q4012	8-729-054-36	TRANSISTOR	UPA1716G-E2
L7814	1-469-555-21	INDUCTOR	10 μ H	Q4014	8-729-028-96	TRANSISTOR	DTC114EUA-T106
L7815	1-216-295-91	SHORT CHIP		Q4015	8-729-028-96	TRANSISTOR	DTC114EUA-T106
L7817	1-400-180-21	FERRITE	0 μ H	Q4016	8-729-028-97	TRANSISTOR	DTC114TUA-T106
L7818	1-400-180-21	FERRITE	0 μ H	Q4017	8-729-028-97	TRANSISTOR	DTC114TUA-T106
L7819	1-469-555-21	INDUCTOR	10 μ H	Q4018	8-729-028-97	TRANSISTOR	DTC114TUA-T106
				Q4019	8-729-028-97	TRANSISTOR	DTC114TUA-T106
	IC LINK			Q4800	6-551-696-01	TRANSISTOR	ISA1235AC1TP-1EF
PS5000	1-576-646-11	FUSE	0.5A 50V	Q4801	6-551-696-01	TRANSISTOR	ISA1235AC1TP-1EF
	TRANSISTOR			Q5503	8-729-028-28	TRANSISTOR	2SK2036(TE85L)
Q2006	8-729-028-96	TRANSISTOR	DTC114EUA-T106	Q5505	8-729-028-28	TRANSISTOR	2SK2036(TE85L)
Q2007	6-551-677-01	TRANSISTOR	RTAN140M-T111-1	Q5507	8-729-028-96	TRANSISTOR	DTC114EUA-T106
Q2008	6-551-677-01	TRANSISTOR	RTAN140M-T111-1	Q5509	8-729-028-96	TRANSISTOR	DTC114EUA-T106
Q2009	8-729-028-96	TRANSISTOR	DTC114EUA-T106	Q5510	8-729-028-96	TRANSISTOR	DTC114EUA-T106
\triangle Q2010	8-729-013-28	TRANSISTOR	HN1B01FU-TE85R	Q5620	6-551-699-01	TRANSISTOR	ISA1602AM1TP-1EF
Q2012	6-551-271-01	TRANSISTOR	RT3AMMM	Q5621	8-729-620-13	TRANSISTOR	2SC4154TP-1EF
Q2013	6-551-271-01	TRANSISTOR	RT3AMMM	Q5622	8-729-620-13	TRANSISTOR	2SC4154TP-1EF
Q2016	8-729-028-96	TRANSISTOR	DTC114EUA-T106	Q5623	8-729-028-96	TRANSISTOR	DTC114EUA-T106
Q2017	8-729-028-96	TRANSISTOR	DTC114EUA-T106	\triangle Q7000	8-729-046-04	TRANSISTOR	FDS6690A
Q2018	8-729-028-97	TRANSISTOR	DTC114TUA-T106	Q7001	6-709-438-01	TRANSISTOR	FDS6986AS-NL
Q2019	6-551-677-01	TRANSISTOR	RTAN140M-T111-1	\triangle Q7002	6-709-438-01	TRANSISTOR	FDS6986AS-NL
Q2020	6-551-677-01	TRANSISTOR	RTAN140M-T111-1	\triangle Q7003	6-709-438-01	TRANSISTOR	FDS6986AS-NL
Q2023	8-729-028-96	TRANSISTOR	DTC114EUA-T106	\triangle Q7004	6-709-438-01	TRANSISTOR	FDS6986AS-NL
Q2024	8-729-028-91	TRANSISTOR	DTA144EUA-T106	Q7007	8-729-620-07	TRANSISTOR	2SC3052EF-T1-LEF
Q2025	6-551-677-01	TRANSISTOR	RTAN140M-T111-1	Q7008	8-729-620-07	TRANSISTOR	2SC3052EF-T1-LEF
				\triangle Q7009	6-550-828-01	TRANSISTOR	RSQ035P03TR
				Q7800	6-551-696-01	TRANSISTOR	ISA1235AC1TP-1EF

BU1

REF. NO.	PART NO.	DESCRIPTION	VALUES			REF. NO.	PART NO.	DESCRIPTION	VALUES		
Q7801	8-729-620-13	TRANSISTOR	2SC4154TP-1EF			R1111	1-218-831-11	METAL CHIP	220	0.50%	1/10W
Q7802	6-551-699-01	TRANSISTOR	ISA1602AM1TP-1EF			R1112	1-218-831-11	METAL CHIP	220	0.50%	1/10W
Q7803	8-729-620-07	TRANSISTOR	2SC3052EF-T1-LEF			R1113	1-218-933-11	RES-CHIP	22	5%	1/16W
Q7804	8-729-620-07	TRANSISTOR	2SC3052EF-T1-LEF			R1114	1-218-957-11	RES-CHIP	2.2K	5%	1/16W
Q7805	6-551-699-01	TRANSISTOR	ISA1602AM1TP-1EF			R1115	1-218-989-11	RES-CHIP	1M	5%	1/16W
Q7806	8-729-620-13	TRANSISTOR	2SC4154TP-1EF			R1116	1-218-957-11	RES-CHIP	2.2K	5%	1/16W
						R1117	1-218-989-11	RES-CHIP	1M	5%	1/16W
						R1132	1-218-831-11	METAL CHIP	220	0.50%	1/10W
						R1133	1-218-831-11	METAL CHIP	220	0.50%	1/10W
						R1134	1-218-831-11	METAL CHIP	220	0.50%	1/10W
						R1135	1-218-933-11	RES-CHIP	22	5%	1/16W
						R1136	1-218-831-11	METAL CHIP	220	0.50%	1/10W
						R1137	1-218-831-11	METAL CHIP	220	0.50%	1/10W
						R1138	1-218-831-11	METAL CHIP	220	0.50%	1/10W
						R1139	1-218-933-11	RES-CHIP	22	5%	1/16W
						R1140	1-218-831-11	METAL CHIP	220	0.50%	1/10W
						R1141	1-218-831-11	METAL CHIP	220	0.50%	1/10W
						R1142	1-218-831-11	METAL CHIP	220	0.50%	1/10W
						R1143	1-218-933-11	RES-CHIP	22	5%	1/16W
						R1144	1-218-957-11	RES-CHIP	2.2K	5%	1/16W
						R1145	1-218-989-11	RES-CHIP	1M	5%	1/16W
						R1146	1-218-957-11	RES-CHIP	2.2K	5%	1/16W
						R1147	1-218-989-11	RES-CHIP	1M	5%	1/16W
						R1402	1-218-990-81	SHORT CHIP			
						R1403	1-218-990-81	SHORT CHIP			
						R1406	1-218-990-81	SHORT CHIP			
						R1409	1-218-990-81	SHORT CHIP			
						R1410	1-218-990-81	SHORT CHIP			
						R1411	1-218-990-81	SHORT CHIP			
						R1412	1-218-990-81	SHORT CHIP			
						R1413	1-218-990-81	SHORT CHIP			
						R1700	1-218-981-11	RES-CHIP	220K	5%	1/16W
						R1701	1-218-981-11	RES-CHIP	220K	5%	1/16W
						R1702	1-218-957-11	RES-CHIP	2.2K	5%	1/16W
						R1703	1-218-957-11	RES-CHIP	2.2K	5%	1/16W
						R1710	1-218-989-11	RES-CHIP	1M	5%	1/16W
						R1711	1-218-989-11	RES-CHIP	1M	5%	1/16W
						R1712	1-218-957-11	RES-CHIP	2.2K	5%	1/16W
						R1713	1-218-957-11	RES-CHIP	2.2K	5%	1/16W
						R1720	1-218-989-11	RES-CHIP	1M	5%	1/16W
						R1721	1-218-989-11	RES-CHIP	1M	5%	1/16W
						R1722	1-218-957-11	RES-CHIP	2.2K	5%	1/16W
						R1723	1-218-957-11	RES-CHIP	2.2K	5%	1/16W
						R2020	1-218-965-11	RES-CHIP	10K	5%	1/16W
						R2023	1-218-990-81	SHORT CHIP			

BU1

REF. NO.	PART NO.	DESCRIPTION	VALUES			REF. NO.	PART NO.	DESCRIPTION	VALUES		
R2026	1-218-937-11	RES-CHIP	47	5%	1/16W	R2122	1-208-715-11	METAL CHIP	22K	0.50%	1/16W
R2033	1-218-941-81	RES-CHIP	100	5%	1/16W	R2126	1-208-927-11	METAL CHIP	47K	0.50%	1/16W
R2035	1-218-937-11	RES-CHIP	47	5%	1/16W	R2129	1-208-715-11	METAL CHIP	22K	0.50%	1/16W
R2042	1-218-937-11	RES-CHIP	47	5%	1/16W	R2130	1-208-697-11	METAL CHIP	3.9K	0.50%	1/16W
R2044	1-218-941-81	RES-CHIP	100	5%	1/16W	R2131	1-208-697-11	METAL CHIP	3.9K	0.50%	1/16W
R2049	1-218-990-81	SHORT CHIP				R2133	1-208-715-11	METAL CHIP	22K	0.50%	1/16W
R2050	1-218-989-11	RES-CHIP	1M	5%	1/16W	R2138	1-218-985-11	RES-CHIP	470K	5%	1/16W
R2056	1-218-963-11	RES-CHIP	6.8K	5%	1/16W	R2139	1-218-985-11	RES-CHIP	470K	5%	1/16W
R2057	1-218-963-11	RES-CHIP	6.8K	5%	1/16W	R2141	1-218-953-11	RES-CHIP	1K	5%	1/16W
R2063	1-218-990-81	SHORT CHIP				R2142	1-218-953-11	RES-CHIP	1K	5%	1/16W
R2064	1-218-965-11	RES-CHIP	10K	5%	1/16W	R2143	1-208-711-11	METAL CHIP	15K	0.50%	1/16W
R2070	1-218-990-81	SHORT CHIP				R2145	1-208-711-11	METAL CHIP	15K	0.50%	1/16W
R2073	1-218-941-81	RES-CHIP	100	5%	1/16W	R2147	1-218-953-11	RES-CHIP	1K	5%	1/16W
R2074	1-218-953-11	RES-CHIP	1K	5%	1/16W	R2148	1-218-973-11	RES-CHIP	47K	5%	1/16W
R2075	1-218-937-11	RES-CHIP	47	5%	1/16W	R2149	1-218-969-11	RES-CHIP	22K	5%	1/16W
R2076	1-218-937-11	RES-CHIP	47	5%	1/16W	R2150	1-218-969-11	RES-CHIP	22K	5%	1/16W
R2077	1-218-937-11	RES-CHIP	47	5%	1/16W	R2151	1-218-973-11	RES-CHIP	47K	5%	1/16W
R2078	1-218-937-11	RES-CHIP	47	5%	1/16W	R2153	1-218-977-11	RES-CHIP	100K	5%	1/16W
R2085	1-218-971-11	RES-CHIP	33K	5%	1/16W	R2154	1-218-990-81	SHORT CHIP			
R2087	1-218-971-11	RES-CHIP	33K	5%	1/16W	R2155	1-218-990-81	SHORT CHIP			
R2091	1-218-971-11	RES-CHIP	33K	5%	1/16W	R2156	1-218-990-81	SHORT CHIP			
R2092	1-218-971-11	RES-CHIP	33K	5%	1/16W	R2162	1-218-977-11	RES-CHIP	100K	5%	1/16W
R2095	1-220-199-81	RES-CHIP	24K	5%	1/16W	R2163	1-218-973-11	RES-CHIP	47K	5%	1/16W
R2096	1-218-971-11	RES-CHIP	33K	5%	1/16W	R2166	1-218-965-11	RES-CHIP	10K	5%	1/16W
R2097	1-218-971-11	RES-CHIP	33K	5%	1/16W	R2167	1-218-965-11	RES-CHIP	10K	5%	1/16W
R2098	1-218-965-11	RES-CHIP	10K	5%	1/16W	R2168	1-218-961-11	RES-CHIP	4.7K	5%	1/16W
R2099	1-218-965-11	RES-CHIP	10K	5%	1/16W	R2169	1-218-973-11	RES-CHIP	47K	5%	1/16W
R2100	1-218-971-11	RES-CHIP	33K	5%	1/16W	R2170	1-218-961-11	RES-CHIP	4.7K	5%	1/16W
R2101	1-218-971-11	RES-CHIP	33K	5%	1/16W	R2171	1-218-961-11	RES-CHIP	4.7K	5%	1/16W
R2102	1-218-971-11	RES-CHIP	33K	5%	1/16W	R2176	1-218-973-11	RES-CHIP	47K	5%	1/16W
R2103	1-218-971-11	RES-CHIP	33K	5%	1/16W	R2177	1-218-977-11	RES-CHIP	100K	5%	1/16W
R2104	1-218-971-11	RES-CHIP	33K	5%	1/16W	R2178	1-218-977-11	RES-CHIP	100K	5%	1/16W
R2105	1-218-971-11	RES-CHIP	33K	5%	1/16W	R2179	1-208-935-11	METAL CHIP	100K	0.50%	1/16W
R2106	1-218-971-11	RES-CHIP	33K	5%	1/16W	R2180	1-218-961-11	RES-CHIP	4.7K	5%	1/16W
R2107	1-218-971-11	RES-CHIP	33K	5%	1/16W	R2181	1-208-935-11	METAL CHIP	100K	0.50%	1/16W
R2108	1-218-971-11	RES-CHIP	33K	5%	1/16W	R2184	1-218-965-11	RES-CHIP	10K	5%	1/16W
R2109	1-218-971-11	RES-CHIP	33K	5%	1/16W	R2185	1-218-965-11	RES-CHIP	10K	5%	1/16W
R2110	1-208-691-11	METAL CHIP	2.2K	0.50%	1/16W	R2186	1-218-839-11	METAL CHIP	470	0.50%	1/10W
R2111	1-208-691-11	METAL CHIP	2.2K	0.50%	1/16W	R2187	1-218-839-11	METAL CHIP	470	0.50%	1/10W
R2112	1-208-715-11	METAL CHIP	22K	0.50%	1/16W	R2198	1-218-963-11	RES-CHIP	6.8K	5%	1/16W
R2113	1-208-715-11	METAL CHIP	22K	0.50%	1/16W	R2199	1-218-977-11	RES-CHIP	100K	5%	1/16W
R2117	1-218-961-11	RES-CHIP	4.7K	5%	1/16W	R2200	1-218-977-11	RES-CHIP	100K	5%	1/16W
R2118	1-218-961-11	RES-CHIP	4.7K	5%	1/16W	R2202	1-218-965-11	RES-CHIP	10K	5%	1/16W
R2120	1-208-927-11	METAL CHIP	47K	0.50%	1/16W	R2204	1-218-977-11	RES-CHIP	100K	5%	1/16W
R2121	1-208-715-11	METAL CHIP	22K	0.50%	1/16W	R2205	1-208-923-11	METAL CHIP	33K	0.50%	1/16W

BU1

REF. NO.	PART NO.	DESCRIPTION	VALUES			REF. NO.	PART NO.	DESCRIPTION	VALUES		
R2207	1-218-937-11	RES-CHIP	47	5%	1/16W	R3052	1-218-941-81	RES-CHIP	100	5%	1/16W
R2210	1-208-703-11	METAL CHIP	6.8K	0.50%	1/16W	R3053	1-218-990-81	SHORT CHIP			
R2211	1-208-703-11	METAL CHIP	6.8K	0.50%	1/16W	R3055	1-218-973-11	RES-CHIP	47K	5%	1/16W
R2212	1-208-711-11	METAL CHIP	15K	0.50%	1/16W	R3061	1-218-965-11	RES-CHIP	10K	5%	1/16W
R2213	1-208-711-11	METAL CHIP	15K	0.50%	1/16W	R3066	1-218-965-11	RES-CHIP	10K	5%	1/16W
R2227	1-208-691-11	METAL CHIP	2.2K	0.50%	1/16W	R3069	1-218-941-81	RES-CHIP	100	5%	1/16W
R2228	1-208-703-11	METAL CHIP	6.8K	0.50%	1/16W	R3070	1-218-941-81	RES-CHIP	100	5%	1/16W
R2229	1-208-683-11	METAL CHIP	1K	0.50%	1/16W	R3101	1-218-959-11	RES-CHIP	3.3K	5%	1/16W
R2230	1-218-990-81	SHORT CHIP				R3102	1-218-941-81	RES-CHIP	100	5%	1/16W
R2232	1-218-990-81	SHORT CHIP				R3103	1-218-941-81	RES-CHIP	100	5%	1/16W
R2234	1-208-935-11	METAL CHIP	100K	0.50%	1/16W	R3111	1-218-933-11	RES-CHIP	22	5%	1/16W
R2235	1-208-923-11	METAL CHIP	33K	0.50%	1/16W	R3113	1-218-933-11	RES-CHIP	22	5%	1/16W
R2236	1-208-695-11	METAL CHIP	3.3K	0.50%	1/16W	R3144	1-208-691-11	METAL CHIP	2.2K	0.50%	1/16W
R2237	1-208-695-11	METAL CHIP	3.3K	0.50%	1/16W	R3158	1-218-941-81	RES-CHIP	100	5%	1/16W
R2238	1-208-683-11	METAL CHIP	1K	0.50%	1/16W	R3162	1-218-973-11	RES-CHIP	47K	5%	1/16W
R2239	1-208-683-11	METAL CHIP	1K	0.50%	1/16W	R3165	1-218-965-11	RES-CHIP	10K	5%	1/16W
R2243	1-218-839-11	METAL CHIP	470	0.50%	1/10W	R3167	1-218-965-11	RES-CHIP	10K	5%	1/16W
R2244	1-218-839-11	METAL CHIP	470	0.50%	1/10W	R3168	1-218-965-11	RES-CHIP	10K	5%	1/16W
R2245	1-218-941-81	RES-CHIP	100	5%	1/16W	R3169	1-216-864-11	SHORT CHIP			
R2246	1-218-959-11	RES-CHIP	3.3K	5%	1/16W	R3170	1-400-794-21	FERRITE	0μH		
R2247	1-218-959-11	RES-CHIP	3.3K	5%	1/16W	R3180	1-218-965-11	RES-CHIP	10K	5%	1/16W
R2248	1-218-959-11	RES-CHIP	3.3K	5%	1/16W	R3181	1-218-965-11	RES-CHIP	10K	5%	1/16W
R2249	1-218-953-11	RES-CHIP	1K	5%	1/16W	R3186	1-218-990-81	SHORT CHIP			
R2259	1-208-695-11	METAL CHIP	3.3K	0.50%	1/16W	R3188	1-218-990-81	SHORT CHIP			
R2262	1-208-695-11	METAL CHIP	3.3K	0.50%	1/16W	R3190	1-208-886-81	METAL CHIP	910	0.50%	1/16W
R2268	1-218-941-81	RES-CHIP	100	5%	1/16W	R3191	1-218-969-11	RES-CHIP	22K	5%	1/16W
R2269	1-218-965-11	RES-CHIP	10K	5%	1/16W	R3193	1-218-965-11	RES-CHIP	10K	5%	1/16W
R2270	1-218-941-81	RES-CHIP	100	5%	1/16W	R3195	1-218-990-81	SHORT CHIP			
R2271	1-218-965-11	RES-CHIP	10K	5%	1/16W	R3196	1-218-965-11	RES-CHIP	10K	5%	1/16W
R2272	1-208-695-11	METAL CHIP	3.3K	0.50%	1/16W	R3198	1-218-990-81	SHORT CHIP			
R2273	1-208-695-11	METAL CHIP	3.3K	0.50%	1/16W	R3207	1-218-949-11	RES-CHIP	470	5%	1/16W
R2274	1-218-990-81	SHORT CHIP				R3208	1-218-990-81	SHORT CHIP			
R2275	1-218-990-81	SHORT CHIP				R3209	1-218-990-81	SHORT CHIP			
R2277	1-218-977-11	RES-CHIP	100K	5%	1/16W	R3210	1-218-949-11	RES-CHIP	470	5%	1/16W
R2279	1-218-977-11	RES-CHIP	100K	5%	1/16W	R3212	1-218-949-11	RES-CHIP	470	5%	1/16W
R2280	1-218-977-11	RES-CHIP	100K	5%	1/16W	R3218	1-218-961-11	RES-CHIP	4.7K	5%	1/16W
R2281	1-218-977-11	RES-CHIP	100K	5%	1/16W	R3223	1-218-945-11	RES-CHIP	220	5%	1/16W
R3001	1-216-864-11	SHORT CHIP				R3224	1-218-990-81	SHORT CHIP			
R3005	1-218-953-11	RES-CHIP	1K	5%	1/16W	R3226	1-218-945-11	RES-CHIP	220	5%	1/16W
R3010	1-218-990-81	SHORT CHIP				R3243	1-218-941-81	RES-CHIP	100	5%	1/16W
R3018	1-218-990-81	SHORT CHIP				R3246	1-218-965-11	RES-CHIP	10K	5%	1/16W
R3023	1-218-990-81	SHORT CHIP				R3247	1-218-990-81	SHORT CHIP			
R3031	1-208-931-11	METAL CHIP	68K	0.50%	1/16W	R3255	1-400-591-22	FERRITE	0μH		
R3034	1-208-703-11	METAL CHIP	6.8K	0.50%	1/16W	R3256	1-400-591-22	FERRITE	0μH		
R3037	1-208-711-11	METAL CHIP	15K	0.50%	1/16W	R3257	1-400-591-22	FERRITE	0μH		

BU1

REF. NO.	PART NO.	DESCRIPTION	VALUES			REF. NO.	PART NO.	DESCRIPTION	VALUES		
R3258	1-400-591-22	FERRITE	0μH			R4512	1-218-990-81	SHORT CHIP			
R3259	1-400-591-22	FERRITE	0μH			R4516	1-218-941-81	RES-CHIP	100	5%	1/16W
R3260	1-400-591-22	FERRITE	0μH			R4521	1-218-937-11	RES-CHIP	47	5%	1/16W
R3261	1-400-591-22	FERRITE	0μH			R4522	1-218-990-81	SHORT CHIP			
R3262	1-400-591-22	FERRITE	0μH			R4525	1-218-937-11	RES-CHIP	47	5%	1/16W
R3263	1-400-591-22	FERRITE	0μH			R4529	1-218-937-11	RES-CHIP	47	5%	1/16W
R3264	1-400-591-22	FERRITE	0μH			R4530	1-218-953-11	RES-CHIP	1K	5%	1/16W
R3265	1-400-591-22	FERRITE	0μH			R4532	1-218-941-81	RES-CHIP	100	5%	1/16W
R3266	1-216-864-11	SHORT CHIP				R4534	1-218-941-81	RES-CHIP	100	5%	1/16W
R3267	1-216-864-11	SHORT CHIP				R4536	1-218-933-11	RES-CHIP	22	5%	1/16W
R3270	1-218-941-81	RES-CHIP	100	5%	1/16W	R4537	1-218-941-81	RES-CHIP	100	5%	1/16W
R3271	1-218-977-11	RES-CHIP	100K	5%	1/16W	R4542	1-218-965-11	RES-CHIP	10K	5%	1/16W
R3274	1-218-977-11	RES-CHIP	100K	5%	1/16W	R4545	1-218-961-11	RES-CHIP	4.7K	5%	1/16W
R3290	1-218-990-81	SHORT CHIP				R4547	1-218-935-11	RES-CHIP	33	5%	1/16W
R3295	1-208-687-11	METAL CHIP	1.5K	0.50%	1/16W	R4548	1-218-941-81	RES-CHIP	100	5%	1/16W
R3515	1-218-990-81	SHORT CHIP				R4550	1-218-941-81	RES-CHIP	100	5%	1/16W
R3516	1-218-941-81	RES-CHIP	100	5%	1/16W	R4710	1-218-961-11	RES-CHIP	4.7K	5%	1/16W
R4002	1-218-977-11	RES-CHIP	100K	5%	1/16W	R4712	1-218-961-11	RES-CHIP	4.7K	5%	1/16W
R4006	1-218-977-11	RES-CHIP	100K	5%	1/16W	R4714	1-218-933-11	RES-CHIP	22	5%	1/16W
R4007	1-218-979-11	RES-CHIP	150K	5%	1/16W	R4715	1-218-933-11	RES-CHIP	22	5%	1/16W
R4008	1-218-965-11	RES-CHIP	10K	5%	1/16W	R4721	1-216-864-11	SHORT CHIP			
R4013	1-218-977-11	RES-CHIP	100K	5%	1/16W	R4722	1-216-864-11	SHORT CHIP			
R4042	1-218-977-11	RES-CHIP	100K	5%	1/16W	R4723	1-218-965-11	RES-CHIP	10K	5%	1/16W
R4043	1-218-971-11	RES-CHIP	33K	5%	1/16W	R4801	1-218-941-81	RES-CHIP	100	5%	1/16W
R4045	1-216-864-11	SHORT CHIP				R4802	1-218-949-11	RES-CHIP	470	5%	1/16W
R4047	1-218-957-11	RES-CHIP	2.2K	5%	1/16W	R4804	1-218-941-81	RES-CHIP	100	5%	1/16W
R4048	1-218-839-11	METAL CHIP	470	0.50%	1/10W	R4805	1-218-949-11	RES-CHIP	470	5%	1/16W
R4049	1-218-983-11	RES-CHIP	330K	5%	1/16W	R4808	1-218-941-81	RES-CHIP	100	5%	1/16W
R4050	1-218-971-11	RES-CHIP	33K	5%	1/16W	R4813	1-218-285-11	METAL CHIP	75	5%	1/10W
R4052	1-216-864-11	SHORT CHIP				R4814	1-218-981-11	RES-CHIP	220K	5%	1/16W
R4058	1-218-965-11	RES-CHIP	10K	5%	1/16W	R4900	1-400-794-21	FERRITE	0μH		
R4060	1-218-965-11	RES-CHIP	10K	5%	1/16W	R4903	1-208-683-11	METAL CHIP	1K	0.50%	1/16W
R4086	1-218-965-11	RES-CHIP	10K	5%	1/16W	R4904	1-208-683-11	METAL CHIP	1K	0.50%	1/16W
R4087	1-218-965-11	RES-CHIP	10K	5%	1/16W	R4905	1-218-990-81	SHORT CHIP			
R4088	1-218-971-11	RES-CHIP	33K	5%	1/16W	R4906	1-208-652-11	METAL CHIP	51	0.50%	1/16W
R4089	1-218-963-11	RES-CHIP	6.8K	5%	1/16W	R4907	1-218-990-81	SHORT CHIP			
R4090	1-218-965-11	RES-CHIP	10K	5%	1/16W	R4908	1-218-929-11	RES-CHIP	10	5%	1/16W
R4501	1-218-933-11	RES-CHIP	22	5%	1/16W	R4909	1-208-652-11	METAL CHIP	51	0.50%	1/16W
R4502	1-218-933-11	RES-CHIP	22	5%	1/16W	R4910	1-218-933-11	RES-CHIP	22	5%	1/16W
R4505	1-218-933-11	RES-CHIP	22	5%	1/16W	R4911	1-218-933-11	RES-CHIP	22	5%	1/16W
R4506	1-218-933-11	RES-CHIP	22	5%	1/16W	R4912	1-218-933-11	RES-CHIP	22	5%	1/16W
R4507	1-218-933-11	RES-CHIP	22	5%	1/16W	R4913	1-218-933-11	RES-CHIP	22	5%	1/16W
R4508	1-218-933-11	RES-CHIP	22	5%	1/16W	R4914	1-218-929-11	RES-CHIP	10	5%	1/16W
R4509	1-218-989-11	RES-CHIP	1M	5%	1/16W	R4915	1-218-929-11	RES-CHIP	10	5%	1/16W
R4510	1-218-990-81	SHORT CHIP				R4916	1-218-933-11	RES-CHIP	22	5%	1/16W

BU1

REF. NO.	PART NO.	DESCRIPTION	VALUES			REF. NO.	PART NO.	DESCRIPTION	VALUES		
R4917	1-218-933-11	RES-CHIP	22	5%	1/16W	R5563	1-218-929-11	RES-CHIP	10	5%	1/16W
R4918	1-218-933-11	RES-CHIP	22	5%	1/16W	R5564	1-218-929-11	RES-CHIP	10	5%	1/16W
R4919	1-218-933-11	RES-CHIP	22	5%	1/16W	R5565	1-218-929-11	RES-CHIP	10	5%	1/16W
R5000	1-216-864-11	SHORT CHIP				R5566	1-218-929-11	RES-CHIP	10	5%	1/16W
R5012	1-218-827-11	METAL CHIP	150	0.50%	1/10W	R5573	1-218-937-11	RES-CHIP	47	5%	1/16W
R5013	1-218-827-11	METAL CHIP	150	0.50%	1/10W	R5591	1-208-695-11	METAL CHIP	3.3K	0.50%	1/16W
R5014	1-218-827-11	METAL CHIP	150	0.50%	1/10W	R5592	1-208-695-11	METAL CHIP	3.3K	0.50%	1/16W
R5015	1-218-827-11	METAL CHIP	150	0.50%	1/10W	R5593	1-208-695-11	METAL CHIP	3.3K	0.50%	1/16W
R5016	1-218-953-11	RES-CHIP	1K	5%	1/16W	R5594	1-208-923-11	METAL CHIP	33K	0.50%	1/16W
R5017	1-218-827-11	METAL CHIP	150	0.50%	1/10W	R5622	1-218-965-11	RES-CHIP	10K	5%	1/16W
R5018	1-218-827-11	METAL CHIP	150	0.50%	1/10W	R5623	1-218-953-11	RES-CHIP	1K	5%	1/16W
R5019	1-218-977-11	RES-CHIP	100K	5%	1/16W	R5624	1-218-969-11	RES-CHIP	22K	5%	1/16W
R5021	1-216-801-11	METAL CHIP	22	5%	1/10W	R5625	1-218-969-11	RES-CHIP	22K	5%	1/16W
R5022	1-216-801-11	METAL CHIP	22	5%	1/10W	R5628	1-218-965-11	RES-CHIP	10K	5%	1/16W
R5023	1-216-801-11	METAL CHIP	22	5%	1/10W	R5629	1-218-970-11	RES-CHIP	27K	5%	1/16W
R5029	1-218-933-11	RES-CHIP	22	5%	1/16W	R5630	1-218-990-81	SHORT CHIP			
R5030	1-218-933-11	RES-CHIP	22	5%	1/16W	R5631	1-218-945-11	RES-CHIP	220	5%	1/16W
R5501	1-218-929-11	RES-CHIP	10	5%	1/16W	R5647	1-218-990-81	SHORT CHIP			
R5503	1-208-911-11	METAL CHIP	10K	0.50%	1/16W	R5649	1-218-990-81	SHORT CHIP			
R5504	1-208-683-11	METAL CHIP	1K	0.50%	1/16W	R5650	1-218-990-81	SHORT CHIP			
R5505	1-218-929-11	RES-CHIP	10	5%	1/16W	R5651	1-218-953-11	RES-CHIP	1K	5%	1/16W
R5511	1-208-911-11	METAL CHIP	10K	0.50%	1/16W	R5652	1-218-953-11	RES-CHIP	1K	5%	1/16W
R5512	1-208-683-11	METAL CHIP	1K	0.50%	1/16W	R5653	1-218-953-11	RES-CHIP	1K	5%	1/16W
R5519	1-218-961-11	RES-CHIP	4.7K	5%	1/16W	R7000	1-218-953-11	RES-CHIP	1K	5%	1/16W
R5523	1-218-977-11	RES-CHIP	100K	5%	1/16W	R7001	1-218-945-11	RES-CHIP	220	5%	1/16W
R5524	1-218-977-11	RES-CHIP	100K	5%	1/16W	R7005	1-208-703-11	METAL CHIP	6.8K	0.50%	1/16W
R5529	1-218-973-11	RES-CHIP	47K	5%	1/16W	R7009	1-208-931-11	METAL CHIP	68K	0.50%	1/16W
R5530	1-218-941-81	RES-CHIP	100	5%	1/16W	R7010	1-218-911-11	METAL CHIP	470K	0.50%	1/10W
R5531	1-218-977-11	RES-CHIP	100K	5%	1/16W	R7012	1-216-295-91	SHORT CHIP			
R5534	1-218-961-11	RES-CHIP	4.7K	5%	1/16W	R7013	1-218-990-81	SHORT CHIP			
R5538	1-218-973-11	RES-CHIP	47K	5%	1/16W	R7016	1-216-295-91	SHORT CHIP			
R5543	1-218-941-81	RES-CHIP	100	5%	1/16W	R7017	1-216-295-91	SHORT CHIP			
R5547	1-218-929-11	RES-CHIP	10	5%	1/16W	R7018	1-208-935-11	METAL CHIP	100K	0.50%	1/16W
R5548	1-218-929-11	RES-CHIP	10	5%	1/16W	R7019	1-218-965-11	RES-CHIP	10K	5%	1/16W
R5549	1-218-929-11	RES-CHIP	10	5%	1/16W	R7020	1-218-990-81	SHORT CHIP			
R5550	1-218-929-11	RES-CHIP	10	5%	1/16W	R7021	1-218-990-81	SHORT CHIP			
R5551	1-218-929-11	RES-CHIP	10	5%	1/16W	R7022	1-216-821-11	METAL CHIP	1K	5%	1/10W
R5552	1-218-929-11	RES-CHIP	10	5%	1/16W	R7023	1-216-818-11	METAL CHIP	560	5%	1/10W
R5553	1-218-929-11	RES-CHIP	10	5%	1/16W	R7024	1-218-941-81	RES-CHIP	100	5%	1/16W
R5556	1-218-929-11	RES-CHIP	10	5%	1/16W	R7025	1-208-936-11	METAL CHIP	110K	0.50%	1/16W
R5558	1-218-965-11	RES-CHIP	10K	5%	1/16W	R7026	1-208-935-11	METAL CHIP	100K	0.50%	1/16W
R5559	1-218-929-11	RES-CHIP	10	5%	1/16W	R7027	1-218-965-11	RES-CHIP	10K	5%	1/16W
R5560	1-218-929-11	RES-CHIP	10	5%	1/16W	R7028	1-208-956-81	METAL CHIP	750K	0.50%	1/16W
R5561	1-218-929-11	RES-CHIP	10	5%	1/16W	R7030	1-218-961-11	RES-CHIP	4.7K	5%	1/16W
R5562	1-218-929-11	RES-CHIP	10	5%	1/16W	R7032	1-218-990-81	SHORT CHIP			

BU1

REF. NO.	PART NO.	DESCRIPTION	VALUES			REF. NO.	PART NO.	DESCRIPTION	VALUES		
R7034	1-218-977-11	RES-CHIP	100K	5%	1/16W	R7084	1-216-864-11	SHORT CHIP			
R7035	1-208-695-11	METAL CHIP	3.3K	0.50%	1/16W	R7085	1-216-864-11	SHORT CHIP			
R7036	1-218-982-11	RES-CHIP	270K	5%	1/16W	R7087	1-216-864-11	SHORT CHIP			
R7037	1-208-687-11	METAL CHIP	1.5K	0.50%	1/16W	R7089	1-216-295-91	SHORT CHIP			
R7038	1-208-922-11	METAL CHIP	30K	0.50%	1/16W	R7090	1-216-295-91	SHORT CHIP			
R7039	1-208-715-11	METAL CHIP	22K	0.50%	1/16W	R7091	1-216-295-91	SHORT CHIP			
R7040	1-208-715-11	METAL CHIP	22K	0.50%	1/16W	R7092	1-208-721-11	METAL CHIP	39K	0.50%	1/16W
R7041	1-208-927-11	METAL CHIP	47K	0.50%	1/16W	R7093	1-208-927-11	METAL CHIP	47K	0.50%	1/16W
R7042	1-218-982-11	RES-CHIP	270K	5%	1/16W	R7094	1-218-958-11	RES-CHIP	2.7K	5%	1/16W
R7043	1-208-923-11	METAL CHIP	33K	0.50%	1/16W	R7095	1-208-675-11	METAL CHIP	470	0.50%	1/16W
R7044	1-208-929-81	METAL CHIP	56K	0.50%	1/16W	R7096	1-208-911-11	METAL CHIP	10K	0.50%	1/16W
R7045	1-208-923-11	METAL CHIP	33K	0.50%	1/16W	R7097	1-208-691-11	METAL CHIP	2.2K	0.50%	1/16W
R7046	1-208-923-11	METAL CHIP	33K	0.50%	1/16W	R7098	1-208-911-11	METAL CHIP	10K	0.50%	1/16W
R7047	1-208-691-11	METAL CHIP	2.2K	0.50%	1/16W	R7099	1-218-963-11	RES-CHIP	6.8K	5%	1/16W
R7048	1-218-941-81	RES-CHIP	100	5%	1/16W	R7100	1-220-915-91	METAL CHIP	0.033	2%	1/4W
R7049	1-208-691-11	METAL CHIP	2.2K	0.50%	1/16W	R7101	1-218-937-11	RES-CHIP	47	5%	1/16W
R7050	1-218-941-81	RES-CHIP	100	5%	1/16W	R7102	1-218-990-81	SHORT CHIP			
R7051	1-218-941-81	RES-CHIP	100	5%	1/16W	R7103	1-208-711-11	METAL CHIP	15K	0.50%	1/16W
R7052	1-208-691-11	METAL CHIP	2.2K	0.50%	1/16W	R7104	1-208-911-11	METAL CHIP	10K	0.50%	1/16W
R7053	1-218-958-11	RES-CHIP	2.7K	5%	1/16W	R7105	1-218-965-11	RES-CHIP	10K	5%	1/16W
R7054	1-208-691-11	METAL CHIP	2.2K	0.50%	1/16W	R7106	1-218-965-11	RES-CHIP	10K	5%	1/16W
R7055	1-208-935-11	METAL CHIP	100K	0.50%	1/16W	R7108	1-218-969-11	RES-CHIP	22K	5%	1/16W
R7056	1-208-935-11	METAL CHIP	100K	0.50%	1/16W	R7109	1-218-990-81	SHORT CHIP			
R7057	1-208-935-11	METAL CHIP	100K	0.50%	1/16W	R7110	1-218-937-11	RES-CHIP	47	5%	1/16W
R7058	1-208-935-11	METAL CHIP	100K	0.50%	1/16W	R7183	1-218-990-81	SHORT CHIP			
R7059	1-218-937-11	RES-CHIP	47	5%	1/16W	R7307	1-218-965-11	RES-CHIP	10K	5%	1/16W
R7060	1-218-937-11	RES-CHIP	47	5%	1/16W	R7308	1-218-941-81	RES-CHIP	100	5%	1/16W
R7061	1-218-937-11	RES-CHIP	47	5%	1/16W	R7309	1-218-990-81	SHORT CHIP			
R7062	1-218-937-11	RES-CHIP	47	5%	1/16W	R7316	1-218-990-81	SHORT CHIP			
R7063	1-216-864-11	SHORT CHIP				R7317	1-216-864-11	SHORT CHIP			
R7064	1-216-864-11	SHORT CHIP				R7318	1-216-864-11	SHORT CHIP			
R7065	1-208-911-11	METAL CHIP	10K	0.50%	1/16W	R7319	1-218-990-81	SHORT CHIP			
R7066	1-208-709-11	METAL CHIP	12K	0.50%	1/16W	R7320	1-218-941-81	RES-CHIP	100	5%	1/16W
R7067	1-208-911-11	METAL CHIP	10K	0.50%	1/16W	R7321	1-218-933-11	RES-CHIP	22	5%	1/16W
R7068	1-208-911-11	METAL CHIP	10K	0.50%	1/16W	R7327	1-218-977-11	RES-CHIP	100K	5%	1/16W
R7069	1-216-295-91	SHORT CHIP				R7328	1-218-959-11	RES-CHIP	3.3K	5%	1/16W
R7070	1-216-295-91	SHORT CHIP				R7329	1-216-835-11	METAL CHIP	15K	5%	1/10W
R7071	1-216-791-11	METAL CHIP	3.3	5%	1/10W	R7330	1-218-959-11	RES-CHIP	3.3K	5%	1/16W
R7072	1-216-791-11	METAL CHIP	3.3	5%	1/10W	R7331	1-216-835-11	METAL CHIP	15K	5%	1/10W
R7073	1-216-791-11	METAL CHIP	3.3	5%	1/10W	R7332	1-216-835-11	METAL CHIP	15K	5%	1/10W
R7074	1-216-791-11	METAL CHIP	3.3	5%	1/10W	R7333	1-216-835-11	METAL CHIP	15K	5%	1/10W
R7079	1-216-295-91	SHORT CHIP				R7400	1-208-911-11	METAL CHIP	10K	0.50%	1/16W
R7080	1-216-295-91	SHORT CHIP				R7401	1-208-855-81	METAL CHIP	47	0.50%	1/16W
R7081	1-216-295-91	SHORT CHIP				R7402	1-208-683-11	METAL CHIP	1K	0.50%	1/16W
R7082	1-216-295-91	SHORT CHIP				R7403	1-208-683-11	METAL CHIP	1K	0.50%	1/16W

BU1

REF. NO.	PART NO.	DESCRIPTION	VALUES			REF. NO.	PART NO.	DESCRIPTION	VALUES		
R7404	1-208-683-11	METAL CHIP	1K	0.50%	1/16W	R7717	1-218-935-11	RES-CHIP	33	5%	1/16W
R7405	1-208-683-11	METAL CHIP	1K	0.50%	1/16W	R7718	1-218-953-11	RES-CHIP	1K	5%	1/16W
R7406	1-208-683-11	METAL CHIP	1K	0.50%	1/16W	R7720	1-218-941-81	RES-CHIP	100	5%	1/16W
R7407	1-208-683-11	METAL CHIP	1K	0.50%	1/16W	R7800	1-218-953-11	RES-CHIP	1K	5%	1/16W
R7408	1-208-683-11	METAL CHIP	1K	0.50%	1/16W	R7803	1-218-959-11	RES-CHIP	3.3K	5%	1/16W
R7501	1-218-957-11	RES-CHIP	2.2K	5%	1/16W	R7808	1-218-949-11	RES-CHIP	470	5%	1/16W
R7506	1-218-965-11	RES-CHIP	10K	5%	1/16W	R7814	1-218-941-81	RES-CHIP	100	5%	1/16W
R7507	1-218-965-11	RES-CHIP	10K	5%	1/16W	R7819	1-218-941-81	RES-CHIP	100	5%	1/16W
R7508	1-218-977-11	RES-CHIP	100K	5%	1/16W	R7821	1-218-969-11	RES-CHIP	22K	5%	1/16W
R7516	1-218-965-11	RES-CHIP	10K	5%	1/16W	R7822	1-218-969-11	RES-CHIP	22K	5%	1/16W
R7517	1-218-965-11	RES-CHIP	10K	5%	1/16W	R7829	1-218-961-11	RES-CHIP	4.7K	5%	1/16W
R7521	1-218-965-11	RES-CHIP	10K	5%	1/16W	R7831	1-218-989-11	RES-CHIP	1M	5%	1/16W
R7526	1-218-965-11	RES-CHIP	10K	5%	1/16W	R7834	1-218-957-11	RES-CHIP	2.2K	5%	1/16W
R7528	1-218-953-11	RES-CHIP	1K	5%	1/16W	R7836	1-218-990-81	SHORT CHIP			
R7529	1-218-985-11	RES-CHIP	470K	5%	1/16W	R7838	1-218-958-11	RES-CHIP	2.7K	5%	1/16W
R7532	1-218-990-81	SHORT CHIP				R7839	1-208-697-11	METAL CHIP	3.9K	0.50%	1/16W
R7533	1-218-446-11	METAL CHIP	1	5%	1/10W	R7840	1-218-953-11	RES-CHIP	1K	5%	1/16W
R7535	1-218-990-81	SHORT CHIP				R7842	1-218-953-11	RES-CHIP	1K	5%	1/16W
R7536	1-218-965-11	RES-CHIP	10K	5%	1/16W	R7843	1-208-663-11	METAL CHIP	150	0.50%	1/16W
R7538	1-218-990-81	SHORT CHIP				R7844	1-208-893-11	METAL CHIP	1.8K	0.50%	1/16W
R7600	1-218-933-11	RES-CHIP	22	5%	1/16W	R7845	1-218-965-11	RES-CHIP	10K	5%	1/16W
R7601	1-218-933-11	RES-CHIP	22	5%	1/16W	R7847	1-218-941-81	RES-CHIP	100	5%	1/16W
R7602	1-218-933-11	RES-CHIP	22	5%	1/16W	R7848	1-218-989-11	RES-CHIP	1M	5%	1/16W
R7603	1-218-933-11	RES-CHIP	22	5%	1/16W	R7849	1-208-713-11	METAL CHIP	18K	0.50%	1/16W
R7604	1-218-933-11	RES-CHIP	22	5%	1/16W	R7851	1-218-959-11	RES-CHIP	3.3K	5%	1/16W
R7605	1-218-933-11	RES-CHIP	22	5%	1/16W	R7852	1-218-978-11	RES-CHIP	120K	5%	1/16W
R7607	1-218-933-11	RES-CHIP	22	5%	1/16W	R7853	1-218-965-11	RES-CHIP	10K	5%	1/16W
R7608	1-218-973-11	RES-CHIP	47K	5%	1/16W	R7854	1-218-990-81	SHORT CHIP			
R7609	1-218-965-11	RES-CHIP	10K	5%	1/16W	R7855	1-218-990-81	SHORT CHIP			
R7610	1-218-953-11	RES-CHIP	1K	5%	1/16W	R7857	1-218-937-11	RES-CHIP	47	5%	1/16W
R7611	1-218-933-11	RES-CHIP	22	5%	1/16W	R7860	1-218-965-11	RES-CHIP	10K	5%	1/16W
R7614	1-218-990-81	SHORT CHIP				R7861	1-218-961-11	RES-CHIP	4.7K	5%	1/16W
R7703	1-218-941-81	RES-CHIP	100	5%	1/16W	R7862	1-218-959-11	RES-CHIP	3.3K	5%	1/16W
R7704	1-218-941-81	RES-CHIP	100	5%	1/16W	R7863	1-218-979-11	RES-CHIP	150K	5%	1/16W
R7705	1-218-941-81	RES-CHIP	100	5%	1/16W	R7864	1-218-989-11	RES-CHIP	1M	5%	1/16W
R7706	1-218-935-11	RES-CHIP	33	5%	1/16W	R7865	1-218-957-11	RES-CHIP	2.2K	5%	1/16W
R7707	1-218-941-81	RES-CHIP	100	5%	1/16W	R7869	1-218-941-81	RES-CHIP	100	5%	1/16W
R7708	1-218-941-81	RES-CHIP	100	5%	1/16W	R7874	1-218-990-81	SHORT CHIP			
R7709	1-218-941-81	RES-CHIP	100	5%	1/16W	R7875	1-218-990-81	SHORT CHIP			
R7710	1-218-935-11	RES-CHIP	33	5%	1/16W	R7876	1-218-990-81	SHORT CHIP			
R7711	1-218-965-11	RES-CHIP	10K	5%	1/16W	R7885	1-216-295-91	SHORT CHIP			
R7712	1-218-935-11	RES-CHIP	33	5%	1/16W	R7886	1-216-295-91	SHORT CHIP			
R7714	1-218-953-11	RES-CHIP	1K	5%	1/16W	R7964	1-218-969-11	RES-CHIP	22K	5%	1/16W
R7715	1-218-953-11	RES-CHIP	1K	5%	1/16W	R7965	1-208-928-11	METAL CHIP	51K	0.50%	1/16W
R7716	1-218-935-11	RES-CHIP	33	5%	1/16W	R7967	1-218-941-81	RES-CHIP	100	5%	1/16W

BU1

REF. NO.	PART NO.	DESCRIPTION	VALUES			REF. NO.	PART NO.	DESCRIPTION	VALUES		
R7969	1-208-928-11	METAL CHIP	51K	0.50%	1/16W	RB4503	1-234-370-21	RES, NETWORK 22	(1005X4)		
R7970	1-218-969-11	RES-CHIP	22K	5%	1/16W	RB4504	1-234-370-21	RES, NETWORK 22	(1005X4)		
R7971	1-218-941-81	RES-CHIP	100	5%	1/16W	RB4505	1-234-370-21	RES, NETWORK 22	(1005X4)		
R7972	1-218-959-11	RES-CHIP	3.3K	5%	1/16W	RB4510	1-234-372-11	RES, NETWORK 100	(1005X4)		
R7973	1-218-959-11	RES-CHIP	3.3K	5%	1/16W	RB4511	1-234-106-81	RES, NETWORK 0			
R7974	1-218-941-81	RES-CHIP	100	5%	1/16W	RB4512	1-239-698-11	RESISTOR, NETWORK 10K			
R7975	1-218-941-81	RES-CHIP	100	5%	1/16W	RB4701	1-234-372-11	RES, NETWORK 100	(1005X4)		
R7978	1-218-989-11	RES-CHIP	1M	5%	1/16W	RB4702	1-234-372-11	RES, NETWORK 100	(1005X4)		
R7979	1-218-990-81	SHORT CHIP				RB4703	1-234-372-11	RES, NETWORK 100	(1005X4)		
R7980	1-208-893-11	METAL CHIP	1.8K	0.50%	1/16W	RB4704	1-239-698-11	RESISTOR, NETWORK 10K			
R7990	1-218-965-11	RES-CHIP	10K	5%	1/16W	RB4800	1-239-674-81	RESISTOR, NETWORK 100			
RESISTOR BRIDGE						RB4900	1-234-369-21	RES, NETWORK 10	(1005X4)		
RB2001	1-234-381-21	RES, NETWORK 100K	(1005X4)			RB4901	1-234-369-21	RES, NETWORK 10	(1005X4)		
RB2003	1-239-698-11	RESISTOR, NETWORK 10K				RB4902	1-234-369-21	RES, NETWORK 10	(1005X4)		
RB2004	1-239-674-81	RESISTOR, NETWORK 100				RB4903	1-234-369-21	RES, NETWORK 10	(1005X4)		
RB2006	1-234-378-21	RES, NETWORK 10K	(1005X4)			RB4904	1-234-370-21	RES, NETWORK 22	(1005X4)		
RB2007	1-234-378-21	RES, NETWORK 10K	(1005X4)			RB4905	1-234-370-21	RES, NETWORK 22	(1005X4)		
RB2008	1-239-674-81	RESISTOR, NETWORK 100				RB4906	1-234-370-21	RES, NETWORK 22	(1005X4)		
RB2009	1-239-674-81	RESISTOR, NETWORK 100				RB4907	1-234-370-21	RES, NETWORK 22	(1005X4)		
RB2010	1-239-698-11	RESISTOR, NETWORK 10K				RB4908	1-234-370-21	RES, NETWORK 22	(1005X4)		
RB2011	1-239-698-11	RESISTOR, NETWORK 10K				RB4909	1-234-370-21	RES, NETWORK 22	(1005X4)		
RB2012	1-239-698-11	RESISTOR, NETWORK 10K				RB4910	1-234-370-21	RES, NETWORK 22	(1005X4)		
RB3004	1-234-372-11	RES, NETWORK 100	(1005X4)			RB4911	1-234-370-21	RES, NETWORK 22	(1005X4)		
RB3005	1-234-372-11	RES, NETWORK 100	(1005X4)			RB5001	1-239-698-11	RESISTOR, NETWORK 10K			
RB3006	1-234-372-11	RES, NETWORK 100	(1005X4)			RB5002	1-239-670-81	RESISTOR, NETWORK 47			
RB3007	1-234-378-21	RES, NETWORK 10K	(1005X4)			RB5504	1-239-674-81	RESISTOR, NETWORK 100			
RB3008	1-234-378-21	RES, NETWORK 10K	(1005X4)			RB5505	1-239-674-81	RESISTOR, NETWORK 100			
RB3010	1-234-372-11	RES, NETWORK 100	(1005X4)			RB5507	1-239-670-81	RESISTOR, NETWORK 47			
RB3011	1-234-372-11	RES, NETWORK 100	(1005X4)			RB5508	1-239-706-81	RESISTOR, NETWORK 47K			
RB3014	1-239-698-11	RESISTOR, NETWORK 10K				RB5509	1-239-698-11	RESISTOR, NETWORK 10K			
RB3015	1-239-670-81	RESISTOR, NETWORK 47				RB5510	1-239-706-81	RESISTOR, NETWORK 47K			
RB3016	1-239-698-11	RESISTOR, NETWORK 10K				RB5511	1-239-706-81	RESISTOR, NETWORK 47K			
RB3017	1-239-674-81	RESISTOR, NETWORK 100				RB7300	1-239-674-81	RESISTOR, NETWORK 100			
RB3018	1-239-698-11	RESISTOR, NETWORK 10K				RB7301	1-234-106-81	RES, NETWORK 0			
RB3019	1-239-698-11	RESISTOR, NETWORK 10K				RB7302	1-234-370-21	RES, NETWORK 22	(1005X4)		
RB3020	1-239-674-81	RESISTOR, NETWORK 100				RB7500	1-239-674-81	RESISTOR, NETWORK 100			
RB3021	1-239-674-81	RESISTOR, NETWORK 100				RB7600	1-234-370-21	RES, NETWORK 22	(1005X4)		
RB3022	1-239-698-11	RESISTOR, NETWORK 10K				RB7601	1-234-370-21	RES, NETWORK 22	(1005X4)		
RB3024	1-239-698-11	RESISTOR, NETWORK 10K				RB7602	1-234-370-21	RES, NETWORK 22	(1005X4)		
RB4500	1-234-795-21	RES, NETWORK 0X4	(2010)			RB7603	1-234-370-21	RES, NETWORK 22	(1005X4)		
RB4501	1-234-795-21	RES, NETWORK 0X4	(2010)			RB7604	1-234-370-21	RES, NETWORK 22	(1005X4)		
RB4502	1-234-370-21	RES, NETWORK 22	(1005X4)			RB7606	1-234-370-21	RES, NETWORK 22	(1005X4)		
						RB7607	1-234-378-21	RES, NETWORK 10K	(1005X4)		
						RB7608	1-234-370-21	RES, NETWORK 22	(1005X4)		
						RB7609	1-234-370-21	RES, NETWORK 22	(1005X4)		

D1

REF. NO.	PART NO.	DESCRIPTION	VALUES			REF. NO.	PART NO.	DESCRIPTION	VALUES		
C6710	1-162-967-11	CERAMIC CHIP (KDL-40S3000 ONLY)	0.0033 μ F	10%	50V	C6753	1-107-906-11	ELECT	10 μ F	20%	50V
C6710	1-162-968-11	CERAMIC CHIP (KDL-46S3000 ONLY)	0.0047 μ F	10%	50V	C6754	1-107-826-11	CERAMIC CHIP	0.1 μ F	10%	16V
C6711	1-104-512-11	CERAMIC (KDL-40S3000 ONLY)	22pF	5%	6.3KV	C6755	1-162-964-11	CERAMIC CHIP	0.001 μ F	10%	50V
C6712	1-162-979-11	CERAMIC CHIP (KDL-40S3000 ONLY)	0.0027 μ F	10%	50V	C6756	1-100-566-91	CERAMIC CHIP	0.1 μ F	10%	25V
C6712	1-162-968-11	CERAMIC CHIP (KDL-46S3000 ONLY)	0.0047 μ F	10%	50V	C6757	1-100-566-91	CERAMIC CHIP	0.1 μ F	10%	25V
C6715	1-125-891-11	CERAMIC CHIP	0.47 μ F	10%	10V	C6758	1-100-566-91	CERAMIC CHIP (KDL-40S3000 ONLY)	0.1 μ F	10%	25V
C6716	1-162-970-11	CERAMIC CHIP	0.01 μ F	5%	25V	C6759	1-107-882-91	ELECT	100 μ F	20%	16V
C6717	1-164-217-11	CERAMIC CHIP	150pF	5%	50V	C6785	1-100-566-91	CERAMIC CHIP	0.1 μ F	10%	25V
C6718	1-162-970-11	CERAMIC CHIP	0.01 μ F	10%	25V	C6789	1-107-888-11	ELECT	47 μ F	20%	25V
C6719	1-164-315-11	CERAMIC CHIP	470pF	5%	50V	C6794	1-100-566-91	CERAMIC CHIP	0.1 μ F	10%	25V
C6720	1-162-964-11	CERAMIC CHIP	0.001 μ F	10%	50V	CONNECTOR					
C6721	1-165-908-11	CERAMIC CHIP	1 μ F	10%	10V	* CN6600	1-793-660-11	PIN, CONNECTOR (PC BOARD)			
C6722	1-165-908-11	CERAMIC CHIP	1 μ F	10%	10V	* CN6704	1-793-235-11	PIN, CONNECTOR (PC BOARD)	13P		
C6723	1-165-908-11	CERAMIC CHIP	1 μ F	10%	10V	* CN6707	1-778-853-11	PIN, CONNECTOR (PC BOARD)	8P		
C6724	1-127-804-91	CERAMIC CHIP	100pF	1%	50V	DIODE					
C6725	1-107-826-11	CERAMIC CHIP	0.1 μ F	10%	16V	D6608	8-719-041-97	DIODE	MA113-(TX)		
C6726	1-127-573-11	CERAMIC CHIP	1 μ F	10%	16V	D6609	8-719-041-97	DIODE	MA113-(TX)		
C6727	1-165-908-11	CERAMIC CHIP	1 μ F	10%	10V	D6623	8-719-083-57	DIODE	UDZSTE-173.6B		
C6728	1-162-970-11	CERAMIC CHIP	0.01 μ F	10%	25V	D6624	8-719-083-57	DIODE	UDZSTE-173.6B		
C6729	1-107-882-91	ELECT	100 μ F	20%	16V	D6625	6-500-137-01	DIODE	BAT54HT1		
C6730	1-162-970-11	CERAMIC CHIP	0.01 μ F	10%	25V	D6700	8-719-420-90	DIODE	MA8051-M		
C6731	1-162-964-11	CERAMIC CHIP	0.001 μ F	10%	50V	D6701	8-719-420-90	DIODE	MA8051-M		
C6732	1-100-591-91	CERAMIC CHIP	1 μ F	10%	25V	D6702	8-719-404-50	DIODE	MA111-TX		
C6733	1-165-176-11	CERAMIC CHIP	0.047 μ F	10%	16V	D6703	8-719-404-50	DIODE	MA111-TX		
C6738	1-165-908-11	CERAMIC CHIP	1 μ F	10%	10V	D6704	8-719-800-76	DIODE	1SS226		
C6739	1-162-970-11	CERAMIC CHIP	0.01 μ F	10%	25V	D6705	8-719-800-76	DIODE	1SS226		
C6740	1-107-882-91	ELECT	100 μ F	20%	16V	D6708	6-500-335-01	DIODE	MC2838-T112-1		
C6741	1-165-908-11	CERAMIC CHIP	1 μ F	10%	10V	D6709	8-719-017-58	DIODE	MA8068		
C6742	1-100-566-91	CERAMIC CHIP	0.1 μ F	10%	25V	D6710	8-719-017-58	DIODE	MA8068		
C6743	1-100-566-91	CERAMIC CHIP	0.1 μ F	10%	25V	D6714	8-719-422-12	DIODE	MA8039		
C6744	1-100-566-91	CERAMIC CHIP	0.1 μ F	10%	25V	D6715	8-719-422-12	DIODE	MA8039		
C6745	1-107-877-11	ELECT	1000 μ F	20%	10V	D6717	8-719-404-50	DIODE	MA111-TX		
C6746	1-100-566-91	CERAMIC CHIP	0.1 μ F	10%	25V	D6718	8-719-404-50	DIODE	MA111-TX		
C6747	1-100-566-91	CERAMIC CHIP	0.1 μ F	10%	25V	GROUND TERMINAL					
C6748	1-165-908-11	CERAMIC CHIP	1 μ F	10%	10V	ET6700	1-537-770-21	TERMINAL BOARD, GROUND			
C6749	1-100-566-91	CERAMIC CHIP	0.1 μ F	10%	25V	ET6701	1-537-770-21	TERMINAL BOARD, GROUND			
C6750	1-162-970-11	CERAMIC CHIP	0.01 μ F	10%	25V	FERRITE BEAD					
C6751	1-162-927-11	CERAMIC CHIP (KDL-40S3000 ONLY)	100pF	5%	50V	FB6604	1-412-911-11	FERRITE	0 μ H		
C6752	1-162-927-11	CERAMIC CHIP (KDL-40S3000 ONLY)	100pF	5%	50V	FB6605	1-412-911-11	FERRITE	0 μ H		
						FB6606	1-412-911-11	FERRITE	0 μ H		

NOTE: The components identified by shading and \triangle mark are critical for safety. Replace only with part number specified.

NOTE: Les composants identifiés par un trame et une marque \triangle sont critiques pour la sécurité. Ne les remplacer que par une pièce portant le numéro spécifié.

D1

REF. NO.	PART NO.	DESCRIPTION	VALUES	REF. NO.	PART NO.	DESCRIPTION	VALUES
FB6607	1-412-911-11	FERRITE	0 μ H	R6612	1-249-403-11	CARBON	68 5% 1/4W
FB6609	1-481-256-11	FERRITE	0 μ H	R6613	1-249-403-11	CARBON	68 5% 1/4W
FB6610	1-410-396-41	FERRITE	0.45 μ H				
	IC						
	IC6702	6-708-762-01	IC	PQ200WNA1ZPH			
*	IC6703	8-759-575-27	IC	BA10339F-E2			
	IC6704	6-709-368-01	IC	MM1431ATT (CN)			
	CHIP CONDUCTOR						
JR6700	1-216-296-11	SHORT CHIP		\triangle R6700	1-216-793-11	METAL CHIP	4.7 5% 1/10W
JR6701	1-216-296-11	SHORT CHIP		R6701	1-216-793-11	METAL CHIP	4.7 5% 1/10W
JR6702	1-216-296-11	SHORT CHIP		R6702	1-216-793-11	METAL CHIP	4.7 5% 1/10W
JR6703	1-216-296-11	SHORT CHIP					
JR6704	1-216-296-11	SHORT CHIP					
JR6705	1-216-296-11	SHORT CHIP		R6703	1-216-793-11	METAL CHIP	4.7 5% 1/10W
JR6706	1-216-296-11	SHORT CHIP		R6704	1-216-793-11	METAL CHIP	4.7 5% 1/10W
JR6707	1-216-296-11	SHORT CHIP		R6705	1-216-833-11	METAL CHIP	10K 5% 1/10W
JR6709	1-216-296-11	SHORT CHIP		R6706	1-216-833-11	METAL CHIP	10K 5% 1/10W
JR6714	1-216-296-11	SHORT CHIP		R6707	1-216-833-11	METAL CHIP	10K 5% 1/10W
JR6717	1-216-864-11	SHORT CHIP					
JR6718	1-216-864-11	SHORT CHIP		R6708	1-216-833-11	METAL CHIP	10K 5% 1/10W
JR6719	1-216-296-11	SHORT CHIP		R6710	1-243-831-71	METAL OXIDE	12 5% 1W
JR6721	1-216-296-11	SHORT CHIP		R6711	1-243-831-71	METAL OXIDE	12 5% 1W
JR6724	1-216-296-11	SHORT CHIP		R6712	1-243-831-71	METAL OXIDE	12 5% 1W
JR6725	1-216-864-11	SHORT CHIP		R6713	1-243-831-71	METAL OXIDE	12 5% 1W
JR6726	1-216-296-11	SHORT CHIP					
JR6727	1-216-864-11	SHORT CHIP		R6714	1-216-829-11	METAL CHIP	4.7K 5% 1/10W (KDL-40S3000 ONLY)
	COIL			R6714	1-218-853-11	METAL CHIP	1.8K 0.50% 1/10W (KDL-46S3000 ONLY)
L6600	1-406-977-21	INDUCTOR	100 μ H	R6715	1-216-837-11	METAL CHIP	22K 5% 1/10W (KDL-40S3000 ONLY)
	TRANSISTOR			R6715	1-218-855-11	METAL CHIP	2.2K 0.50% 1/10W (KDL-46S3000 ONLY)
Q6604	8-729-804-41	TRANSISTOR	2SB1122-S	R6716	1-218-855-11	METAL CHIP	2.2K 0.50% 1/10W
Q6605	8-729-804-41	TRANSISTOR	2SB1122-S	R6721	1-216-817-11	METAL CHIP	470 5% 1/10W
Q6704	8-729-028-27	TRANSISTOR	2SK2009(TE85L)	R6722	1-218-897-11	METAL CHIP	120K 0.50% 1/10W
Q6705	8-729-620-07	TRANSISTOR	2SC3052EF-T1-LEF				
Q6711	8-729-620-07	TRANSISTOR	2SC3052EF-T1-LEF	R6723	1-218-871-11	METAL CHIP	10K 0.50% 1/10W
Q6712	8-729-600-22	TRANSISTOR	2SA1235-F	R6724	1-216-864-11	SHORT CHIP	
Q6714	8-729-600-22	TRANSISTOR	2SA1235-F	R6725	1-218-891-11	METAL CHIP	68K 0.50% 1/10W
	RESISTOR			R6727	1-216-841-11	METAL CHIP	47K 5% 1/10W
R6609	1-216-857-11	METAL CHIP	1M 5% 1/10W	R6729	1-216-829-11	METAL CHIP	4.7K 5% 1/10W
R6610	1-216-057-00	RES-CHIP	2.2K 5% 1/10W				
R6611	1-216-057-00	RES-CHIP	2.2K 5% 1/10W	R6730	1-216-829-11	METAL CHIP	4.7K 5% 1/10W
				R6731	1-216-837-11	METAL CHIP	22K 5% 1/10W
				R6732	1-218-893-11	METAL CHIP	82K 0.50% 1/10W (KDL-40S3000 ONLY)
				R6732	1-218-889-11	METAL CHIP	56K 0.50% 1/10W (KDL-46S3000 ONLY)
				R6733	1-218-863-11	METAL CHIP	4.7K 0.50% 1/10W
				R6734	1-216-833-11	METAL CHIP	10K 5% 1/10W

NOTE: The components identified by shading and \triangle mark are critical for safety. Replace only with part number specified.

NOTE: Les composants identifiés par un trame et une marque \triangle sont critiques pour la sécurité. Ne les remplacer que par une pièce portant le numéro spécifié.

D2 **G1D** **G1H**

REF. NO.	PART NO.	DESCRIPTION	VALUES	REF. NO.	PART NO.	DESCRIPTION	VALUES
<u>DIODE</u>				R6914	1-216-793-11	METAL CHIP	4.7 5% 1/10W
D6902	8-719-041-97	DIODE	MA113-(TX)	R6917	1-216-833-11	METAL CHIP	10K 5% 1/10W
D6903	8-719-041-97	DIODE	MA113-(TX)	R6918	1-216-833-11	METAL CHIP	10K 5% 1/10W
D6904	8-719-083-57	DIODE	UDZSTE-173.6B	R6919	1-216-857-11	METAL CHIP	1M 5% 1/10W
D6905	8-719-083-57	DIODE	UDZSTE-173.6B	\triangle R6950	1-216-793-11	METAL CHIP	4.7 5% 1/10W
D6950	8-719-420-90	DIODE	MA8051-M	R6951	1-216-793-11	METAL CHIP	4.7 5% 1/10W
D6951	8-719-420-90	DIODE	MA8051-M	R6952	1-216-793-11	METAL CHIP	4.7 5% 1/10W
D6952	8-719-404-50	DIODE	MA111-TX	R6953	1-216-793-11	METAL CHIP	4.7 5% 1/10W
D6953	8-719-404-50	DIODE	MA111-TX	R6954	1-216-793-11	METAL CHIP	4.7 5% 1/10W
D6954	8-719-800-76	DIODE	1SS226	R6955	1-216-833-11	METAL CHIP	10K 5% 1/10W
D6955	8-719-800-76	DIODE	1SS226	R6956	1-216-833-11	METAL CHIP	10K 5% 1/10W
<u>GROUND TERMINAL</u>				R6957	1-216-833-11	METAL CHIP	10K 5% 1/10W
ET6950	1-537-770-21	TERMINAL BOARD, GROUND		R6958	1-216-833-11	METAL CHIP	10K 5% 1/10W
ET6951	1-537-770-21	TERMINAL BOARD, GROUND		R6960	1-243-831-71	METAL OXIDE	12 5% 1W
<u>FERRITE BEAD</u>				R6961	1-243-831-71	METAL OXIDE	12 5% 1W
FB6901	1-481-256-11	FERRITE	0 μ H	R6962	1-243-831-71	METAL OXIDE	12 5% 1W
FB6904	1-412-911-11	FERRITE	0 μ H	R6963	1-243-831-71	METAL OXIDE	12 5% 1W
FB6905	1-412-911-11	FERRITE	0 μ H	R6965	1-216-864-11	SHORT CHIP	
FB6906	1-412-911-11	FERRITE	0 μ H	R6966	1-216-864-11	SHORT CHIP	
FB6907	1-412-911-11	FERRITE	0 μ H	<u>TRANSFORMER</u>			
<u>CHIP CONDUCTOR</u>				T6950	1-445-237-11	TRANSFORMER, DRIVE	
JR6900	1-216-296-11	SHORT CHIP		G1D			
JR6901	1-216-296-11	SHORT CHIP		1-474-056-11 G1D BOARD, COMPLETE (POWER SUPPLY) (KDL-26S3000 ONLY)			
JR6902	1-216-296-11	SHORT CHIP		This board is manufactured by a 3rd party. Component level repair information is not available.			
JR6903	1-216-296-11	SHORT CHIP		G1H			
<u>COIL</u>				1-474-052-11 G1H BOARD, COMPLETE (POWER SUPPLY) (KDL-32S3000 ONLY)			
L6900	1-406-977-21	INDUCTOR	100 μ H	This board is manufactured by a 3rd party. Component level repair information is not available.			
<u>TRANSISTOR</u>							
Q6902	8-729-804-41	TRANSISTOR	2SB1122-S				
Q6903	8-729-804-41	TRANSISTOR	2SB1122-S				
<u>RESISTOR</u>							
R6903	1-216-057-00	RES-CHIP	2.2K 5% 1/10W				
R6904	1-216-057-00	RES-CHIP	2.2K 5% 1/10W				
R6907	1-216-057-00	RES-CHIP	2.2K 5% 1/10W				
R6908	1-216-057-00	RES-CHIP	2.2K 5% 1/10W				
R6911	1-249-403-11	CARBON	68 5% 1/4W				
R6912	1-249-403-11	CARBON	68 5% 1/4W				
R6913	1-216-793-11	METAL CHIP	4.7 5% 1/10W				

NOTE: The components identified by shading and \triangle mark are critical for safety. Replace only with part number specified.

NOTE: Les composants identifiés par un trame et une marque \triangle sont critiques pour la sécurité. Ne les remplacer que par une pièce portant le numéro spécifié.



REF. NO.	PART NO.	DESCRIPTION	VALUES			REF. NO.	PART NO.	DESCRIPTION	VALUES		
						C6250	1-128-949-31	ELECT	470 μ F	20%	16V
A-1308-804-A G3 BOARD, COMPLETE(POWER SUPPLY) (KDL-40S3000/46S3000 ONLY)						C6251	1-107-826-11	CERAMIC CHIP	0.1 μ F	10%	16V
	4-382-854-11	SCREW (M3X10), P, SW (+)				C6300	1-165-908-11	CERAMIC CHIP	1 μ F	10%	10V
CAPACITOR						C6301	1-107-826-11	CERAMIC CHIP	0.1 μ F	10%	16V
C6000	1-113-889-11	CERAMIC	0.001 μ F	20%	250V	C6302	1-162-964-11	CERAMIC CHIP	0.001 μ F	10%	50V
C6002	1-165-530-11	MYLAR	0.47 μ F	10	275V	C6304	1-100-566-91	CERAMIC CHIP	0.1 μ F	10%	25V
C6005	1-113-889-11	CERAMIC	0.001 μ F	20%	250V	C6305	1-162-964-11	CERAMIC CHIP	0.001 μ F	10%	50V
C6007	1-119-892-51	CERAMIC	470pF	10%	250V	C6306	1-125-891-11	CERAMIC CHIP	0.47 μ F	10%	10V
C6011	1-119-892-51	CERAMIC	470pF	10%	250V	C6307	1-162-964-11	CERAMIC CHIP	0.001 μ F	10%	50V
C6012	1-165-529-11	MYLAR	0.22 μ F	10	275V	C6308	1-100-566-91	CERAMIC CHIP	0.1 μ F	10%	25V
C6014	1-161-964-91	CERAMIC	0.0047 μ F		250V	C6309	1-107-910-11	ELECT	100 μ F	20%	50V
C6015	1-161-964-91	CERAMIC	0.0047 μ F		250V	C6310	1-162-964-11	CERAMIC CHIP	0.001 μ F	10%	50V
C6018	1-119-894-51	CERAMIC	2200pF	20%	250V	C6311	1-131-872-91	CERAMIC CHIP	1000pF	10%	630V
C6019	1-163-021-91	CERAMIC CHIP	0.01 μ F	10%	50V	C6402	1-162-970-11	CERAMIC CHIP	0.01 μ F	10%	25V
C6020	1-163-021-91	CERAMIC CHIP	0.01 μ F	10%	50V	C6403	1-162-970-11	CERAMIC CHIP	0.01 μ F	10%	25V
C6021	1-113-889-11	CERAMIC	0.001 μ F	20%	250V	C6408	1-165-908-11	CERAMIC CHIP	1 μ F	10%	10V
C6100	1-162-970-11	CERAMIC CHIP	0.01 μ F	10%	25V	C6410	1-107-826-11	CERAMIC CHIP	0.1 μ F	10%	16V
C6101	1-100-831-91	CERAMIC CHIP	0.001 μ F	2%	50V	C6411	1-125-891-11	CERAMIC CHIP	0.47 μ F	10%	10V
C6102	1-107-906-11	ELECT	10 μ F	20%	50V	C6500	1-112-744-61	MYLAR	1 μ F	10%	450V
C6103	1-107-905-11	ELECT	4.7 μ F	20%	50V	C6501	1-112-188-11	MYLAR	1.5 μ F	5%	450V
C6104	1-107-910-11	ELECT	100 μ F	20%	50V	C6503	1-112-188-11	MYLAR	1.5 μ F	5%	450V
C6106	1-162-970-11	CERAMIC CHIP	0.01 μ F	10%	25V	C6505	1-162-964-11	CERAMIC CHIP	0.001 μ F	10%	50V
C6107	1-107-888-11	ELECT	47 μ F	20%	25V	C6506	1-162-964-11	CERAMIC CHIP	0.001 μ F	10%	50V
C6108	1-115-340-11	CERAMIC CHIP	0.22 μ F	10%	25V	C6507	1-162-966-11	CERAMIC CHIP	0.0022 μ F	10%	50V
C6111	1-100-310-11	FILM	18000pF	3%	800V	C6508	1-100-566-91	CERAMIC CHIP	0.1 μ F	10%	25V
C6112	1-163-021-91	CERAMIC CHIP	0.01 μ F	10%	50V	C6510	1-107-902-11	ELECT	1 μ F	20%	50V
C6150	1-104-760-11	CERAMIC CHIP	0.047 μ F	10%	50V	C6511	1-164-315-11	CERAMIC CHIP	470pF	5%	50V
C6152	1-112-231-21	ELECT	2200 μ F	20%	16V	C6512	1-162-959-11	CERAMIC CHIP	330pF	5%	50V
C6154	1-112-835-11	ELECT	3300 μ F	20%	25V	C6517	1-100-566-91	CERAMIC CHIP	0.1 μ F	10%	25V
C6157	1-112-231-21	ELECT	2200 μ F	20%	16V	C6518	1-107-908-11	ELECT	33 μ F	20%	50V
C6160	1-162-970-11	CERAMIC CHIP	0.01 μ F	10%	25V	C6519	1-107-906-11	ELECT	10 μ F	20%	50V
C6170	1-112-231-21	ELECT	2200 μ F	20%	16V	C6521	1-107-906-11	ELECT	10 μ F	20%	50V
C6200	1-107-826-11	CERAMIC CHIP	0.1 μ F	10%	16V	CONNECTOR					
C6201	1-162-927-11	CERAMIC CHIP	100pF	5%	50V	\triangle * CN6000	1-793-660-11	PIN, CONNECTOR (PC BOARD)			
C6202	1-107-903-11	ELECT	2.2 μ F	20%	50V	CN6001	1-695-915-11	TAB (CONTACT)			
C6203	1-100-139-41	FILM	0.001 μ F	5%	630V	CN6002	1-695-915-11	TAB (CONTACT)			
C6204	1-107-904-11	ELECT	3.3 μ F	20%	50V	CN6003	1-695-915-11	TAB (CONTACT)			
C6205	1-107-910-11	ELECT	100 μ F	20%	50V	* CN6202	1-785-708-11	PIN, CONNECTOR (PC BOARD)	12P		
C6206	1-162-964-11	CERAMIC CHIP	0.001 μ F	10%	50V	CN6203	1-785-707-11	PIN, CONNECTOR (PC BOARD)	11P		
						* CN6204	1-778-853-11	PIN, CONNECTOR (PC BOARD)	8P		
						* CN6501	1-793-660-11	PIN, CONNECTOR (PC BOARD)			
						* CN6502	1-793-660-11	PIN, CONNECTOR (PC BOARD)			

NOTE: The components identified by shading and \triangle mark are critical for safety. Replace only with part number specified.

NOTE: Les composants identifiés par un trame et une marque \triangle sont critiques pour la sécurité. Ne les remplacer que par une pièce portant le numéro spécifié.

REF. NO.	PART NO.	DESCRIPTION	VALUES	REF. NO.	PART NO.	DESCRIPTION	VALUES	
DIODE				FERRITE BEAD				
	D6000	8-719-054-89	DIODE	D15XB60	FB6000	1-412-911-11	FERRITE	0 μ H
\triangle	D6100	8-719-081-67	DIODE	M1FM3	FB6001	1-412-911-11	FERRITE	0 μ H
	D6101	6-500-137-01	DIODE	BAT54HT1	FB6004	1-410-396-41	FERRITE	0.45 μ H
	D6102	8-719-017-89	DIODE	MA8150-TX	FB6005	1-410-396-41	FERRITE	0.45 μ H
	D6104	8-719-979-64	DIODE	UF4005/23	FB6100	1-412-911-11	FERRITE	0 μ H
\triangle	D6105	8-719-081-67	DIODE	M1FM3	FB6101	1-412-911-11	FERRITE	0 μ H
	D6151	8-719-060-88	DIODE	D4SBS6	FB6150	1-412-911-11	FERRITE	0 μ H
	D6152	6-501-545-01	DIODE	SG10SC6-F5	FB6151	1-412-911-11	FERRITE	0 μ H
\triangle	D6153	6-501-545-01	DIODE	SG10SC6-F5	FB6152	1-412-911-11	FERRITE	0 μ H
	D6201	8-719-058-74	DIODE	05NU42-TPA2	FB6153	1-412-911-11	FERRITE	0 μ H
	D6203	6-500-567-31	DIODE	10ERB20-TB3	FUSE HOLDER			
	D6204	6-500-567-31	DIODE	10ERB20-TB3	\triangle FH6000	1-533-223-11	FUSE HOLDER	0A 0V
	D6206	8-719-404-50	DIODE	MA111-TX	\triangle FH6001	1-533-223-11	FUSE HOLDER	0A 0V
	D6250	8-719-510-02	DIODE	D1NS4	IC			
	D6303	8-719-404-50	DIODE	MA111-TX	\triangle IC6100	6-707-749-01	IC	CXD9841P
	D6304	8-719-404-50	DIODE	MA111-TX	IC6150	6-709-368-01	IC	MM1431ATT (CN)
	D6308	8-719-404-50	DIODE	MA111-TX	\triangle IC6200	6-708-801-01	IC	MIP2H2
	D6309	8-719-404-50	DIODE	MA111-TX	IC6250	6-709-442-01	IC	MM1530ATT
	D6310	8-719-404-50	DIODE	MA111-TX	IC6300	6-709-368-01	IC	MM1431ATT (CN)
	D6311	8-719-018-01	DIODE	MA8220-TX	IC6301	6-709-368-01	IC	MM1431ATT (CN)
	D6312	8-719-058-74	DIODE	05NU42-TPA2	\triangle IC6500	6-709-791-01	IC	L6562N
	D6313	8-719-404-50	DIODE	MA111-TX	CHIP CONDUCTOR			
	D6400	8-719-017-89	DIODE	MA8150-TX	JR6001	1-216-864-11	SHORT CHIP	
	D6401	8-719-404-50	DIODE	MA111-TX	JR6002	1-216-295-91	SHORT CHIP	
	D6402	8-719-404-50	DIODE	MA111-TX	JR6003	1-216-296-11	SHORT CHIP	
	D6404	8-719-404-50	DIODE	MA111-TX	JR6004	1-216-295-91	SHORT CHIP	
	D6500	6-500-108-01	DIODE	EP05FA20	JR6005	1-216-295-91	SHORT CHIP	
	D6501	6-500-108-01	DIODE	EP05FA20	JR6006	1-216-864-11	SHORT CHIP	
	D6502	6-500-137-01	DIODE	BAT54HT1	JR6007	1-216-296-11	SHORT CHIP	
	D6503	8-719-404-50	DIODE	MA111-TX	JR6008	1-216-296-11	SHORT CHIP	
	D6511	8-719-404-50	DIODE	MA111-TX	JR6009	1-216-296-11	SHORT CHIP	
	D6512	8-719-404-50	DIODE	MA111-TX	JR6010	1-216-296-11	SHORT CHIP	
	D6513	6-500-137-01	DIODE	BAT54HT1	JR6011	1-216-295-91	SHORT CHIP	
	ET6000	1-537-770-21	TERMINAL BOARD, GROUND		JR6012	1-216-295-91	SHORT CHIP	
	ET6001	1-537-770-21	TERMINAL BOARD, GROUND		JR6013	1-216-295-91	SHORT CHIP	
	ET6002	1-537-770-21	TERMINAL BOARD, GROUND		JR6014	1-216-295-91	SHORT CHIP	
	ET6003	1-537-770-21	TERMINAL BOARD, GROUND		JR6015	1-216-864-11	SHORT CHIP	
					JR6016	1-216-296-11	SHORT CHIP	
FUSE								
\triangle	F6000	1-576-233-51	FUSE	6.3A	250V			

NOTE: The components identified by shading and \triangle mark are critical for safety. Replace only with part number specified.

NOTE: Les composants identifiés par un trame et une marque \triangle sont critiques pour la sécurité. Ne les remplacer que par une pièce portant le numéro spécifié.

REF. NO.	PART NO.	DESCRIPTION	VALUES	REF. NO.	PART NO.	DESCRIPTION	VALUES
COIL				R6108	1-208-854-11	METAL CHIP	1M 0.50% 1/10W
L6150	1-414-487-41	INDUCTOR	1 μ H	R6109	1-208-854-11	METAL CHIP	1M 0.50% 1/10W
L6151	1-414-487-41	INDUCTOR	1 μ H	\triangle R6110	1-202-933-61	FUSIBLE	0.1 10% 1/2W
L6152	1-457-239-11	INDUCTOR	4.7 μ H	R6111	1-218-760-11	METAL CHIP	220K 0.50% 1/10W
L6250	1-414-183-41	INDUCTOR	10 μ H	R6112	1-218-877-11	METAL CHIP	18K 0.50% 1/10W
L6500	1-457-277-11	INDUCTOR	260 μ H	R6115	1-211-981-11	METAL CHIP	33 0.50% 1/10W
PHOTO COUPLER				R6116	1-216-009-91	RES-CHIP	22 5% 1/10W
PH6100	6-600-187-01	PHOTO COUPLER	PC123Y22JOOF	R6117	1-216-009-91	RES-CHIP	22 5% 1/10W
PH6200	6-600-187-01	PHOTO COUPLER	PC123Y22JOOF	R6118	1-216-833-11	METAL CHIP	10K 5% 1/10W
PH6300	6-600-187-01	PHOTO COUPLER	PC123Y22JOOF	R6119	1-216-833-11	METAL CHIP	10K 5% 1/10W
PH6301	6-600-187-01	PHOTO COUPLER	PC123Y22JOOF	R6120	1-216-361-00	METAL OXIDE	0.22 5% 2W
PH6302	6-600-187-01	PHOTO COUPLER	PC123Y22JOOF	R6121	1-216-361-00	METAL OXIDE	0.22 5% 2W
TRANSISTOR				R6122	1-216-857-11	METAL CHIP	1M 5% 1/10W
\triangle Q6100	6-551-302-01	TRANSISTOR	2SK3561(LBS1SONY,Q)	R6123	1-218-847-11	METAL CHIP	1K 0.50% 1/10W
\triangle Q6101	6-551-302-01	TRANSISTOR	2SK3561(LBS1SONY,Q)	R6150	1-216-821-11	METAL CHIP	1K 5% 1/10W
Q6300	6-551-696-01	TRANSISTOR	ISA1235AC1TP-1EF	R6151	1-216-821-11	METAL CHIP	1K 5% 1/10W
Q6301	8-729-620-07	TRANSISTOR	2SC3052EF-T1-LF	R6152	1-216-821-11	METAL CHIP	1K 5% 1/10W
\triangle Q6303	6-551-678-01	TRANSISTOR	2SA1364-T111-1DE	R6153	1-218-859-11	METAL CHIP	3.3K 0.50% 1/10W
Q6304	8-729-620-07	TRANSISTOR	2SC3052EF-T1-LF	R6154	1-218-875-11	METAL CHIP	15K 0.50% 1/10W
Q6305	8-729-620-07	TRANSISTOR	2SC3052EF-T1-LF	R6155	1-216-845-11	METAL CHIP	100K 5% 1/10W
Q6306	8-729-620-07	TRANSISTOR	2SC3052EF-T1-LF	R6157	1-216-841-11	METAL CHIP	47K 5% 1/10W
Q6307	6-551-696-01	TRANSISTOR	ISA1235AC1TP-1EF	R6158	1-249-389-11	CARBON	4.7 5% 1/4W
Q6405	6-551-696-01	TRANSISTOR	ISA1235AC1TP-1EF	R6159	1-218-863-11	METAL CHIP	4.7K 0.50% 1/10W
Q6406	8-729-620-07	TRANSISTOR	2SC3052EF-T1-LF	R6201	1-218-865-11	METAL CHIP	5.6K 0.50% 1/10W
Q6500	8-729-620-07	TRANSISTOR	2SC3052EF-T1-LF	R6202	1-243-725-71	METAL OXIDE	100K 5% 1W
Q6501	6-551-696-01	TRANSISTOR	ISA1235AC1TP-1EF	R6203	1-249-385-11	CARBON	2.2 5% 1/4W
\triangle Q6502	6-551-336-01	TRANSISTOR	2SK3934(LBS1SONY,Q)	R6250	1-216-821-11	METAL CHIP	1K 5% 1/10W
\triangle Q6503	6-551-336-01	TRANSISTOR	2SK3934(LBS1SONY,Q)	R6251	1-216-827-11	METAL CHIP	3.3K 5% 1/10W
Q6504	8-729-820-90	TRANSISTOR	2SD1621-ST	R6252	1-216-805-11	METAL CHIP	47 5% 1/10W
Q6505	8-729-804-41	TRANSISTOR	2SB1122-S	R6253	1-218-887-11	METAL CHIP	47K 0.50% 1/10W
Q6506	6-551-696-01	TRANSISTOR	ISA1235AC1TP-1EF	R6254	1-218-871-11	METAL CHIP	10K 0.50% 1/10W
RESISTOR				R6255	1-218-867-11	METAL CHIP	6.8K 0.50% 1/10W
\triangle R6009	1-240-251-11	METAL	6.8 5% 10W	R6256	1-216-864-11	SHORT CHIP	
R6014	1-216-857-11	METAL CHIP	1M 5% 1/10W	R6300	1-216-835-11	METAL CHIP	15K 5% 1/10W
R6015	1-216-857-11	METAL CHIP	1M 5% 1/10W	R6301	1-216-833-11	METAL CHIP	10K 5% 1/10W
R6100	1-218-885-11	METAL CHIP	39K 0.50% 1/10W	R6302	1-218-903-11	METAL CHIP	220K 0.50% 1/10W
R6101	1-249-385-11	CARBON	2.2 5% 1/4W	R6303	1-218-885-11	METAL CHIP	39K 0.50% 1/10W
R6102	1-218-863-11	METAL CHIP	4.7K 0.50% 1/10W	R6304	1-218-863-11	METAL CHIP	4.7K 0.50% 1/10W
R6103	1-218-827-11	METAL CHIP	150 0.50% 1/10W	R6305	1-216-833-11	METAL CHIP	10K 5% 1/10W
R6104	1-218-877-11	METAL CHIP	18K 0.50% 1/10W	R6309	1-216-833-11	METAL CHIP	10K 5% 1/10W
R6106	1-208-854-11	METAL CHIP	1M 0.50% 1/10W	R6310	1-216-833-11	METAL CHIP	10K 5% 1/10W
R6107	1-208-854-11	METAL CHIP	1M 0.50% 1/10W	R6311	1-218-863-11	METAL CHIP	4.7K 0.50% 1/10W
				R6312	1-218-887-11	METAL CHIP	47K 0.50% 1/10W
				R6313	1-216-864-11	SHORT CHIP	
				R6315	1-216-829-11	METAL CHIP	4.7K 5% 1/10W



H1	H3	H4
-----------	-----------	-----------

REF. NO.	PART NO.	DESCRIPTION	VALUES			REF. NO.	PART NO.	DESCRIPTION	VALUES		
H1						TRANSISTOR					
	A-1220-318-A	H1 BOARD, MOUNTED				Q301	8-729-028-96	TRANSISTOR	DTC114EUA-T106		
	CONNECTOR					Q302	8-729-028-96	TRANSISTOR	DTC114EUA-T106		
*	CN101	1-820-180-11	HEADER ASSEMBLY (PRINT PWB)			Q303	8-729-028-96	TRANSISTOR	DTC114EUA-T106		
*	CN102	1-819-472-11	HEADER ASSEMBLY FOR PWB			Q304	8-729-028-96	TRANSISTOR	DTC114EUA-T106		
	RESISTOR					Q305	8-729-028-96	TRANSISTOR	DTC114EUA-T106		
R101	1-218-827-11	METAL CHIP	150	0.50%	1/10W	Q320	6-551-699-01	TRANSISTOR	ISA1602AM1TP-1EF		
R102	1-218-831-11	METAL CHIP	220	0.50%	1/10W	RESISTOR					
R103	1-218-835-11	METAL CHIP	330	0.50%	1/10W	R301	1-216-821-11	METAL CHIP	1K	5%	1/10W
R104	1-218-841-11	METAL CHIP	560	0.50%	1/10W	R302	1-216-821-11	METAL CHIP	1K	5%	1/10W
R105	1-218-848-11	METAL CHIP	1.1K	0.50%	1/10W	R303	1-216-821-11	METAL CHIP	1K	5%	1/10W
R107	1-216-864-11	SHORT CHIP				R304	1-216-821-11	METAL CHIP	1K	5%	1/10W
	SWITCH					R305	1-216-825-11	METAL CHIP	2.2K	5%	1/10W
S101	1-572-595-11	SWITCH, TACTILE				R321	1-216-839-11	METAL CHIP	33K	5%	1/10W
S102	1-572-595-11	SWITCH, TACTILE				R322	1-216-821-11	METAL CHIP	1K	5%	1/10W
S103	1-572-595-11	SWITCH, TACTILE				R323	1-216-833-11	METAL CHIP	10K	5%	1/10W
S104	1-572-595-11	SWITCH, TACTILE				R325	1-216-864-11	SHORT CHIP			
S105	1-572-595-11	SWITCH, TACTILE				R326	1-216-847-11	METAL CHIP	150K	5%	1/10W
S106	1-572-595-11	SWITCH, TACTILE				R327	1-216-864-11	SHORT CHIP			
S107	1-572-595-11	SWITCH, TACTILE				R328	1-216-823-11	METAL CHIP	1.5K	5%	1/10W
H3						H4					
	A-1220-319-A	H3 BOARD, MOUNTED				A-1220-320-A	H4 BOARD, MOUNTED				
	CAPACITOR					CAPACITOR					
C320	1-112-781-11	CERAMIC CHIP	1 μ F	10%	10V	C401	1-162-960-11	CERAMIC CHIP	220pF	10%	50V
C322	1-107-826-11	CERAMIC CHIP	0.1 μ F	10%	16V	C402	1-100-909-11	CERAMIC CHIP	10 μ F	10%	6.3V
C323	1-126-205-11	ELECT CHIP	47 μ F	20%	6.3V	CONNECTOR					
	DIODE					* CN401	1-820-297-11	HEADER ASSEMBLY (PRINT PWB)			
D302	8-719-085-26	DIODE	CL-165HR/SYG-D-T			IC					
D305	8-719-085-26	DIODE	CL-165HR/SYG-D-T			IC401	6-600-502-01	HIC	GP1UE26RK0VF		
D308	6-500-817-01	DIODE (LED)	SML-512UWT86			RESISTOR					
	IC					R401	1-216-817-11	METAL CHIP	470	5%	1/10W
IC320	6-600-447-01	IC	TPS853(SONY)			R402	1-216-805-11	METAL CHIP	47	5%	1/10W

NOTE: The components identified by shading and  mark are critical for safety. Replace only with part number specified.

NOTE: Les composants identifiés par un trame et une  sont critiques pour la sécurité. Ne les remplacer que par une pièce portant le numéro spécifique.

U1

REF. NO.	PART NO.	DESCRIPTION	VALUES			REF. NO.	PART NO.	DESCRIPTION	VALUES		
U1						R213	1-216-825-11	METAL CHIP	2.2K	5%	1/10W
A-1220-504-C U1 BOARD, MOUNTED						R215	1-216-857-11	METAL CHIP	1M	5%	1/10W
CAPACITOR						R216	1-216-825-11	METAL CHIP	2.2K	5%	1/10W
C200	1-162-970-11	CERAMIC CHIP	0.01µF	10%	25V	R218	1-216-864-11	SHORT CHIP			
C201	1-162-970-11	CERAMIC CHIP	0.01µF	10%	25V	R219	1-216-864-11	SHORT CHIP			
C202	1-112-781-11	CERAMIC CHIP	1µF	10%	10V	R220	1-216-864-11	SHORT CHIP			
C203	1-162-970-11	CERAMIC CHIP	0.01µF	10%	25V	R222	1-216-864-11	SHORT CHIP			
C206	1-100-912-11	CERAMIC CHIP	1µF	10%	25V	VARISTOR					
C209	1-100-912-11	CERAMIC CHIP	1µF	10%	25V	VD201	1-804-988-21	VARISTOR, CHIP	(1608)		
C215	1-162-964-11	CERAMIC CHIP	0.001µF	10%	50V	VD202	1-804-988-21	VARISTOR, CHIP	(1608)		
C218	1-162-964-11	CERAMIC CHIP	0.001µF	10%	50V	VD203	1-804-988-21	VARISTOR, CHIP	(1608)		
CONNECTOR						VD204	1-804-988-21	VARISTOR, CHIP	(1608)		
* CN201	1-819-928-11	HEADER ASSEMBLY			20P	VD205	1-804-988-21	VARISTOR, CHIP	(1608)		
CN202	1-695-915-11	TAB (CONTACT)				VD206	1-804-988-21	VARISTOR, CHIP	(1608)		
DIODE						VD207	1-804-988-21	VARISTOR, CHIP	(1608)		
D203	8-719-423-03	DIODE			MA8100	ACCESSORIES AND PACKING					
D204	8-719-423-03	DIODE			MA8100		1-831-499-21	POWER-SUPPLY CORD SET			
EARTH TERMINAL								(KDL-26S3000/32S3000 ONLY)			
ET201	1-780-482-11	EARTH TERMINAL					1-832-937-11	AC POWER-SUPPLY CORD SET			
ET202	1-780-482-11	EARTH TERMINAL						(KDL-40S3000/46S3000 ONLY)			
JACK						* X-2102-511-2		BAG ASSY, RUDDER LOCK			
J201	1-780-489-11	S TERMINAL BLOCK (RIGHT)					X-2055-089-2	LOCK ASSY, RUDDER (Strap)			
J202	1-815-325-11	JACK						(Contains the Belt)			
RESISTOR							2-591-689-01	BELT			
R200	1-218-831-11	METAL CHIP	220	0.50%	1/10W		2-593-320-02	SCREW, CION (M6X18)			
R201	1-218-831-11	METAL CHIP	220	0.50%	1/10W		2-580-663-01	SCREW, WOOD 3.8X20			
R202	1-218-831-11	METAL CHIP	220	0.50%	1/10W	* 2-678-263-01		BAG, PROTECTION			
R203	1-216-809-11	METAL CHIP	100	5%	1/10W			(KDL-26S3000 ONLY)			
R204	1-218-285-11	METAL CHIP	75	5%	1/10W	* 2-678-264-01		BAG, PROTECTION			
R205	1-216-809-11	METAL CHIP	100	5%	1/10W			(KDL-32S3000 ONLY)			
R206	1-216-821-11	METAL CHIP	1K	5%	1/10W	* 2-678-265-01		BAG, PROTECTION			
R207	1-216-821-11	METAL CHIP	1K	5%	1/10W			(KDL-40S3000 ONLY)			
R208	1-218-831-11	METAL CHIP	220	0.50%	1/10W	* 2-678-266-01		BAG, PROTECTION			
R209	1-218-831-11	METAL CHIP	220	0.50%	1/10W			(KDL-46S3000 ONLY)			
R210	1-218-831-11	METAL CHIP	220	0.50%	1/10W	* 3-113-038-01		CARTON, INDIVIDUAL			
R211	1-216-809-11	METAL CHIP	100	5%	1/10W			(KDL-26S3000 ONLY)			
R212	1-216-857-11	METAL CHIP	1M	5%	1/10W	* 2-319-958-01		CARTON, INDIVIDUAL			
								(KDL-32S3000 ONLY)			
						* 2-319-962-01		CARTON, INDIVIDUAL			
								(KDL-40S3000 ONLY)			
						* 3-093-192-01		CARTON, INDIVIDUAL			
								(KDL-46S3000 ONLY)			
						* 3-211-986-01		CARTON, INDIVIDUAL			
								(KDL-46S3000 ONLY)			

REF. NO.	PART NO.	DESCRIPTION	VALUES	REF. NO.	PART NO.	DESCRIPTION	VALUES
	2-595-155-02	CLAMP				<u>REMOTE COMMANDER</u>	
	1-500-915-11	CLAMP FILTER (FERRITE, CORE) (KDL-40S3000/46S3000 ONLY)			1-480-262-11	REMOTE COMMANDER (RM-YD018)	
*	2-319-961-02	CUSHION, LOWER (KDL-26S3000/32S3000 ONLY)					
*	2-319-966-02	CUSHION, LOWER (KDL-40S3000 ONLY)					
*	3-093-196-02	CUSHION, LOWER (KDL-46S3000 ONLY)					
*	3-211-990-01	CUSHION, LOWER (KDL-46S3000 ONLY)					
*	2-319-960-01	CUSHION, UPPER (KDL-26S3000/32S3000 ONLY)					
*	2-319-965-01	CUSHION, UPPER (KDL-40S3000 ONLY)					
*	3-093-195-01	CUSHION, UPPER (KDL-46S3000 ONLY)					
*	3-211-989-01	CUSHION, UPPER (KDL-46S3000 ONLY)					
	3-196-473-11	GUIDE, QUICK SETUP (English Version)					
	3-196-473-21	GUIDE, QUICK SETUP (French Version)					
	3-196-473-31	GUIDE, QUICK SETUP (Spanish Version)					
	3-196-472-12	MANUAL, INSTRUCTION (English Version)					
	3-196-472-22	MANUAL, INSTRUCTION (French Version)					
	3-196-472-32	MANUAL, INSTRUCTION (Spanish Version)					
*	3-216-083-01	SHEET, PROTECTION (STAND) (KDL-26S3000 ONLY)					
*	2-319-963-01	TRAY (KDL-40S3000 ONLY)					
*	3-093-193-01	TRAY (KDL-46S3000 ONLY)					
*	3-211-987-01	TRAY (KDL-46S3000 ONLY)					
*	2-319-964-01	TRAY, TOP (KDL-40S3000 ONLY)					
*	3-093-194-01	TRAY, TOP (KDL-46S3000 ONLY)					
*	3-211-988-01	TRAY, TOP (KDL-46S3000 ONLY)					