











Faucet Spout End Devices





BASYS EFX-9/EFX-10

Part No.	Code No.	Flow Rate
EFX-1002-A	3324104	0.5 gpm (1.9 Lpm)
Spray Insert Kit w/Key and Hex Key		
EFX-10001-A	3324103	1.5 gpm (5.7 Lpm)
Spray Insert Kit w/Key and Hex Key		
EFX-1000-A	3324102	1.5 gpm (5.7 Lpm)
LAM		

ETF-80/ETF-880/ETF-770 – EBF-85/EBF-187 – SF-2200/SF-2250 (THREAD SIZE 55/64"-27)

Part No.	Code No.	Flow Rate
ETF-839	0365793	0.35 gpm (1.3 Lpm)
Multi-Laminar Female Thread VR w/Key		
ETF-1021-A	3365091	0.5 gpm (1.9 Lpm)
Multi-Laminar Spray Female Thread VR w/Key		
ETF-1022-A	3365090	2.2 gpm (8.3 Lpm)
AER Female Thread VR w/Key		
ETF-1027-A	3365160	2.2 gpm (8.3 Lpm)
LAM Female Thread VR w/Key		
ETF-1028-A	3365161	1.5 gpm (5.6 Lpm)
LAM Female Thread VR w/Key		
ETF-1038-A	3365755	0.35 gpm (1.3 Lpm)
Multi-Laminar Female Thread VR w/Key		
SFP-14	0362014	2.2 gpm (8.3 Lpm)
LAM Female Thread		

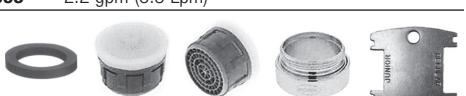
ETF-600/ETF-610/ETF-660 – EBF-615/EBF-625/EBF-650/EBF-655 – ELF-10 (THREAD SIZE 15/16"-27)

EAF-10	0335008	2.2 gpm (8.3 Lpm)
LAM Male Thread		
ETF-688	0365395	1.5 gpm (5.6 Lpm)
LAM Male Thread VR w/Key		
ETF-1023-A	3365092	0.5 gpm (1.9 Lpm)
Multi-Laminar Spray Male Thread VR w/Key		
ETF-1024-A	3365093	2.2 gpm (8.3 Lpm)
AER Male Thread VR w/Key		
ETF-1029-A	3365162	2.2 gpm (8.3 Lpm)
LAM Male Thread VR w/Key		
ETF-1039-A	3365756	0.35 gpm (1.3 Lpm)
Multi-Laminar Male Thread VR w/Key		

Key: LAM – Laminar
 AER – Aerated
 VR – Vandal Resistant
 JR – Junior

Faucet Spout End Devices



EAF SERIES - SF-2100/SF-2150/SF-2300/SF-2350/SF-2400/SF-2450 (THREAD SIZE M24)

Part No.	Code No.	Flow Rate
EAF-12	0335010	0.5 gpm (1.9 Lpm)
Multi-Laminar Spray Metric Male Thread		
EAF-13	0335011	2.2 gpm (8.3 Lpm)
LAM Metric Male Thread		
EAF-15	0335012	0.5 gpm (1.9 Lpm)
Multi-Laminar Metric Male Thread VR w/Key		
EAF-22	0335021	1.5 gpm (5.6 Lpm)
AER Metric Male Thread		
EAF-51	0335029	0.35 gpm (1.3 Lpm)
Multi-Laminar Metric Male Thread		
SFP-13	0362013	0.5 gpm (1.9 Lpm)
Multi-Laminar Spray Metric Male Thread		
SFP-23	0362023	2.2 gpm (8.3 Lpm)
AER Metric Male Thread		
SFP-24	0362024	2.2 gpm (8.3 Lpm)
AER Metric Male Thread VR w/Key		
SFP-1000	3362000	0.35 gpm (1.3 Lpm)
Multi-Laminar Metric Male Thread VR w/Key		
AER Metric Male Thread	Not Shown	
EAF-63	0335036	0.5 gpm (1.9 Lpm)

SLOANSTONE EW-72000/73000 SERIES (THREAD SIZE 13/16"-27)

Part No.	Code No.	Flow Rate
ETF-1037-A	3365747	1.0 gpm (3.8 Lpm)
Multi-Laminar Spray JR Male Thread VR w/Key		



ETF-500/ETF-700 SERIES – ETF-800 – ESF-20/ESF-30/ESF-40 (THREAD SIZE 3/4"-27)

Part No.	Code No.	Flow Rate
ETF-621	0365147	2.2 gpm (8.3 Lpm)
LAM JR Female Thread		
ETF-687	0365387	1.5 gpm (5.6 Lpm)
LAM JR Female Thread		
ETF-801	0365420	0.5 gpm (1.9 Lpm)
Multi-Laminar Spray JR Female Thread		

INSERT ONLY

ETF-689	0365381	1.5 gpm (5.6 Lpm)
LAM Spray Head Insert		
ETF-843	0365437	0.5 gpm (1.9 Lpm)
Multi-Laminar Spray Head Insert		

VANDAL RESISTANT SPRAY HEAD REMOVAL KEY

Part No.	Code No.
ETF-435	0305927PK
Regular/JR Size VR Removal Key	
ETF-731	0365736
Regular/JR Size VR Removal Key	

Key: LAM – Laminar
AER – Aerated
VR – Vandal Resistant
JR – Junior