

BASYS® Faucet Infrared Sensor Activated

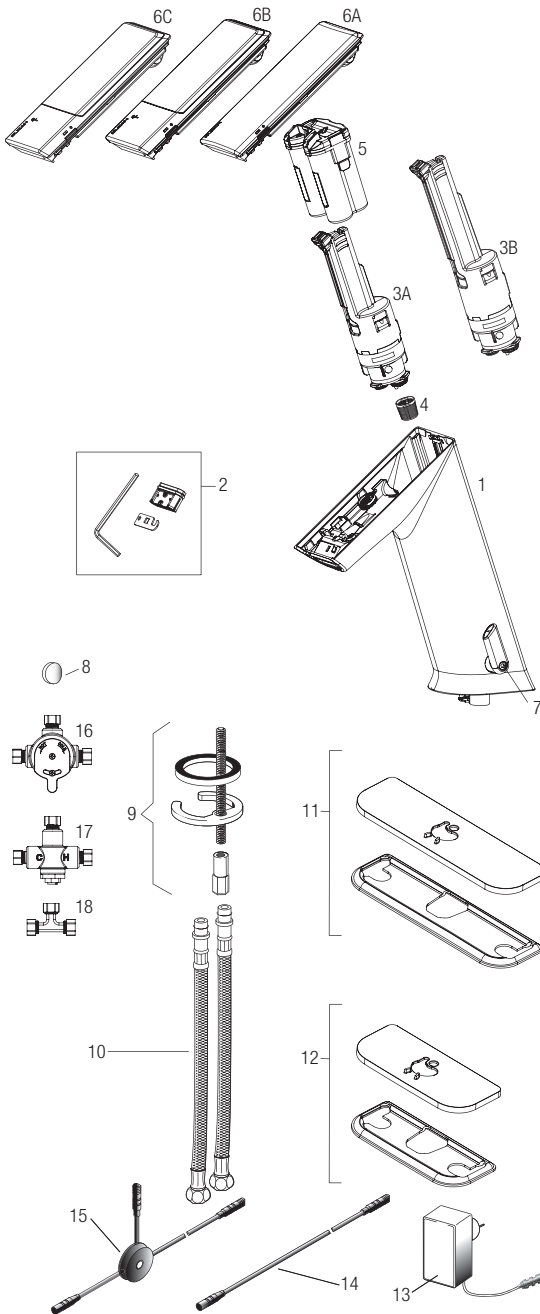

PARTS LIST—BASYS FAUCETS

Item No.	Code No.	Part No.	Description
1.	—	—	Mid Mount Faucet Assembly
	—	—	Mid Mount Faucet Assembly with Mixer
	—	—	High Mount Faucet Assembly
	—	—	High Mount Faucet Assembly with Mixer
2.	3324104	EFX-1002-A	0.5 gpm/1.9 Lpm Multi-Lam Insert (includes insert, o-ring, 2.5 mm allen key and removal tool)
	3324103	EFX-1001-A	1.5 gpm/5.7 Lpm Aerated Stream Insert (includes insert, o-ring, 2.5 mm allen key and removal tool)
	3324102	EFX-1000-A	1.5 gpm/5.7 Lpm Laminar Stream Insert (includes insert, o-ring, 2.5 mm allen key and removal tool)
3A.	3324122	EFX-15-A	0.5 gpm/1.9 Lpm Solenoid Valve Caddy Assembly – Mid Mount (Green)
	3324123	EFX-16-A	1.5 gpm/5.7 Lpm Solenoid Valve Caddy Assembly – Mid Mount (Blue)
3B.	3324124	EFX-17-A	0.5 gpm/1.9 Lpm Solenoid Valve Caddy Assembly – High Mount (Green)
	3324125	EFX-18-A	1.5 gpm/5.7 Lpm Solenoid Valve Caddy Assembly – High Mount (Blue)
4.	0324019	EFX-19	Strainer (Filter)
5.	3324128	EFX-7-A	Battery Pack Assembly
6A.	3324118	EFX-1-A	Crown Assembly
6B.	3324119	EFX-3-A	Solar Crown Assembly
6C.	3324120	EFX-4-A	Solar Crown with LCD Assembly
7.	3324133	EFX-24-A	Mixer Handle Assembly
8.	3324134	EFX-25A	Handle Cap Kit (bag of 5)
9.	0335000	EAJ-1	Faucet Mounting Kit (Pedestal)
10.	3335023	EAJ-1008	13" (330 mm) Flexible Supply Hose (1)
11.	3324101	EFX-26-A	Trim Plate for 8" Centerset Sink
12.	3324100	EFX-20-A	Trim Plate for 4" Centerset Sink
13.	0335009	EAJ-11	Plug-in Voltage Adapter (US)
	0335041	EAJ-41	Plug-in Voltage Adapter (EU)
	0335039	EAJ-39	Plug-in Voltage Adapter (UK)
	0335037	EAJ-37	Box Type Voltage Adapter
14.	0335024	EAJ-24-A	11-13/16" (300 mm) Extension Cable
	0335025	EAJ-25-A	47-1/4" (1200 mm) Extension Cable
	0335015	EAJ-17-A	126" (3200 mm) Extension Cable
15.	0335023	EAJ-23-A	Splitter
16.	3326009	MIX-60-A	Mechanical, Below Deck Mixing Valve
17.	0326045	MIX-135-A	Thermostatic, Below Deck Mixing Valve
18.	3365461	ETF-617-A	Bak-Chek Tee

NOTE: If changing flow rate caddy and spray insert must be changed in conjunction.
 — in Item No. column = Not shown in illustration
 — in Code No. and Part No. column = Not sold separately

Electrical Connection for up to Six (6) Faucets Using One (1) Adapter

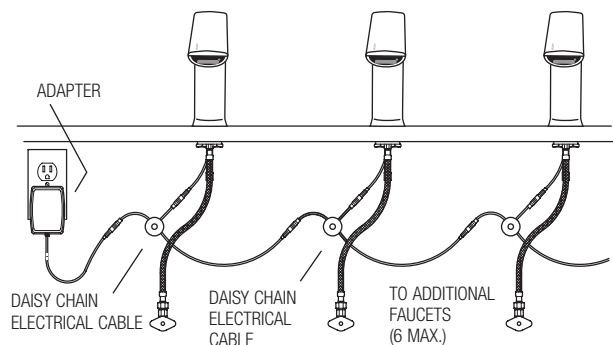

BASYS® Faucet Infrared Sensor Activated

OPERATION

As the user's hands enter the beam's effective range, the beam is reflected back into the sensor receiver and activates the solenoid valve allowing water to flow from the faucet. Water will flow until the hands are removed or until the faucet reaches its automatic time out limit setting.

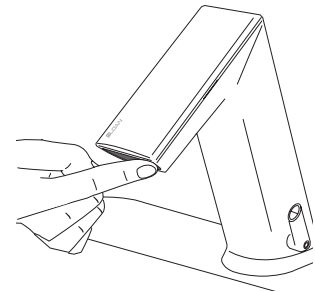
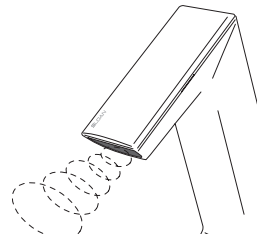

SET AND FIX TEMPERATURE AND ADJUST HOT LIMIT STOP

Adjust lever to set temperature.

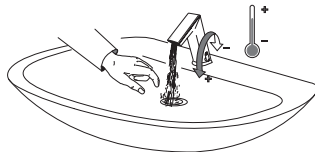

Optional — To fix temperature, set lever to the desired position, then remove lever and plug hole with Cap.

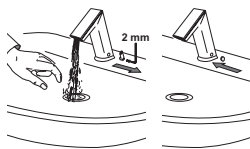

Optional Hot Limit Stop Adjustment — To adjust the hot/cold mix (factory set at 50/50) remove the lever.



Check to make sure dot is in center position before beginning adjustment.



Faucet may be adjusted in 10° increments.



Function	Steps to Activate Function	Default Setting	IR Clic
IR Activation	Cover IR clic approximately for 2 sec. until LED will flash GREEN 1x - then remove finger from IR clic (Active for 5 sec.)	—	—
Cleaning Mode	IR activation; Cover IR clic 2x - confirmation of the function is active by a couple flashes by the LED; to return to normal operation cover IR clic 1x or the faucet will automatically return to normal function after 2 min.	2 min.	—
12/24 Line Purge Feature	See below.	Off	Off 12HR 24HR
Sensor Range Adjustment	See page 123.	6	1-8
Reset Electronics	IR activation; Cover IR clic 2x; LED will flash 5x Cover IR clic 1x for 5 sec. until LED flashes 4x, then remove finger from IR clic Wait for 20 sec. (After 10 sec. water will flow for 6 sec. and automatically adjust to environment)	Manually	—
Security Off	After 90 seconds (max) of hand and/or object within sensor appears permanent, waterflow will stop and will remeasure environment	On	—

Please contact factory for more extensive programming options.

12/24 LINE PURGE FEATURE

This feature will operate the faucet every 12 or 24 hours since last use, if not used to prevent stagnant water conditions.

Default purge duration is two minutes.

Consult factory regarding other timing options.

IR activation (see above). Cover IR clic approximately 24 sec. (ignore LED indications during this period). Release when requested program is reached. (See diagram to right). Programming mode will time out after 2 minutes if no changes are made.

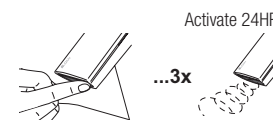
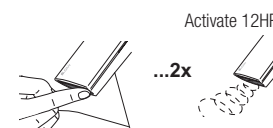
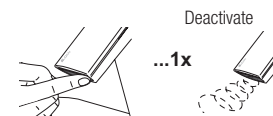
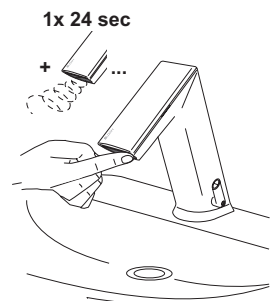

BASYS® Faucet Infrared Sensor Activated

SENSOR RANGE ADJUSTMENT

Factory setting is appropriate for the majority of applications and should not require resetting unless under extreme situations.

IR Activation (see previous page). To enter programming mode place finger on IR clic 2 times then remove. Light on side of crown should blink to indicate programming mode.

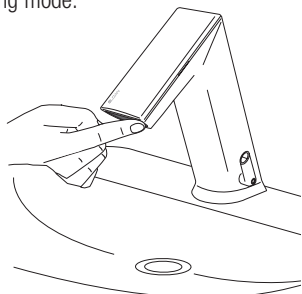

Cover IR clic until LED flashes 4x - hold until LED flashes 1x to 8x, from minimum to maximum. See diagram below. Release when requested range is reached.

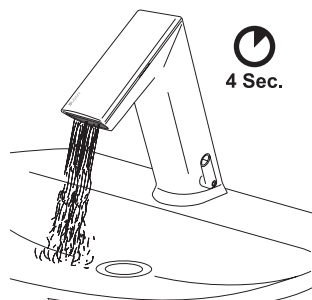
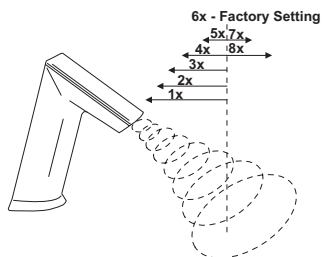

Wait, until LED flashes GREEN.

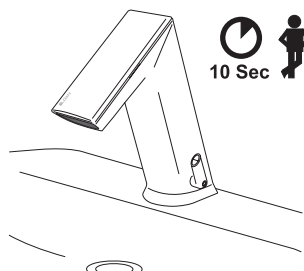

BATTERY REPLACEMENT

NOTE: Replace Battery when LED1 indicator flashes red each time faucet is in use or when faucet stops functioning. LED1 is identified by the battery symbol.

NOTE: Turning off water is not necessary.

Remove crown by loosening hex screw located on underside of spout and slide crown down and lift off.

NOTE: Screw is captive within faucet body and will not fall out.

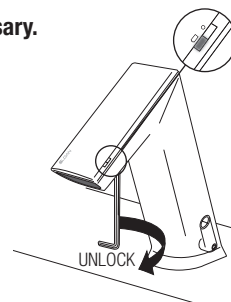

Remove battery pack assembly by lifting out of spout.

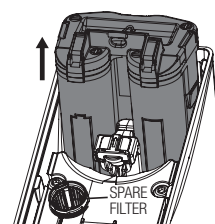

Open battery pack assembly by pushing in tabs on side of assembly.

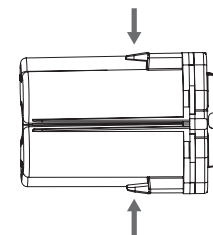

Remove (4) AA-cell batteries from battery pack.

Insert four (4) NEW AA-cell batteries into battery pack assembly cartridge.

NOTE: Insure batteries are installed with proper polarity. The cover of the case indicates polarity of batteries. Improper polarity will not harm the faucet. Improper polarity will cause the faucet not to operate.

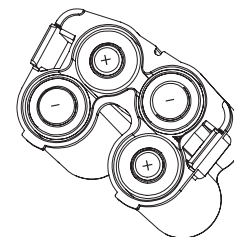

Replace cover of the battery pack assembly and reinsert assembly into faucet.

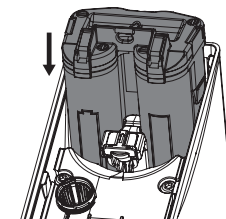

Slide on crown and secure.

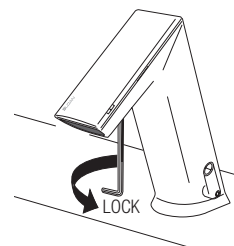

BASYS® Faucet Infrared Sensor Activated

REPLACE SPRAY INSERT

NOTE: Turning off water is not necessary, due to integrated automatic stop valve.

Remove crown by loosening hex screw located on underside of spout and slide crown down and lift off.

NOTE: Screw is captive within faucet body and will NOT fall out.

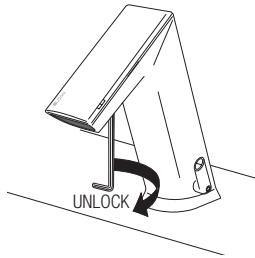

Retrieve spray removal tool located near the spray insert.

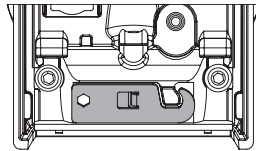

Insert spray removal tool into spray slot by sliding hook end of key between faucet spout and insert. Pull insert out of faucet once hooked.

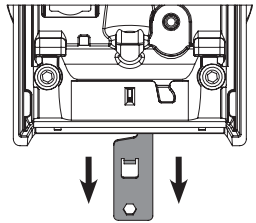

Install new insert.

NOTE: If changing to a different flow rate solenoid caddy must be changed in conjunction.

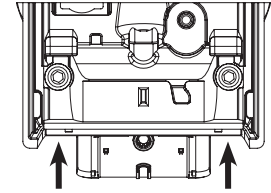

Return spray removal tool to storage location.

NOTE: This can only be done once spray head is installed. This will lock the spray head in place.

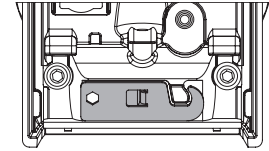

NOTE: If spray head is inserted incorrectly – key will not lock in properly. Turn faucet on to push insert out and re-install.

Slide on crown and secure.

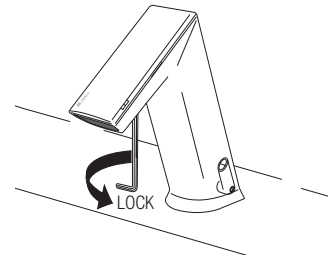

BASYS® Faucet Infrared Sensor Activated

TROUBLESHOOTING GUIDE

1. Red LED in spout does not blink 2 sec after battery installation.

- Battery placement incorrect or batteries have been discharged.
- Ensure batteries are installed properly. Check the orientation of each battery matches the positive (+) and negative (–) symbols shown on the battery compartment.

2. Faucet DOES NOT function.

- Adhesive packaging label affixed over sensor eye.
- Remove adhesive label from sensor eye.

3. Faucet delivers water in an uncontrolled manner.

- Clean sensor window. If continually not working contact Sloan Tech Support.

4. Faucet DOES NOT deliver any water when sensor is activated.

INDICATOR: Solenoid valve produces an audible “CLICK”.

- Water supply stop(s) closed.
Open water supply stop(s).
- Strainer is clogged.
Remove, clean, and reinstall strainer. Replace strainer, if needed (refer to page 151).

INDICATOR: Solenoid valve DOES NOT produce an audible “CLICK”.

- Batteries low (battery-powered models).
Replace batteries (refer to battery replacement on page 151).
- Power failure (hardwire models).
Check power supply.

5. Faucet delivers only a slow flow or dribble when sensor is activated.

- Water supply stop(s) are partially closed.
Completely open water supply stop(s).

6. Faucet DOES NOT stop delivering water or continues to drip after user is no longer detected.

- Clean sensor window. If continually now working contact Sloan's Technical Support (see below).

7. LED indicator blinks RED when faucet is in use.

- Batteries low (battery-powered models).
- Replace batteries (refer to battery replacement on page 151).

8. The water temperature is too hot or too cold on a faucet connected to hot and cold water supply lines.

- Supply stops are not adjusted properly.
Adjust supply stops.
- For models with integral side mixing valve—mixing valve is set improperly for the water temperature desired.
Rotate mixing valve handle clockwise to decrease water temperature or counterclockwise to increase water temperature.
- Inadequate hot water supply.
Adjust supply stops.

CARE AND CLEANING

DO NOT USE abrasive or chemical cleaners (including chlorine bleach) to clean Faucets that may dull the luster and attack the chrome or special decorative finishes. Use **ONLY** mild soap and water, then wipe dry with clean cloth or towel.

While cleaning the bathroom tile, protect the Faucet from any splattering of cleaner. Acids and cleaning fluids will discolor or remove chrome plating.

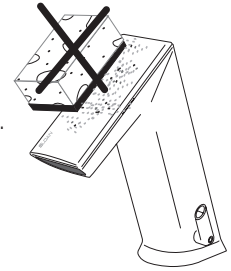

**When assistance is required, please contact
Sloan Technical Support at: 1-888-SLOAN-14 (1-888-756-2614).**

BASYS® Faucet Infrared Sensor Activated

UPGRADE FAUCET FUNCTIONALITY

Remove crown by loosening hex screw located on underside of spout and slide crown down and lift off.

NOTE: Screw is captive within faucet body and will NOT fall out.

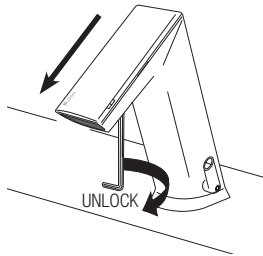

Place new crown on faucet by sliding onto spout and tightening hex screw on underside of spout.

NOTE: All electronics are fully encapsulated in the crown and thus protected from the environment and easy to replace or upgrade.

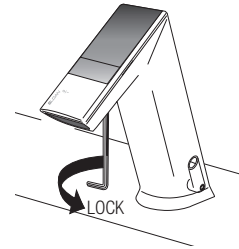
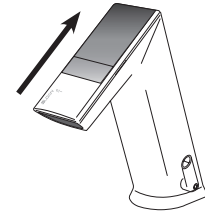

LED DISPLAY DIAGNOSTIC CODES

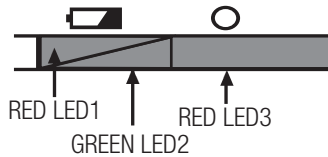

RED **GREEN** COLOR LEDs BLINKING

RED **GREEN** COLOR LEDs ON

Function	LED1	LED2	LED3	Description 1	Description 2
Start Up Boot	RED	GREEN		LED1 and LED2 alternate blinking	Fast Toggle
Battery Check after Start Up	RED			LED1 on for 2 sec, if battery greater than 3.5V	
Line Power Check after Start Up			RED	LED3 on for 2 sec, if line power greater than 3.5V	
IR Adjust Process	RED			LED1 blinking while IR adjusts	Few seconds
IR Adjust IR		GREEN		LED2 on for 2 sec, if adjustment OK	
Battery Low	RED			LED1 blinks 3x, if battery is less than warning level	Only while in detection mode
Battery Empty	RED			LED1 double flashes 3x, if battery is less than empty level	Only while in detection mode
Valve Error			RED	LED3 double flashes 3x, if valve current error; flash after the 3rd error, off after the 3rd good operation	Flashes after the 3rd error, off after the 3rd good operation
IR Activation		GREEN		LED2 on for 2 sec, if IR-clic has been activated	After 5 sec. automatically back to operating mode
Cleaning Mode	RED			LED1 4-in-1 flash, if cleaning mode is activated	During "Cleaning Mode" is activated Permanent 4-in-1 flashes

