

Control Stop



CONTROL STOP AND REPLACEMENT PARTS

H-700 Series Bak-Chek® control stops and replacement parts (available for 3/4" and 1" water supply inlet pipes)
Replaces H-600 and H-540 Series control stops

Code No. Part No. Description

H-700 Stop, chrome plated: Screwdriver Angle Stop with H-1010-A Vandal Resistant Cap

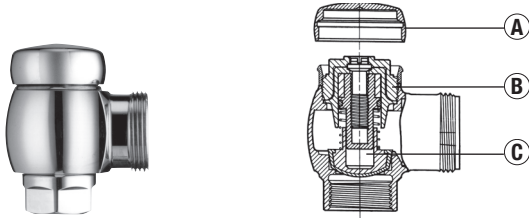

Complete Stops

3308384	H-700-A	3/4" NPTF inlet for adjustable tail
3308386	H-700-A	1" NPTF inlet for adjustable tail
3308385	H-700-AG	3/4" NPTF inlet for ground joint tail
3308387	H-700-AG	1" NPTF inlet for ground joint tail
3308388	H-700-AW	1" Whitworth inlet for adjustable tail

Repair Parts

3308772	H-1010-A	A Vandal Resistant Cap*, chrome plated
0308612	H-622	B Bonnet, chrome plated
3308853	H-541-ASD	C Control Stop Repair Kit*

H-710 Stop, chrome plated: Screwdriver Angle Stop with H-573-A Locking Vandal Resistant Cap

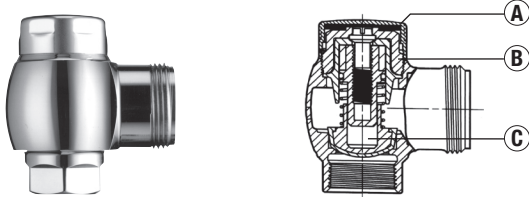

Complete Stops

0388025	H-710-A	3/4" NPTF inlet for adjustable tail
0388022	H-710-A	1" NPTF inlet for adjustable tail
0388026	H-710-AG	3/4" NPTF inlet for ground joint tail
0388024	H-710-AG	1" NPTF inlet for ground joint tail
0388037	H-710-AW	1" Whitworth inlet for adjustable tail
0388062	H-710-AAR	1" BSP British Standard Pipe inlet for adjustable tail
0388043	NH-710-A	1" NPTF inlet for adjustable tail (Naval brass)
0388048	NH-710-AG	3/4" NPTF inlet for ground joint tail (Naval brass)
0388058	NH-710-AG	1" NPTF inlet for ground joint tail (Naval brass)
0388042	NH-710-AW	1" Whitworth inlet for adjustable tail (Naval brass)
0388045	NH-710-AGW	1" Whitworth inlet for ground joint tail (Naval brass)
0388044	NH-710-AGS	1" NPSM inlet for ground joint tail (Naval brass)

Repair Parts

3308840	H-573-A	A Locking Vandal Resistant Cap*, chrome plated
0308612	H-622	B Bonnet, chrome plated
3308853	H-541-ASD	C Control Stop Repair Kit*

H-720 Stop, chrome plated: Screwdriver Angle Stop with H-574 Short bumper Cap (-YO Variation)

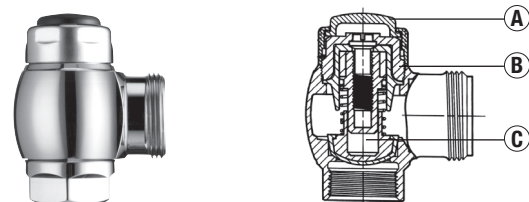

Complete Stops

0388034	H-720-A	1" NPTF inlet for adjustable tail
0388033	H-720-AG	1" NPTF inlet for ground joint tail
0388038	H-720-AW	1" Whitworth inlet for adjustable tail

Repair Parts

3308866	H-574	A Stop Cap with Seat Bumper*, chrome plated
0308612	H-622	B Bonnet, chrome plated
3308853	H-541-ASD	C Control Stop Repair Kit*

*Refer to page 98 for diagrams of our Stop Caps and page 99 for the components supplied in our Control Stop Repair Kits.

Control Stop

CONTROL STOP AND REPLACEMENT PARTS

H-725 Stop, chrome plated: Screwdriver Angle Stop with H-576 Extended Bumper Cap (-YG Variation)

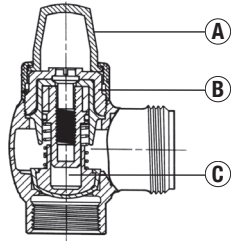

Complete Stops

0388035	H-725-A	1" NPTF inlet for adjustable tail
0388057	H-725-AG	1" NPTF inlet for ground joint tail
0388039	H-725-AW	1" Whitworth inlet for adjustable tail
0388047	NH-725-AGW	1" Whitworth inlet for ground joint tail (Naval brass)

Repair Parts

3308867	H-576	A Stop Cap with Extended Seat Bumper chrome plated
0308612	H-622	B Bonnet, chrome plated
3308853	H-541-ASD	C Control Stop Repair Kit*

H-730 Stop, rough brass: Concealed Wheel Handle Angle Stop

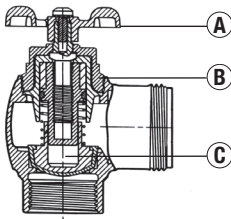
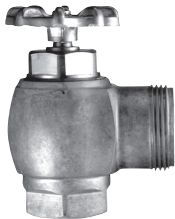

Complete Stops

0388011	H-730-A	3/4" NPTF inlet for adjustable tail
0388010	H-730-A	1" NPTF inlet for adjustable tail
0388014	H-730-AG	3/4" NPTF inlet for ground joint tail
0388013	H-730-AG	1" NPTF inlet for ground joint tail
0388012	H-730-AW	1" Whitworth inlet for adjustable tail
0388056	NH-730-AG	3/4" NPTF inlet for ground joint tail (Naval brass)
0388017	NH-730-AG	1" NPTF inlet for ground joint tail (Naval brass)
0388041	NH-730-AW	1" Whitworth inlet for adjustable tail (Naval brass)
0388046	NH-730-AGW	1" Whitworth inlet for ground joint tail (Naval brass)

Repair Parts

3308872	H-1011-A	A Concealed Wheel Handle Repair Kit*
0208083	H-623	B Bonnet, rough brass
3308860	H-1006-A	C Control Stop Repair Kit*

H-735 Stop, chrome plated: Exposed Wheel Handle Angle Stop

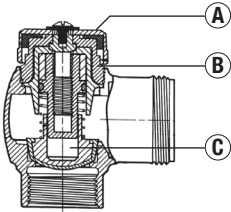

Complete Stops

0388007	H-735-A	3/4" NPTF inlet for adjustable tail
0388006	H-735-A	1" NPTF inlet for adjustable tail
0388009	H-735-AG	3/4" NPTF inlet for ground joint tail
0388008	H-735-AG	1" NPTF inlet for ground joint tail

Repair Parts

3308060	H-1002-A	A Exposed Wheel Handle Repair Kit*
0308615	H-623	B Bonnet, chrome plated
3308855	H-541-AWH	C Control Stop Repair Kit*

*Refer to page 109 for diagrams of Stop Caps and page 110 for the components supplied in our Control Stop Repair Kits.

Control Stop

CONTROL STOP AND REPLACEMENT PARTS

H-740 Stop, chrome plated: Screwdriver Angle Stop with H-37 Cap (Regal® Valve Stop) – DISCONTINUED
H-790 Stop, chrome plated: Screwdriver Angle Stop with Vandal Resistant Cap (for Regal or Regal XL Valve Stop)

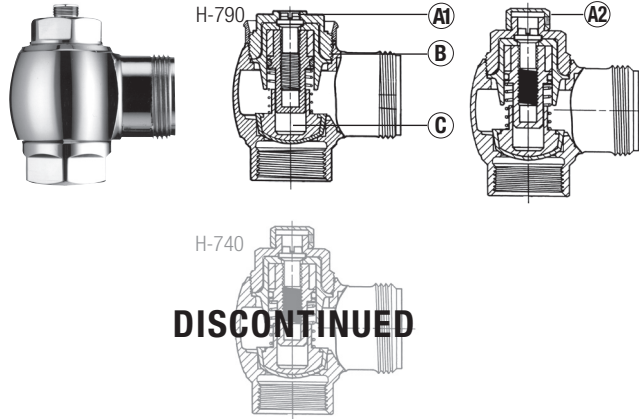

Code No.	Part No.	Description
----------	----------	-------------

Complete Stops For Regal® flushometers

0388031	H-740-A	3/4" NPTF inlet for adjustable tail – DISCONTINUED
0388029	H-740-A	1" NPTF inlet for adjustable tail – DISCONTINUED
0388040	H-740-AG	3/4" NPTF inlet for ground joint tail – DISCONTINUED
0388028	H-740-AG	1" NPTF inlet for ground joint tail – DISCONTINUED

Complete Stops For Regal® "XL" flushometers

0388064	H-790-A	3/4" NPTF inlet for adjustable tail
0388065	H-790-A	1" NPTF inlet for adjustable tail
0388068	H-790-AG	3/4" NPTF inlet for ground joint tail
0388067	H-790-AG	1" NPTF inlet for ground joint tail

Repair Parts

5388002	H-528	Ⓐ Hole Plug
5388001	H-1012-A	Ⓐ Vandal Resistant Socket Cap*, chrome plated with set screw, for Regal "XL" flushometer – 6 per package
0308612	H-622	Ⓑ Bonnet, chrome plated
3308853	H-541-ASD	Ⓒ Control Stop Repair Kit*

H-745 Stop, chrome plated: Screwdriver Angle Stop with J-2/J-7 Bumper (for Regal® Valve Stop) (-Y0/-YG Variations) – DISCONTINUED

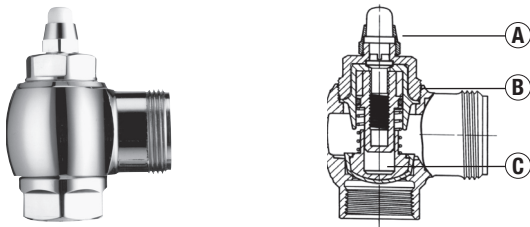

Complete Stops

0388035	H-725-A	1" NPTF inlet for adjustable tail
---------	---------	-----------------------------------

Repair Parts

5310034	J-2/J-7	Ⓐ Cap*, chrome plated – 6 per package DISCONTINUED
0308991	H-639	Ⓑ Bonnet, chrome plated – DISCONTINUED
3308853	H-541-ASD	Ⓒ Control Stop Repair Kit* – DISCONTINUED

H-750 Stop, chrome plated: Screwdriver Straight Stop with H-1010-A Vandal Resistant Cap

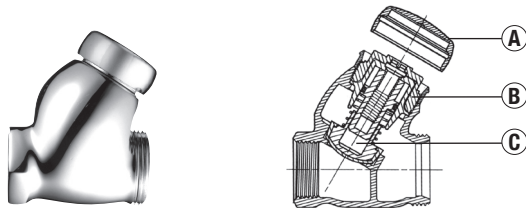

Complete Stops

3308389	H-750-AG	1" NPTF inlet for ground joint tail
---------	----------	-------------------------------------

Repair Parts

3308772	H-1010-A	Ⓐ Vandal Resistant Cap*, chrome plated
0308612	H-622	Ⓑ Bonnet, chrome plated
3308853	H-541-ASD	Ⓒ Control Stop Repair Kit*

H-760 Stop, chrome plated: Screwdriver Straight Stop with H-573-A Locking Vandal Resistant Cap

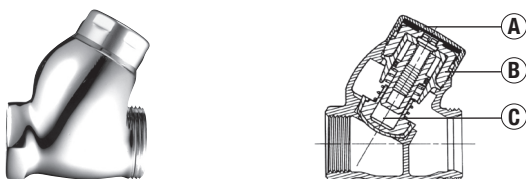

Complete Stops

0388023	H-760-AG	1" NPTF inlet for ground joint tail
---------	----------	-------------------------------------

Repair Parts

0308738	H-573-A	Ⓐ Locking Vandal Resistant Cap*, chrome plated
0308612	H-622	Ⓑ Bonnet, chrome plated
3308853	H-541-ASD	Ⓒ Control Stop Repair Kit*

*Refer to page 109 for diagrams of our Stop Caps and page 110 for the components supplied in our Control Stop Repair Kits.

Control Stop

CONTROL STOP AND REPLACEMENT PARTS

H-770 Stop, rough brass: Concealed Wheel Handle Straight Stop

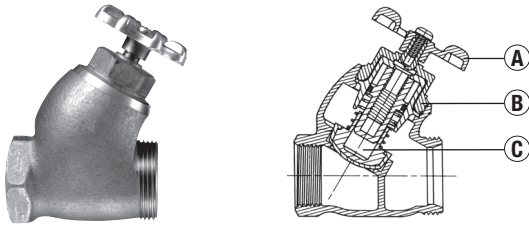

Complete Stops

0388030 H-770-AG 1" NPTF inlet for ground joint tail

Repair Parts

3308872 H-1011-A **A** Concealed Wheel Handle Repair Kit*

0208083 H-623 **B** Bonnet, rough brass

3308860 H-1006-A **C** Control Stop Repair Kit*

H-775 Stop, chrome plated: Exposed Wheel Handle Straight Stop

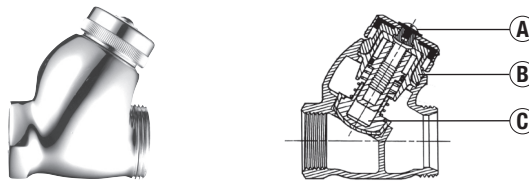

Complete Stops

0388036 H-775-AG 1" NPTF inlet for ground joint tail

Repair Parts

3308060 H-1002-A **A** Exposed Wheel Handle Repair Kit*

0308615 H-623 **B** Bonnet, chrome plated

3308855 H-541-AWH **C** Control Stop Repair Kit*

H-780 Stop, chrome plated: Screwdriver Straight Stop with H-37 Cap (Regal® Valve Stop) and H-795 Stop, chrome plated: Screwdriver Straight Stop with Vandal Resistant Cap (for Regal or Regal XL Valve Stop)

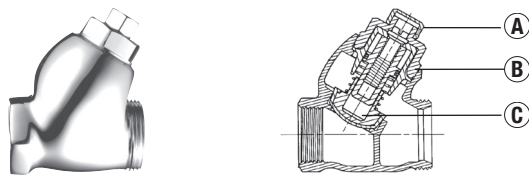

Complete Stops For Regal® flushometers

0388027 H-780-AG 1" NPTF inlet for ground joint tail – **DISCONTINUED**

Complete Stops For Regal® "XL" flushometers

0388079 H-795-AG 1" NPTF inlet for ground joint tail

Repair Parts

5388001 H-1012-A **A** Vandal Resistant Socket Cap*, chrome plated with set screw, for Regal "XL" flushometer – 6 per package

0308991 H-639 **B** Bonnet, chrome plated

3308853 H-541-ASD **C** Control Stop Repair Kit*

For H-790 Stop, refer to information shown for H-740 and H-790 Stops
For H-795 Stop, refer to information shown for H-780 and H-795 Stops

CONTROL STOP AND REPLACEMENT PARTS FOR H-540, H-600 AND H-700 SERIES CONTROL STOPS

Replacement Stop Caps for Screwdriver Control Stops for H-540, H-600, and H-700 Series Control Stops

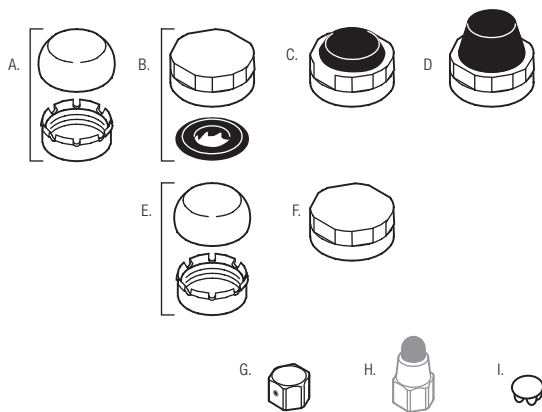

For 1" H-600 and H-700 Series Stops and 3/4" H-700 Series Stops

Item No.	Code No.	Part No.	Description
A.	3308772	H-1010-A	Vandal Resistant Stop Cap, chrome plated, with Sleeve
	5308954	H-628	Plastic Sleeve only – 6 per package
B.	3308840	H-573-A	Locking Vandal Resistant Stop Cap, chrome plated
C.	3308866	H-574	Stop Cap, chrome plated with Seat Bumper (-YO)
D.	3308867	H-576	Stop Cap, chrome plated with Extended Seat Bumper (-YG)

For 3/4" H-600 Series Stops

E.	3308790	H-1009-A	Vandal Resistant Stop Cap, chrome plated, with Sleeve and 3/4" Bonnet
	5308952	H-614	Plastic Sleeve only – 6 per package
F.	0308848	H-582	Stop Cap, chrome plated

For all H-40, H-440, H-540 and H-740 Series Stops

G.	5388001	H-1012-A	Vandal Resistant Stop Cap with set screw, chrome plated – 6 per package
H.	5310034	J-2/J-7	Stop Cap, chrome plated with Seat Bumper – 6 per package – DISCONTINUED
I.	5388002	H-528	Hole Plug

Control Stop

CONTROL STOP AND REPLACEMENT PARTS FOR H-540, H-600 AND H-700 SERIES CONTROL STOPS

Screwdriver Control Stop Repair Kits

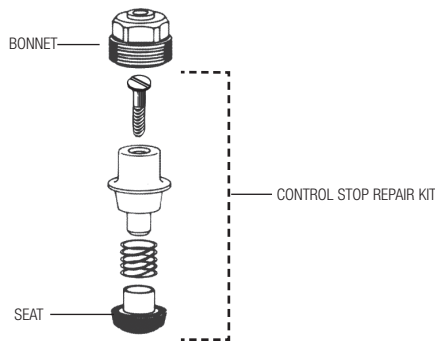

Code No.	Part No.	Description
Complete Repair Kits		
3308853	H-541-ASD	For 1" H-540, H-600 and H-700 Series Stops and 3/4" H-700 Series Stops
3308856	H-543-ASD	For 3/4" H-540 and H-600 Series Stops
Bonnets		
0308612	H-622	For 1" H-600 and H-700 Series Stops and 3/4" H-700 Series Stops
0308991	H-639	For 1" H-540 and H-740 Series Stops and 3/4" H-740 Series Stops
0308843	H-577	For 3/4" H-600 Series Stops – DISCONTINUED
0308601	H-538	For 3/4" H-540 Series Stops – DISCONTINUED
Seat only – 6 per package		
5308850	H-584	For 1" H-540, H-600 and H-700 Series Stops and 3/4" H-700 Series Stops
5308836	H-569	For 3/4" H-540 and H-600 Series Stops

Concealed Wheel Handle Control Stop Repair Kits – Note: Repair Kit includes H-1011-A Wheel Handle Repair Kit

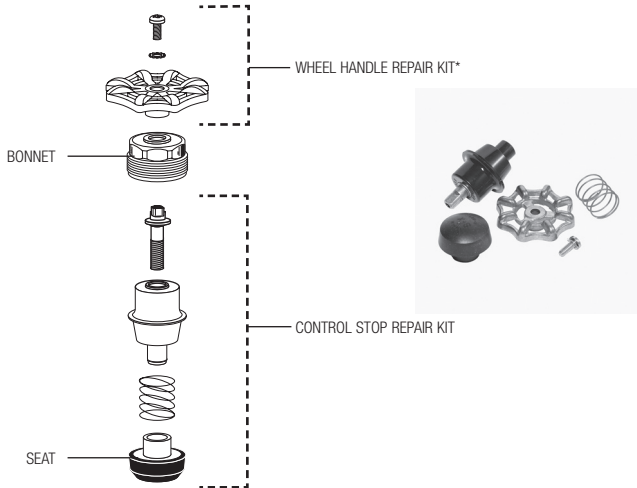

Complete Repair Kits		
3308860	H-1006-A	For 1" H-540, H-600 and H-700 WH Series Stops and 3/4" H-700 WH Series Stops
3308859	H-1007-A	For 3/4" H-540 and H-600 Series Stops
Wheel Handle Repair Kit — Note: Repair Kit includes handle, screw and lockwasher		
3308872	H-1011-A	For all Concealed Wheel Handle Stops
Bonnets		
0208083	H-623	For 1" H-540, H-600 and H-700 WH Series Stops and 3/4" H-700 Series Stops
0308705	H-561	For 3/4" H-540, H-600 Series Stops – DISCONTINUED
Seat only – 6 per package		
5308850	H-584	For 1" H-540, H-600 and H-700 WH Series Stops and 3/4" H-700 WH Series Stops
5308836	H-569	For 3/4" H-540 and H-600 Series Stops
NOTE: H-540 and H-600 Series concealed wheel handle stops made prior to 1993 featured a design identical to the exposed wheel handle design. These stops can be repaired using an exposed wheel handle repair kit or converted to the current design by using a concealed wheel handle repair kit.		

Exposed Wheel Handle Control Stop Repair Kits

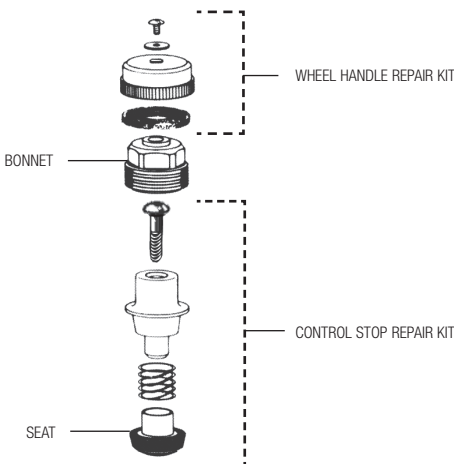









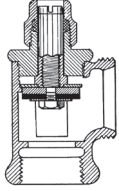

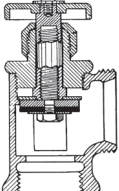
Complete Repair Kits		
3308855	H-541-AWH	For 1" H-540, H-600 and H-700 WH Series Stops and 3/4" H-700 Series Stops
3308858	H-543-AWH	For 3/4" H-540 and H-600 Series Stops
Wheel Handle Repair Kit — Note: Repair Kit includes handle, washer, screw and lockwasher		
3308060	H-1002-A	For all Exposed Wheel Handle Stops
5308059	H-1003-A	Screw and Lockwasher only – 12 per package
Bonnets		
0308615	H-623	For 1" H-540, H-600 and H-700 WH Series Stops and 3/4" H-700 Series Stops
0308705	H-561	For 3/4" H-540 and H-600 Series Stops DISCONTINUED
Seat only – 6 per package		
5308850	H-584	For 1" H-540, H-600 and H-700 WH Series Stops and 3/4" H-700 WH Series Stops
5308836	H-569	For 3/4" H-540 and H-600 Series Stops

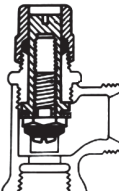
NOTE: 1" and 3/4" H-700 Series stops use "common stop" repair kits. 1" and 3/4" H-540 and H-600 Series stops use stop repair kits unique to each size. See the "common stop" on page 102 for more details.

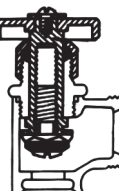
Control Stop

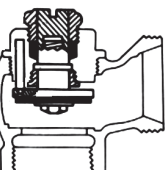
CONTROL STOP AND REPLACEMENT PARTS FOR OLDER CONTROL STOPS

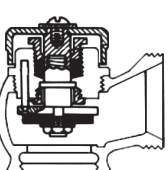
	Code No.	Part No.	Description
H-10-A 1" Screwdriver Angle Stop, (also fits H-15-A 1" Screwdriver Straight Stop) — used from 1920's through 1940's			
 	5308077	H-12	Packing only – 12 per package
	—	—	Bonnet no longer available
H-10-A 1" Wheel Handle Angle Stop (also fits H-15-A 1" Wheel Handle Straight Stop) — Used from 1920's through 1940's			
 	5308077	H-12	Packing only – 12 per package
	—	—	Bonnet no longer available
H-20-A 1/2" and 3/4" Screwdriver Angle Stop (also fits H-30-A Screwdriver Straight Stop) — Used from 1920's through 1950's			
 	5308077	H-12	Packing only – 12 per package
	—	—	Bonnet no longer available
H-20-A 1/2" and 3/4" Wheel Handle Angle Stop (also fits H-30-A Wheel Handle Straight Stop) — Used from 1920's through 1950's			
 	5308077	H-12	Packing only – 12 per package
	—	—	Bonnet no longer available
H-40-A 3/4" and 1" Screwdriver Angle Stop (also fits H-45-A Screwdriver Straight Stop) — Used from 1930's through 1960's			
 	3308277	H-47-A-SD	Repair kit includes packing ring, key socket, lock shield, retaining ring, screw assembly, and packing
	0308176	H-39-A-SD	Bonnet assembly repair kit includes a bonnet assembled with packing ring, key socket, retaining ring, screw assembly, and packing plus our H-37 Vandal Resistant Stop Cap that replaces the lock shield
	5308077	H-12	Packing only – 12 per package
	0308167	H-39	Bonnet Only
H-40-A 3/4" and 1" Wheel Handle Angle Stop (also fits H-45-A Wheel Handle Straight Stop) — Used from 1930's through 1960's			
 	3308278	H-47-A-WH	Repair kit includes packing ring, screw, wheel handle, key stem, gland for wheel handle, retaining gland, screw assembly, washer and packing
	0308175	H-39-A-WH	Bonnet assembly repair kit includes a bonnet assembled with packing ring, screw, wheel handle, key stem, gland for wheel handle, retaining gland, screw assembly, washer and packing
	5308077	H-12	Packing only – 12 per package
	0308170	H-39	Bonnet Only

NOTE: STOPS PRIOR TO 1964 WERE GROUND JOINT

Control Stop

CONTROL STOP AND REPLACEMENT PARTS

Code No.	Part No.	Description
----------	----------	-------------

H-340-A 3/4" and 1" Screwdriver and Wheel Handle Angle Stops — Used from 1940's through 1950's

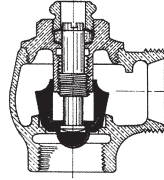

The only replacement part available for this stop is the rubber plug.

0308433	H-382-A	Rubber Plug
----------------	---------	-------------

H-440-A 3/4" Screwdriver Angle Stop — Used from 1950's through 1960's

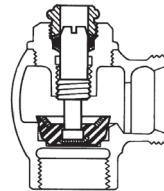

3308442	H-484-A-SD	Repair kit includes lock shield, packing, key stem, rubber plug, and packing ring
----------------	------------	---

0308432	H-439-AU	Bonnet assembly repair kit includes a bonnet assembled with packing, key stem, rubber plug, and packing ring plus our H-37 Vandal Resistant Stop Cap that replaces the lock shield
----------------	----------	--

0308434	H-439	Bonnet
----------------	-------	--------

0308490	H-484-A	Rubber Plug
----------------	---------	-------------

5308077	H-12	Packing only – 12 per package
----------------	------	-------------------------------

H-440-A 3/4" Wheel Handle Angle Stop — Used from 1950's through 1960's

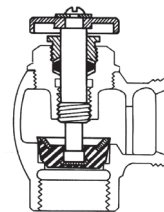

0308435	H-439	Bonnet
----------------	-------	--------

0308490	H-484-A	Rubber Plug
----------------	---------	-------------

5308077	H-12	Packing only – 12 per package
----------------	------	-------------------------------

H-440-A 1" Screwdriver Angle Stop (also fits H-445-A Screwdriver Straight Stop) — Used from 1950's through 1960's

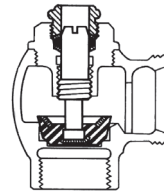

3308453	H-482-A-SD	Repair kit includes lock shield, packing, key stem, rubber plug, and packing ring
----------------	------------	---

0308428	H-439-A	Bonnet assembly repair kit includes a bonnet assembled with packing ring, key socket, retaining ring, screw assembly, and packing plus our H-37 Vandal Resistant Stop Cap that replaces the lock shield
----------------	---------	---

0308434	H-439	Bonnet
----------------	-------	--------

0308489	H-482-A	Rubber Plug
----------------	---------	-------------

5308077	H-12	Packing only – 12 per package
----------------	------	-------------------------------

H-440-A 1" Wheel Handle Angle Stop (also fits H-445-A Wheel Handle Straight Stop) — Used from 1950's through 1960's

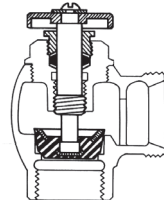

0308435	H-439	Bonnet
----------------	-------	--------

0308489	H-482-A	Rubber Plug
----------------	---------	-------------

5308077	H-12	Packing only – 12 per package
----------------	------	-------------------------------

NOTE: H-440 Series control stops were used with Sloan's "Quiet Flush" flushometer models.

NOTE: All obsolete control stops are for ground joint tailpiece connections.

NOTE: Sloan has made other stops up to 1964. If you have an older stop that is not listed on these two pages, the repair parts are obsolete. Prior to 1964, all stops were ground joint connections; the H-700-AG series stops, 3/4" and 1" angle stops, and 1" straight stops, are the current replacement.

Control Stop

THE "COMMON STOP"

In 1996, Sloan began using the H-700 series of control stops with all flushometers. This "common stop" offers 3/4" and 1" supply inlet size options, yet uses a single repair kit for both urinal and water closet stops. This change primarily affects the H-700 series 3/4" stops, which now use the same repair kit as 1" stops. Repair kits for the smaller H-540 and H-600 3/4" stops remain available and are included in this section.

The "common stop" body offers precise control over flow rates delivered through the valve. This feature is important, especially for 1-gallon urinal designs. This finite flow adjustment makes the difference between a proper flush and an ineffective flush that splashes and spills.

The "common stop" internal components are interchangeable with their counterparts in older H-600 and H-540 stops. The distinctively contoured seat plug in the "common stop" allows a finer flow rate adjustment similar to that of a needle valve. Unlike natural rubber components that can be destroyed by water treatment products, our synthetic Permex™ rubber seat plugs resist the effects of chloramines. Our stop spring, formerly brass, is now constructed of stainless steel. This helps prevent corrosion from the increasingly aggressive water supplies we see today.

All complete "common stops" now have bonnets stamped with an H-700 series number. Both exposed and concealed wheel handle stops are stamped H-700-WH series. The H-740 and H-780 stops that replace the H-540 series stops used with Regal valves are stamped H-740 series.

CONTROL STOP DESIGNS

Supply Inlets

Sloan supplies control stops in two basic inlet sizes:

1. 3/4" NPTF — For most urinal flushometers
2. 1" NPTF — For all water closet flushometers and blow-out urinal flushometers

Control stops are also available in some models with the following inlets for specialized and export applications:

1. 1" Whitworth thread
2. 1" BSP British Standard Pipe inlet
3. 1" NSPM Straight thread — for use with shipboard Sil-Braz fittings

Tailpiece Connections

The majority of flushometers supplied by Sloan since 1964 feature an adjustable tailpiece. Connection of the valve tailpiece to the control stop is made with a sliding O-ring seal.

Older valves (produced before 1964), and valves furnished for salt-water installations, and all straight stops utilized a metal-to-metal ground joint (G.J) connection.

When replacing an older stop, it is important to note which type of stop connection is required.

Stops for use with salt water must be made from Naval brass.

GENERAL INSTALLATION INSTRUCTIONS

Install the Sloan Bak-Chek® control stop to water supply line with outlet positioned as required. Tighten the control stop coupling with a wrench.

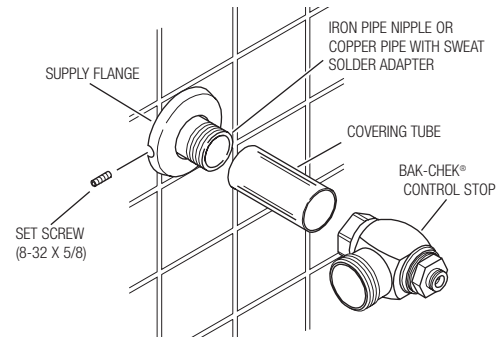

CONTROL STOP ADJUSTMENT

After installation or service, readjust the control stop to meet the flow rate required for the proper cleansing of the fixture. Open the control stop COUNTERCLOCKWISE one full turn from the closed position. Activate flushometer.

Adjust control stop after each flush until the rate of flow delivered properly cleanses the fixture. Turn the control stop adjustment screw (or wheel handle) COUNTERCLOCKWISE to increase the flow rate or CLOCKWISE to decrease the flow rate.

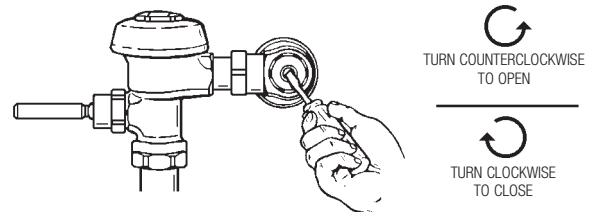

Important: A Sloan flushometer is engineered for quiet operation. Excessive water flow creates noise, while too little water flow may not satisfy the needs of the fixture. Proper adjustment is made when the plumbing fixture is cleansed after each flush without splashing water out from the lip AND a quiet flushing cycle is achieved.

The control stop should never be opened to the point where the flow from the valve exceeds the flow capability of the fixture. In the event of a valve failure, the fixture must be able to accommodate a continuous flow from the valve.

MAINTENANCE AND CLEANING

Control stops have moving parts that may wear over time. Deterioration of rubber parts may result in an incomplete seal. If you can not shut off the stop completely, or if leakage is visible at the adjustment screw, order one of our control stop repair kits and rebuild the control stop.

DO NOT USE abrasive or chemical cleaners to clean flushometers. These cleaners may dull the luster and attack the chrome or special decorative finishes. Use **ONLY** mild soap and water, and then wipe dry with a clean cloth or towel. While cleaning the bathroom tile, protect the flushometer from any splattering of cleaner. Acids and cleaning fluids can discolor or remove chrome plating.