

Concealed SOLIS® Flushometer

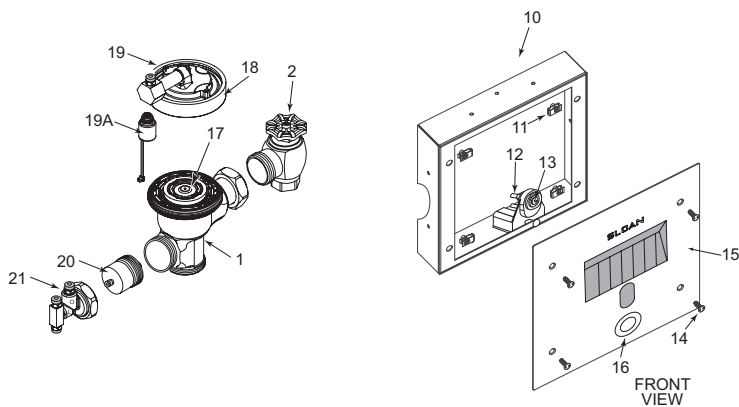

SOLIS 8152 SWB

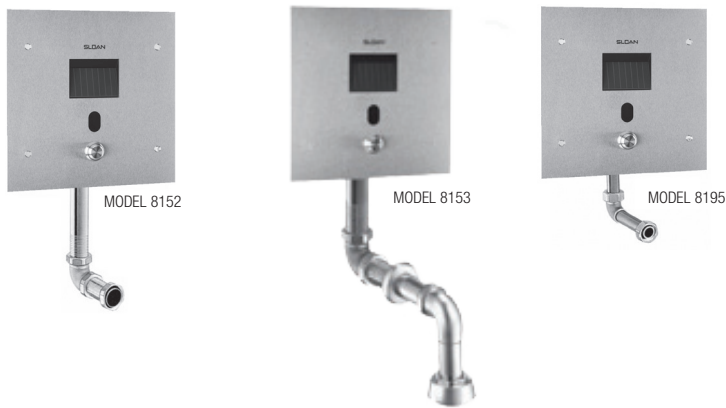
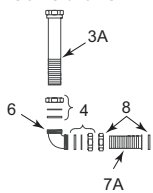

SOLIS 8153 SWB

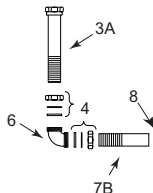

SOLIS 8195 SWB

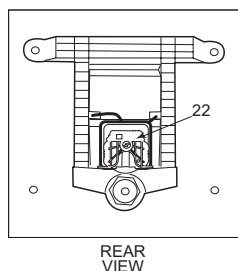
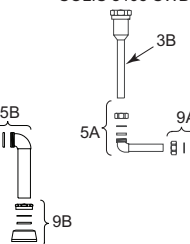

PARTS LIST

Item No.	Code No.	Part No.	Description
1.	0301050	A-143-A	RB Hydraulic Valve Body
2.	0388010	H-730-A	RB Bak-Chek® 1" Control Stop
	0388011	H-730-A	RB Bak-Chek® 3/4" Control Stop
3A.	‡	V-500-AA	1-1/2" (38 mm) Vacuum Breaker Assembly RB (Model 8152)
3B.	‡	V-500-AA	3/4" (19 mm) Vacuum Breaker Assembly RB (Model 8195)
4.	0306619	F-2-AA	1-1/2" (38 mm) Slip Joint Coupling RB (Set of Two)
5A.	‡	F-15-A	ELL with 3/4" (19 mm) Tail RB (Model 8195)
5B.		F-15-A	ELL with 1 1/2" (19 mm) Tail RB (Model 8153)
6.	0206146PK	F-21	1-1/2" (38 mm) Double Male Slip Elbow
7A.	‡	F-100	1-1/2" (38 mm) Outlet Tube RB
7B.	‡	F-102	1-1/2" (38 mm) Outlet Tube CP
8.	0306091	F-2-A	1-1/2" (38 mm) Coupling with S-21 Gasket
9A.	0306054	F-2-AW	3/4" (19 mm) Slip Joint Coupling RB
9B.	‡	F-5-A	1-1/2" (38 mm) Spud Coupling Assembly CP
10.	3325215	‡	Wall Box Frame Assembly (includes 11, 12 & 13)
11.	0334017PK	WB-18	U-Type Nuts (4)
12.	33753009	WB-1002A	Override Holder Repair Kit
13.	0318123	HY-71A	RB Hydraulic Override Button Assembly
14.	0334024PK	WB-49	1/4"-20 x 1 1/2" Tamper Resistant Screws (1 each)
15.	‡	‡	Wall Plate Assembly
16.	3334001	WB-1001-A	SS Override Button Assembly
17.	‡	‡	Diaphragm [†] (refer to table & diaphragm on following page)
18.	0325355	EBV-355-A	Cover Assembly (includes item 19)
19.	0325804PK	EBV-14	Coupling
19A.	0325356	EBV-356-A	Solenoid
20.	3318026	HY-1005-A	Actuator Cartridge
21.	0318195	HY-128-A1	Actuator Assembly
	—	HY-30-84	1/4" (6 mm) x 84" (2134 mm) Connecting Tubes (not shown)
	—	HY-30-24	1/4" (6 mm) x 24" (610 mm) Connecting Tubes (not shown)
22.	3325166	EBV-366AU	0.5 gpf Sensor Assembly
	3325167	EBV-367AU	1.0 gpf Sensor Assembly
	3325168	EBV-368AC	1.28 gpf Sensor Assembly
	3325169	EBV-369 AC	1.6 gpf Sensor Assembly

[†] Flow volume varies with valve model and desired flush volume. Refer to table and diaphragm on following page.
[‡] Code and/or Part number varies with valve model variation; consult factory.

ITEM 4A. SLIP JOINT GASKETS AND RINGS

Size	Code No.	Part No.	Description
1-1/2"	5306058	F-3	Red Friction Ring
	5322001	VBF-5	Black Slip Joint Gasket
	0319086/5319086	S-30	Flexible Seat
	0319079	S-21	Rigid Seat (rubber over brass)
1-1/2" x 1-1/4"	0396062	F-105	Slip Joint Gasket – Rigid
1-1/4"	5306057	F-3	Red Friction Ring
	5322176	VBF-5	Black Slip Joint Gasket
	0307052/5307052	G-21	Rigid Seat (rubber over brass)
1"	5306056	F-3	Red Friction Ring
	5306115	F-5	Black Slip Joint Gasket
3/4"	5306055	F-3	Red Friction Ring
	5306113	F-5	Black Slip Joint Gasket

Concealed SOLIS® Flushometer



DUAL-FILTERED DIAPHRAGM ASSEMBLY

Available in diaphragm only and Royal® Performance™ Kits.

Royal® Performance™ Kit includes dual-filtered diaphragm assembly (item 3), handle repair kit with triple seal packing (item 8), high back pressure vacuum breaker repair kit (item 11), and one tailpiece O-ring (item 15A). DIAPHRAGM ONLY KIT contains “drop-in” dual-filtered diaphragm assembly (item 3) ONLY.

The dual-filtered diaphragm can be used in Royal®, Regal®, and similar diaphragm-style valve bodies. For use in Sloan valve bodies with a bell-shaped cover (manufactured before 1964), replace the bottom filter ring in these kits with a blue A-108 filter ring (not shown Sloan Code No. **5301283**).

NOTE: In January 1998, the Royal® diaphragm design was upgraded to a preassembled unit with two (2) plastic filtering rings attached to the rubber diaphragm (one on top and one on bottom). If the flushometer you are servicing has our older, segmented diaphragm with brass by-pass hole, refer to our Regal section for additional troubleshooting information.

ROYAL® HYDRAULIC PERFORMANCE KIT (Includes Dual-Filtered Diaphragm Assembly, HY83A Hydraulic Actuator Cartridge, H553 Tailpiece O-ring, and V651A High Back Pressure Vacuum Breaker Kit)

Code No.	Part No.	Description	Relief Valve†	Refill Head*	Flow Ring
3318011	HY-1101-A	Hydraulic Performance Kit Closet-1.6 gpf (6.0 Lpf)**	Green	Gray	Smooth
3318012	HY-1102-A	Hydraulic Performance Kit Closet-3.5 gpf (13.2 Lpf)**	White	Gray	Smooth
3318013	HY-1103-A	Hydraulic Performance Kit Closet-2.4 gpf (9.0 Lpf)	Blue	Gray	Smooth
3318014	HY-1106-A	Hydraulic Performance Kit Urinal-0.5 gpf (1.9 Lpf)	Green	Black	Slotted
3318015	HY-1107-A	Hydraulic Performance Kit Urinal -1.0 gpf (3.8 Lpf)**	Green	Black	Slotted
3318016	HY-1108-A	Hydraulic Performance Kit Urinal-1.5 gpf (5.7 Lpf)**	Black	Black	Smooth

*CLOSET REFILL HEADS (GRAY) HAVE LARGER SLOTS THAN URINAL REFILL HEADS (BLACK).

DIAPHRAGM ONLY KIT

Code No.	Part No.	Description	Relief Valve†	Refill Head*	Flow Ring
3301502	A-1041-A	Low Consumption Water Closets-1.6 gpf (6.0 Lpf)**	Green	Gray	Smooth
3301501	A-1038-A	Water Saver Water Closets-3.5 gpf (13.2 Lpf)**	White	Gray	Smooth
3301505	A-1044-A	9 Liter European Water Closets-2.4 gpf (9.0 Lpf)	Blue	Gray	Smooth
3301504	A-1043-A	Wash Down Urinals-0.5 gpf (1.9 Lpf)	Green	Black	Slotted
3301503	A-1042-A	Low Consumption Urinals-1.0 gpf (3.8 Lpf)**	Green	Black	Slotted
3301500	A-1037-A	Water Saver Urinals-1.5 gpf (5.7 Lpf)**	Black	Black	Smooth
3301506	A-1045-A	High-Efficiency Water Closets-1.28 gpf (4.8 Lpf)	Blue	Gray	Smooth
3301142	A-1047-A	High-Efficiency Urinals-0.25 gpf (1.0 Lpf) with White Inserts	White	HEU Black	Smooth
3301143	A-1050-A	High-Efficiency Urinals-0.125 gpf (0.5 Lpf) with White Inserts	Blue	HEU Black	Smooth
3301594	A-1075-A-BX	High-Efficiency Water Closets-1.28 gpf (4.8 Lpf) RW	Blue	Black	Smooth
3301592	A-1073-A-BX	High-Efficiency Urinals-0.5 gpf (1.9 Lpf) RW + Slotted	Green	Black	Smooth
3301591	A-1077-A-BX	High-Efficiency Urinals-0.25 gpf (1.0 Lpf) RW	White	HEU Black	Smooth
3301590	A-1070-A-BX	High-Efficiency Urinals-0.125 gpf (0.5 Lpf) RW	Blue	HEU Black	Smooth

† Consult factory for availability of replacement plastic relief valves (green, black, blue, and white) and brass relief valves.

NOTE: For older water closets that require 4.5 gpf (17.0 Lpf), choose kits A-1102-A or A-1038-A, but remove the flow ring before use. For blowout-style urinals that require 3.5 gpf (13.2 Lpf), choose kits A-1102-A or A-1038-A. For service sinks that require 6.5 gpf (24.6 Lpf), order A-36-A diaphragm repair kit (not shown Sloan Code No. **3301036**) and remove the flow ring before use. Regulations for low consumption fixtures prohibit the use of higher flush volumes.

*CLOSET REFILL HEADS (GRAY) HAVE LARGER SLOTS THAN URINAL REFILL HEADS (BLACK).

** WATER SAVER (3.5 GPF CLOSET AND 1.5 GPF URINAL) AND LOW CONSUMPTION (1.6 GPF CLOSET AND 1.0 GPF URINAL) FIXTURES MUST USE MATCHING GPF (LPF) DIAPHRAGM KITS; USING A SMALLER GPF (LPF) KIT IN FIXTURES NOT INTENDED FOR LESS VOLUME WILL RESULT IN INADEQUATE DILUTION IN URINALS AND IMPROPER EVACUATION IN CLOSETS. RW for use with Reclaimed Water Flushometers.

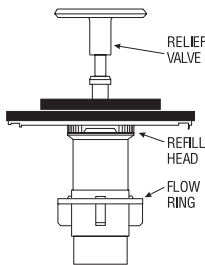

THE COLORS OF THE RELIEF VALVE AND THE REFILL HEAD PLUS THE SHAPE OF FLOW RING IDENTIFY THE FLUSH VOLUME OF A DUAL-FILTERED DIAPHRAGM ASSEMBLY.

Concealed SOLIS® Flushometer

TROUBLESHOOTING GUIDE

NOTE: Upon detection of the user, the red indicator light flashes slowly, during start-up (first 10 minutes). After a period of eight seconds unit is ready to flush. When the user leaves the detection range, the sensor initiates the flush sequence. Then the indicator light stops flashing and the valve flushes. The valve will flush after a three-second (water closets) or one-second (urinals) delay.

1. Sensor flashes continuously only when user steps within range.

- A. Unit in start-up mode; no problem. This feature is active for the first ten (10) minutes of operation.

2. Valve DOES NOT flush; sensor does not picking up user.

- A. Range too short; increase the range. Consult factory.

3. Valve DOES NOT flush; sensor picking up opposite wall or surface, or only flushes when someone walks by. Light flashes continuously for first 10 minutes even with no one in front of the sensor.

- A. Range too long; shorten range. Consult factory.

4. Valve DOES NOT flush even after adjustment.

- A. Batteries completely used up; replace batteries.
- B. Problem with electronic sensor module; replace electronic sensor module.
- C. Problem with solenoid; replace solenoid.

5. Unit flashes a sequence of 4 quick times when user steps within range.

- A. Batteries low; replace batteries.

6. Valve DOES NOT shut off.

- A. Bypass orifice in diaphragm is clogged with dirt or debris, or bypass is clogged by an invisible gelatinous film due to "over-treated" water. Remove diaphragm and wash under running water. **NOTE:** Size of orifice in the bypass is of utmost importance for the proper metering of water by the valve. **DO NOT ENLARGE OR DAMAGE THIS ORIFICE.** Replace diaphragm if cleaning does not correct the problem.
- B. Dirt or debris fouling relief valve or diaphragm. Remove diaphragm and wash under running water.
- C. Problem with electronic sensor module; replace sensor module.

7. Not enough water to fixture.

- A. Wrong relief valve installed in diaphragm kit. Install the correct relief valve.
- B. Wrong SOLIS® model installed; i.e., 1.0 gpf urinal installed on 3.5 gpf closet fixture. Replace with proper SOLIS model.
- C. Enlarged bypass in diaphragm. Replace diaphragm.
- D. Control stop not adjusted properly. Readjust control stop.
- E. Inadequate volume or pressure at supply. Increase water pressure or supply (flow) to valve. Consult factory for assistance.

8. Too much water to fixture.

- A. Wrong relief valve installed in diaphragm kit. Install the correct relief valve.
- B. Control stop not adjusted properly. Readjust control stop.
- C. Wrong SOLIS model installed; i.e., 1.6 gpf model installed on 1.0 or 1.5 gpf urinal fixture. Replace with proper SOLIS model.
- D. Dirt in diaphragm bypass. Clean under running water or replace diaphragm.

PUSH BUTTON ACTUATOR

9. Leakage occurring at the push button.

- A. Damage or worn seals or lime build-up in the actuator cartridge. Replace with new cartridge.

10. The flushometer DOES NOT flush and a small amount of leakage is visible below the valve.

- A. Foreign material lodged in the cartridge. Remove the cartridge and inspect for foreign material. Clean under running water.
- B. Damaged or worn seals or lime build-up in the actuator cartridge. Replace with new cartridge.
- C. Plastic tubing installed incorrectly. Match tubing ends from valve body actuator to button actuator, so that "L" to "L" and "O" to "O".

FLUSHOMETER ACTUATOR ASSEMBLY

11. The flushometer DOES NOT flush or flushes only once and will not flush a second time when the button is pushed.

- A. The plunger is lodged in the actuator cartridge or the plunger bypass hole is clogged. Remove the actuator housing & cartridge from the flushometer. Clean under running water. If cartridge parts are worn, deteriorated or limed up & problem persists after cleaning, replace with new cartridge.
- B. Plastic tubing installed incorrectly. Match tubing ends from valve body actuator to button actuator, so that "L" to "L" and "O" to "O".

TO REMOVE THE ACTUATOR FROM THE FLUSHOMETER

- A. Turn off water from control stop.
- B. Unscrew the housing coupling nut from the flushometer.
- C. Remove the actuator housing from the flushometer. The tubing connections can be left intact.
- D. Remove the actuator cartridge from the flushometer body. Care should be taken so that upon removal the actuator and the o-ring do not separate due to spring compression within. If the actuator cartridge is lodged in the body cavity, grip the exposed portion gently with a pair of channel-lock pliers and rotate back and forth to loosen the o-ring seal.
- E. Separate the actuator housing to reveal the spring and plunger.

!!! IMPORTANT — CONTROL STOP SETTING !!!

NEVER OPEN CONTROL STOP TO WHERE THE FLOW FROM THE VALVE EXCEEDS THE FLOW CAPABILITY OF THE FIXTURE. IN THE EVENT OF A VALVE FAILURE, THE FIXTURE MUST BE ABLE TO ACCOMMODATE A CONTINUOUS FLOW FROM THE VALVE.

THIS PRODUCT CONTAINS MECHANICAL AND/OR ELECTRICAL COMPONENTS THAT ARE SUBJECT TO NORMAL WEAR. THESE COMPONENTS SHOULD BE CHECKED ON A REGULAR BASIS AND REPLACED AS NEEDED TO MAINTAIN THE VALVE'S PERFORMANCE.

LAWS AND REGULATIONS PROHIBIT THE USE OF HIGHER FLUSHING VOLUMES THAN LISTED ON FIXTURE OR FLUSHOMETER.

DO NOT USE TOOTHED TOOLS TO INSTALL OR SERVICE THESE VALVES. USE A SLOAN A-50 SUPER WRENCH, SLOAN A-109 PLIER WRENCH OR SMOOTH JAWED WRENCH TO SECURE ALL COUPLINGS.

CARE AND CLEANING INSTRUCTIONS

DO NOT USE abrasive or chemical cleaners to clean flushometers that may dull the luster and attack the finish. Use **ONLY** mild soap and water, then wipe dry with a clean towel or cloth. When cleaning the bathroom tile, protect the flushometer from any splattering of cleaner. Acids and cleaning fluids can discolor or remove finish.

**When assistance is required, please contact
Sloan Technical Support at: 1-888-SLOAN-14 (1-888-756-2614).**