

SERVER

• E S S E N T I A L S •

Fudge Server

MODEL: FS
120V USA

COMPLETE BASE ONLY
82500 82066

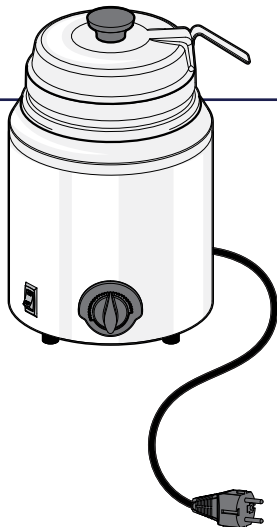

Fudge Server with Pump

MODEL: FSP
120V USA
230V CONT. EUROPE
230V CUSTOM
230V UNITED KINGDOM

COMPLETE BASE ONLY
82060 82066
82110
81003
84580

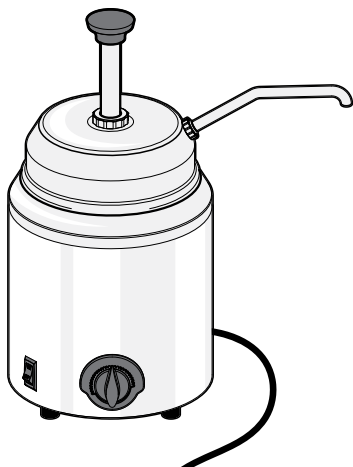

Thank You

for purchasing our topping warmer.
Its temperature sensing thermostat helps reduce food
costs while delivering a superior product.

SERVE BETTER WITH DISTINCTIVE DESSERTS

SAFETY



WARNING-

ELECTRICAL SHOCK COULD OCCUR

This unit must be earthed or grounded.

This requires all three prongs (terminals) on cord plug to be plugged into power source.

According to food and safety regulations, most foods must be stored and/or served at certain temperatures or they could become hazardous. Check with local food and safety regulators for specific guidelines.

Be aware of the product you are serving and the temperature the product is required to maintain. Server Products, Inc. can not be responsible for the serving of potentially hazardous product.



PARTS

PARTS MAY VARY DEPENDING ON UNIT

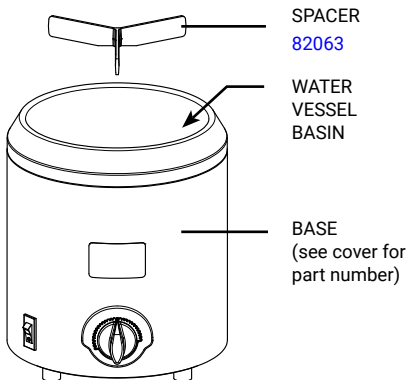
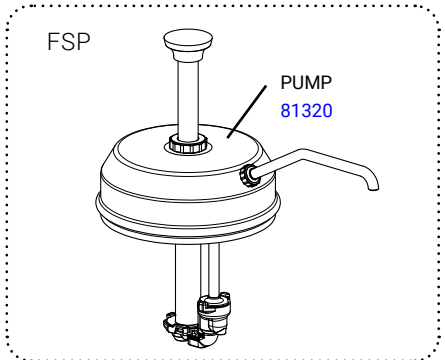
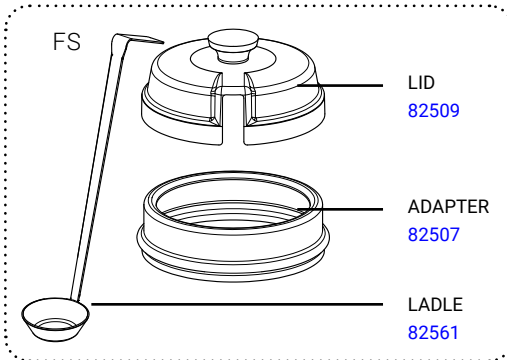

UNIT SET-UP

WASH ALL PARTS PROPERLY BEFORE EVERY USE. See page 6.
SEE SEPARATE PUMP MANUAL FOR PUMP INSTRUCTIONS.

1 FILL WATER VESSEL BASIN

- Fill 2.5 cups (20 oz/0.59 liter) of water up to water level line inside basin.
- Do not overfill.

TIP: Check water levels throughout the holding period to ensure even heating. Filtered water is recommended to deter corrosion.

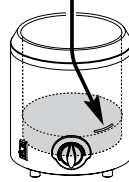

2 INSERT SPACER

3 PUT FOOD CONTAINER INTO WATER VESSEL BASIN

- Product being served must be inside #10 can or stainless steel jar.
- Never place food directly into water vessel basin of unit.**

TIP: Simplify change-outs with a stainless steel jar. Order item #94009.

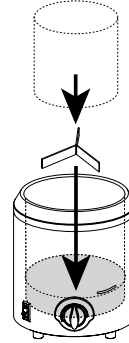

4 INSTALL LID ACCESSORIES OR PUMP

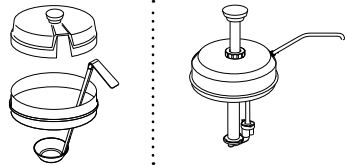

5 PLUG CORD into power source.

6 PRESS SWITCH to the "ON" position.

7 SET THERMOSTAT KNOB

- to recommended serving temperature.
- Pull knob out to turn and adjust.
- Push knob in to lock.
- Dial indicator uses increments of 5°F.
- Thermostat range is 75°–210° F. (24°–99° C)
- To heat unit faster, thermostat may TEMPORARILY be rotated to maximum.

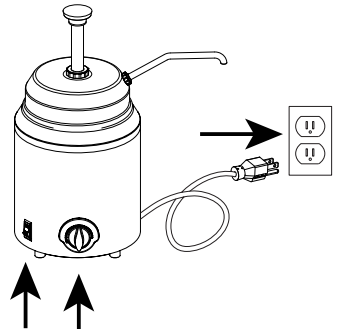

REHERMALIZATION

Rethermalization of food products is achieved by this appliance when it elevates the food product temperature from a refrigerated 40°F (4°C) to a safe serving temperature of 165°F (74°C) within a period of 2 hours.

1 PRE-HEAT UNIT

for at least 5 minutes with:

- Correct amount of water in basin.
- Lid closed.
- Thermostat knob set at maximum setting.

2 ADD FOOD PRODUCT

- Put food container into the water vessel basin.
- Maximum capacity of food product is 3 quarts (96 oz./12 cups). Do not overfill.

3 MAINTAIN SAFE HOT FOOD HOLDING

- After food reaches safe serving temperature of 165°F (74°C), maintain product temperature at or above 150°F (66°C).
- Adjust controller if needed to avoid overheating food.

HOT FOOD HOLDING

Hot Food Holding is achieved with this appliance when it maintains a food product temperature at or above 150°F (66°C), in all locations throughout the product, for a minimum of 2 hours, even if any lid, cover, or pump is removed. The lid, cover, or pump is recommended to help maintain product temperature.

1 PRE-HEAT UNIT

for at least 5 minutes with:

- Correct amount of water in basin.
- Lid closed.
- Thermostat knob set at maximum setting.

2 ADD FOOD PRODUCT

- Put food which has already been preheated to 150°F (66°C) into container in water vessel basin.
- Maximum capacity of food product is 3 quarts (96 oz./12 cups). Do not overfill.

MONITOR FOOD CLOSELY FOR FOOD SAFETY.

The United States Public Health Service recommends that hot food be held at a minimum of 140°F (60°C) to help prevent bacteria growth.

COLD FOOD IS NOT TO BE ADDED TO THE UNIT FOR REHERMALIZATION WHILE HOT FOOD IS BEING HELD.



NSF International and ANSI (American National Standards Institute) list this unit as a "Rethermalization and Hot Food Holding unit (Standard 4)."

SMART TIP

ALWAYS USE SPACER BENEATH FOOD CONTAINER

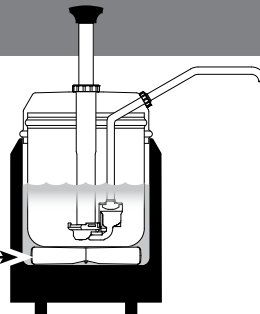
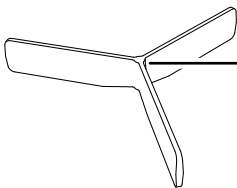

WITH SPACER

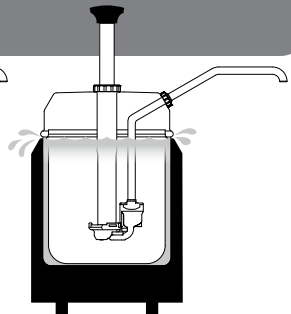

WITHOUT SPACER

Food may overheat from resting on the bottom.

Water may overflow into food container.

Excess product may be left in food container.

UNIT TAKE-DOWN

SEE SEPARATE PUMP MANUAL FOR PUMP INSTRUCTIONS.

1 PRESS SWITCH to the "OFF" position.

2 UNPLUG CORD



CAUTION- HOT
Allow unit to cool before continuing.

3 REMOVE PUMP OR LID

4 REMOVE FOOD CONTAINER & SPACER

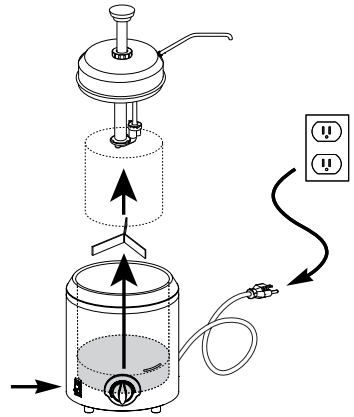

5 EMPTY WATER FROM WATER VESSEL BASIN after each use.

TIP: Remember to **empty** the water each day rather than **add**—

This will greatly extend the life of your warmer.

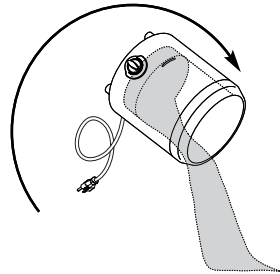

6 DRY thoroughly with a soft dry cloth.

Proper drying after each use helps maintain the stainless steel.

CLEANING



SEE SEPARATE PUMP MANUAL FOR PUMP INSTRUCTIONS.

WARNING- **ELECTRICAL SHOCK COULD OCCUR**

- Electrical components of unit could be damaged from water exposure or any liquid.
- Never immerse unit into water or any liquid.
- Never use any water jet or pressure sprayer on unit.
- Ensure unit is "OFF" and unplugged.

CAUTION- HOT

Allow unit to cool before cleaning.



- 1** **WASH REMOVABLE PARTS**
 - Before first use and after use daily, disassemble and clean unit.
 - Ensure unit is "OFF" and unplugged.
 - Wash with dishwashing soap and hot water.
- 2** **RINSE** fully with clear water.
- 3** **SANITIZE** all parts according to local sanitization requirements. All parts in contact with food must be sanitized.
- 4** **DRY** all parts fully with a clean soft cloth.
- 5** **CLEAN EXTERNAL SURFACES**
 - Wipe daily with a clean damp cloth.
 - Dry with a clean soft cloth.
 - Glass and surface cleaners approved for use in food contact areas may be used.

CARE OF STAINLESS STEEL

This warmer and accessories are constructed of stainless steel— one of the best materials for food serving and storage.

If you notice corrosion beginning on any stainless steel surface, you may need to change the cleansing agent, sanitizing agent, or the cleaning procedures you are using.

- A mildly abrasive nylon or brass brush may be used to remove any stubborn food or mineral deposits on interior surfaces of unit.
- Fully rinsing and drying all parts can help prevent corrosion. Elements and minerals in tap water can accumulate on stainless steel parts and create corrosion.
- Do not use abrasive, caustic or ammonia based cleansers.
- Do not use products containing acids, alkalines, chlorine, or salt. These agents can corrode stainless steel.
- Do not use metal scrapers or cleaning pads that could scratch surfaces.

WIRING

UNIT [82066](#) | 120V | USA

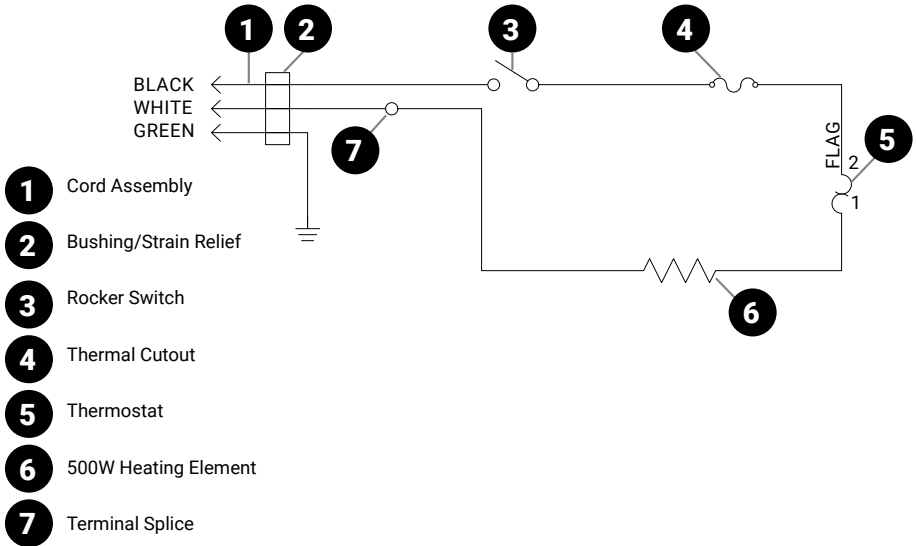

UNITS [82110](#), [81003](#), [84580](#) | 230V | CONT. EUROPE, AU, UK

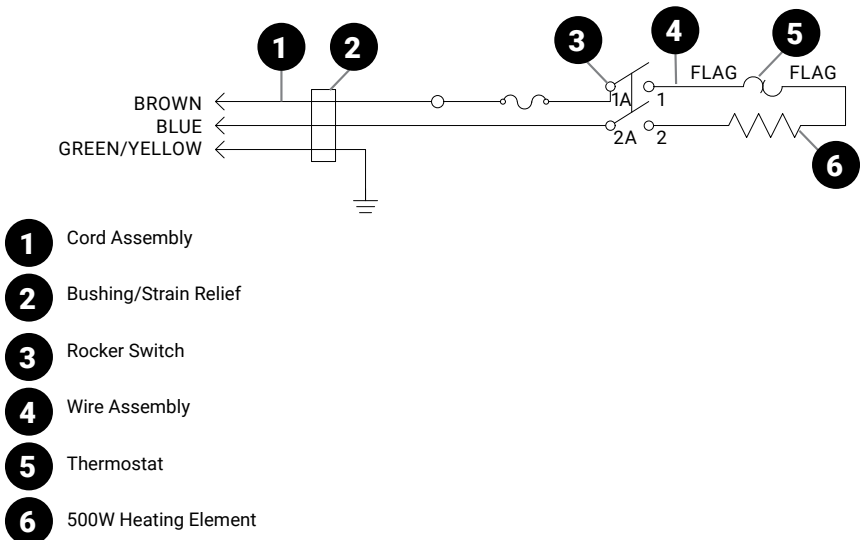

TROUBLESHOOTING

UNIT DOES NOT HEAT?

- Ensure cord is securely plugged in.
- Ensure power is available from source.
- Ensure unit is on.
- Ensure thermostat knob is set correctly.
- Ensure that the correct amount of water is in basin.
- Do not allow any of the electrical components to get wet. Moisture may cause the unit to trip breaker or GCFI. If moisture is suspected, discontinue use. Allow unit to fully air dry.

PREVENT PITTING ON INSIDE SURFACE OF VESSEL

- Empty water from water vessel basin each day.
- Thoroughly dry basin each day.
- If possible, use filtered water to fill vessel basin.

SERVER PRODUCTS LIMITED WARRANTY

2 YEAR
WARRANTY

This Server product is backed by a two-year limited warranty against defects in materials and workmanship. See [Server-Products.com](https://www.server-products.com) for details.

GENERAL SERVICE, REPAIR OR RETURNS

Before sending any item to Server Products for service, repair, or return, contact Server Products customer service to request a **Return Authorization Number**. Merchandise must be sent to Server Products with this number. Service is extremely prompt. Typically, units are repaired and ship out within 48 hours of receipt.

Merchandise being returned for credit must be in new and unused condition and not more than 90 days old and will be subject to a 20% restocking charge. Electrical parts (thermostats, heating elements, etc.) are not returnable.

Servicing Cord: Specific tools are required for safe and proper power supply cord removal and installation. If cord must be replaced, only a representative of the OEM (original equipment manufacturer) or a qualified technician may replace cord. Cord must meet code designation H05 RN-F requirements.

NEED HELP?

Server Products Inc.

3601 Pleasant Hill Road
Richfield, WI 53076 USA

Chat with us!

spsales@server-products.com

262.628.5600 | 800.558.8722

Please be prepared with your **Model, P/N** and **Series** located on the lid or base of the unit.

Example:

MODEL XXXX P/N #####		SERIES ##X ##X
-------------------------------	---	-------------------

SERVER
INTELLIGENT BY DESIGN