



S E R V E R

SERVE BETTER™

EZ-Topper™ Tall, Single

MODEL: EZT-S

85718 COMPLETE
85850 WARMER BASE

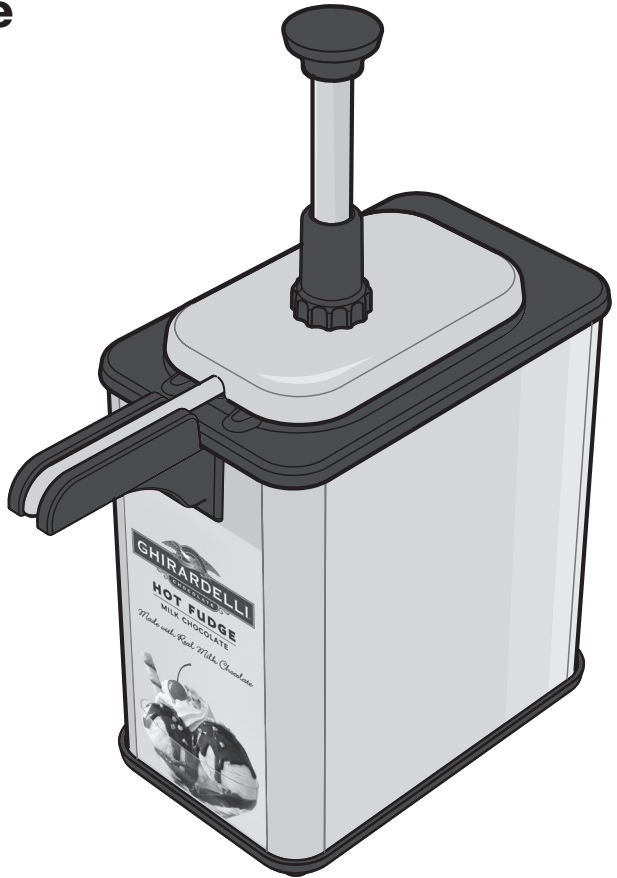

Used with
48 fl. oz pouches
with 16mm
center fitments.

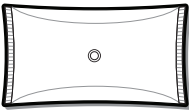

Thank You

...for your purchase. This pouched topping warmer virtually eliminates product degradation and waste, so you can reduce food costs while delivering a superior product.

SIMPLIFY TOPPING MANAGEMENT — GO POUCHED

PARTS

EZ-TOPPER PUMP
85820-400

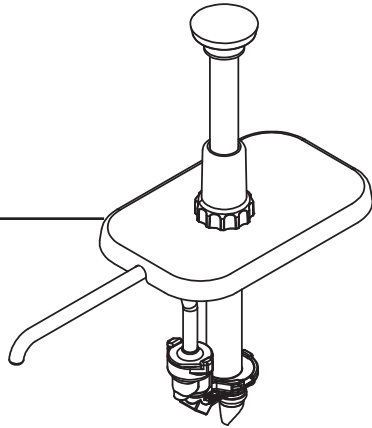

POUCH SUPPORT
85819

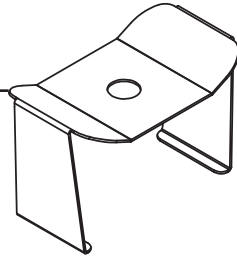

WARMER BASE
85850

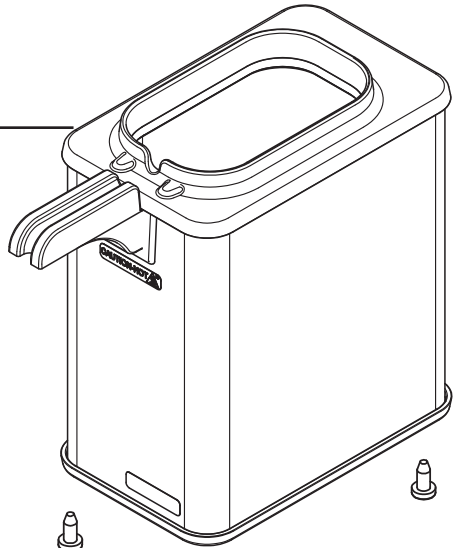

HOT FUDGE
MAGNETIC GRAPHIC
88911



FOOT
07429

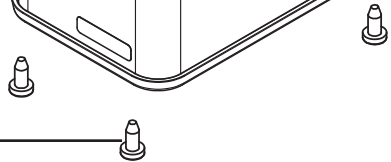

SAFETY



WARNING- ELECTRICAL SHOCK COULD OCCUR

This unit must be earthed or grounded.
This requires all three prongs (terminals) on cord
plug to be plugged into power source.



According to food and safety regulations, most foods must be stored and/or served at certain temperatures or they could become hazardous. Check with local food and safety regulators for specific guidelines.

Be aware of the product you are serving and the temperature the product is required to maintain. Server Products, Inc. can not be responsible for the serving of potentially hazardous product.

PRE-HEATING PRODUCT POUCHES

- Install pump with pouch.
(See UNIT SETUP, pg. 4.)
- Adjust thermostat to Ghirardelli's recommended serving temperature.

Make change-outs a cinch.

Place a reserve pouch in the bottom of the base.

When the primary pouch is emptied, the reserve pouch is pre-heated and ready for use.

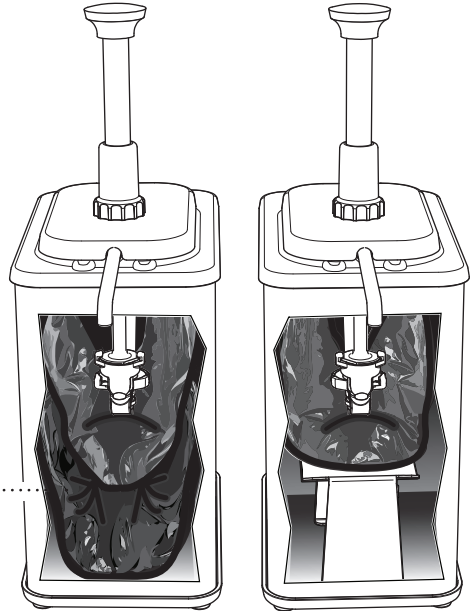

Cutaway views show:

**Reserve Pouch
in base bottom**

**Pouch Support
in base bottom**

UNIT SETUP

WASH ALL PARTS PROPERLY
BEFORE EVERY USE. See page 6.

SEE SEPARATE PUMP MANUAL FOR PUMP SETUP.

1 INSERT INTO BASE: POUCH SUPPORT OR RESERVE POUCH

IMPORTANT: A pouch support or reserve pouch gives the primary pouch the proper elevation to dispense all product and heat evenly.

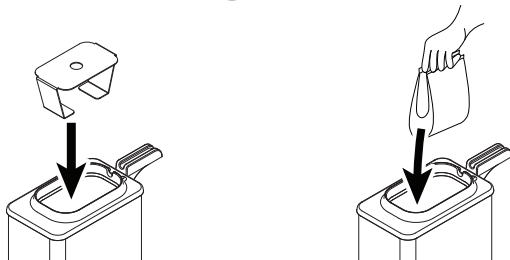

2 ATTACH PUMP TO PRIMARY POUCH

- Place pouch on countertop with pouch fitment circle facing upward.
- Position pump connector directly over center of pouch fitment.
- Press pump connector down to pierce through film in pouch fitment.

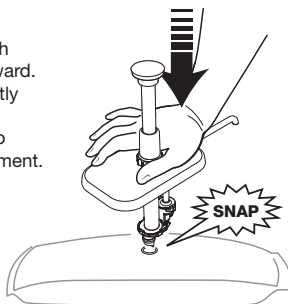

Pump is fully engaged when top surface of pouch fitment touches pump connector rim.

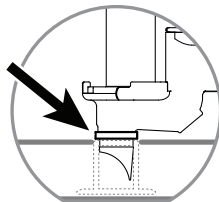

3 INSTALL PUMP WITH POUCH INTO BASE

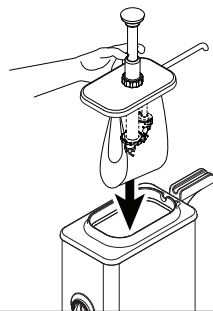

4 PLUG CORD into power source.

5 PRESS SWITCH to the "ON" position.

6 SET THERMOSTAT KNOB

to Ghirardelli's recommended serving temperature.

- Dial indicators use increments of 5° F.
- Thermostat maximum is 210° F/99° C.

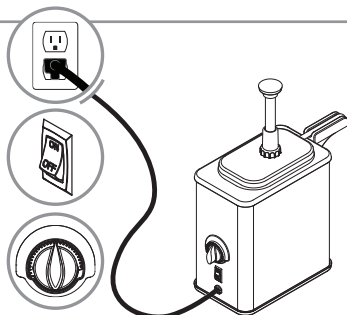

UNIT TAKE-DOWN

1 PRESS SWITCH to the "OFF" position.



2 UNPLUG CORD



CAUTION- HOT

Allow unit to cool before continuing or use proper care with hot surfaces.

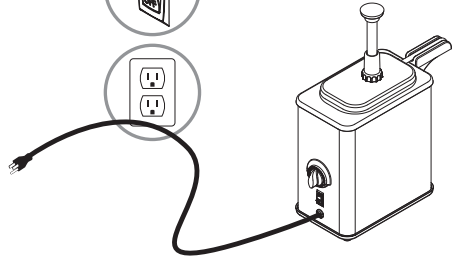

3 REMOVE PUMP WITH POUCH

4 REMOVE POUCH SUPPORT OR RESERVE POUCH

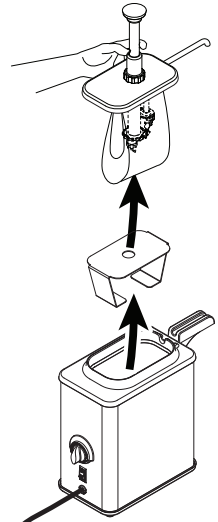

5 DETACH POUCH
from bottom of pump.

6 FLUSH AND RINSE PUMP
Thoroughly rinse all inside and outside surfaces of pump with hot water.

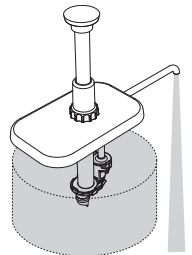

7 DISASSEMBLE AND CLEAN PUMP.
SEE SEPARATE PUMP MANUAL FOR PUMP CLEANING.

CLEANING



SEE SEPARATE PUMP MANUAL FOR PUMP INSTRUCTIONS.

WARNING- **ELECTRICAL SHOCK COULD OCCUR**

- Electrical components of unit could be damaged from water exposure or any liquid.
- Never immerse unit into water or any liquid.
- Never use any water jet or pressure sprayer on unit.
- Ensure unit is “OFF” and unplugged.

CAUTION- HOT

Allow unit to cool before cleaning.



CLEAN EXTERNAL SURFACES

- Wipe daily with a clean damp cloth.
- Dry with a clean soft cloth.
- Glass and surface cleaners approved for use in food contact areas may be used.

CARE OF STAINLESS STEEL

This warmer and accessories are constructed of stainless steel — one of the best materials for food serving and storage.

If you notice corrosion beginning on any stainless steel surface, you may need to change the cleansing agent, sanitizing agent, or the cleaning procedures you are using.

- A mildly abrasive nylon or brass brush may be used to remove any stubborn food or mineral deposits on interior surfaces of unit.
- Fully rinsing and drying all parts can help prevent corrosion. Elements and minerals in tap water can accumulate on stainless steel parts and create corrosion.
- Do not use abrasive, caustic or ammonia based cleansers.
- Do not use products containing acids, alkalines, chlorine, or salt. These agents can corrode stainless steel.
- Do not use metal scrapers or cleaning pads that could scratch surfaces.

WIRING

UNITS 85850 | 120V | USA

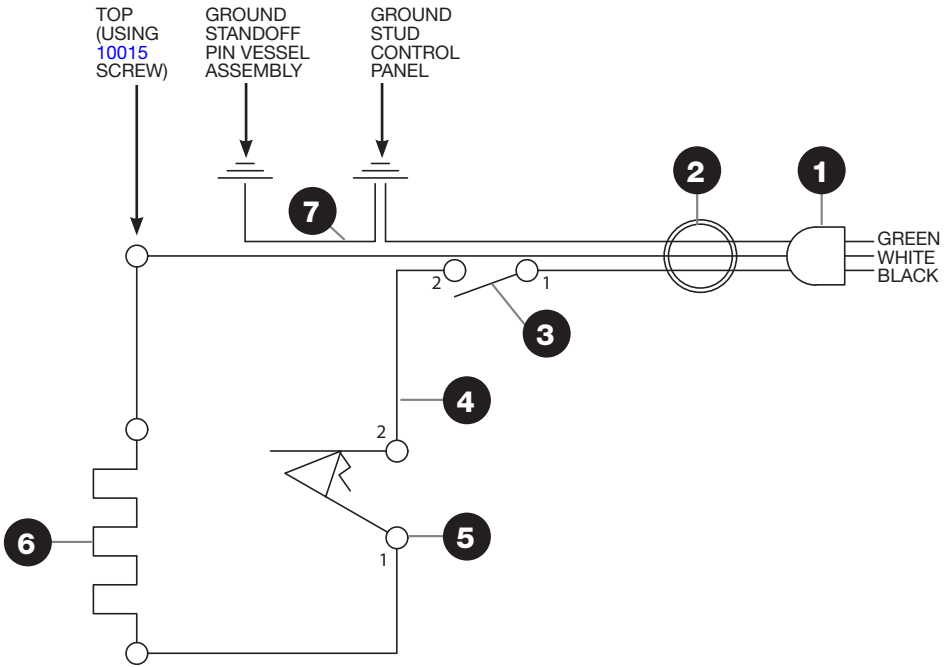

- 1** Cord Assembly
- 2** Bushing/Strain Relief
- 3** Snap-In Rocker Switch
- 4** 6" Wire Assembly, Black
- 5** Thermostat
- 6** Heating Element
- 7** 15" Wire Assembly, Green

TROUBLESHOOTING

UNIT DOES NOT HEAT?

- Ensure cord is securely plugged in.
- Ensure unit is on.
- Ensure thermostat knob is set correctly.
- Ensure power is available from source.
- Do not allow any of the electrical components to get wet. Moisture may cause the unit to trip breaker or GCFI. If moisture is suspected, discontinue use. Allow unit to fully air dry.

POUCH DOES NOT EVACUATE ALL PRODUCT?

- Ensure that the pouch is properly connected with pump.
- Ensure that the pouch being dispensed is raised to proper height. Always use either a pouch support or a reserve pouch beneath primary pouch.

SERVER PRODUCTS LIMITED WARRANTY

2 YEAR
WARRANTY



Server Products equipment is backed by a two-year limited warranty against defects in materials and workmanship.

For complete warranty information go to:

www.Server-Products.com

GENERAL SERVICE, REPAIR OR RETURNS

Before sending any item to Server Products for service, repair, or return, contact Server Products customer service to request a **Return Authorization Number**. Merchandise must be sent to Server Products with this number. Service is extremely prompt. Typically, units are repaired and ship out within 48 hours of receipt.

Merchandise being returned for credit must be in new and unused condition and not more than 90 days old and will be subject to a 20% restocking charge. Electrical parts (thermostats, heating elements, etc.) are not returnable.

Service Cord: Specific tools are required for safe and proper power supply cord removal and installation. If cord must be replaced, only a representative of the OEM (original equipment manufacturer) or a qualified technician may replace cord. Cord must meet code designation H05 RN-F requirements.

HELP or ORDERING REPLACEMENT PARTS

Server Products Inc.

3601 Pleasant Hill Road
Richfield, WI 53076 USA



262.628.5600 | 800.558.8722



SPSALES@SERVER-PRODUCTS.COM

Please be prepared with your **Model, Part and Series Numbers**. This information and other important data is located on the lid and/or base of the unit.