



S E R V E R

SERVE BETTER™



1 Gallon Server

MODEL: SY 1.0

85503 UNIT
1 GALLON SERVER

MODEL: SY 1.5

85470 UNIT
1½ GALLON SERVER

*Parts are available for unit 85470.
However, unit 85503 is the only
model currently approved by Arby's.*

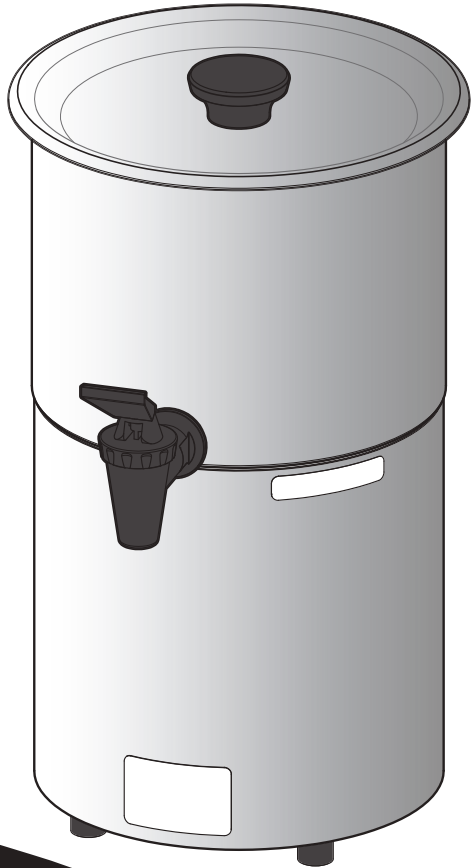

Thank You

...for purchasing this durable,
NSF listed holding unit. Its accurate
heat control simplifies dispensing.

WARM & SERVE AU JUS—SIMPLY!

PARTS FOR **85503** or **85470**

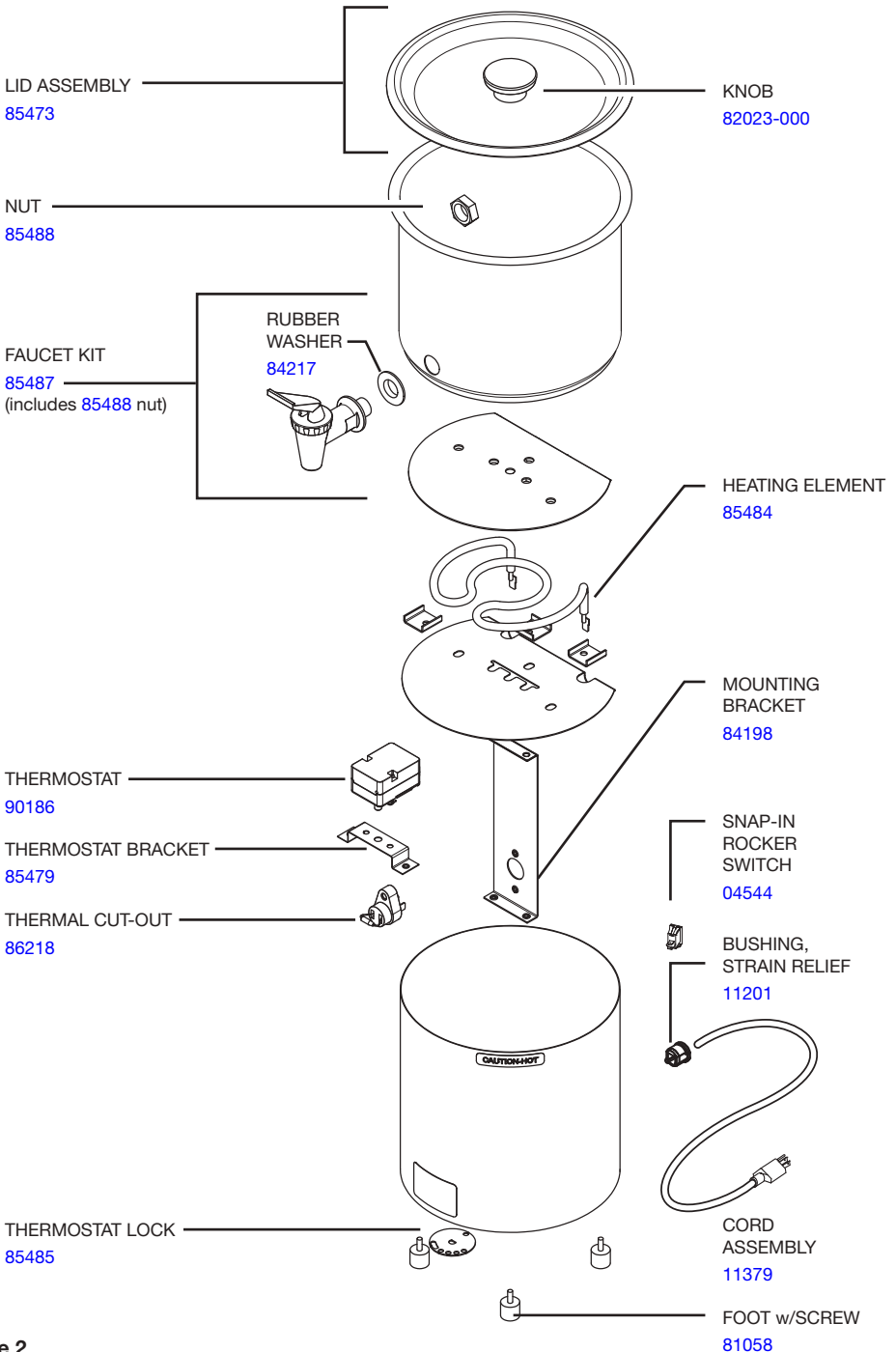

FAUCET ASSEMBLY

WASH ALL PARTS PROPERLY
BEFORE EVERY USE. See page 6.

1 INSERT CUP SEAT

into faucet.

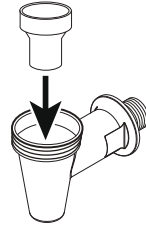

2 INSTALL TOP

onto faucet.

TIP: Lubricate threads with a small amount of clean water.

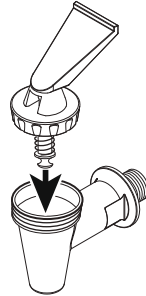

3 ROTATE TOP CLOCKWISE

to secure.

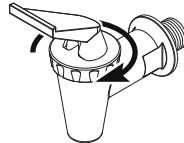

4 INSTALL WASHER

onto threaded shank of faucet.

IMPORTANT:

- Flat side of washer must face faucet.
- Round side of washer must face away from faucet.

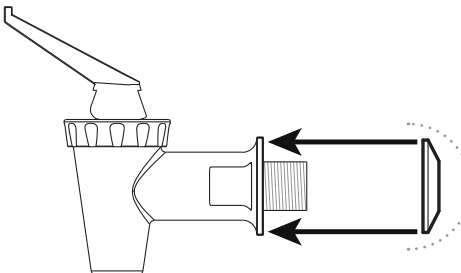
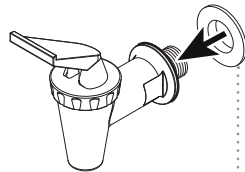

UNIT SETUP

**WASH ALL PARTS PROPERLY
BEFORE EVERY USE.** See page 6.

See page 3 for **FAUCET ASSEMBLY**

1 INSTALL FAUCET

into hole.
Attach nut to faucet from inside vessel.

YES

- Round side of washer seals inside hole.
- Tighten nut until snug.

NO

- Flat side of washer must not face hole.
- Do not over-tighten nut.

*Overtightened nut will strip threads
and cause washer to leak.
Overtightened nut will flatten washer
and cause leak.*

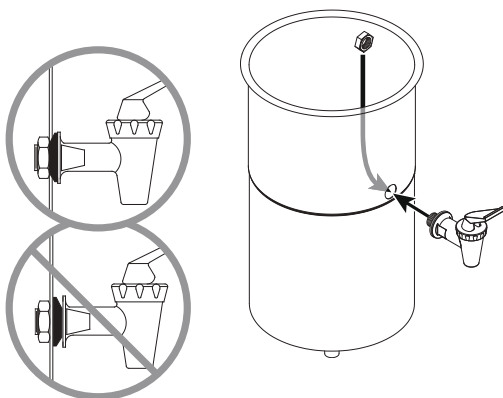

2 POUR PRE-HEATED AU JUS INTO THE UNIT

COVER WITH LID

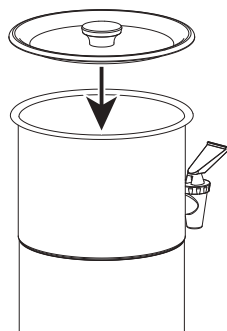

3 PLUG CORD

into power source.

4 PRESS SWITCH

to the "ON" position.
Thermostat is factory preset at 160 °F.

*To adjust TEMPERATURE SETTING,
see page 7.*

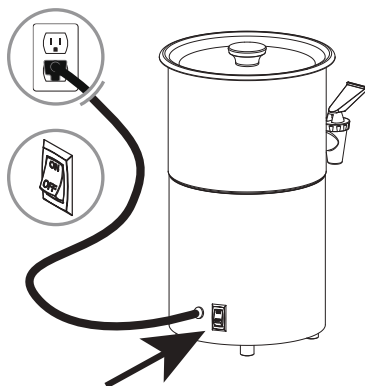

UNIT TAKE-DOWN

1 PRESS SWITCH to the “OFF” position.

2 UNPLUG CORD



CAUTION- HOT

Allow unit to cool before continuing or use proper care with hot surfaces.

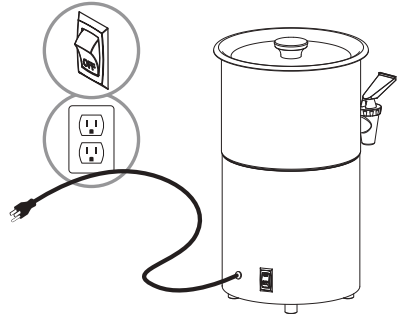

3 REMOVE LID

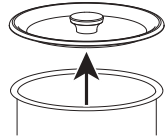

4 DISCARD AU JUS

IMPORTANT:

Au Jus may not be used the next day.

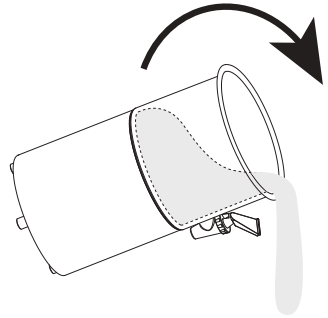

5 REMOVE FAUCET

Unscrew nut from inside vessel.

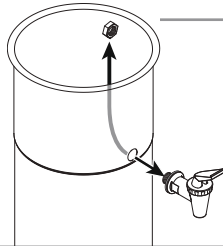

6 DISASSEMBLE FAUCET

Take apart all four pieces.

IMPORTANT:

PREVENT DRIPPING

Disassemble and clean faucet daily.

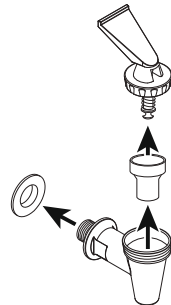

SAFETY



WARNING- ELECTRICAL SHOCK COULD OCCUR

This unit must be earthed or grounded.
This requires all three prongs (terminals) on cord
plug to be plugged into power source.



According to food and safety regulations, most foods must be stored and/or served at certain temperatures or they could become hazardous. Check with local food and safety regulators for specific guidelines.

Be aware of the product you are serving and the temperature the product is required to maintain. Server Products, Inc. can not be responsible for the serving of potentially hazardous product.

CLEANING



WARNING- ELECTRICAL SHOCK COULD OCCUR

- Electrical components of unit could be damaged from water exposure or any liquid.
- Never immerse unit into water or any liquid.
- Never use any water jet or pressure sprayer on unit.
- Ensure unit is "OFF" and unplugged.

CAUTION- HOT

Allow unit to cool before cleaning.



CLEAN EXTERNAL SURFACES

- Wipe daily with a clean damp cloth.
- Dry with a clean soft cloth.
- Glass and surface cleaners approved for use in food contact areas may be used.



CLEAN VESSEL, LID & FAUCET DAILY

- 1 CLEAN**
After disassembling, thoroughly clean all washable parts with soap and hot water.
- 2 RINSE** fully with clear water.
- 3 SANITIZE**
all parts according to local sanitization requirements. All parts in contact with food must be sanitized.
- 4 DRY**
Air dry faucet parts fully.
Dry stainless steel with clean, soft cloth.

CARE OF STAINLESS STEEL

This server is constructed of stainless steel— one of the best materials for food serving and storage.

If you notice corrosion beginning on any stainless steel surface, you may need to change the cleansing agent, sanitizing agent, or the cleaning procedures you are using.

- A mildly abrasive nylon or brass brush may be used to remove any stubborn food or mineral deposits on interior surfaces of unit.
- Fully rinsing and drying all parts can help prevent corrosion. Elements and minerals in tap water can accumulate on stainless steel parts and create corrosion.
- Do not use abrasive, caustic or ammonia based cleansers.
- Do not use products containing acids, alkalines, chlorine, or salt. These agents can corrode stainless steel.
- Do not use metal scrapers or cleaning pads that could scratch surfaces.

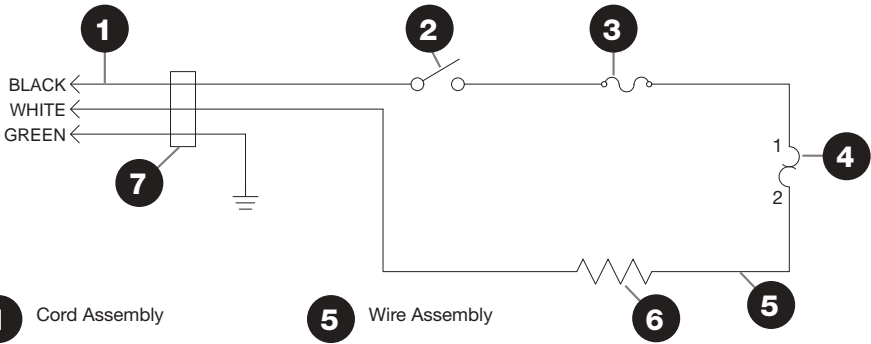

- 1 Cord Assembly
- 5 Wire Assembly
- 2 Snap-In Rocker Switch
- 6 Heating Element
- 3 Thermal Cut-Out
- 7 Bushing, Strain Relief
- SERIES 14C & 14H
- 4 Thermostat

TEMPERATURE SETTING

Thermostat is preset at 160°F

Temperature setting is adjustable in 20°F increments from 80°F – 180°F.*

**To change setting:
ADJUST THERMOSTAT LOCK**

Vessel must be empty.
Set unit upside down.

1 REMOVE SCREW from lock.

2 ROTATE LOCK to desired temperature.

3 SECURE THERMOSTAT LOCK with screw to set temperature.

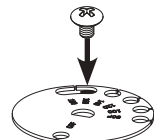
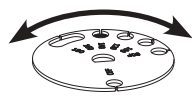
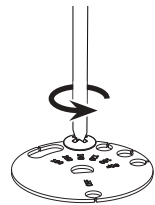
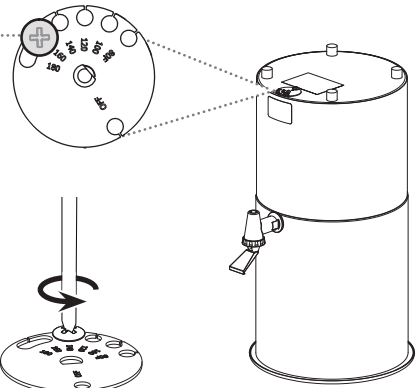

*Temperature is preset at 71°C.
Setting is adjustable in 11°C increments from 26.6°C – 82.2°C.

TROUBLESHOOTING

UNIT DOES NOT HEAT?

- Ensure cord is securely plugged in.
- Ensure unit is on.
- Ensure thermostat lock is set correctly.
- Ensure power is available from source.
- Do not allow any of the electrical components to get wet. Moisture may cause the unit to trip breaker or GCFI. If moisture is suspected, discontinue use. Allow unit to fully air dry.

FAUCET LEAKS?

- Fully disassemble and clean faucet daily.
- Ensure that washer is installed with flat side towards faucet.

YES

- Round side of washer seals inside hole.
- Tighten nut until snug.

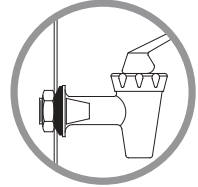

NO

- Flat side of washer must not face hole.
- Do not over-tighten nut.
Overtightened nut will strip threads and cause washer to leak.
Overtightened nut will flatten washer and cause leak.

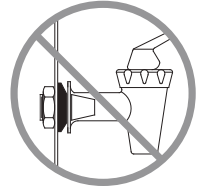

SERVER PRODUCTS LIMITED WARRANTY

2
YEAR
WARRANTY



Server Products equipment is backed by a two-year limited warranty against defects in materials and workmanship.

For complete warranty information go to:

www.Server-Products.com

GENERAL SERVICE, REPAIR OR RETURNS

Before sending any item to Server Products for service, repair, or return, contact Server Products customer service to request a **Return Authorization Number**. Merchandise must be sent to Server Products with this number. Service is extremely prompt. Typically, units are repaired and ship out within 48 hours of receipt.

Merchandise being returned for credit must be in new and unused condition and not more than 90 days old and will be subject to a 20% restocking charge. Electrical parts (thermostats, heating elements, etc.) are not returnable.

Servicing Cord: Specific tools are required for safe and proper power supply cord removal and installation. If cord must be replaced, only a representative of the OEM (original equipment manufacturer) or a qualified technician may replace cord. Cord must meet code designation H05 RN-F requirements.

NEED HELP?

Server Products Inc.

3601 Pleasant Hill Road
Richfield, WI 53076 USA



262.628.5600 | 800.558.8722



SPSALES@SERVER-PRODUCTS.COM

Please be prepared with your **Model, Part and Series Numbers**. This information and other important data is located on the base of the unit.