



INSTALLATION AND OPERATING INSTRUCTIONS

Manual Bagging Stations

Models:
BS-1 & SBS-1

INTENDED FOR OTHER THAN HOUSEHOLD USE



WARNING: Improper installation, adjustment, alteration, service or maintenance can cause property damage, injury or death. Read the Installation, Operating and Maintenance Instructions thoroughly before installing or servicing this equipment.



IMPORTANT FOR FUTURE REFERENCE

Please complete this information and retain this manual for the life of the equipment. For Warranty Service and/or Parts, this information is required.

Model Number

Serial Number

Date Purchased

This equipment has been engineered to provide you with year-round dependable service when used according to the instructions in this manual and standard commercial kitchen practices.

Phone: +1 (307) 634-5801
Fax: +1 (307) 637-8071
Toll Free: +1 (800) 752-0863
Website: www.apwwyott.com
E-mail: info@apwwyott.com

P/N 88140-00 9/05

APW WYOTT
P.O. Box 1829
Cheyenne, WY 82003

APW Wyott takes pride in the design and quality of our products. When used as intended and with proper care and maintenance, you will experience years of reliable operation from this equipment. To ensure best results, it is important that you read and follow the instructions in this manual carefully.



Installation and start-up should be performed by a qualified installer who thoroughly read, understands and follows these instruction.



If you have questions concerning the installation, operation, maintenance or service of this product, write Technical Service Department APW/Wyott Foodservice Equipment Company, P.O. Box 1829, Cheyenne, WY 82003.



SAFETY PRECAUTIONS



Before installing and operating this equipment be sure everyone involved in its operation are fully trained and are aware of all precautions. Accidents and problems can result by a failure to follow fundamental rules and precautions.



The following words and symbols, found in this manual, alert you to hazards to the operator, service personnel or the equipment. The words are defined as follows:



 **DANGER:** This symbol warns of imminent hazard which will result in serious injury or death. 



 **WARNING:** This symbol refers to a potential hazard or unsafe practice, which could result in serious injury or death. 



 **CAUTION:** This symbol refers to a potential hazard or unsafe practice, which may result in minor or moderate injury or product or property damage. 



 **NOTICE:** This symbol refers to information that needs special attention or must be fully understood even though not dangerous. 



 **CAUTION:** These models are designed, built, and sold for commercial use. If these models are positioned so the general public can use the equipment make sure that cautions, warnings, and operating instructions are clearly posted near each unit so that anyone using the equipment will use it correctly and not injure themselves or harm the equipment. 



 **IMPORTANT:** We strongly recommend having a licensed electrician install this equipment. The electrician should be familiar with all local and national electrical codes. 



 **WARNING:** Check the data plate on this unit before installation. Connect the unit only to the voltage and frequency listed on the data plate. Connect only to 1 or 3 phase as listed on the data plate. 

 **NOTICE:** The unit when installed, must be electrically grounded and comply with local codes, or in the absence of local codes, with the national electrical code ANSI/NFPA70- latest edition. Canadian installation must comply with CSA-STANDARD C.22.2 Number 0 M1982 General Requirements-Canadian Electrical Code Part II, 109-M1981- Commercial Cooking Appliances. 

 **WARNING:** Disconnect device from electrical power supply and place a Tag Out-Lockout on the power plug, indicating that you are working on the circuit. 

 **WARNING:** Install per the spacing requirements listed in the installation section of this manual. We strongly recommend having a competent professional install the equipment. A licensed electrician should make the electrical connections and connect power to the unit. Local codes should always be used when connecting these units to electrical power. In the absence of local codes, use the latest version of the National Electrical Code. 

 **WARNING:** Improper installation, adjustment, alteration, service or maintenance can cause property damage, injury or death. Read the Installation, Operating and Maintenance Instructions thoroughly before installing or servicing this equipment. 

 **CAUTION:** Maintenance & repair should be handled by a factory authorized agent. Before doing any maintenance or repair, contact APW Wyott. 

EQUIPMENT SET UP

Installation:

Location:

While convenience and accessibility are important considerations when locating your BS-I & SBS-I, the following considerations must also be adhered to:

- The countertop that the unit is placed on must be strong enough to support the unit. We recommend that the counter be capable of supporting 350 pounds.
- The unit must have the legs that were supplied installed. If the legs are not installed, the unit will not work properly.
- Be sure to install the unit at a convenient serving height.
- Be sure to level the unit.

Electrical Connections:

Be sure to connect the unit to a 120 Volt, 60 Hz, 1 Phase grounded receptacle that is protected with a 15 ampere fuse or circuit breaker. The unit is supplied with a 6 foot cord. Avoid using extension cords as they may not be able to supply the proper voltage to the unit, resulting in damage to the unit. If extension cords are used they must be large enough to carry the load for the distance.

Operation

Initial Start-up:

The unit will start as soon as power switch is moved to the on position. If the unit doesn't start when it is plugged in and the power switch is on, check to make sure that the receptacle is live. Allow the unit to operate for at least 1/2 hour before loading it with product.

Temperature Control:

SBS-1 only: The temperature controls are located on the overhead element housing. Allow the unit a minimum of a 1/2 hour to respond to the change of setting before readjusting.

Cleaning:

Cabinet Surfaces:

The cabinet is constructed of stainless steel both inside and out. It should be cleaned daily with a solution of warm, soapy water. If the surface becomes stained or discolored, do not attempt to clean with a scouring pad or an abrasive cleaner. Use a soft cleaner and rub in the direction of the grain on the stainless steel to avoid scratching the surface. Glass surfaces should be cleaned with a suitable glass cleaner.

If the unit is maintained daily, replacing the merchandising bulbs should be the only long term maintenance items requiring attention.

WIRING DIAGRAM BS-1

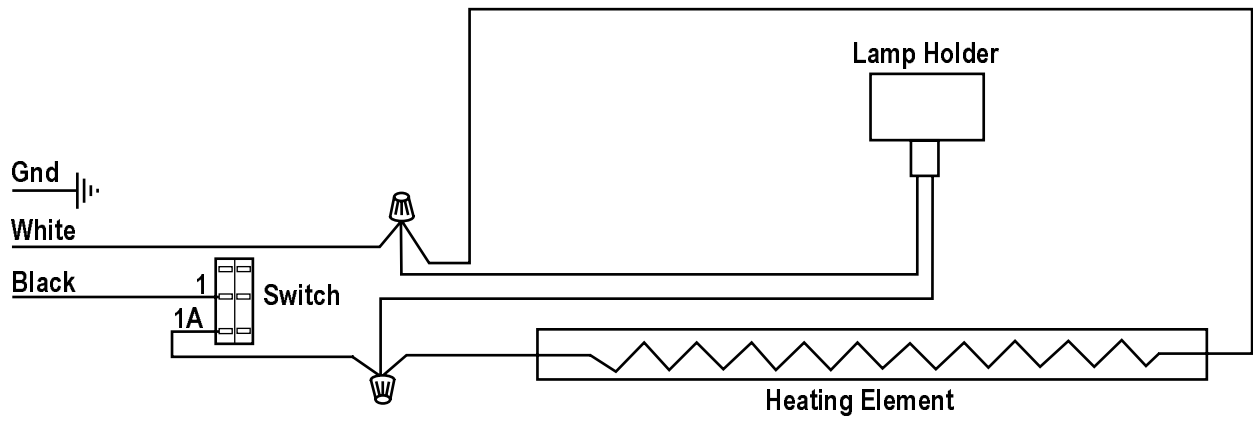

WIRING DIAGRAM SBS-1

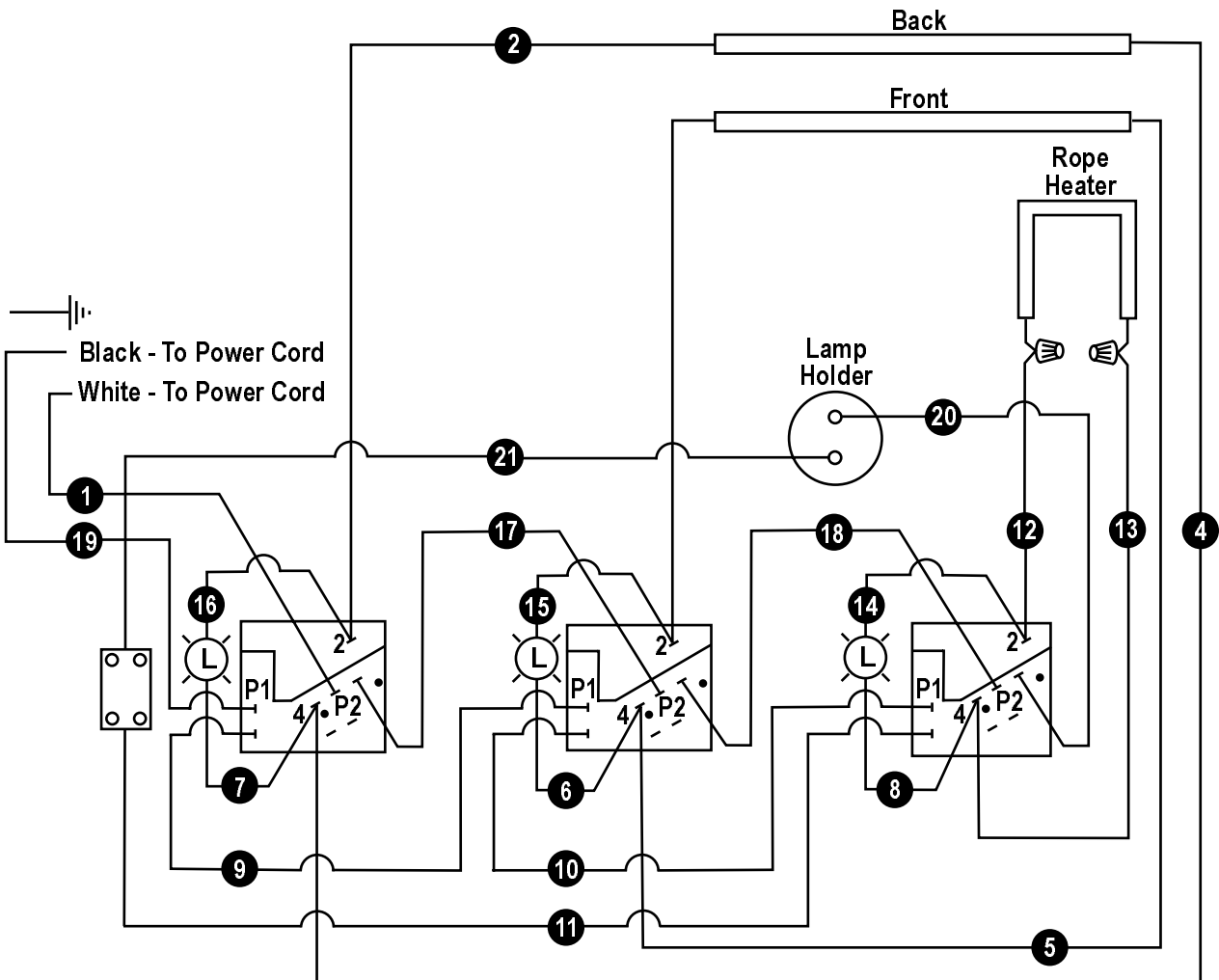

EXPLODED VIEW SBS-1

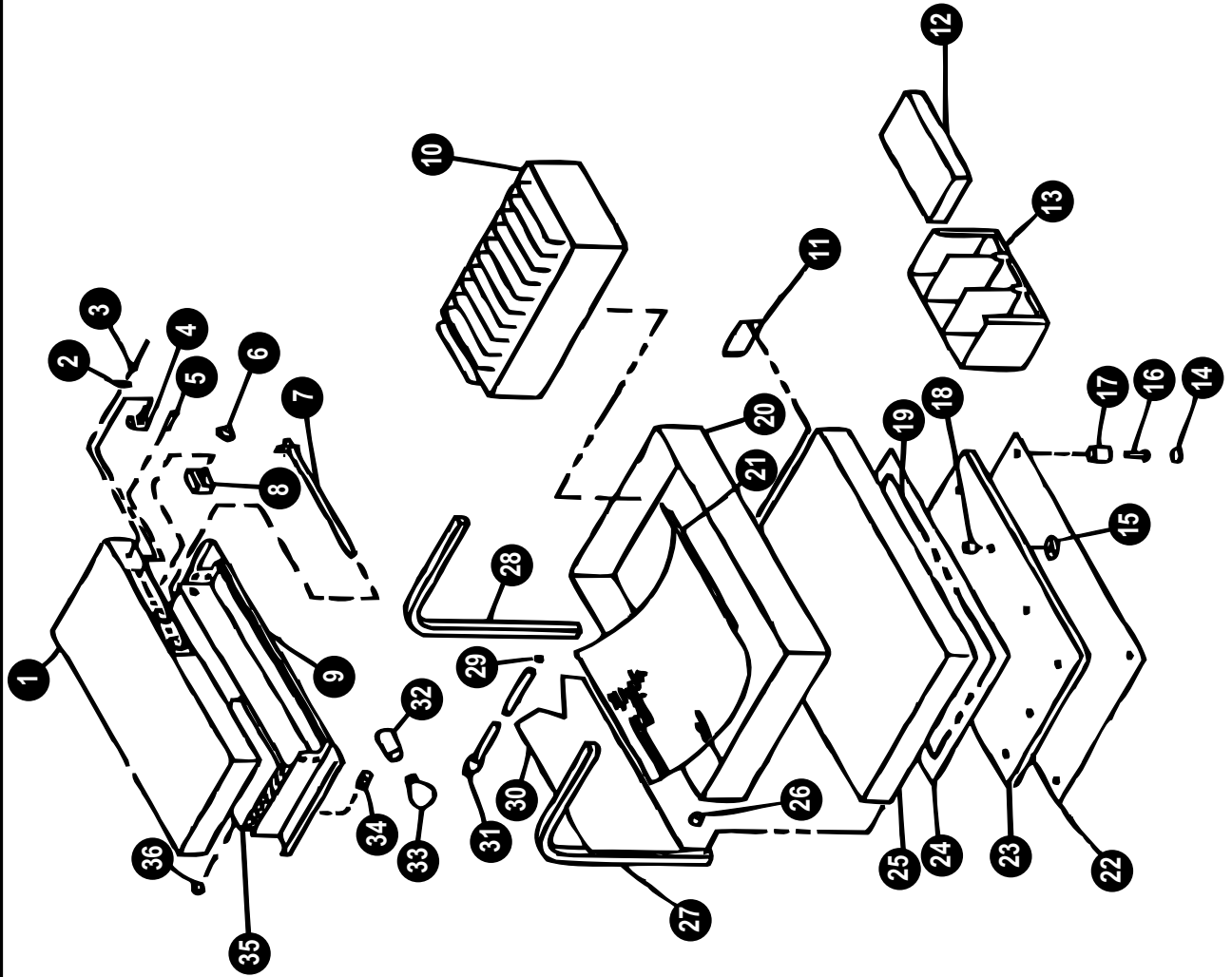

PARTS LIST SBS-1

Item	Part Number	Description	Quan
1	217525-13	Element Canopy	1
2	13010-00	Switch Plate	1
3	Ref	Nut Retaining	1
4	13274-00	Power Switch	1
5	15205-00	Pilot Light	3
6	87307-00	Control Knob	3
7	14310-02	Element	2
8	13268-00	Infinite Switch	3
9	217525-12	Element Housing	1
10	217525-06	Bag Rack	1
11	217525-28	Access Panel	1
12	217525-08	Base Front	1
13	217525-09	Box Weldment	1
14	21164-02	Foot Stick-On	4
15	85023-00	Washer	13
16	82082-00	1/4-20 X 3/4 MS	4
17	217436-50	Foot	4
18	86011-00	Spacer	13
19	14311-02	Rope Heater	1
20	217525-05	Lower Bottom	1
21	211101-00	Potato Bed	1
22	217525-04	Base Plate	1
23	217525-03	Hold Down Plate	1
24	217525-02	Distribution Plate	1
25	217525-01	Base	1
26	86011-00	Spacer	-
27	217525-10	Upright "A"	1
28	217525-07	Upright "B"	1
29	15035-00	Cable Clamp	1
30	217525-11	Fry Deflector	1
31	15325-00	Power Cord	1
32	15057-00	Lampholder	1
33	15058-00	Bulb 40 Watt	2
34	20023-00	Nipple	1
35	217525-26	Insulation Top	1
36	20003-00	Knurled Nut	2

EXPLODED VIEW BS-1

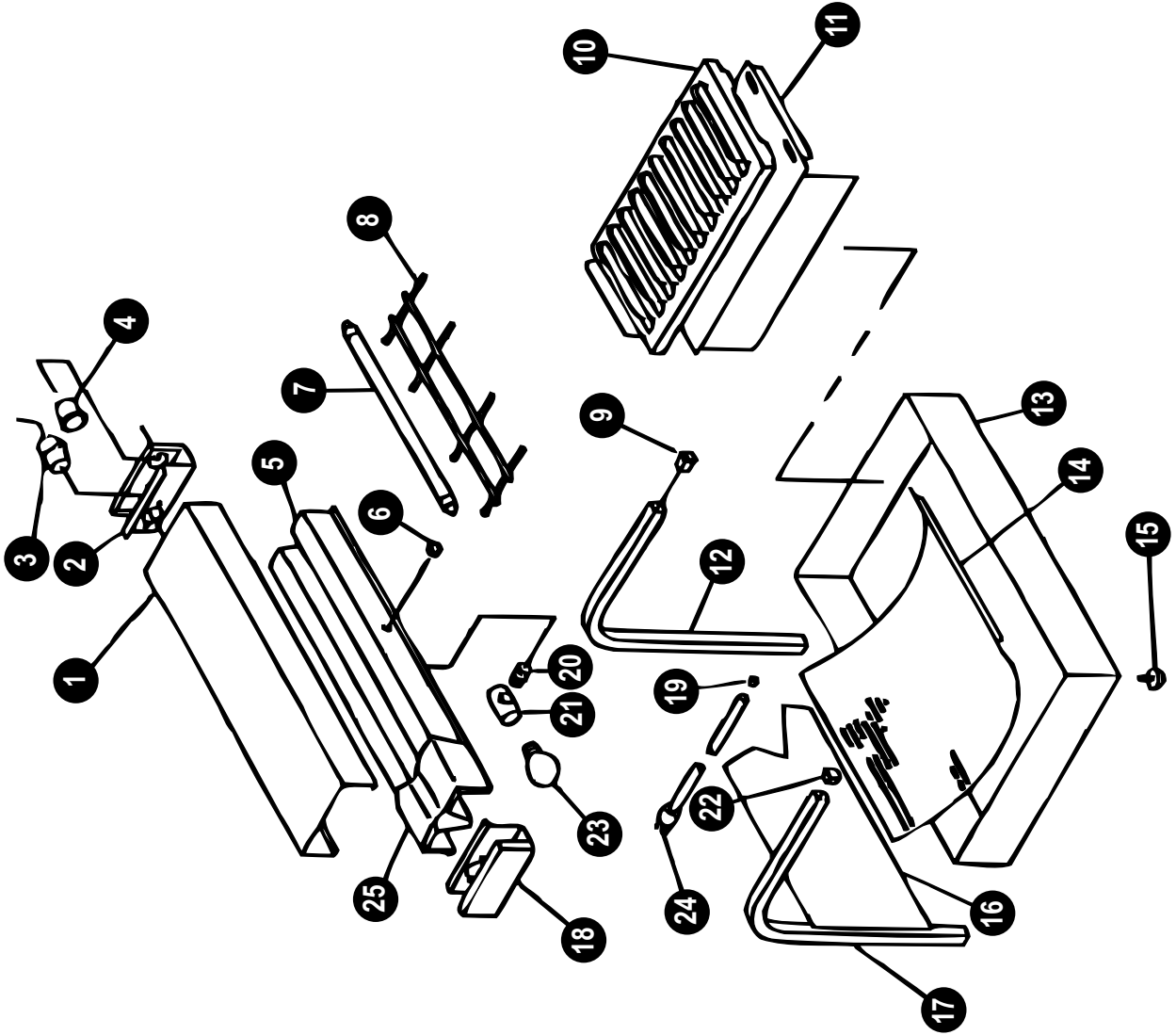

PARTS LIST BS-1

Item	Part Number	Description	Quan
1	217735-10	SKIN	1
2	217735-08	END CAP RH	1
3	31008-01	HEATER SOCKET	2
4	89670-00	SNAP BUSHING	1
5	217735-11	REFLECTOR	1
6	20003-00	KNURLED NUT	1
7	217735-16	ELEMENT HEATING	1
8	217735-15	WIRE GUARD	1
9	13586-00	SWITCH ON-OFF	1
10	217735-22	BAG RACK	1
11	217735-21	BAG PLATE	1
12	217735-05	UPRIGHT RH	1
13	217735-09	BODY	1
14	211101-00	POTATO BED	1
15	21192-00	FEET BUMPER	4
16	217735 14	FRY DEFLECTOR	1
17	217735-06	UPRIGHT LH	1
18	217735-07	END CAP LH	1
19	89674-00	STRAIN RELIEF	1
20	20023-00	NIPPLE	1
21	15057-00	LAMPHOLDER	1
22	16209-00	PLUG	3
23	15058-00	BULB 40 WATT	2
24	15325-00	POWER CORD	1
25	217735-25	INSULATION	1

APW WYOTT EQUIPMENT LIMITED WARRANTY

APW Wyott Foodservice Equipment Company warrants its equipment against defects in materials and workmanship, subject to the following conditions:

This warranty applies to the original owner only and is not assignable.

Should any product fail to function in its intended manner under normal use within the limits defined in this warranty, at the option of APW Wyott such product will be repaired or replaced by APW Wyott or its Authorized Service Agency. APW Wyott will only be responsible for charges incurred or service performed by its Authorized Service Agencies. The use of other than APW Wyott Authorized Service Agencies will void this warranty and APW Wyott will not be responsible for such work or any charges associated with same. The closest APW Wyott Authorized Service Agent must be used.

This warranty covers products shipped into the 48 contiguous United States, Hawaii, metropolitan areas of Alaska and Canada. There will be no labor coverage for equipment located on any island not connected by roadway to the mainland.

Warranty coverage on products used outside the 48 contiguous United States, Hawaii, and metropolitan areas of Alaska and Canada may vary. Contact the international APW Wyott distributor, dealer, or service agency for details.

Time Period

One year for parts and one year for labor, effective from the date of purchase by the original owner. The Authorized Service Agency may, at their option, require proof of purchase. Parts replaced under this warranty are warranted for the un-expired portion of the original product warranty only.

Exceptions

- ***Gas/Electric Cookline:** Models GCB, GCRB, GF, GGM, GGT, CHP-H, EF, EG, EHP. Three (3) Year Warranty on all component parts, except switches and thermostats. (2 additional years on parts only. No labor on second or third year.)
- ***Broiler Briquettes, Rock Grates, Cooking Grates, Burner Shields, Fireboxes:** 90 Day Material Only. No Labor.
- ***Heat Strips:** Models FD, FDL, FDD, FDDL. Two (2) Year Warranty on element only. No labor second year.
- ***Glass Windows, Doors, Seals, Rubber Seals, Light Bulbs:** 90 Day Material Only. No Labor.

In all cases, parts covered by extended warranty will be shipped FOB the factory after the first year.

Portable Carry In Products

Equipment weighing over 70 pounds or permanently installed will be serviced on-site as per the terms of this warranty. Equipment weighing 70 pounds or under, and which is not permanently installed, i.e. with cord and plug, is considered portable and is subject to the following warranty handling limitations. If portable equipment fails to operate in its intended manner on the first day of connection, or use, at APW Wyott's option or its Authorized Service Agency, it will be serviced on site or replaced.

From day two through the conclusion of this warranty period, portable units must be taken to or sent prepaid to the APW Wyott Authorized Service Agency for in-warranty repairs. No mileage or travel charges are allowed on portable units after the first day of use. If the customer wants on-site service, they may receive same by paying the travel and mileage charges. Exceptions to this rule: (1) countertop warmers and cookers, which are covered under the Enhanced Warranty Program, and (2) toasters or rollergrills which have in store service.

Exclusions

The following conditions are not covered by warranty:

- *Equipment failure relating to improper installation, improper utility connection or supply and problems due to ventilation.
- *Equipment that has not been properly maintained, calibration of controls, adjustments, damage from improper cleaning and water damage to controls.
- *Equipment that has not been used in an appropriate manner, or has been subject to misuse or misapplication, neglect, abuse, accident, alteration, negligence, damage during transit, delivery or installation, fire, flood, riot or act of god.
- *Equipment that has the model number or serial number removed or altered.

If the equipment has been changed, altered, modified or repaired by other than an Authorized Service Agency during or after the warranty period, then the manufacturer shall not be liable for any damages to any person or to any property, which may result from the use of the equipment thereafter.

This warranty does not cover services performed at overtime or premium labor rates. Should service be required at times which normally involve overtime or premium labor rates, the owner shall be charged for the difference between normal service rates and such premium rates. APW Wyott does not assume any liability for extended delays in replacing or repairing any items beyond its control.

In all cases, the use of other than APW Wyott Authorized OEM Replacement Parts will void this warranty.

This equipment is intended for commercial use only. Warranty is void if equipment is installed in other than commercial application.

Water Quality Requirements

Water supply intended for a unit that has in excess of 3.0 grains of hardness per gallon (GPG) must be treated or softened before being used. Water containing over 3.0 GPG will decrease the efficiency and reduce the operation life of the unit.

Note: Product failure caused by liming or sediment buildup is not covered under warranty.

“THE FOREGOING WARRANTY IS IN LIEU OF ANY AND ALL OTHER WARRANTIES EXPRESSED OR IMPLIED INCLUDING ANY IMPLIED WARRANTY OF MERCHANTABILITY OR FITNESS FOR PARTICULAR PURPOSES AND CONSTITUTES THE ENTIRE LIABILITY OF APW WYOTT. IN NO EVENT DOES THE LIMITED WARRANTY EXTEND BEYOND THE TERMS STATED HEREIN.”

9/05