



Tankless Gas Water Heating
Replacement Parts and Accessories Catalog

TANKLESS WATER HEATING PARTS & ACCESSORIES

2016 CATALOG



Ruud.com

RELY ON RUUD.™

Table Of Contents

General Terms and Conditions.....	3
Contact Information.....	4
Parts Kits.....	5
Tankless Accessories.....	6
Maintenance and Service.....	6
Manifold Systems.....	7
Tankless Venting.....	8-9
Parts for RUTGH-84DVLN-1, RUTGH-90DVLN-1, RUTGH-95DVLN-1 Series.....	10-11
Parts for RUTGH-84XLN-1, RUTGH-90XLN-1, RUTGH-95XLN-1 Series.....	12-13
Parts for RUTG-64DVLN-1, RUTG-84DVLN-1, RUTG-95DVLN-1 Series.....	14-15
Parts for RUTG-64XLN-1, RUTG-84XLN-1, RUTG-95XLN-1 Series.....	16-17
Parts for RUTGH-84DV, RUTGH-90DV, RUTGH-95DV Series.....	18-19
Parts for RUTGH-84X, RUTGH-90X, RUTGH-95X Series.....	20-21
Parts for RUTG-64, RUTG-84, RUTG-95, DV and DVL Series.....	22-23
Parts for RUTG-64, RUTG-84, RUTG-95, X and XL Series.....	24-25
Tankless Model Cross Reference.....	26-27

General Terms and Conditions

A comprehensive catalog of approved replacement parts

for Ruud® and Rheem® tankless gas water heaters*.

Freight Allowance

Please see the Tankless Parts and Accessories Price Sheet for Freight Allowances.

Taxes

Prices are subject to the addition of any tax imposed by any present or future Federal, State, County or Municipal law on the sale of such material, unless we have a tax exemption certificate on file.

Acceptance of Orders

All orders are subject to final approval on the terms and conditions contained in our standard customer acknowledgment form.

Materials Return

Saleable, current component parts in a new or unused condition must have prior authorization by the Parts Packaging Supervisor or Customer Service before being returned. Parts may only be considered for return within 90 days from the original invoice date. Invoice numbers must be provided to Customer Service prior to obtaining a return authorization number. All parts returned without prior authorization will be destroyed or sent back to the sender at their expense. All returns will be subject to our inspection and a 25% restocking charge. Returned parts that are damaged or in a condition that prevents resale will not be credited. Service/Warranty Parts returned in accordance with warranty claim provisions do not require prior authorization, but will be subject to our inspection. See Price Sheet for Additional Conditions.

Parts Warranty

All tankless service parts are warranted for the remainder of the parts warranty covering the product they are being used to service. If no warranty is remaining on said product then the warranty will be for a period of 90 days from the date of purchase. Contact Technical Service for warranty information.

Accessories Warranty

All tankless accessories are warranted for a period of 1 year from the date of original purchase unless covered by a manufacturers warranty. Contact Technical Service for warranty information.

* For Rheem, replace RUTG with RTG

CONTACT INFORMATION

Customer Service

800-621-5622

Product Information/Online Lookup

ruudparts.com

Warranty

MyRuud.com

Fax: 800.535.9538

Email: parts@rheem.com

Technical Service

866.720.2076

Email: techserv@rheem.com

To Place an Order

800.621.5622

Fax: 800.535.9538



Located in Randleman, North Carolina with a 185,000 sq. ft. distribution center, the Replacement Parts Division provides products and services including the support of new equipment sales by providing OEM replacement parts, and parts identification. In addition, we sell and market aftermarket parts and products that are included in the installation, maintenance and servicing of HVAC equipment, water heaters and other residential power equipment.

TANKLESS GAS WATER HEATER PARTS KITS

for Ruud Tankless Water Heaters

Ruud introduces the Tankless Gas Water Heater Service parts kits. These kits, designed with the contractor in mind, provide all the basic parts necessary for a complete repair of a Ruud tankless gas water heater.

PROTECH™

PROTECH PD966349 - Mid-Efficiency direct vent models
(RUTG-95DVL-1, RUTG-84DVL-1, RUTG-64DVL-1)

PROTECH PD966350 - Mid-Efficiency outdoor models
(RUTG-95XL-1, RUTG-84XL-1, RUTG-64XL-1)

PROTECH PD966351 - Condensing models
(RUTGH-95DVL-1, RUTGH-90DVL-1, RUTGH-84DVL-1)
(RUTGH-95XL-1, RUTGH-90XL-1, RUTGH-84XL-1)

These kits include 1 each of the following:

- Control Board
- Thermistors
- Gas Valve
- Flame Rods
- Flame Rod Wires
- Ignitor Coil
- Ignitor Rod
- Gas Valve Assembly
- Gas Inlet Connector
- Blower Motor
- Water Control Valves
- Drain Plug
- Inlet Water Filter
- Screw Kit
- O-ring Kit
- Remote Control



PROTECH Kits for Older Models:

PROTECH PD966332 - Mid-Efficiency direct vent models (RUTG-95DVL, RUTG-84DVL, RUTG-64DVL)

PROTECH PD966333 - Mid-Efficiency outdoor models (RUTG-95XL, RUTG-84XL, RUTG-64XL)

PROTECH PD966334 - Condensing models (RUTGH-95DVL, RUTGH-90DVL, RUTGH-84DVL)
(RUTGH-95XL, RUTGH-90XL, RUTGH-84XL)

Tankless Accessories

Finish and Appearance



Cosmetic Pipe Covers
Pipe covers enhance an indoor or outdoor installation by concealing the piping beneath the water heater. It provides protection from tampering and weather conditions. These covers come in a grey finish to match the tankless heater.

Dimensions: Width and depth of the heater, all are 16-1/2" tall.

- **RTG20227 (grey)**
For the RUTGH-95DV, RUTGH-95X, RUTGH-90DV, RUTGH-90X, RUTGH-84DV, and RUTGH-84X models*
- **RTG20217DVG (grey)**
For the RUTG-95DV, RUTG-84DV, RUTG-64DV and RUTG-66DV models*
- **RTG20217XG (grey)**
For the RUTG-95X, RUTG-84X, RUTG-64X and RUTG-66X models*
*Kits also applicable to models with "-1"



Outdoor Recess Boxes
Recess boxes enhance an outdoor installation by protecting the tankless unit from damage and tampering. It also provides additional protection from extreme weather. These boxes come in a grey finish and can be painted by the customer.

- **RTG20226**
For the RUTGH-95, RUTGH-90 and RUTGH-84 X and XL models*
Rough-in Dimensions: 46" High, 19-1/2" Wide, 9-1/2" Deep
- **RTG20253 - Recess Box for Stucco Applications**
For the RUTGH-84XL, RUTGH-90XL and RUTGH-95XL models*
Rough-in Dimensions: 46" High, 19-1/2" Wide, 9-1/2" Deep
- **RTG20218**
For the RUTG-64, RUTG-84, and RUTG-95 X and XL models*
Rough in Dimensions: 42" High, 14-1/2" Wide, 8-1/2" Deep
- **RTG20238 - Retrofit Kit for 74X Recess Box**
Allows an RUTG-95XL, RUTG-84XL, RUTG-64XL models*, to be installed in a first generation 74 Series Recess box without changing the box out. Kit includes 2 brackets, hardware, and instructions.
- **RTG20243 (grey)**
For the RUTG-95, RUTG-84, RUTG-64 DV and DVL models*
- **RTG20248 - Recess Box for Stucco Applications**
For the RUTG-64XL, RUTG-84XL, and RUTG-95XL models*
Rough in Dimensions: 42" High, 14-1/2" Wide, 8-1/2" Deep
*Kits also applicable to models with "-1"

Maximum Comfort

Recirculation Pump Kit (Timer Based)

For use with RUTGH-84DVLN/XN-1, RUTGH-90DVLN/XN-1, RUTGH-95DVLN/XN-1, RUTG-64DVLN/XN-1, RUTG-84DVLN/XN-1 and RUTG-95DVLN/XN-1



- **AP17920**
Kit contains: 1) Taco® 0015 recirculation pump with internal check valve, (2) Stainless steel flanges and flange gaskets, (4) 7/16"-14 Bolts and nuts, and (1) Installation instruction sheet

Maintenance and Service



Tankless Service Valves
Allow for easy maintenance and service, such as flushing, for your tankless water heater.

- **RTG20220AB**
Webstone service valves, clean brass for low lead code, includes relief valve



AllClear™ Water Treatment System
Combat hard water and scale build up

- **RTG20251**
AllClear™ Water Treatment System
- **RTG20252**
Replacement Cartridge



Tankless Flush Kit
Connects easily to tankless service valves. Allows for the flushing the heat exchanger with a cleaning solution such as white vinegar. Simple to use.

- **RTG20124**
Includes: 5-gallon bucket, submersible pump, and two hoses



Pressure Relief Valve
Provides protection against excessive water pressure for your tankless water heater.

- **AP12993C**
Watts pressure relief valve, Rated at 150psi – 3/4" threads

Remote Control Options

Tankless Remote Controls
Allow for easy temperature adjustment and maintenance information access. Connect up to 3 remote controls, one of each type, to your tankless system.



- **RTG20006DW**
UMC-117 Main Remote Control, Generic without branding
- **RTG20006DU**
USC1-117 Bath Remote Control, Generic without branding
- **RTG20006DV**
USC2-117 Second Bath Remote Control, Generic without branding
- **RTG20009-1**
10-ft. Thermostat Wire, 1 pair 18AWG

Tankless Manifold Systems

EZ-Link™: Connect two tankless water heaters

EZ-Link™ Cable

Connect two tankless water heaters together in a manifold*** †
This will allow two heaters to communicate together and operate as a single unit. Perfect for when one tankless is just not enough.

- RTG20040
6-ft. Long Cable with Connectors, and Wire Support Clamps.

*** Only two units may be connected together with the EZ-Link™ cable.
† Only Identical models: all RUTG-95, RUTG-84, RUTG-64, RUTGH-84, RUTGH-90, and RUTGH-95 models can be used with the EZ-Link Cable.



MIC-6 Manifold Controller System

Connect up to 6 tankless water heaters

MIC-6 Manifold Controller System

For the RUTGH-95, RUTGH-84, RUTGH-90, RUTG-95, RUTG-84, and RUTG-64 series models only.
Connect up to 6 tankless water heaters together in a manifold. This kit mounts inside a single tankless unit and connects to up to 5 additional units for a total of 6.

Notice: This kit will not work on any model manufactured before Jan 2010.

- RTG20213A
Connect up to 6 tankless water heaters together in a manifold.
Includes (1) 1-ft. control cable, and (1) 6-ft. control cable. Additional Type Q cables are necessary and listed below.

Manifold Control Cables (Type Q)

One required for each tankless water heater installed in a manifold. Connects a single tankless water heater to the MIC-6.

Notice: These cables will not fit the MIC-185 System.

- RTG20213B - MIC-Q-1 1-ft. Control Cable
- RTG20213C - MIC-Q-6 6-ft. Control Cable
- RTG20213D - MIC-Q-18 18-ft. Control Cable

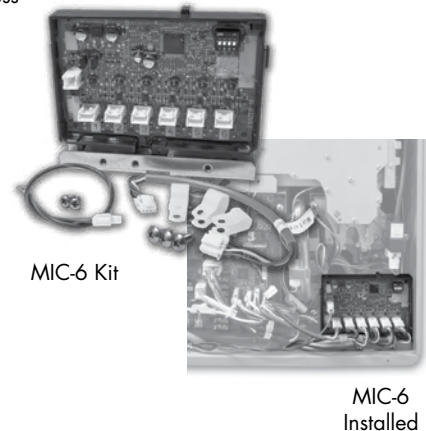

MIC-185 Manifold Controller System

Connect up to 20 tankless water heaters



MIC-185 Manifold Controller System

- RTG20126A
Manifold and control up to 6 tankless models.*
Includes installation cabinet for indoor or outdoor applications.

MICS-180 Manifold Controller Expansion Card

- RTG20126B
Add on to the MIC-185 for up to 20 units in total.**
Installations of 7 to 20 units require this expansion card.
Mounts inside the MIC-185 cabinet. Includes cables to connect to the MIC-185 board.

Replacement Manifold Control Board

- RTG20126W - MIC-185 Board
Replacement board for the MIC-180 or MIC-185.

Manifold Control Cables (Type K)

One required for each tankless water heater installed in a manifold. Connects a single tankless water heater to the MIC-180.

Notice: These cables will not fit the MIC-6.

- RTG20126C - MIC-K-16
16-ft. Control Cable
- RTG20126D - MIC-K-32
32-ft. Control Cable
- RTG20126E - MIC-K-65
65-ft. Control Cable



* All RUTG-95, RUTG-84, RUTG-64, RUTGH-84, RUTGH-90 and RUTGH-95 models.
Commercial upgraded models will be limited to 185°F in a manifold system. Residential models are limited to 140°F.
** This card provides control cable connection points for 7 - 20 units in multi-unit manifold.

Tankless Venting

PVC Termination Kits

for RUTGH-84DV, RUTGH-90DV and RUTGH-95DV



Horizontal Vent Termination

- SP20286 for 3" PVC
PTX-129
- SP20285 for 2" PVC
RXGY-G02

11-3/4" Wide, 8" Tall, 2-1/2" Deep
Fits PVC, ABS piping. Offers a clean installation of the intake and exhaust pipes of the condensing tankless water heater.



Horizontal or Vertical
Concentric Vent Termination

- SP20245 for 3" PVC
RXGY-E03A

39" Long, 7-1/4" Diameter, 4-1/2" opening required. Fits PVC, ABS piping. Offers a clean installation by combining the intake and exhaust pipes of the condensing tankless water heater into a single concentric vent termination.

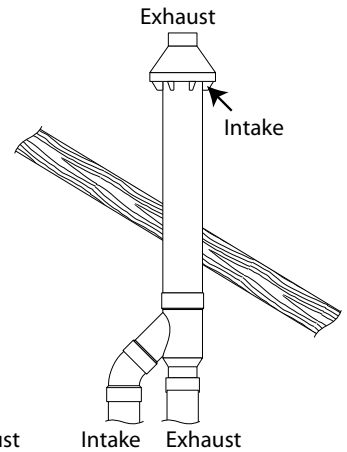
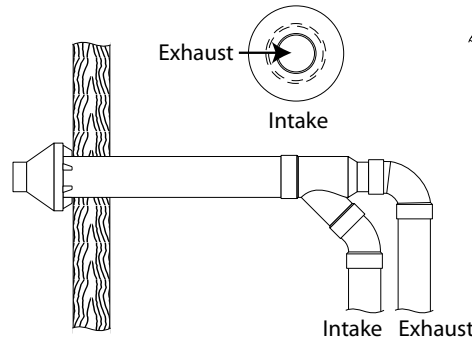
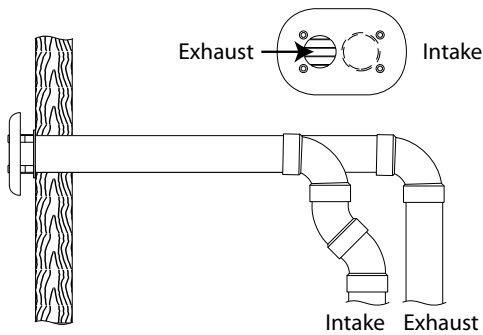

3"/5" Stainless Steel Concentric Vent Kits by Metal Fab, Inc.

for RUTG-64DVL, RUTG-84DVL and RUTG-95DVL models

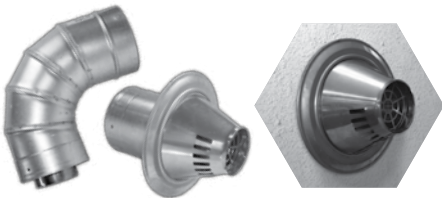

Low-Profile Horizontal
Vent Termination Kit by
Metal Fab, Inc.

- RTG20231
Contains: 90-Degree Elbow, Short Low-Profile Termination, Screws. For 2" x 4" Wall with 1-1/2" Siding. For up to 6" walls. Can be extended. MF3CGVPHK3
- RTG20234
Contains: 90-Degree Elbow, Short Low-Profile Termination, Screws. For 2" x 6" Wall with 1-1/2" Siding. For up to 8" walls. Can be extended. MF3CGVPHK4
- RTG20257
Contains: 90-Degree Elbow, Short Low-Profile Termination, Trim Ring, Screws. For up to 10" walls. Can be extended.

- RTG20258
Contains: 90-Degree Elbow, Short Low-Profile Termination, Trim Ring, Screws. For up to 12" walls. Can be extended.
- RTG20230
4" Short Low-Profile Termination
- RTG20233
6" Long Low-Profile Termination
- RTG20259
8" Long Low-Profile Termination
- RTG20260
10" Long Low-Profile Termination



Horizontal Vent
Termination Kit by Metal
Fab, Inc.

- RTG20210
Contains: 94-Degree Elbow, Long Termination, (1) 12" Wall Plate, Screws. For up to 10" walls. Can be extended. MF3CGVPHK1



Vertical Vent Termination
Kit by Metal Fab, Inc.

- RTG20211
Contains: Storm Collar, 6/12 to 12/12 Pitched Cone Flashing, Vertical Termination with Rain Cap. Does not include vertical vent pipe. MF3CGVVK1

Tankless Venting

3"/5" Stainless Steel Concentric Tankless Venting by Metal Fab, Inc.

for RUTG-64DV, RUTG-84DV and RUTG-95DV models

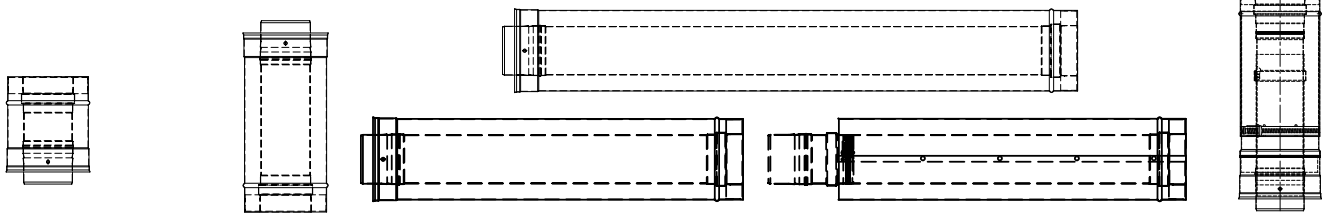

6" Vent Length
• RTG20151W
5.66" overall length
MF3CGV6

12" Vent Length
• RTG20151R
11.66" overall length
MF3CGV12

24" Vent Length
• RTG20151C-1
23.66" overall length
MF3CGV24

36" Vent Length
• RTG20151D-1
35.66" overall length
MF3CGV36

Adjustable Vent Length
• RTG20151E-1
7.5" to 22" overall length
MF3GVL22

Adjustable Vent Length
• RTG20151Y
13" to 20" overall length
MF3CGVVAL20

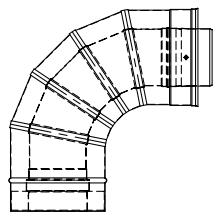

90-Degree Elbow
• RTG20151A-1
8.1" rise - 8.1" run
MF3CGV90L

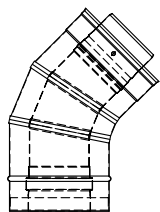

45-Degree Elbow
• RTG20151B-1
8.6" rise - 3" run
MF3CGV45L

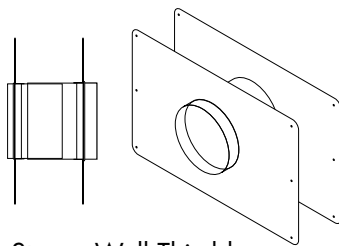

Stucco Wall Thimble
• RTG20151Z
17" Wide - 12" Tall
Up to 6" Deep Wall with
Drywall and Stucco Rings
MF3CGVWPKS

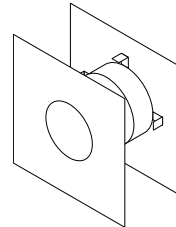

Wall Thimble
• RTG20151X
12" Square, Up to
8" Deep Wall
MF3CGVWPK

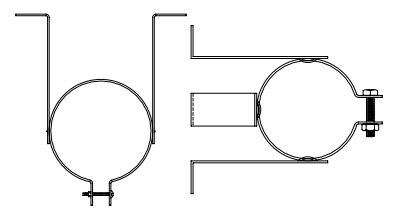

Wall Hanger
• RTG20151H
2-point pivot
mounting
MF3CGVWH1

Wall Support
• RTG20151G
3-point
mounting
MF3CGVWS1

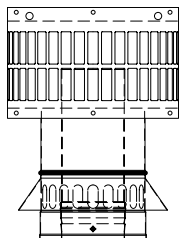

Vertical Cap Termination
• RTG20151P
12" overall height
MF3CGVPVT



Storm Collar
• RTG20151M-1
split ring
galvanized
MF3CGVSC

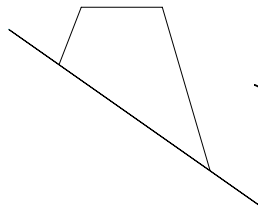

6/12 to 12/12
Roof Flashing
• RTG20151L-1
15" square base
galvanized
MF3CGVF-12

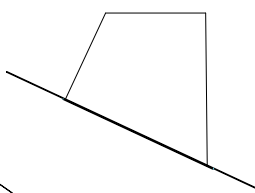

2/12 to 5/12
Roof Flashing
• RTG20151K-1
15" square base
galvanized
MF3CGVF

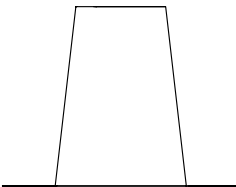

Tall Cone
Roof Flashing
• RTG20151J-1
15" square base
galvanized
MF3CGVFT

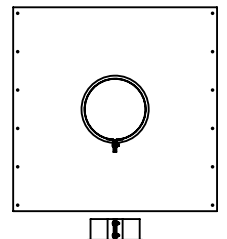

Support Plate
• RTG20151T
17" square base
support/fire stop
MF3CGVPS

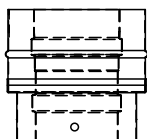

Appliance Adapter
• RTG20144-3
Fits RUTG-66 or 53DV
5" overall length
MF3CGVPA

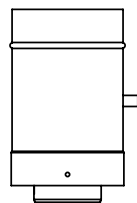

Condensate Drain
• RTG20151S
horizontal and vertical
8.6" overall length
MF3CGVSDS

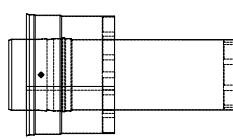

Horizontal Termination
• RTG20128-2
Short for 4" inch wall
horizontal only
MF3CGVPHT

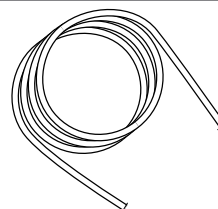

Silicone Condensate
Drain Tube Kit
• RTG20150A
6' high temperature
silicone tube, 2 clamps,
2 wire ties, instructions

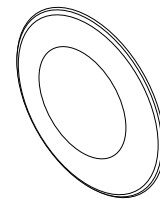

Trim Ring
• RTG20151AA
Indoor/Outdoor
8.9" Dia - 5.25"
Hole - Galv
MF3CGTR

NOTICE:
The components listed on this page are manufactured by Metal Fab, Inc. and are not compatible with venting components manufactured by Heat-Fab listed in previous versions in the Tankless Parts and Accessories Catalog, or any other brand of venting. Make no attempt to use venting components manufactured by different companies on a single installation.

Parts for RUTGH-84DVLN-1, RUTGH-90DVLN-1, RUTGH-95DVLN-1 Series

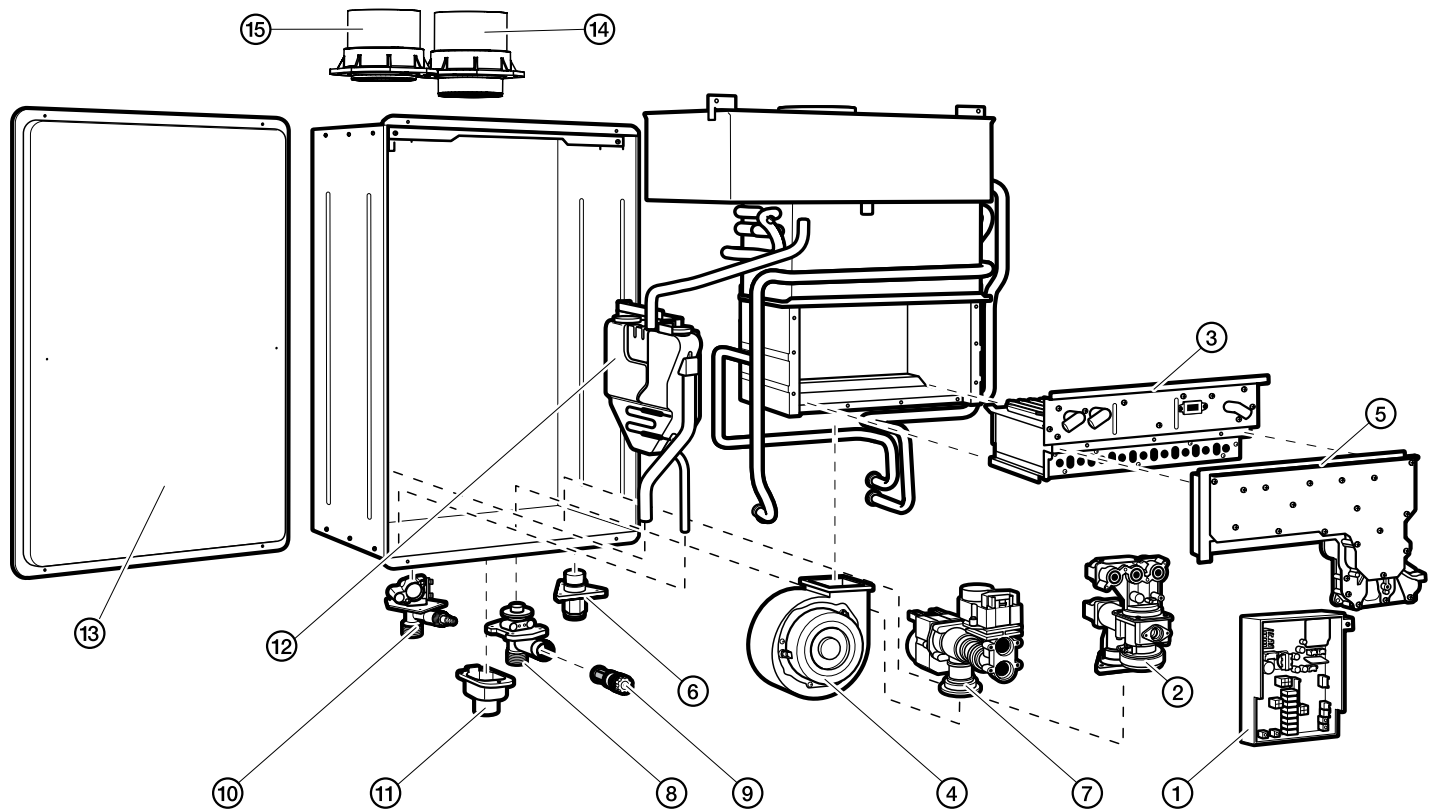

Program Chips

Fuel Type	RUTGH-84DVLN-1	RUTGH-90DVLN-1	RUTGH-95DVLN-1
Natural	RTG20239AJ	RTG20239AN	RTG20239AE
Propane	RTG20239AK	RTG20239AP	RTG20239AF

185°F Temperature Upgrade Kits - Commercial and Hydronic

Fuel Type	RUTGH-84DVLN-1	RUTGH-90DVLN-1	RUTGH-95DVLN-1
Natural	RTG20256A	RTG20255A	RTG20254A
Propane	RTG20256B	RTG20255B	RTG20254B

Accessories

Venting	SP20286 (PTX-129) 3" Horizontal Termination Kit
	SP20285 (RXGY-G02) 2" Horizontal Termination Kit
	SP20245 (RXGY-E03A) 3" Concentric Horizontal/Vertical Termination Kit
Remote Controls	RTG20006DW UMC-117 Main Remote Control
	RTG20006DU USC1-117 Bath Remote Control
	RTG20006DV USC2-117 Second Bath Remote Control
Pipe Covers	RTG20227 Pipe Cover (grey)
Service Valves	RTG20220 Tankless Service Valve Kit with Relief Valve
	RTG20220AB Tankless Service Valve Kit with Relief Valve - California Code
Relief Valve	AP12993C Pressure Relief Valve
EZ-Link™ Cable	RTG20040 6-ft. EZ-Link™ Cable

Parts for RUTGH-84DVLN-1, RUTGH-90DVLN-1, RUTGH-95DVLN-1 Series

Ref #	Ruud Part #	Description	RUTGH-84DVLN-1	RUTGH-90DVLN-1	RUTGH-95DVLN-1
1	RTG20239AC	Control Board	•	•	•
	RTG20006AR	Inlet Thermistor - White	•	•	•
	RTG20212BC	Heat Exchanger Thermistor - Yellow	•	•	•
	RTG20006BB	Outlet Thermistor - Black	•	•	•
	RTG20006UW	Ambient Thermistor - Blue	•	•	•
	RTG20223L	Vent High Temperature Limit Switch	•	•	•
	RTG20239M	Thermistor Wiring Harness	•	•	•
2	RTG20239AY	Gas Control Valve	•	•	•
	RTG20239AD	Gas Control Wiring Harness	•	•	•
3	RTG20235AD	Burner Assembly	•	•	•
	RTG20235C	Igniter Coil	•	•	•
	RTG20212BD	Igniter Rod (IG) (with gasket)	•	•	•
4	RTG20212K	Blower Motor	•	•	•
	RTG20223K	Blower Case	•	•	•
5	RTG20235W	Burner Manifold - LP	•	•	•
5	RTG20239AA	Burner Manifold NAT	•	•	•
	RTG20212BE	Flame Rod FL-1 (with gasket)	•	•	•
	RTG20235AX	Flame Rod Wire (White)	•	•	•
	RTG20212BF	Flame Rod FL-2 (with gasket)	•	•	•
	RTG20223M	Flame Rod Wire (Blue)	•	•	•
6	RTG20164K	Gas Inlet Connector ¾"	•	•	•
7	RTG20164L	Water Control Valve	•	•	•
	RTG20235X	Bypass Assembly	•	•	•
8	RTG20164J	Water Inlet Connector ¾"	•	•	•
9	RTG20164AK	Inlet Water Filter	•	•	•
10	RTG20074CE	Hot Water Outlet Connector ¾"	•	•	•
11	RTG20164AA	Remote Control Terminal Block	•	•	•
	RTG20212U	Remote Control Terminal	•	•	•
12	RTG20239AX	Neutralization Replacement Kit	•	•	•
13	RTG20239Z	Front Cover - No Labels or Branding	•	•	•
14	RTG20223Y	Exhaust Vent Outlet Connector - PVC	•	•	•
15	RTG20223X	Air Intake Inlet Connector - PVC	•	•	•
	RTG20074EH	Gas Shutoff Valve ¾"	•	•	•
	RTG20186	Replacement Screw Kit	•	•	•
	RTG20206	Replacement O-Ring Kit	•	•	•
	RTG20235AB	Thermostat Assembly	•	•	•

See Pages 6 - 9 for additional Accessories, Manifold Systems, and Venting Options.

Parts for RUTGH-84XLN-1, RUTGH-90XLN-1, RUTGH-95XLN-1 Series

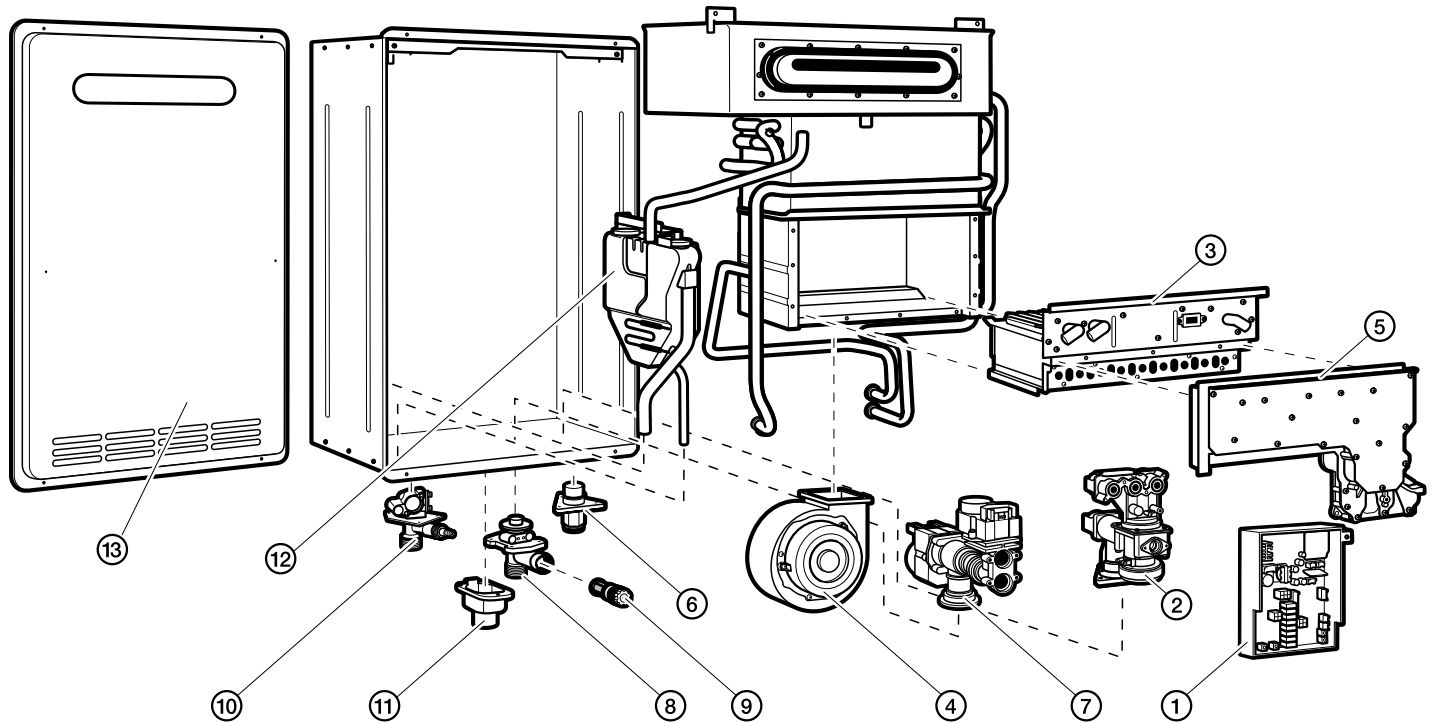

Program Chips

Fuel Type	RUTGH-84XLN-1	RUTGH-90XLN-1	RUTGH-95XLN-1
Natural	RTG20239AL	RTG20239AR	RTG20239AG
Propane	RTG20239AM	RTG20239AS	RTG20239AH

185°F Temperature Upgrade Kits - Commercial and Hydronic

Fuel Type	RUTGH-84XLN-1	RUTGH-90XLN-1	RUTGH-95XLN-1
Natural	RTG20256C	RTG20255C	RTG20254C
Propane	RTG20256D	RTG20255D	RTG20254D

Accessories

Remote Controls

RTG20006DW UMC-117 Main Remote Control
 RTG20006DU USC1-117 Bath Remote Control
 RTG20006DV USC2-117 Second Bath Remote Control

Pipe Covers

RTG20227 Pipe Cover (grey)

Recess Box

RTG20226 Recess Box (grey)

Service Valves

RTG20220 Tankless Service Valve Kit with Relief Valve
 RTG20220AB Tankless Service Valve Kit with Relief Valve - California Code

Relief Valve

AP12993C Pressure Relief Valve

EZ-link™ Cable

RTG20040 6-ft. EZ-Link™ Cable

Parts for RUTGH-84XLN-1, RUTGH-90XLN-1, RUTGH-95XLN-1 Series

Ref #	Ruud Part #	Description	RUTGH-84XLN-1	RUTGH-90XLN-1	RUTGH-95XLN-1
1	RTG20239AC	Control Board	•	•	•
	RTG20006AR	Inlet Thermistor - White	•	•	•
	RTG20212BC	Heat Exchanger Thermistor - Yellow	•	•	•
	RTG20006BB	Outlet Thermistor - Black	•	•	•
	RTG20006UW	Ambient Thermistor - Blue	•	•	•
	RTG20239M	Thermistor Wiring Harness	•	•	•
2	RTG20239AY	Gas Control Valve	•	•	•
	RTG20239AD	Gas Control Wiring Harness	•	•	•
3	RTG20235U	Burner Assembly	•	•	•
	RTG20235C	Igniter Coil	•	•	•
	RTG20212BD	Igniter Rod (IG) (with gasket)	•	•	•
4	RTG20212AB	Blower Motor	•	•	•
	RTG20212AC	Blower Case	•	•	•
5	RTG20235W	Burner Manifold - LP	•	•	•
5	RTG20239A	Burner Manifold NAT	•	•	•
	RTG20212BE	Flame Rod FL-1 (with gasket)	•	•	•
	RTG20235AX	Flame Rod Wire (White)	•	•	•
6	RTG20164K	Gas Inlet Connector 3/4"	•	•	•
7	RTG20164L	Water Control Valve	•	•	•
	RTG20235X	Bypass Assembly	•	•	•
8	RTG20164J	Water Inlet Connector 3/4"	•	•	•
9	RTG20164AK	Inlet Water Filter	•	•	•
10	RTG20074CE	Hot Water Outlet Connector 3/4"	•	•	•
	RTG20006AV	Drain Plug with Relief	•	•	•
11	RTG20164AA	Remote Control Terminal Block	•	•	•
	RTG20212U	Remote Control Terminal	•	•	•
12	RTG20239AX	Neutralization Replacement Kit	•	•	•
13	RTG20239Y	Front Cover - No Labels or Branding	•	•	•
	RTG20074EH	Gas Shutoff Valve 3/4"	•	•	•
	RTG20186	Replacement Screw Kit	•	•	•
	RTG20206	Replacement O-Ring Kit	•	•	•
	RTG20235AB	Thermostat Assembly	•	•	•

See Pages 6 - 9 for additional Accessories, Manifold Systems, and Venting Options.

Parts for RUTG-64DVLN-1, RUTG-84DVLN-1, RUTG-95DVLN-1 Series

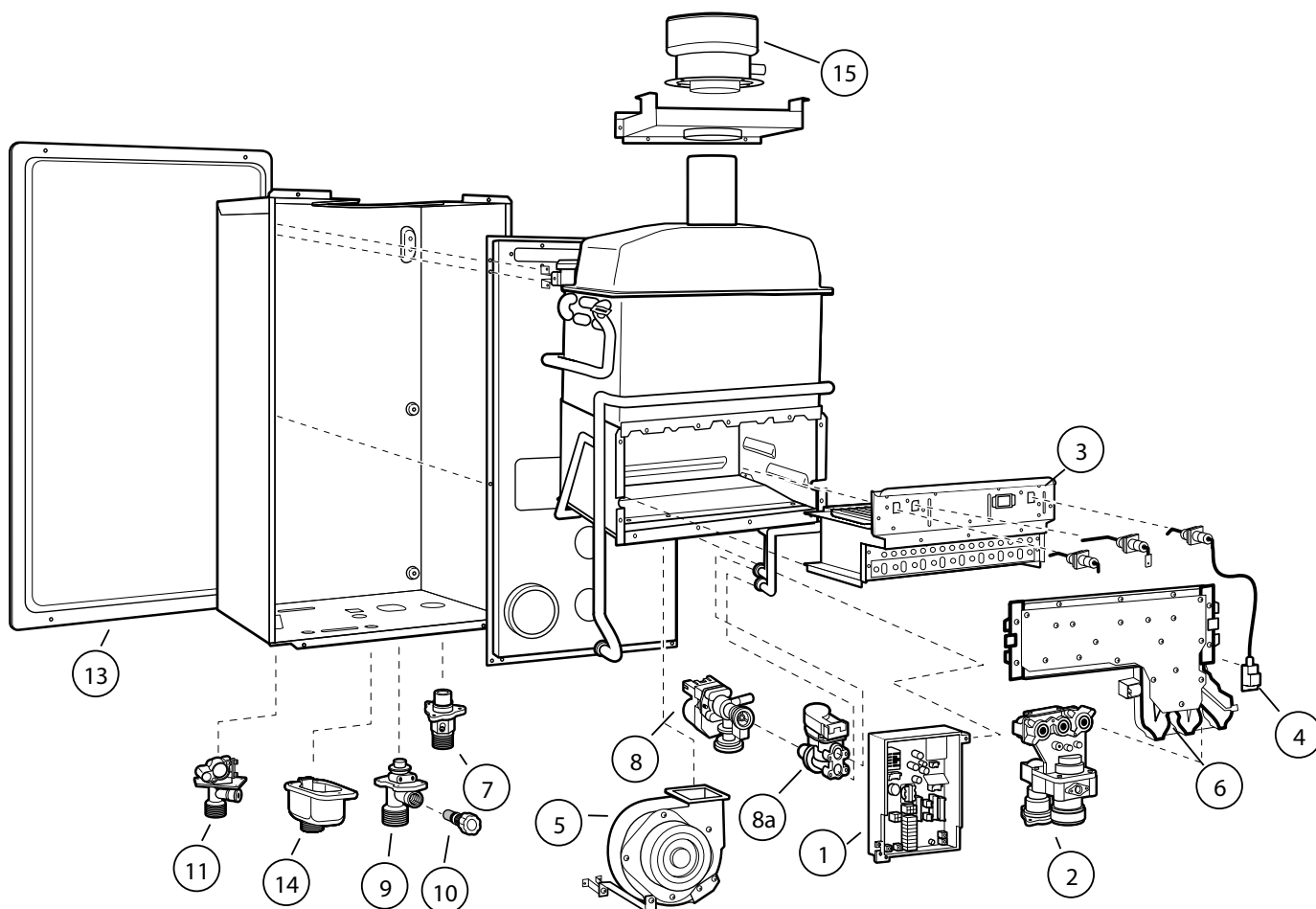

Program Chips

Fuel Type	RUTG-64DVLN-1	RUTG-84DVLN-1	RUTG-95DVLN-1
Natural	RTG20235AN	RTG20235AJ	RTG20235AE
Propane	RTG20235AP	RTG20235AK	RTG20235AF

185°F Temperature Upgrade Kits - Commercial and Hydronic

Fuel Type	RUTG-64DVLN-1	RUTG-84DVLN-1	RUTG-95DVLN-1
Natural	-	RTG20250A	RTG20249A
Propane	-	RTG20250B	RTG20249B

Accessories

Remote Controls

RTG20006DW UMC-117 Main Remote Control
 RTG20006DU USC1-117 Bath Remote Control
 RTG20006DV USC2-117 Second Bath Remote Control

Pipe Covers

RTG20217DVG Pipe Cover (grey)

Service Valves

RTG20220 Tankless Service Valve Kit with Relief Valve
 RTG20220AB Tankless Service Valve Kit with Relief Valve - California Code

Relief Valve

AP12993C Pressure Relief Valve

EZ-Link™ Cable

RTG20040 6-ft. EZ-Link™ Cable

Parts for RUTG-64DVLN-1, RUTG-84DVLN-1, RUTG-95DVLN-1 Series

Ref #	Ruud Part #	Description	RUTG-64DVLN-1	RUTG-84DVLN-1	RUTG-95DVLN-1
1	RTG20235Y	Control Board	•	•	•
	RTG20006UW	Ambient Thermistor - Blue	•	•	•
	RTG20212BC	Heat Exchanger Thermistor - Yellow	•	•	•
	RTG20006AR	Inlet Thermistor - White	•	•	•
	RTG20006BB	Outlet Thermistor - Black	•	•	•
	RTG20239M	Thermistor Wiring Harness	•	•	•
2	RTG20235AC	Gas Valve Assy	•	•	•
3	RTG20235AD	Burner Assembly	•	•	•
6	RTG20235V	Burner Manifold - NAT	•	•	•
6	RTG20235W	Burner Manifold - LP	•	•	•
	RTG20212BE	Flame Rod "FL1" (Right) w/gasket	•	•	•
	RTG20212J	Gas Control Resistor	•	•	•
	RTG20212BF	Flame Rod "Sensor" (Left) w/gasket	•	•	•
	RTG20212N	Flame Rod Wire (Blue)	•	•	•
	RTG20235AX	Flame Rod Wire (White)	•	•	•
4	RTG20235C	Igniter Coil	•	•	•
	RTG20212BD	Igniter Rod (Right) w/gasket	•	•	•
5	RTG20212K	Blower Motor	•	•	•
	RTG20212L	Blower Case	•	•	•
7	RTG20164K	Gas Inlet Connector 3/4"	•	•	•
8	RTG20164L	Water Control Valve	•	•	•
8a	RTG20235X	Water Bypass Valve	•	•	•
9	RTG20164J	Water Inlet Connector 3/4"	•	•	•
11	RTG20074CE	Hot Water Outlet Connector 3/4"	•	•	•
14	RTG20212U	Remote Control Terminal	•	•	•
	RTG20164AA	Remote Control Terminal Block	•	•	•
	RTG20006AV	Drain Plug with Relief	•	•	•
	RTG20212A	Top Mounting Bracket	•	•	•
	RTG20212B	Bottom Mounting Bracket	•	•	•
	RTG20164AB	Screw Pan FT 4X12	•	•	•
10	RTG20164AK	Inlet Water Filter	•	•	•
13	RTG20235AU	Front Cover - No Labels or Branding	•	•	•
15	RTG20212BB	Concentric Vent Connector Assembly	•	•	•
	RTG20074EH	Gas Shutoff Valve 3/4"	•	•	•
	RTG20186	Replacement Screw Kit	•	•	•
	RTG20206	Replacement O-Ring Kit	•	•	•
	RTG20235AB	Thermostat Assembly	•	•	•

See Pages 6 - 9 for additional Accessories, Manifold Systems, and Venting Options.

Parts for RUTG-64XLN-1, RUTG-84XLN-1, RUTG-95XLN-1 Series

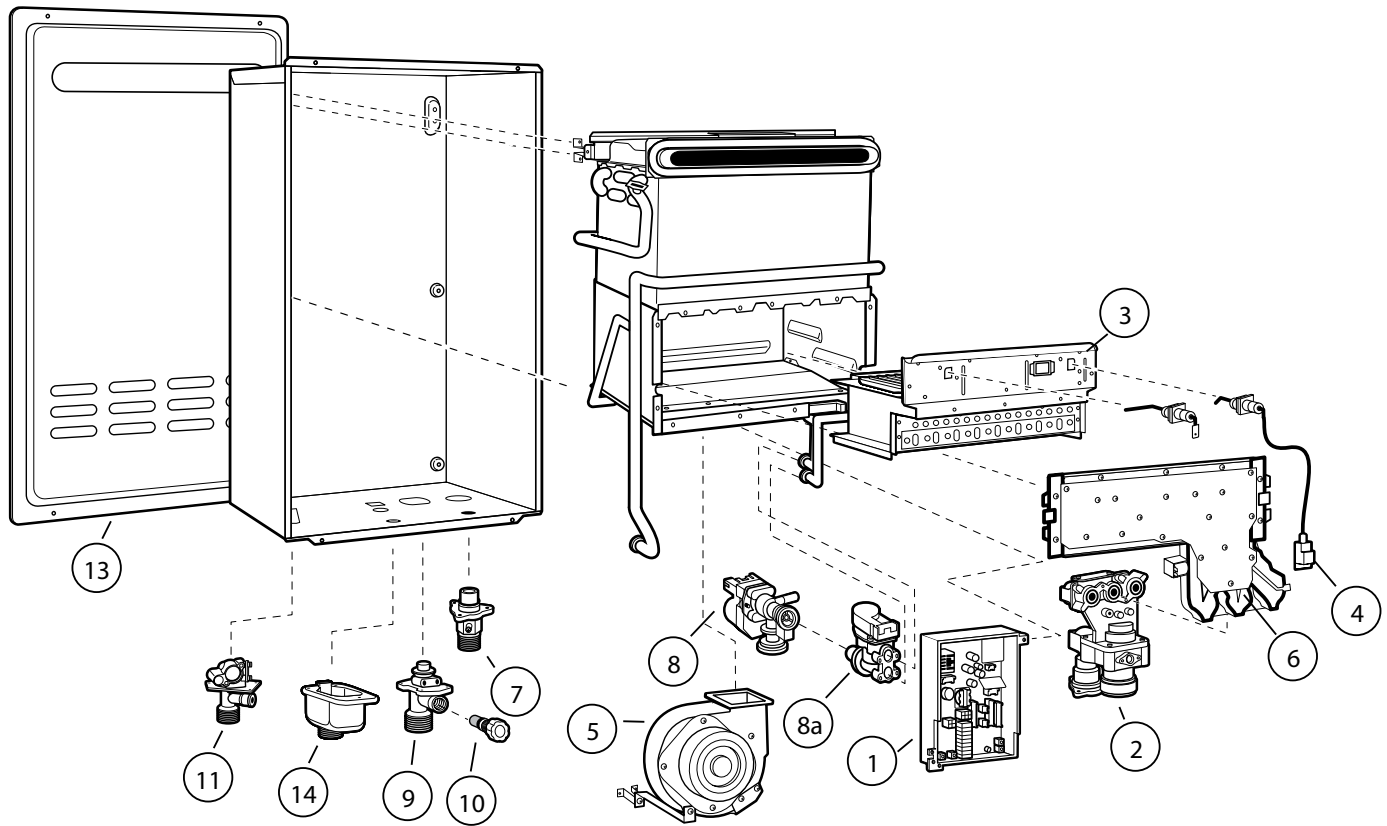

Program Chips

Fuel Type	RUTG-64XLN-1	RUTG-84XLN-1	RUTG-95XLN-1
Natural	RTG20235AR	RTG20235AL	RTG20235AG
Propane	RTG20235AS	RTG20235AM	RTG20235AH

185°F Temperature Upgrade Kits - Commercial and Hydronic

Fuel Type	RUTG-64XLN-1	RUTG-84XLN-1	RUTG-95XLN-1
Natural	-	RTG20250C	RTG20249C
Propane	-	RTG20250D	RTG20249D

Accessories

Remote Controls

RTG20006DW UMC-117 Main Remote Control
 RTG20006DU USC1-117 Bath Remote Control
 RTG20006DV USC2-117 Second Bath Remote Control

Pipe Covers

RTG20217XG Pipe Cover (grey)

Recess Box

RTG20218 Recess Box (grey)

Service Valves

RTG20220 Tankless Service Valve Kit with Relief Valve
 RTG20220AB Tankless Service Valve Kit with Relief Valve - California Code

Relief Valve

AP12993C Pressure Relief Valve

EZ-Link™ Cable

RTG20040 6-ft. EZ-Link™ Cable

Parts for RUTG-64XLN-1, RUTG-84XLN-1, RUTG-95XLN-1 Series

Ref #	Ruud Part #	Description	RUTG-64XLN-1	RUTG-84XLN-1	RUTG-95XLN-1
1	RTG20235Y	Control Board	•	•	•
	RTG20212BC	Heat Exchanger Thermistor - Yellow	•	•	•
	RTG20006BB	Outlet Thermistor - Black	•	•	•
	RTG20006AR	Inlet Thermistor - White	•	•	•
	RTG20006UW	Ambient Thermistor - Blue	•	•	•
	RTG20239M	Thermistor Wiring Harness	•	•	•
2	RTG20235T	Gas Valve Assy	•	•	•
	RTG20212J	Gas Control Resister	•	•	•
3	RTG20235U	Burner Assembly	•	•	•
	RTG20212BE	Flame Rod "FL" (Right) w/gasket	•	•	•
	RTG20212BD	Igniter Rod (Right) w/gasket	•	•	•
	RTG20235AX	Flame Rod Connector (White)	•	•	•
4	RTG20235C	Igniter Coil	•	•	•
5	RTG20212AB	Blower Motor	•	•	•
	RTG20212AC	Blower Case	•	•	•
6	RTG20235V	Burner Manifold - NAT	•	•	•
6	RTG20235W	Burner Manifold - LP	•	•	•
7	RTG20164K	Gas Inlet Connector 3/4"	•	•	•
8	RTG20164L	Water Control Valve	•	•	•
8a	RTG20235X	Water Bypass Valve	•	•	•
9	RTG20164J	Water Inlet Connector 3/4"	•	•	•
	RTG20006AV	Drain Plug with Relief	•	•	•
11	RTG20074CE	Hot Water Outlet Connector 3/4"	•	•	•
	RTG20164AA	Remote Control Terminal Block	•	•	•
	RTG20164AB	Screw Pan FT 4X12	•	•	•
10	RTG20164AK	Inlet Water Filter	•	•	•
13	RTG20235AT	Front Cover - No Labels or Branding	•	•	•
	RTG20074EH	Gas Shutoff Valve 3/4"	•	•	•
	RTG20186	Replacement Screw Kit	•	•	•
	RTG20206	Replacement O-Ring Kit	•	•	•
	RTG20235AB	Thermostat Assembly	•	•	•

See Pages 6 - 9 for additional Accessories, Manifold Systems, and Venting Options.

Parts for RUTGH-84, RUTGH-90, RUTGH-95 DV and DVL Series

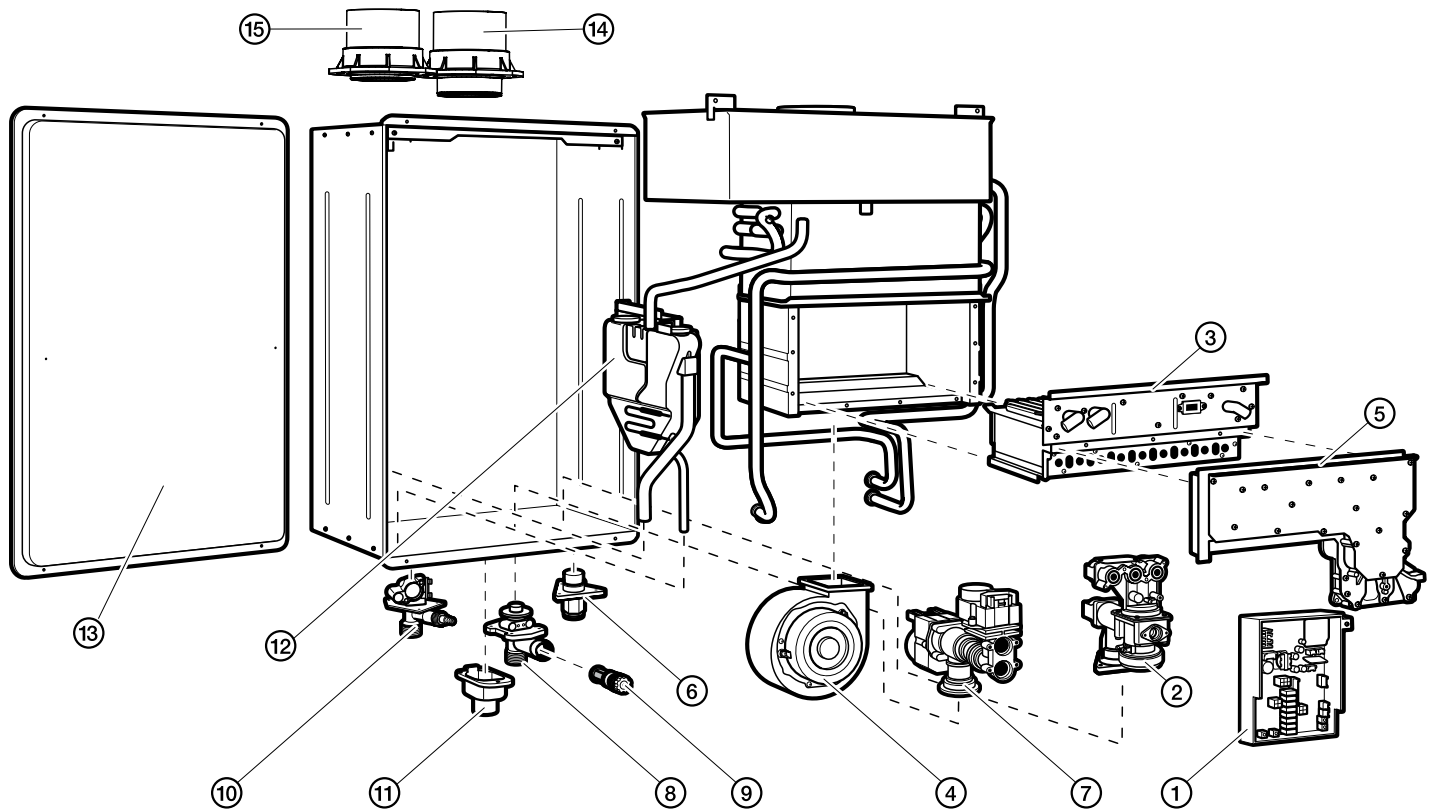

Program Chips

Fuel Type	RUTGH-84DV	RUTGH-95DV	RUTGH-84DVL	RUTGH-90DVL	RUTGH-95DVL
Natural	RTG20228T	RTG20228N	RTG20239G	RTG20239P	RTG20239C
Propane	RTG20228U	RTG20228P	RTG20239H	RTG20239R	RTG20239D

185°F Temp. Upgrade Kits - Commercial and Hydronic

Fuel Type	RUTGH-84DV	RUTGH-95DV	RUTGH-84DVL	RUTGH-90DVL	RUTGH-95DVL
Natural	RTG20225A	RTG20224A	RTG20241A	RTG20244A	RTG20240A
Propane	RTG20225B	RTG20224B	RTG20241B	RTG20244B	RTG20240B

Accessories

Venting	SP20286 (RXGY-G01) 3" Horizontal Termination Kit
	SP20285 (RXGY-G02) 2" Horizontal Termination Kit
	SP20245 (RXGY-E03A) 3" Concentric Horizontal/Vertical Termination Kit
Remote Controls	RTG20006DW UMC-117 Main Remote Control
	RTG20006DU USC1-117 Bath Remote Control
	RTG20006DV USC2-117 Second Bath Remote Control
Pipe Covers	RTG20227 Pipe Cover (grey)
Service Valves	RTG20220 Tankless Service Valve Kit with Relief Valve
	RTG20220AB Tankless Service Valve Kit with Relief Valve - California Code
Relief Valve	AP12993C Pressure Relief Valve
EZ-Link™ Cable	RTG20040 6-ft. EZ-Link™ Cable

Parts for RUTGH-84, RUTGH-90, RUTGH-95 DV and DVL Series

Ref #	Ruud Part #	Description	RUTGH-84DV	RUTGH-95DV	RUTGH-84DVL	RUTGH-90DVL	RUTGH-95DVL
1	RTG20223P	Control Board	•	•			
1	RTG20239B	Control Board			•	•	•
	RTG20223D	Inlet Thermistor - White	•	•			
	RTG20006AR	Inlet Thermistor - White			•	•	•
	RTG20223G	Heat Exchanger Thermistor - Green	•	•			
	RTG20212BC	Heat Exchanger Thermistor - Yellow			•	•	•
	RTG20223H	Outlet Thermistor - Black	•	•			
	RTG20006BB	Outlet Thermistor - Black			•	•	•
	RTG20223J	Ambient Thermistor - Blue	•	•			
	RTG20006UW	Ambient Thermistor - Blue			•	•	•
	RTG20223L	Vent High Temperature Limit Switch	•	•	•	•	•
	RTG20223W	Thermistor Wiring Harness	•	•			
	RTG20239M	Thermistor Wiring Harness			•	•	•
2	RTG20212V	Gas Control Valve	•	•	•	•	•
	RTG20223V	Gas Control Wiring Harness	•	•			
	RTG20239L	Gas Control Wiring Harness			•	•	•
3	RTG20212D	Burner Assembly	•	•	•	•	•
	RTG20235C	Igniter Coil	•	•	•	•	•
	RTG20212BD	Igniter Rod (IG) (with gasket)	•	•	•	•	•
4	RTG20212K	Blower Motor	•	•	•	•	•
	RTG20223K	Blower Case	•	•	•	•	•
5	RTG20212F	Burner Manifold LP	•	•			
5	RTG20235B	Burner Manifold - LP			•	•	•
5	RTG20212X	Burner Manifold NAT	•	•			
5	RTG20239A	Burner Manifold NAT			•	•	•
	RTG20212BE	Flame Rod FL-1 (with gasket)	•	•	•	•	•
	RTG20212P	Flame Rod Wire (White)	•	•	•	•	•
	RTG20212BF	Flame Rod FL-2 (with gasket)	•	•	•	•	•
	RTG20223M	Flame Rod Wire (Blue)	•	•	•	•	•
6	RTG20164K	Gas Inlet Connector 3/4"	•	•	•	•	•
7	RTG20223E	Water Control Valve	•	•			
	RTG20164L	Water Control Valve			•	•	•
	RTG20164M	Bypass Assembly	•	•	•	•	•
8	RTG20164J	Water Inlet Connector 3/4"	•	•	•	•	•
9	RTG20164AK	Inlet Water Filter	•	•	•	•	•
10	RTG20074CE	Hot Water Outlet Connector 3/4"	•	•	•	•	•
11	RTG20164AA	Remote Control Terminal Block	•	•	•	•	•
	RTG20212U	Remote Control Terminal	•	•	•	•	•
12	RTG20223F	Neutralization Replacement Kit	•	•			
	RTG20239N	Neutralization Replacement Kit			•	•	•
13	RTG20223B	Front Cover - No Labels or Branding	•	•	•	•	•
14	RTG20223Y	Exhaust Vent Outlet Connector - PVC	•	•	•	•	•
15	RTG20223X	Air Intake Inlet Connector - PVC	•	•	•	•	•
	RTG20074EH	Gas Shutoff Valve 3/4"	•	•	•	•	•
	RTG20186	Replacement Screw Kit	•	•	•	•	•
	RTG20206	Replacement O-Ring Kit	•	•	•	•	•

See Pages 6 - 9 for additional Accessories, Manifold Systems, and Venting Options.

Parts for RUTGH-84, RUTGH-90, RUTGH-95 X and XL Series

Ref #	Ruud Part #	Description	RUTGH-84X	RUTGH-95X	RUTGH-84XL	RUTGH-90XL	RUTGH-95XL
1	RTG20223P	Control Board	•	•			
	RTG20239B	Control Board			•	•	•
	RTG20223D	Inlet Thermistor - White	•	•			
	RTG20006AR	Inlet Thermistor - White			•	•	•
	RTG20223G	Heat Exchanger Thermistor - Green	•	•			
	RTG20212BC	Heat Exchanger Thermistor - Yellow			•	•	•
	RTG20223H	Outlet Thermistor - Black	•	•			
	RTG20006BB	Outlet Thermistor - Black			•	•	•
	RTG20223J	Ambient Thermistor - Blue	•	•			
	RTG20006UW	Ambient Thermistor - Blue			•	•	•
	RTG20223W	Thermistor Wiring Harness	•	•			
	RTG20239M	Thermistor Wiring Harness			•	•	•
2	RTG20212V	Gas Control Valve	•	•	•	•	•
	RTG20223V	Gas Control Wiring Harness	•	•			
	RTG20239L	Gas Control Wiring Harness			•	•	•
3	RTG20212W	Burner Assembly	•	•	•	•	•
	RTG20235C	Igniter Coil	•	•	•	•	•
	RTG20212BD	Igniter Rod (IG) (with gasket)	•	•	•	•	•
4	RTG20212AB	Blower Motor	•	•	•	•	•
	RTG20212AC	Blower Case	•	•	•	•	•
5	RTG20212F	Burner Manifold LP	•	•			
5	RTG20235B	Burner Manifold - LP			•	•	•
5	RTG20212X	Burner Manifold NAT	•	•			
5	RTG20239A	Burner Manifold NAT			•	•	•
	RTG20212BE	Flame Rod FL-1 (with gasket)	•	•	•	•	•
	RTG20212P	Flame Rod Wire (White)	•	•	•	•	•
6	RTG20164K	Gas Inlet Connector ¾"	•	•	•	•	•
7	RTG20223E	Water Control Valve	•	•			
	RTG20164L	Water Control Valve			•	•	•
	RTG20164M	Bypass Assembly	•	•	•	•	•
8	RTG20164J	Water Inlet Connector ¾"	•	•	•	•	•
9	RTG20164AK	Inlet Water Filter	•	•	•	•	•
10	RTG20074CE	Hot Water Outlet Connector ¾"	•	•	•	•	•
	RTG20006AV	Drain Plug with Relief	•	•	•	•	•
11	RTG20164AA	Remote Control Terminal Block	•	•	•	•	•
	RTG20212U	Remote Control Terminal	•	•	•	•	•
12	RTG20223F	Neutralization Replacement Kit	•	•			
	RTG20239N	Neutralization Replacement Kit			•	•	•
13	RTG20223A	Front Cover - No Labels or Branding	•	•	•	•	•
	RTG20074EH	Gas Shutoff Valve ¾"	•	•	•	•	•
	RTG20186	Replacement Screw Kit	•	•	•	•	•
	RTG20206	Replacement O-Ring Kit	•	•	•	•	•

See Pages 6 - 9 for additional Accessories, Manifold Systems, and Venting Options.

Parts for RUTG-64, RUTG-84, RUTG-95, DV and DVL Series

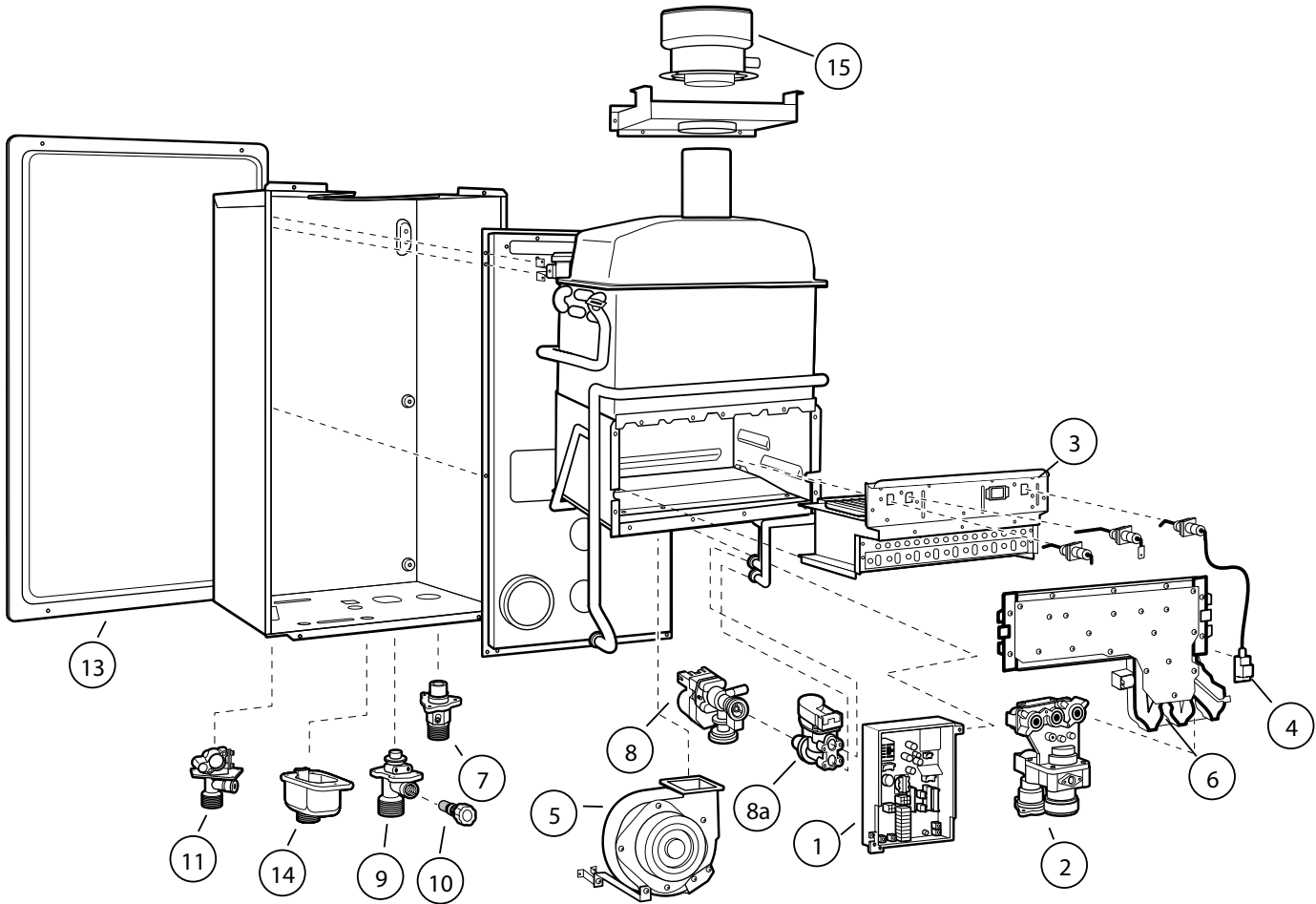

Program Chips

Fuel Type	RUTG-64DV	RUTG-84DV	RUTG-95DV	RUTG-64DVL	RUTG-84DVL	RUTG-95DVL
Natural	RTG20212AV	RTG20212AL	RTG20212S	RTG20235N	RTG20235J	RTG20235E
Propane	RTG20212AW	RTG20212AM	RTG20212T	RTG20235P	RTG20235K	RTG20235F

185°F Temp. Upgrade Kits - Commercial and Hydronic

Fuel Type	RUTG-64DV	RUTG-84DV	RUTG-95DV	RUTG-64DVL	RUTG-84DVL	RUTG-95DVL
Natural	—	RTG20216A	RTG20214A	—	RTG20237A	RTG20236A
Propane	—	RTG20216B	RTG20214B	—	RTG20237B	RTG20236B

Accessories

Remote Controls

RTG20006DW UMC-117 Main Remote Control
 RTG20006DU USC1-117 Bath Remote Control
 RTG20006DV USC2-117 Second Bath Remote Control

Pipe Covers

RTG20217DVG Pipe Cover (grey)

Service Valves

RTG20220 Tankless Service Valve Kit with Relief Valve
 RTG20220AB Tankless Service Valve Kit with Relief Valve - California Code

Relief Valve

AP12993C Pressure Relief Valve

EZ-Link™ Cable

RTG20040 6-ft. EZ-Link™ Cable

Parts for RUTG-64, RUTG-84, RUTG-95, DV and DVL Series

Ref #	Ruud Part #	Description	RUTG-64DV	RUTG-84DV	RUTG-95DV	RUTG-64DVL	RUTG-84DVL	RUTG-95DVL
1	RTG20212R	Control Board	•	•	•			
	RTG20235D	Control Board				•	•	•
	RTG20164R	Ambient Thermistor - Blue	•	•	•			
	RTG20006UW	Ambient Thermistor - Blue				•	•	•
	RTG20212BC	Heat Exchanger Thermistor - Yellow	•	•	•	•	•	•
	RTG20006AR	Inlet Thermistor - White	•	•	•	•	•	•
	RTG20006BB	Outlet Thermistor - Black	•	•	•	•	•	•
	RTG20239M	Thermistor Wiring Harness	•	•	•	•	•	•
2	RTG20212C	Gas Valve Assy	•	•	•	•	•	•
3	RTG20212D	Burner Assembly	•	•	•	•	•	•
6	RTG20212E	Burner Manifold - NAT	•	•	•			
	RTG20235A	Burner Manifold - NAT				•	•	•
6	RTG20212F	Burner Manifold - LP	•	•	•			
	RTG20235B	Burner Manifold - LP				•	•	•
	RTG20212BE	Flame Rod "FL1" (Right) w/gasket	•	•	•	•	•	•
	RTG20212J	Gas Control Resistor	•	•	•	•	•	•
	RTG20212BF	Flame Rod "Sensor" (Left) w/gasket	•	•	•	•	•	•
	RTG20212N	Flame Rod Wire (Blue)	•	•	•	•	•	•
	RTG20212P	Flame Rod Wire (White)	•	•	•	•	•	•
4	RTG20235C	Igniter Coil	•	•	•	•	•	•
	RTG20212BD	Igniter Rod (Right) w/gasket	•	•	•	•	•	•
5	RTG20212K	Blower Motor	•	•	•	•	•	•
	RTG20212L	Blower Case	•	•	•	•	•	•
7	RTG20164K	Gas Inlet Connector 3/4"	•	•	•	•	•	•
8	RTG20164L	Water Control Valve	•	•	•	•	•	•
8a	RTG20164M	Water Bypass Valve	•	•	•	•	•	•
9	RTG20164J	Water Inlet Connector 3/4"	•	•	•	•	•	•
11	RTG20074CE	Hot Water Outlet Connector 3/4"	•	•	•	•	•	•
14	RTG20212U	Remote Control Terminal	•	•	•	•	•	•
	RTG20164AA	Remote Control Terminal Block	•	•	•	•	•	•
	RTG20006AV	Drain Plug with Relief	•	•	•	•	•	•
	RTG20212A	Top Mounting Bracket	•	•	•	•	•	•
	RTG20212B	Bottom Mounting Bracket	•	•	•	•	•	•
	RTG20164AB	Screw Pan FT 4X12	•	•	•	•	•	•
10	RTG20164AK	Inlet Water Filter	•	•	•	•	•	•
13	RTG20212BA	Front Cover - No Labels or Branding	•	•	•	•	•	•
15	RTG20212BB	Concentric Vent Connector Assembly	•	•	•	•	•	•
	RTG20074EH	Gas Shutoff Valve 3/4"	•	•	•	•	•	•
	RTG20186	Replacement Screw Kit	•	•	•	•	•	•
	RTG20206	Replacement O-Ring Kit	•	•	•	•	•	•

See Pages 6 - 9 for additional Accessories, Manifold Systems, and Venting Options.

Parts for RUTG-64, RUTG-84, RUTG-95, X and XL Series

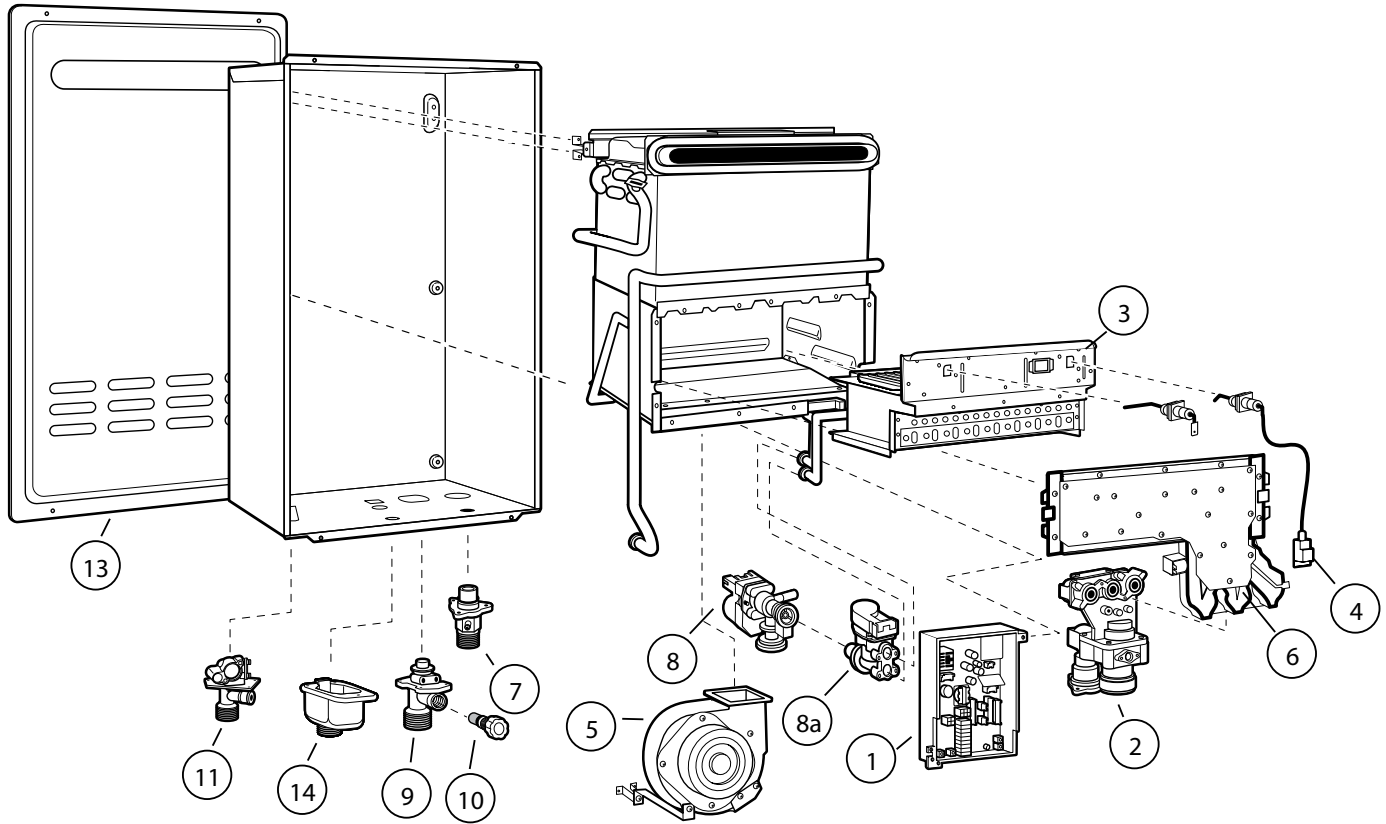

Program Chips

Fuel Type	RUTG-64X	RUTG-84X	RUTG-95X	RUTG-64XL	RUTG-84XL	RUTG-95XL
Natural	RTG20212AE	RTG20212AN	RTG20212AX	RTG20235R	RTG20235L	RTG20235G
Propane	RTG20212AH	RTG20212AP	RTG20212AY	RTG20235S	RTG20235M	RTG20235H

185°F Temp. Upgrade Kits - Commercial and Hydronic

Fuel Type	RUTG-64X	RUTG-84X	RUTG-95X	RUTG-64XL	RUTG-84XL	RUTG-95XL
Natural	—	RTG20216C	RTG20214C	—	RTG20237C	RTG20236C
Propane	—	RTG20216D	RTG20214D	—	RTG20237D	RTG20236D

Accessories

Remote Controls	RTG20006DW UMC-117 Main Remote Control RTG20006DU USC1-117 Bath Remote Control RTG20006DV USC2-117 Second Bath Remote Control
Pipe Covers	RTG20217XG Pipe Cover (grey)
Recess Box	RTG20218 Recess Box (grey)
Service Valves	RTG20220 Tankless Service Valve Kit with Relief Valve RTG20220AB Tankless Service Valve Kit with Relief Valve - California Code
Relief Valve	AP12993C Pressure Relief Valve
EZ-Link™ Cable	RTG20040 6-ft. EZ-Link™ Cable

Parts for RUTG-64, RUTG-84, RUTG-95, X and XL Series

Ref #	Ruud Part #	Description	RUTG-64X	RUTG-84X	RUTG-95X	RUTG-64XL	RUTG-84XL	RUTG-95XL
1	RTG20212AD	Control Board	•	•	•			
	RTG20235D	Control Board				•	•	•
	RTG20212BC	Heat Exchanger Thermistor - Yellow	•	•	•	•	•	•
	RTG20006BB	Outlet Thermistor - Black	•	•	•	•	•	•
	RTG20006AR	Inlet Thermistor - White	•	•	•	•	•	•
	RTG20006UW	Ambient Thermistor - Blue	•	•	•	•	•	•
	RTG20239M	Thermistor Wiring Harness	•	•	•	•	•	•
2	RTG20212V	Gas Valve Assy	•	•	•	•	•	•
	RTG20212J	Gas Control Resister	•	•	•	•	•	•
3	RTG20212W	Burner Assembly	•	•	•	•	•	•
	RTG20212G	Flame Rod "FL" (Right)	•	•	•	•	•	•
	RTG20212BE	Flame Rod "FL" (Right) w/gasket	•	•	•	•	•	•
	RTG20212M	Igniter Rod (Right)	•	•	•	•	•	•
	RTG20212BD	Igniter Rod (Right) w/gasket	•	•	•	•	•	•
	RTG20212P	Flame Rod Connector (White)	•	•	•	•	•	•
4	RTG20235C	Igniter Coil	•	•	•	•	•	•
5	RTG20212AB	Blower Motor	•	•	•	•	•	•
	RTG20212AC	Blower Case	•	•	•	•	•	•
6	RTG20212X	Burner Manifold - NAT	•	•	•			
	RTG20235A	Burner Manifold - NAT				•	•	•
	RTG20212F	Burner Manifold - LP	•	•	•			
	RTG20235B	Burner Manifold - LP				•	•	•
7	RTG20164K	Gas Inlet Connector 3/4"	•	•	•	•	•	•
8	RTG20164L	Water Control Valve	•	•	•	•	•	•
8a	RTG20164M	Water Bypass Valve	•	•	•	•	•	•
9	RTG20164J	Water Inlet Connector 3/4"	•	•	•	•	•	•
	RTG20006AV	Drain Plug with Relief	•	•	•	•	•	•
11	RTG20074CE	Hot Water Outlet Connector 3/4"	•	•	•	•	•	•
	RTG20212U	Remote Control Terminal	•	•	•			
	RTG20164AA	Remote Control Terminal Block	•	•	•	•	•	•
	RTG20164AB	Screw Pan FT 4X12	•	•	•	•	•	•
10	RTG20164AK	Inlet Water Filter	•	•	•	•	•	•
13	RTG20212AZ	Front Cover - No Labels or Branding	•	•	•	•	•	•
	RTG20074EH	Gas Shutoff Valve 3/4"	•	•	•	•	•	•
	RTG20186	Replacement Screw Kit	•	•	•	•	•	•
	RTG20206	Replacement O-Ring Kit	•	•	•	•	•	•

See Pages 6 - 9 for additional Accessories, Manifold Systems, and Venting Options.



Why Ruud?

Over the last 100 years, we've made a habit of delivering reliable water heating products. No matter how advanced our engineering has become, we'll always "make them like we used to." With Ruud, you get a history of doing things right and our word that you can **Rely on Ruud.**[™]

In keeping with its policy of continuous progress and product improvement, Ruud reserves the right to make changes without notice.

Ruud Replacement Parts • 4744 Island Ford Road
Randleman, NC 27317 • 336.495.6800 • 336.495.6897 fax
www.Ruudparts.com

Technical Support 800.432.8373
Customer Service 800.621.5622

Ruud Water Heating • 101 Bell Road
Montgomery, Alabama 36117-4305 • www.Ruud.com

Printed in U.S.A. 09/16 WP TKRPP-101 Rev. 6

RELY ON RUUD.[™]