

MANUFACTURING
NUMBERS:

9700610
9700612
9700614
9700616

vizion™

by A.J. Antunes & Co.

WATER FILTRATION SYSTEM

UFC-420/440 Series



P/N 1010908 Rev. A 03/12



Owner's Manual

TABLE OF CONTENTS

Owner Information	2	LED Display	10
General	2	Starting the System	10
Warranty Information	2	Programming Timer	11
Service/Technical Assistance	3	Setting the Flush Interval (FI).....	11
Important Safety Information	3	Setting Flush Duration (FD).....	11
Specifications	5	Programming Timer While Unit is in Flush Interval (FI)	
Electrical Ratings.....	5	Mode.....	12
Electrical Cord & Plug Configurations	5	Manual Flushing	13
Specifications (Filter Cartridges)	5	Maintenance	14
Dimensions	5	Checking the Timer Program.....	14
Specifications	6	Changing the Cartridges	14
Components	6	Troubleshooting	15
Installation	7	Replacement parts UFC-420/440	16
Unpacking.....	7	Recommended Equipment Schematic	17
Equipment Setup	7	Wiring Diagram	18
Locating and Mounting the system	8	Notes	19
Operation	10	LIMITED WARRANTY	Back Cover
Filtration Process.....	10		

OWNER INFORMATION

General

A.J. Antunes & Co., has partnered with companies from around the globe to produce the UFC-Series water filtration systems. The UFC-Series removes bacteria and provides a substantial reduction of viruses that can enter a typical water supply. This patented technology is now available to you, sized for your particular application. All filter configurations utilize NeoH capillary membranes, providing the latest innovation in reusable surface filtration technology.

This manual provides the safety, installation and operating procedures for the UFC-Series water filtration systems. We recommend that all information contained in this manual be read prior to installing and operating the unit.

Your UFC-Series unit is manufactured from the finest materials available and is assembled to our strict quality standards. This unit has been tested at the factory to ensure dependable trouble-free operation.

Warranty Information

Please read the full text of the Limited Warranty in this manual.

If the unit arrives damaged, contact the carrier immediately and file a damage claim with them. Save all packing materials when filing a claim. Freight damage claims are the responsibility of the purchaser and are not covered under warranty.

The warranty **does not** extend to:

- Damages caused in shipment or damage as result of improper use.
- Installation of electrical service.
- Normal maintenance as outlined in this manual.
- Malfunction resulting from improper maintenance.
- Damage from moisture leaking into electrical components.
- Normal maintenance as outlined in this manual.
- Damage from tampering with, removal of, or changing any preset control or safety device.

IMPORTANT! Keep these instructions for future reference. If the unit changes ownership, be sure this manual accompanies the equipment.

OWNER INFORMATION (continued)

Service/Technical Assistance

If you experience any problems with the installation or operation of your unit, contact Antunes Filtration Technologies at **1-630-784-1000**, or toll free in the United States at **1-800-253-2991**.

Fill in the information in the next column and have it handy when calling for assistance. The serial number is on the specification plate located on the unit.

Purchased From: _____

Date of Purchase: _____

Model No.: _____

Serial No.: _____

Mfg. No.: _____

IMPORTANT

Antunes Filtration Technologies reserves the right to change specifications and product design without notice. Such revisions do not entitle the buyer to corresponding changes, improvements, additions or replacements for previously purchased equipment.

IMPORTANT SAFETY INFORMATION

Throughout this manual, you will find the following safety words and symbols that signify important safety issues with regards to operating or maintaining the unit.

In addition to the warnings and cautions in this manual, use the following guidelines for safe operation of the unit.

WARNING

GENERAL WARNING. Indicates information important to the proper operation of the equipment. Failure to observe may result in damage to the equipment and/or severe bodily injury or death.

WARNING

ELECTRICAL WARNING. Indicates information relating to possible shock hazard. Failure to observe may result in damage to the equipment and/or severe bodily injury or death.

CAUTION

GENERAL CAUTION. Indicates information important to the proper operation of the equipment. Failure to observe may result in damage to the equipment.

- Read all instructions before using equipment.
- For your safety, the equipment is furnished with a properly grounded cord connector. Do not attempt to defeat the grounded connector.
- Install or locate the equipment only for its intended use as described in this manual. Do not use corrosive chemicals in this equipment.
- Do not operate this equipment if it has a damaged cord or plug; if it is not working properly, or if it has been damaged or dropped.
- This equipment should be serviced by qualified personnel only. Contact Antunes Filtration Technologies for repair.
- Do not immerse cord or plug in water.
- Keep cord away from heated surfaces.

IMPORTANT SAFETY INFORMATION (continued)

The following warnings and cautions appear throughout this manual and should be carefully observed.

- Turn the unit off and disconnect the power source before performing any service or maintenance on the unit.
- The equipment should be grounded according to local electrical codes to prevent the possibility of electrical shock. It requires a grounded receptacle with separate electrical lines, protected by fuses or circuit breaker of the proper rating.
- All electrical connections must be in accordance with local electrical codes and any other applicable codes.
- **WARNING ELECTRICAL SHOCK HAZARD. FAILURE TO FOLLOW THESE INSTRUCTIONS COULD RESULT IN SERIOUS INJURY OR DEATH.**
 - Electrical ground is required on this appliance.
- Do not modify the power supply cord plug. If it does not fit the outlet, have a proper outlet installed by a qualified electrician.
- Do not use an extension cord with this appliance.
- Check with a qualified electrician if you are in doubt as to whether the appliance is properly grounded.
- If the supply cord is damaged, it must be replaced by the manufacturer or its service agent or a similarly qualified person.
- This equipment is to be installed to comply with the local plumbing code and any other applicable code.
- Water pressure must not exceed the membrane differential pressure of 45 psig (3.1 bar). To reduce water pressure, install a water pressure regulator and set the system inlet water pressure to 45 psi (3.1) bar.

WATER CONDITION EQUIPMENT GUIDELINES



Inlet Water Pressure (psi)	Inlet Turbidity (NTU)	Required Additional Equipment Installed	Water Use (Gallons Per Day)	Flush Program
Less than 45 psi	Less than 1 NTU	<i>Required:</i> No additional equipment <i>Recommended:</i> Inlet water strainer (150 micron/ 100 mesh screen) <i>Recommended:</i> Permeate Tank	Less than 300 GPD	Flush Program: Interval: 6 hour Duration: 15 seconds
			Greater than 300 GPD	Flush Program: Interval: 1 hour Duration: 15 seconds
Greater than 45 psi	Less than 1 NTU	<i>Required:</i> Pressure regulator <i>Recommended:</i> Inlet water strainer (150 micron/ 100 mesh screen) <i>Recommended:</i> Permeate Tank	Less than 300 GPD	Flush Program: Interval: 6 hour Duration: 15 seconds
			Greater than 300 GPD	Flush Program: Interval: 1 hour Duration: 15 seconds
Less than 45 psi	Greater than 1 NTU	<i>Required:</i> Inlet water strainer (150 micron/ 100 mesh screen) <i>Required:</i> Permeate Tank	Any	Flush Program: Interval: 1 hour Duration: 15 seconds
Greater than 45 psi	Greater than 1 NTU	<i>Required:</i> Pressure regulator <i>Required:</i> Inlet water strainer (150 micron/ 100 mesh screen) <i>Required:</i> Permeate Tank	Any	Flush Program: Interval: 1 hour Duration: 15 seconds

SPECIFICATIONS

Electrical Ratings

Voltage	Watts	Hertz
120	10	50/60
230	10	50/60

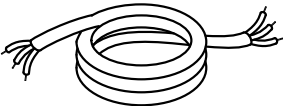
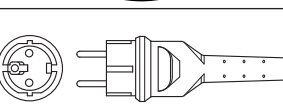
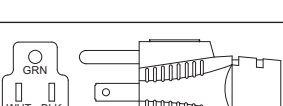
Electrical Cord & Plug Configurations

Letter Code*	Description	Configuration
C	Commercial Cord	
H	Harmonized Cord	
(H)C	CEE 7/7, 16 Amp., 250 VAC (Assembly Only).	
(C)F	5-15P, 15 Amp., 120 VAC., Non-Locking (Assembly Only).	

Specifications (Filter Cartridges)

Maximum Operating Pressure	3 bar (45 psi)
Maximum Operating Temp.	40°C (104°F)
Trans Membrane Pressure	0.5-2.5 Bar (7-36 psi)
pH Range	3-10
MWCO	100 kD
Sanitizing Temp.	80°C (176°F)

Dimensions

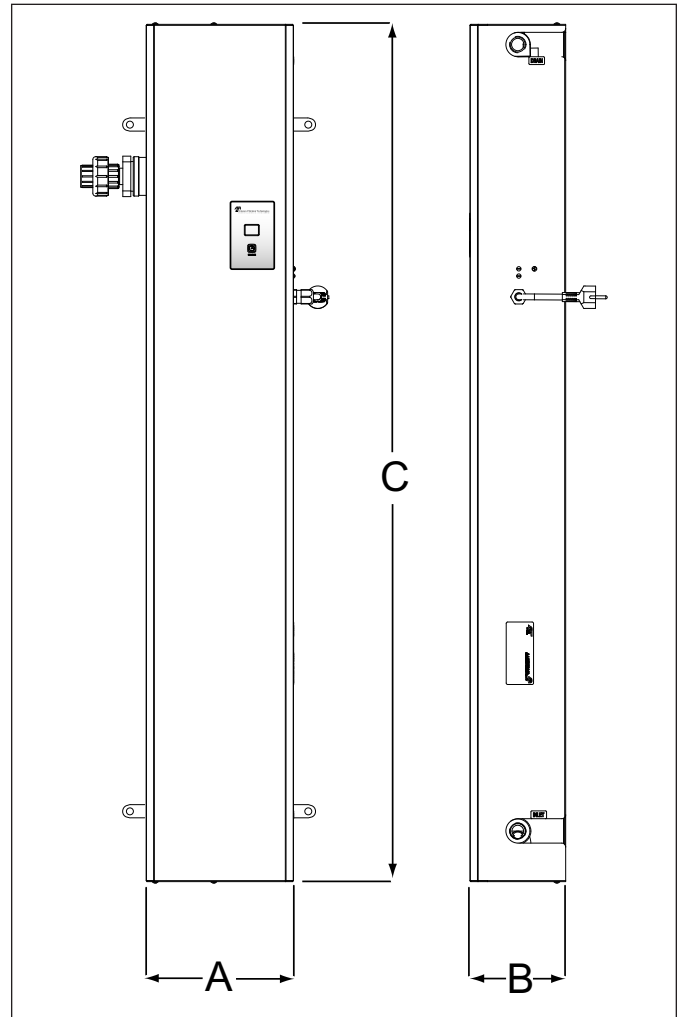

Figure 1. Dimensions

Unit	A Width	B Depth	C Height	Operating Weight (w/ water)
UFC-420	10 inches (254 mm)	6.125 inches (155.57 mm)	35.25 inches (895.35 mm)	42 lbs. (19.05 kilos)
UFC-440	10 inches (254 mm)	6.125 inches (155.57 mm)	55.25 inches (1403.35 mm)	72 lbs. (32.66 kilos)

⚠ WARNING ⚠

ELECTRICAL SHOCK HAZARD.

FAILURE TO FOLLOW THE INSTRUCTIONS IN THIS MANUAL COULD RESULT IN SERIOUS INJURY OR DEATH.

- Electrical ground is required on this appliance.
- Do not modify the power supply cord plug. If it does not fit the outlet, have a proper outlet installed by a qualified electrician.
- Do not use an extension cord with this appliance.
- Check with a qualified electrician if you are in doubt as to whether the appliance is properly grounded.

⚠ CAUTION ⚠

All electrical connections must be in accordance with local electrical codes and any other applicable codes.

SPECIFICATIONS

Components

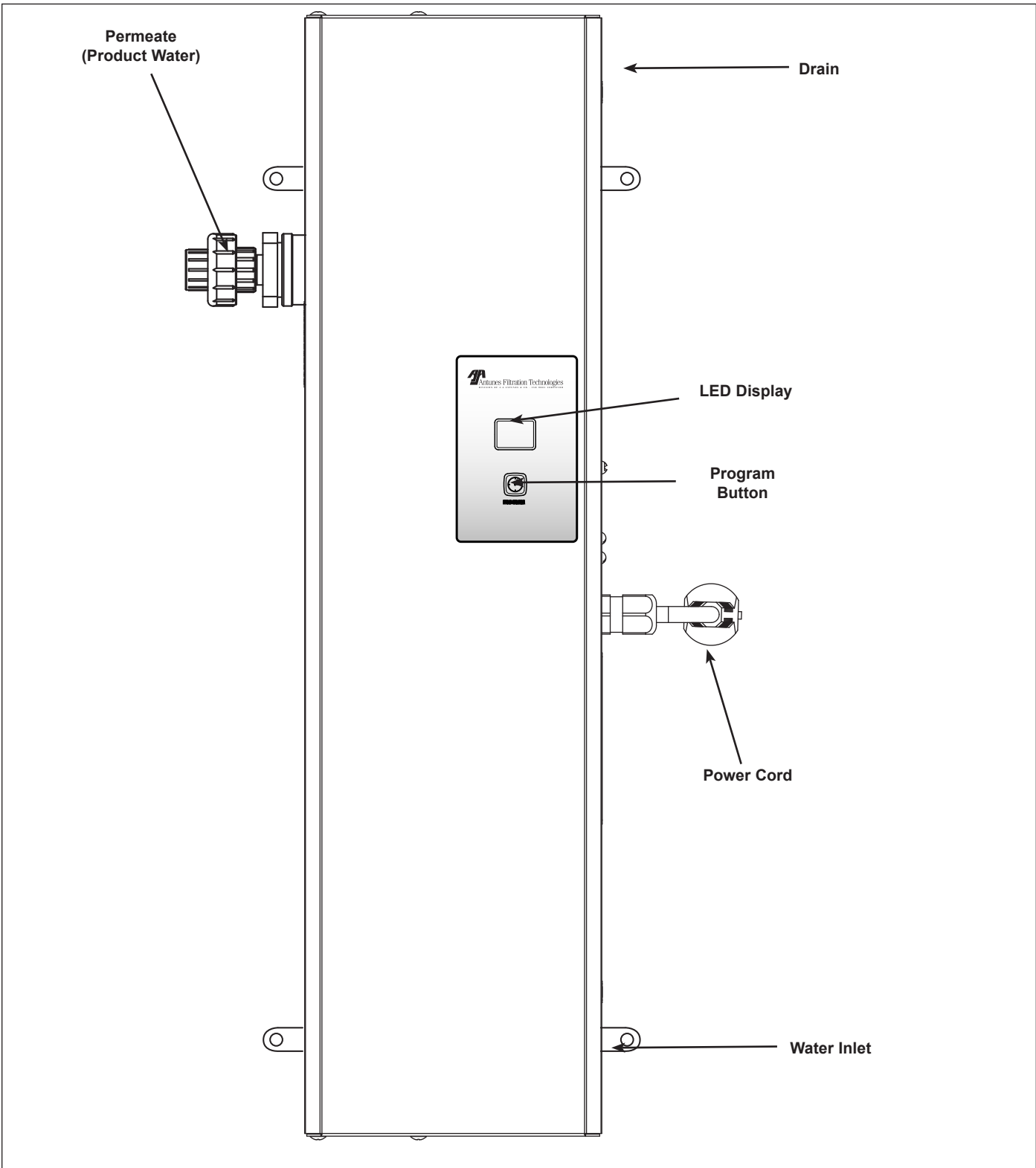

Figure 2. Components

INSTALLATION

Unpacking

1. Remove the system and all packing materials from the chipping carton.
2. Remove all packing materials and protective coverings from the system
3. Remove the information packet. To prevent any delay in obtaining warranty coverage, fill out and mail the warranty card.

NOTE: If any parts are damaged, contact Antunes Filtration Technologies IMMEDIATELY at 1-800-253-2991 or 1-630-784-1000.

Equipment Setup

GENERAL

When placing the unit into service, pay attention to the following guidelines:

- Make sure power to the unit is off.
- Do not immerse cord or plug in water.
- Keep cord away from heated surfaces.

ELECTRICAL

Ensure that the line voltage corresponds to the stated voltage on the units specification label. Make sure that the plug on the power cord from the system and the outlet match. For proper operation, and to ensure the highest quality water from the system, make sure that the system is not connected to a switched electrical outlet.

PLUMBING

NOTE: This unit is designed to use tap water not to exceed 104°F (40°C).

The UFC-420 and UFC-440 systems use the following connections (Figure 1):

- | | |
|----------------------------|----------|
| • Water Inlet | 3/4" NPT |
| • Permeate (Product Water) | 3/4" NPT |
| • Drain | 3/4" NPT |

When making a plumbing connection to the system, remember to use a back-up wrench on the supporting plumbing. Always use a good quality, approved, pipe sealant or thread seal tape on pipe threads. Be careful not to get the pipe sealant inside the pipe when making the connections.

Do not over tighten the connections. It is recommended that plastic fittings be used when connecting to the plastic connections of the system. This will reduce the possibility of cracking the connections due to overtightening.

If soldered plumbing is used, do not apply heat to, or near, the filtration system. The use of union (O-ring seal) connections is highly recommended for ease of installation and future servicing.

SUGGESTED TOOLS AND SUPPLIES FOR INSTALLATION

The following tools and supplies are suggested to make the installation easier:

- | | |
|---------------------------------------|---------------------------------|
| • Screwdriver | • Adjustable wrenches |
| • Drill with bits | • Pipe wrenches |
| • Strap wrench | • Level |
| (up to 6" diameter) | • Pipe dope or thread seal tape |
| • Tape measure | |
| • Two gallon bucket | |
| • Fresh 5 1/4% liquid chlorine bleach | |

INSTALLATION (continued)

Locating and Mounting the system

Consider these points before mounting the system:

- Note the location of the water supply, drain, and an appropriate electrical outlet when choosing a mounting location.
- Remember to allow for access to the timer/ programmer controls.
- Do not mount the system above any electrical equipment, or items that may be damaged if they get wet.
- Install the system in a location that will allow for future service access.
- Mount the system on a wall using appropriate mounting hardware.
- Remember to consider the operating weight of the system when choosing mounting hardware. Depending on the type of wall the system is being mounted to, wall reinforcement may be necessary.

INLET WATER PLUMBING

It is recommended that the inlet water plumbing line be 3/4" NPT or larger. A shutoff valve (not supplied) should be installed in the line leading to the system. The valve should be mounted close to the system inlet, and sized properly for the inlet plumbing line. This valve will allow for easier servicing and future cartridge change-out. The system should only be connected to the cold water line.

To ensure that the highest quality water is produced from the system, the plumbing leading to the filter system must be flushed clear of all debris before the system is hooked up. Before making the connection to the inlet of the filter system, hold a bucket or other container at the inlet water line and slowly open the inlet water valved. Allow the pipe to flush until all debris is removed.

PERMEATE LINE PLUMBING

To ensure the highest quality and safest water, it is recommended that a check valve (to prevent backflow) be installed in the water line after the permeate connection. This will help prevent possible contamination of the filter system due to other equipment downstream. The check valve (not supplied) should be mounted close to the system outlet, and sized properly for the plumbing line. Check with local codes for the proper specification.

DRAIN LINE PLUMBING

The drain line is used to flush away the particle buildup when cleaning the filter. The drain line must be able to support the flow rate when the system flushes. The flow rate from the flush depends on the inlet water pressure, inlet pipe size, and system selected. It is recommended that the drain line be as large as, or larger than, the inlet plumbing line. The drain line should be as short as possible, sloping downward without kinks or loops. Be sure that the drain used is not blocked or restricted.

The filter system must be protected from possible back contamination by the installation of an air gap between the drain connection of the system and the drain (Figure 3). This gap in the line, with no physical contact between the system and sewer, prevents contamination of the system in the event of a backed-up sewer.

NOTE: Make sure that the end of the drain line is positioned and secured at least 2 inches above the drain so that the water flow is directed into the drain, without splashing.

FLUSHING AND STARTING THE SYSTEM

To ensure that the highest quality water is produced from the system, the plumbing leading from the filter system must be flushed clear of all debris after the system is hooked up. After making the connection to the outlet of the filter system, open a faucet or tap closest to the filter system, then slowly open the inlet water valve. Allow the pipe to flush until all debris is removed.

⚠ CAUTION ⚠

This equipment is to be installed to comply with the basic plumbing code of the Building Officials and Code Administrators, Inc. (BOCA) and the Food Service Sanitation Manual of the Food and Drug Administration (FDA).

⚠ CAUTION ⚠

Water pressure must not exceed a membrane differential pressure of 3 bar (45 psi). To reduce water pressure, install a water pressure regulator and set water pressure to 45 psi.

INSTALLATION (continued)

The unit also must be flushed to remove air and the shipping/storage solution. For maximum quality, the permeate water produced during the flushing procedure must be discarded. Direct this permeate water to drain.

⚠ CAUTION ⚠

Ingesting the protective solution may cause irritation of the gastrointestinal tract, colic, diarrhea, or other similar symptoms

1. Plug the power cord into the appropriate electrical outlet. The display will power on and the LED display will display the following for about two seconds each:
 - 8.8
 - F8 followed by its time settings in seconds
 - F1 and its time setting in minutes or hours.

The F8 and F1 sequence repeats for 30 seconds after which the unit automatically returns to the Flush Interval Mode (F1). The time setting for F1 will be displayed and the decimal point will flash in one second intervals.

2. Open the tap or faucet closest downstream to the filter system.
3. Slowly open the inlet water valve and allow water to enter the system.
4. Press and hold the Start button. After 6-7 seconds, the drain valve will open and FL will appear on the display.
5. Continue holding the Start button down for at least 30 seconds to keep the drain open. This flushes air out of the center of the hollow fibers. The drain will remain open as long as the Start button is pressed. Check to make sure that the drain water is directed into the drain without splashing.
6. Release the Start button. This closes the drain valve. Water should continue to flow through the system and out of the open tap. Allow water to flow out of the tap for at least 15 minutes at maximum flow rate.
7. Close the tap and let the system stand with no water flow for 15 minutes to allow any trapped air to come out of the hollow fibers. Check for leaks at all fittings.

8. After 15 minutes without water flow, open the tap for 5 minutes to allow any trapped air to be flushed out.
9. Close the tap. Flushing is complete.

SANITIZING THE SYSTEM AND LINES

The plumbing must be sanitized to eliminate possible contamination that may have occurred during the installation process. Chlorine bleach can be used to sanitize the plumbing. The amount of bleach to use depends on the system installed and the amount of plumbing downstream of the filter system. Generally, 1 or 2 ounces (30 ml) of bleach will be sufficient to sanitize the system.

1. Make sure that the system has been flushed of air and debris as described in the Flushing and Starting up the System section of this manual.
2. Open the tap closest downstream to the filter system.
3. Close the inlet water valve and allow the system to depressurize.
4. Place a bucket under the strainer at the inlet connection to the system. Open the strainer by unscrewing the cap. Water will flow out of the strainer as the system drains.
5. When the water flow out of the strainer stops, pour the liquid bleach into the strainer. Be careful not to spill bleach onto clothing or skin. You may want to add the bleach using a cup. Reattach the cap on the strainer.
6. Slowly open the inlet water valve and allow water to flow out of the tap until the smell of bleach is present.
7. Close the tap and let the system stand with no water flow for at least 15 minutes to allow the bleach to sanitize the pipes.
8. After 15 minutes without flow, open the tap and flush until the presence of bleach is gone. All other taps should be opened to flush any bleach from the plumbing.
9. Close the tap. The sanitization is complete.

Program the timer following the procedure outlined in the Operation section of this manual.

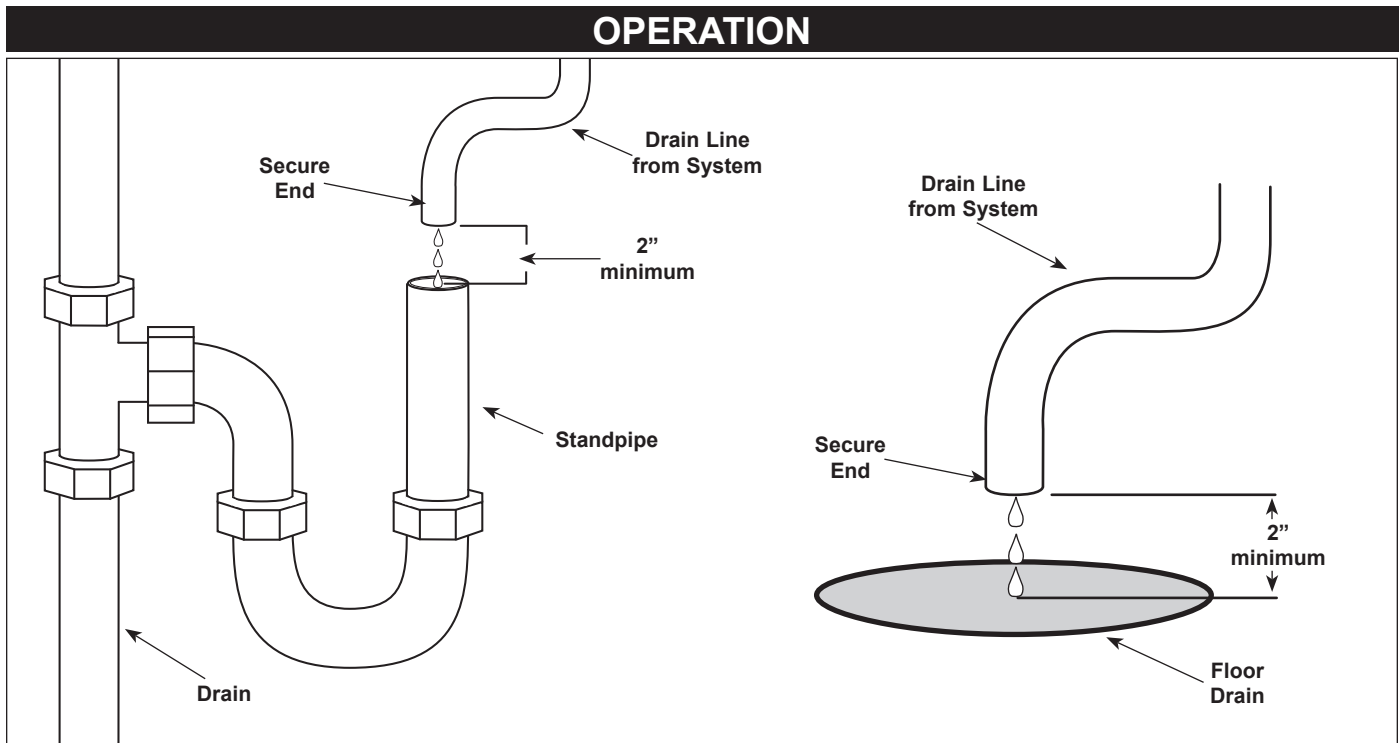

Figure 3. Proper Draining

Filtration Process

Water filtration in the UFC Series is accomplished using two modes: Flush Interval Mode, shown as F_i on the LED Display and Flush Duration Mode (F_D on LED display). During the Flush Interval, water enters the inlet and flows through the filter element before exiting the Permeate outlet as usable product water.

After a certain period of time, depending upon water quality, the filter has to be cleaned. This is accomplished through the Flush Duration Mode. During this mode, the drain valve opens and flushes the membrane to remove debris collected inside the membrane walls.

NOTE: Both the Flush Interval Mode and the Flush Duration Mode can be automated by programming the timer. During the Flush Interval Mode, the valve is not powered in order to keep water filtering during a power outage.

LED Display

F_i - Flush Interval Mode is the time between flushings and is displayed in minutes or hours.

F_D - Flush Duration Mode is the amount of time used to flush and remove debris from filter cartridge and is displayed in seconds.

F_L - Manual Flush Mode operation, solenoid is manually activated by the user.

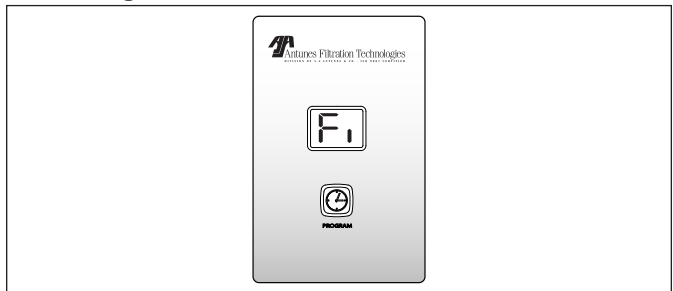

Figure 4. LED Display, Front Panel

Starting the System

Power up the unit.

The LED read-out displays the following for about two seconds each:

1. 8.8
2. F_D followed by its time settings in seconds.
3. F_i and its time setting, in minutes or hours.

The F_D , F_i sequence repeats for 30 seconds after which, the unit automatically returns to the Flush Interval Mode (F_i). The time setting for F_i will be displayed and the decimal point will flash in one second intervals.

NOTE: The timer can be programmed immediately after start-up or while in Flush Interval Mode.

OPERATION (continued)

Programming Timer

NOTE: Once the UFC unit is powered up, the LED display cycles through the default or current settings: Flush Duration (Fd) and its setting will be followed by Flush Interval (Fi) and its settings. At any time during this sequence, which lasts approximately 30 seconds the UFC unit can be programmed.

Setting the Flush Interval (Fi)

1. When Fi (Figure 5) is displayed, press and release start button to view current setting .
2. To make a change, press and hold down start button to scroll through settings - release button at desired setting (Figure 6).
3. After ten seconds, unless start button is depressed, unit automatically returns to Flush Interval Mode.

NOTE: Fi times are displayed in ten minute intervals, after fifty minutes they are displayed in hours (Table A).

Setting Flush Duration (FD)

2. When Fd is displayed, press and release start button to view current setting (Figure 7).
3. To make a change, press and hold down start button to scroll through settings - release button at desired setting (Figure 8).
4. After ten seconds, unless button is depressed, unit automatically returns to Flush Interval Mode.

NOTE: Fd times are displayed in 5 second intervals up to 60 seconds (Table A).

Fi - Flush Interval Mode	Fd - Flush Duration Mode
1- 10 minutes	5 5 seconds
5- 50 Minutes	10 10 seconds
01 1 Hour	15 15 Seconds
12 12 Hours	30 30 Seconds
24 24 hours	60 60 Seconds

Table A. LED Display Settings



Figure 5. LED Display for Flush Interval Mode



Figure 6. Time Setting Fi Mode (22 Hours)



Figure 7. LED Display for Flush Duration Mode

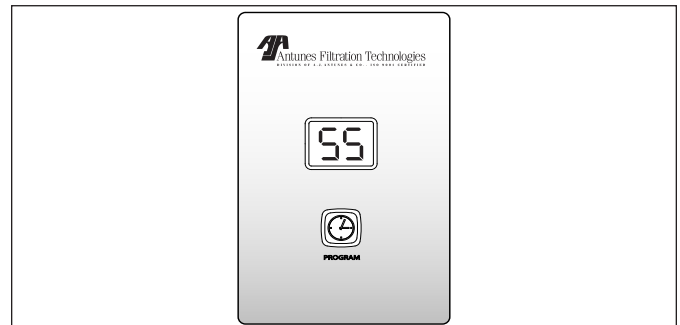

Figure 8. Time Setting Fd Mode (55 Seconds)

OPERATION (continued)

Programming continued

Programming Timer While Unit is in Flush Interval (FI) Mode

TO SET FI - FLUSH INTERVAL MODE

NOTE: After power-up and cycling - Fi time setting displays a flashing decimal point.

1. Press and hold down start button for four seconds. Release button, LED will display. Fd followed by its setting.
2. When Fi (Figure 7) is displayed, press and release button to view current setting.
3. To make a change, press and hold down start button to scroll through settings - release button at desired setting (Figure 8).
4. After ten seconds, if start button is not pressed, unit automatically returns to Flush Interval Mode.

NOTE: Fi times are displayed in ten minute intervals, after fifty minutes they are displayed in hours (Table B).

TO SET FD - FLUSH DURATION MODE

1. Press and hold down start button for four seconds. Release button, LED will display. Fd.
2. When Fd is displayed (Figure 9), press and release button to view current setting .
3. To make a change, press and hold down start button to scroll through settings - release button at desired setting (Figure 10).
4. After ten seconds, if start button is not pressed unit automatically returns to Flush Interval Mode.

NOTE: Fd times are displayed in 5 second intervals up to 60 seconds (Table B).

Fi - Flush Interval Mode	Fd - Flush Duration Mode
1- 10 minutes	5 5 seconds
5- 50 Minutes	10 10 seconds
01 1 Hour	15 15 Seconds
12 12 Hours	30 30 Seconds
24 24 hours	60 60 Seconds

Table B. LED Display Settings



Figure 9. Fi - LED Display for Flush Interval Mode

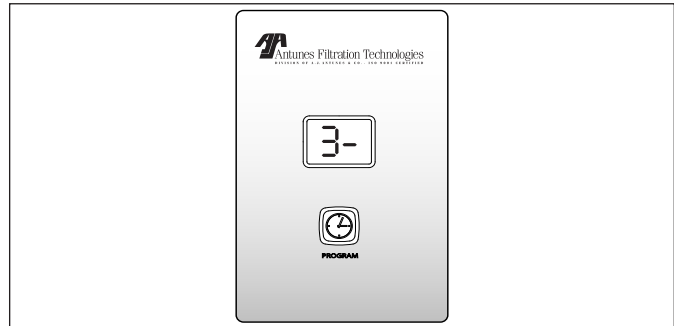

Figure 10. Time display for Fi Mode (30 Minutes)



Figure 11. LED Display for Flush Duration



Figure 12. Time Display for Fd Mode (15 Seconds)

OPERATION (continued)

Manual Flushing

NOTE: Manual flushing only works when unit is in Flush Interval Mode (Fi).

While the unit is in Flush Interval Mode (decimal point flashing), hold the start button down for 6-7 seconds until the LED displays FL (Figure 11). Continue holding the button down to keep the drain open. Drain will remain open for as long as start button is depressed. (FL will flash on LED.) Releasing the button closes the drain and puts the unit back into startup mode. After ten seconds, if the start button is not pressed the unit automatically returns to the Flush Interval Mode (Fi).

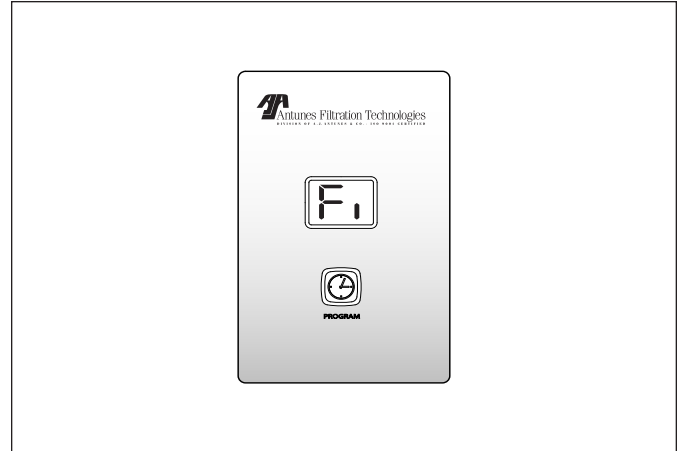

Figure 13. Manual Flush

MAINTENANCE

The filtration system is designed to require very little maintenance. To ensure that the water is of the highest quality, occasionally some service is required.

Checking the Timer Program

During normal operation, the system displays the time setting for the Flush Interval Mode (F_I) and the decimal will flash in one second intervals. This is the time between flushing, not a time of day setting.

Over time, it is possible that the time that the system flushes occurs at a time of high water use. If that creates a problem, the timer can be reset by unplugging the power cord, waiting for 5 seconds, and plugging the power cord in again. The timer then begins timing from the point power is restored to the system. Follow the procedures within the Operation section of this manual to check and set the timer settings.

Changing the Cartridges

While the filtration system is designed for long life, eventually the cartridges will need to be replaced.

1. Open the faucet or tap closest downstream to the filtration system.
2. Close the inlet water valve and allow the system to depressurize.
3. Place a bucket under the strainer at the inlet connection to the system. Open the strainer by unscrewing the cap. Water will flow out of the strainer as the system drains.
4. Press and hold the Start button to help drain the system.
5. Reattach the cap on the strainer when the water flow stops. Unplug the power cord.

6. Using a strap wrench (up to 6" capacity), loosen the top and bottom end caps. **DO NOT** remove the top and bottom End Caps yet.
7. Disconnect the permeate port connection.
8. Unscrew the cartridge end caps from the cartridge, being careful to retain the O-rings from each cap. Set the O-rings aside.
9. Install a new cartridge to the system.
10. Connect the permeate port connection.
11. Inspect the O-rings to make sure they are clean and are not splitting or cut. For all O-rings, make sure they are lubricated with an approved food grade lubricant acceptable for drinking water use.
12. For each end cap, position the O-ring between the end of the cartridge and cap and screw the cap onto the cartridge. Tighten with strap wrench as necessary.
13. Follow the Flushing and Starting the System and Sanitizing the System and Lines procedures in the Installation section of this manual to complete the cartridge change.

SYSTEM SANITIZATION

Over time and use, the plumbing downstream from the system may require sanitization. It is recommended that the system and downstream plumbing be sanitized at least once a year. When necessary, follow the Sanitizing the System and Lines procedure in the Installation section of this manual.

TROUBLESHOOTING

Problem	Possible Cause	Corrective Action
Unit does not have power.	The power cord is not correctly plugged in.	Plug power cord in correctly.
The Control Display is blank.	The power cord is not correctly plugged in.	Plug power cord in correctly.
	Control Board is inoperable.	Contact your maintenance person or Authorized Service agency.
	Transformer is inoperable.	
No water comes out of the filter system	Inlet Valve closed	Open the Inlet Valve
	Inlet Strainer is plugged	Clean/replace Inlet Strainer
	End of the capillaries plugged	Clean/replace Filter Cartridge
Low water flow/pressure out of system	See above.	See above.
	The system may be in a flush cycle.	Wait for the flush cycle to end.
	Flushing program not set correctly for water conditions.	Decrease the flush interval and increase the flush duration (refer to the Operation section of this manual).
	Drain Valve is stuck open.	Replace/rebuild the Drain Valve.
	The inlet water pressure is too low.	Boost the inlet water pressure/replace pipes.
Water tastes bad.	Storage/shipping solution not completely flushed out of system.	Flush system for a longer period of time.
	Biological growth in pipes.	Sanitize plumbing.
	Water conditions changed.	Consider installing taste and odor filtration.
	Broken capillary in Filter Cartridge.	Replace Filter Cartridge.
Flush runs continuously.	Drain Valve stuck open.	Replace/rebuild the Drain Valve.
	Controller sending continuous signal to valve.	Replace the controller.
Flush runs too long.	Program duration set too long.	Re-program the unit to flush for a shorter duration of time.
Flush occurs at time of high water usage.	The Flush Interval is set to interfere with water use.	Change Flush Interval/reprogram time. Unplug unit and plug in at a time of lower water usage.
Water splashes at drain during flush.	Drain line not positioned properly.	Reposition the end of the drain line.
Water leaks at the ends of the Filter Cartridge after changing cartridges.	Cartridge end connections are not tight enough.	Tighten with strap wrench if necessary.
	O-rings not lubricated.	Lubricate O-rings with food-grade lubricant.
	O-rings are split, cut, or twisted	Replace O-rings.
Water leaks from Permeate port.	Permeate port is not tight enough	Tighten, with strap wrench if necessary.
	O-ring not lubricated.	Lubricate O-ring with food-grade lubricant.
	O-ring split, cut, or twisted.	Replace O-ring.
Water leaks from system fitting or connection.	Fitting broken or loose.	Retighten or replace the fitting.
	Not enough pipe thread sealant used.	Redo the fitting with the proper amount of sealant.

REPLACEMENT PARTS UFC-420/440

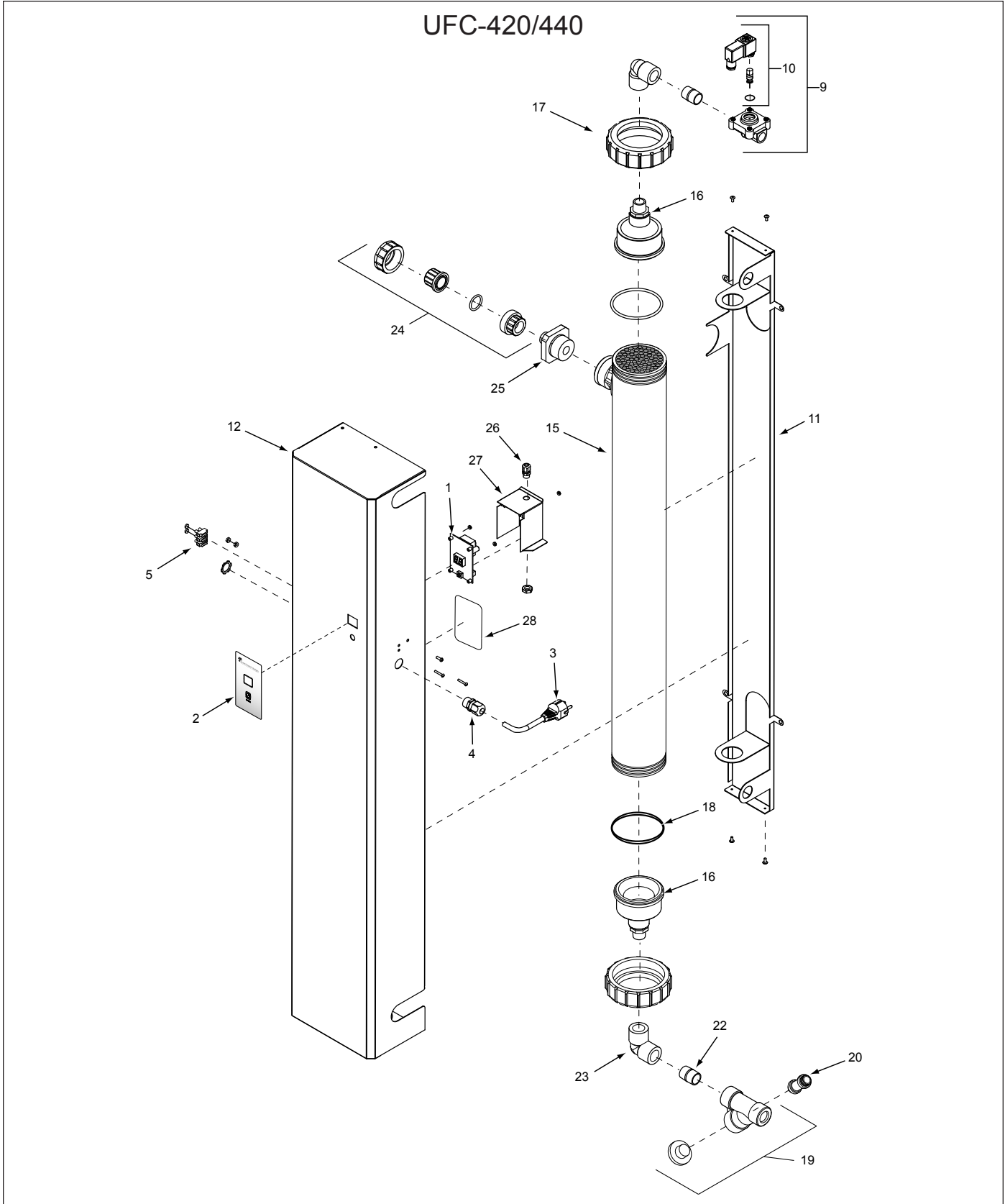

REPLACEMENT PARTS UFC-420/440 (continued)

Item No.	Part No.	Description	Qty.
1	4070058	Timer 120V	1
	4070059	Timer 230V	1
2	1001116	Label, Timer	1
3	0700463	Power Cord 5-15P (CF)	1
	0700634	Power Cord CEE 7/7 (HC)	1
4	0400251	Strain Relief, Power Cord	1
5	4060355	Terminal Block	1
9	4040173	Solenoid Valve 120V NC 3/4" NPT	1
	4040174	Solenoid Valve 230V NC 3/4" NPT	1
10	7000357	Solenoid Valve/Coil Kit 120V	1
	7000358	Solenoid Valve/Coil Kit 230V	1
11	0021323	Mounting Bracket Weldment (UFC-420)	1
	0021332	Mounting Bracket Weldment (UFC-440)	1
12	0021455	Main Housing Weldment (UFC-420)	1
	0021460	Main Housing Weldment (UFC-440)	1

Item No.	Part No.	Description	Qty.
15	2090122	Cartridge, Filter 4" x 20"	1
	2090123	Cartridge, Filter 4" x 40"	1
16	0011606	End Cap Union Connector Assy. 4"	2
17	2190127	Union, End Cap 4"	2
18	7000405	"O" Ring End Cap Union	2
19	2190123	"Y" Strainer 3/4" NPT	1
20	2090126	Screen, "Y" Strainer 3/4" NPT	1
22	2070117	Close Nipple 3/4" NPT	2
23	2190126	90° Elbow 3/4" NPT	2
24	2190141	Union, Adaptor 3/4"	1
25	2190131	Adaptor 1-1/4" to 3/4" (UFC-420)	1
	2190139	Adaptor 1-1/2" to 3/4" (UFC-440)	1
26	7000361	Strain Relief Kit	1
27	0503921	Splash Guard	1
28	1001101	Label - Wiring Diagram	1

** Only available in quantities of 10.*

RECOMMENDED EQUIPMENT SCHEMATIC

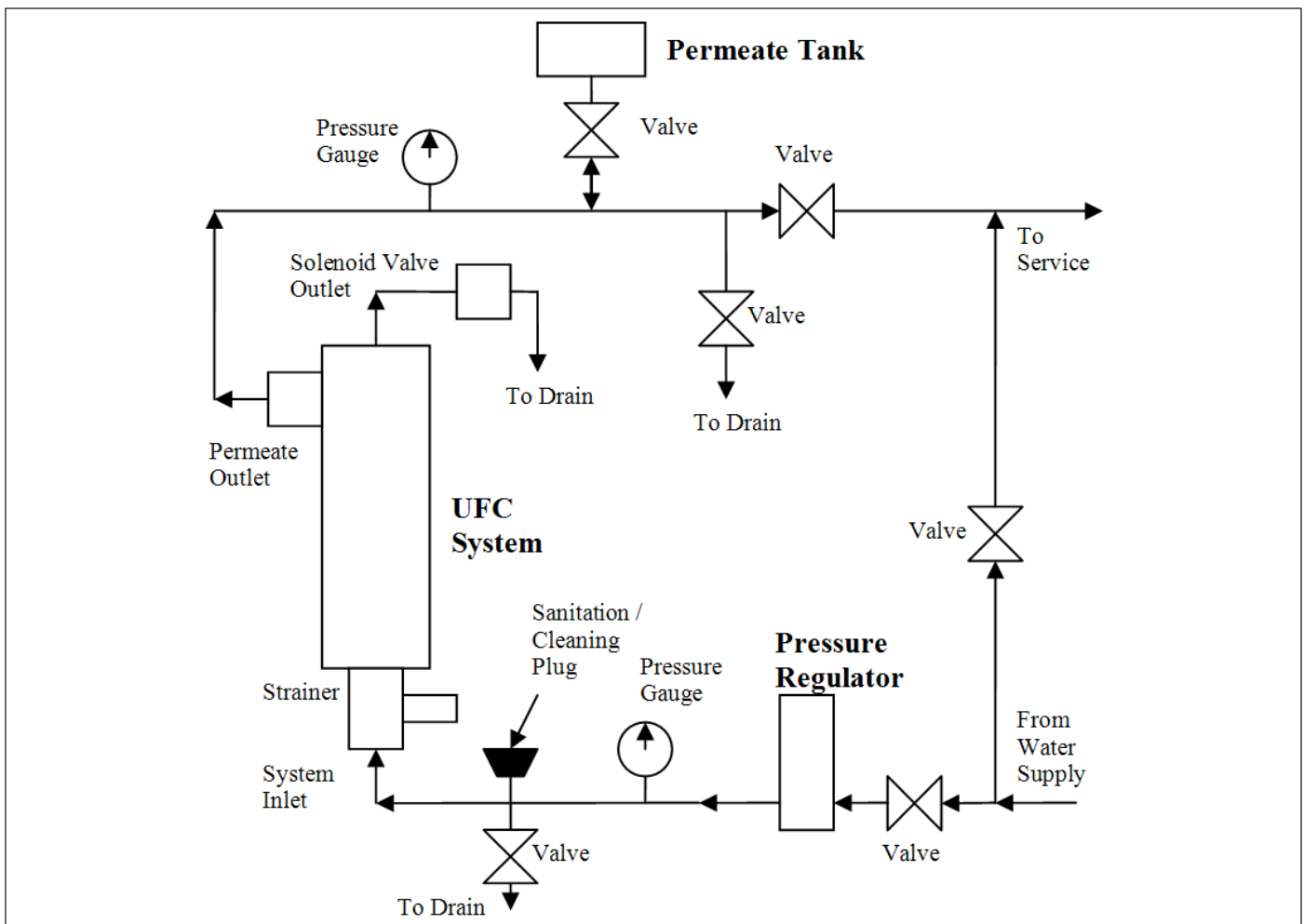

WIRING DIAGRAM

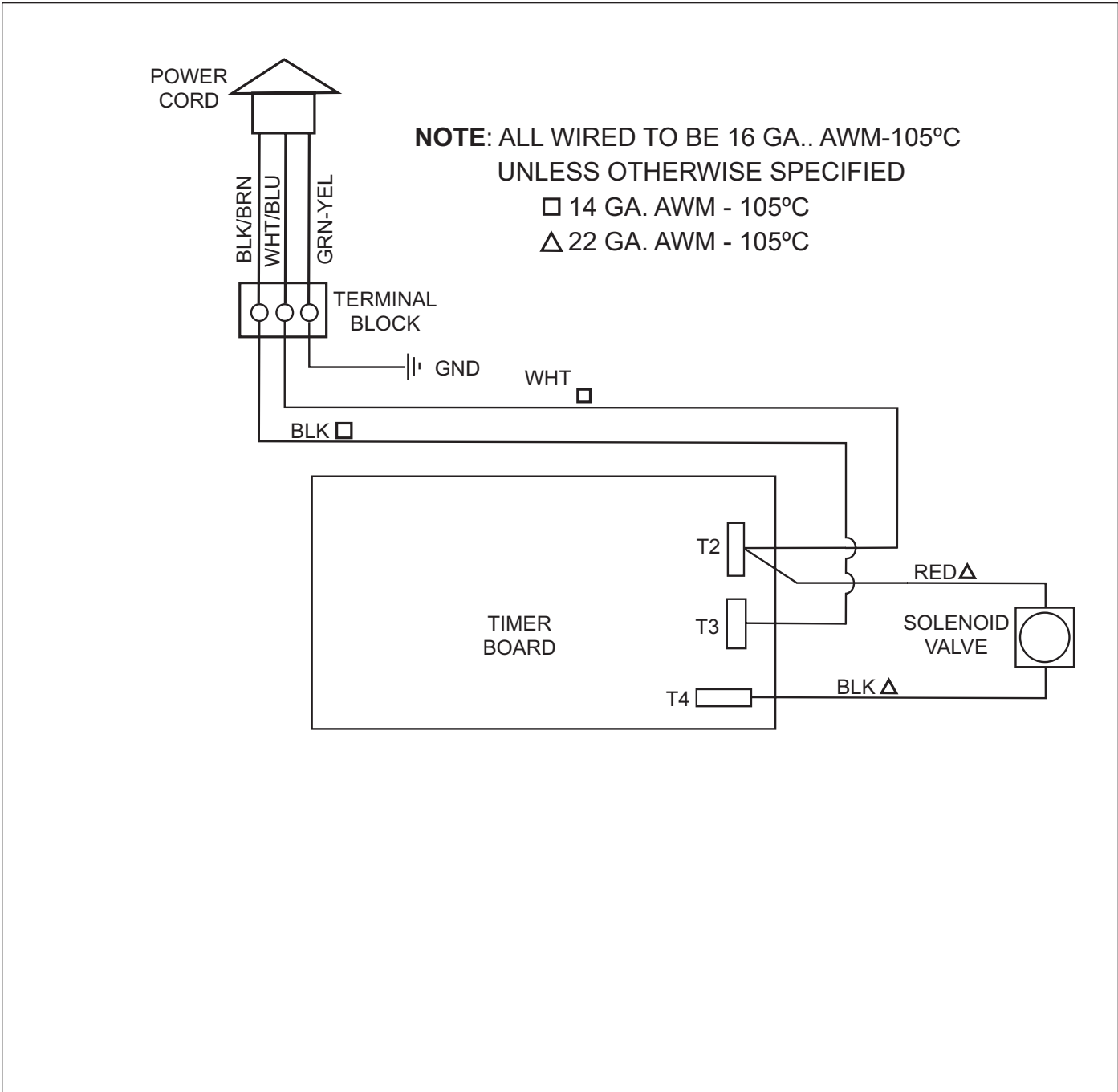

LIMITED WARRANTY

Equipment manufactured by A.J. Antunes & Co. has been constructed of the finest materials available and manufactured to high quality standards. These units are warranted to be free from defects in materials and workmanship for a period of one year from date of purchase under normal use and service, and when installed in accordance with manufacturer's recommendations*. The ultra filtration membrane cartridge is warranted under the same terms and conditions on a prorated basis for 24 months from date of purchase.

*To ensure continued proper operation of the units, follow the maintenance procedure outlined in the Owner's Manual.

1. This warranty does not cover failures due to improper system installation, defects caused by improper storage or handling prior to placing of the equipment into service. This warranty does not include overtime charges or work done by unauthorized service agencies or personnel. This warranty does not cover normal maintenance, calibration, or regular adjustments as specified in operating and maintenance instructions of this manual, and/or labor involved in moving adjacent objects to gain access to the Equipment.
2. A.J. Antunes & Co. reserves the right to make changes in design or add any improvements on any product. The right is always reserved to modify equipment because of factors beyond our control and government regulations. Changes to update equipment do not constitute a warranty charge.
3. **If shipment is damaged in transit, the purchaser should make a claim directly upon the carrier. Careful inspection should be made of the shipment as soon as it arrives and visible damage should be noted upon the carrier's documentation. Damage should be reported to the carrier. This damage is not covered under this warranty.**
4. THIS WARRANTY IS EXCLUSIVE AND IS IN LIEU OF ALL OTHER WARRANTIES, EXPRESSED OR IMPLIED, INCLUDING ANY IMPLIED WARRANTY OR MERCHANTABILITY OR FITNESS FOR A PARTICULAR PURPOSE, EACH OF WHICH IS HEREBY EXPRESSLY DISCLAIMED. THE REMEDIES DESCRIBED ABOVE ARE EXCLUSIVE AND IN NO EVENT SHALL A.J. ANTUNES & CO. BE LIABLE FOR SPECIAL CONSEQUENTIAL OR INCIDENTAL DAMAGES FOR THE BREACH OR DELAY IN PERFORMANCE OF THIS WARRANTY.

Prices and specifications are subject to change without notice.



A.J. Antunes & Co.

We exist to make our customers successful.

A.J. Antunes & Co.
Headquarters/Manufacturing
Carol Stream, Illinois 60188 USA
Phone: (630) 784-1000
Toll Free: (800) 253-2991
Fax: (630) 784-1650

Antunes Equipment
Manufacturing (Suzhou) Ltd.,
Suzhou, Jiangsu, China 215011
Phone: 86-512-6841-3637
Toll Free: 400-0-7878-22
Fax: 86-512-6841-3907

www.ajantunes.com