

Power Soak[®]

Service Manual

PS-275



Intentionally blank page

Table of Contents

Introduction – Section 1	2
1.0 Product Introduction	2
1.1 General Description	2
Messages – Section 2	3
2.0 Explanation of Warning Messages	3
2.1 Danger	3
2.2 Warning	3
2.3 Chemical Hazard	3
2.4 Personal Injury Hazard	3
Detergents and Sanitizer – Section 3	4
3.1 Detergents	4
3.2 Sanitizers	4
3.3 Factory Assistance	4
Preventative Maintenance - Section 4	5
4.0 Maintenance	6
4.1 Daily	6
4.1a Clean the liquid level sensors	6
4.2 Monthly	6
4.2a Clean the motor fan shroud	6
4.2b Clean the Heating Element	6
4.3 Quarterly or as needed	6
4.3a De-lime the wash sink	6
Control Panel Lights - Section 5	7
5.1 Control Panel Overlay	8
5.2 Light Illumination Code	8
5.3 Green Status Light	10
5.4 Power Light	10
5.5 Error Light	10
5.5a Error Codes	11
Liquid Level Error	11
Temperature Sensor Error	11
Over Current Error	11
Over Temperature Error	11
Current Sensor Error	11
Membrane Error	12

5.6 Blue Wash Tank Light	12
5.7 Red Sanitizer Tank Light	12
5.8 Green Unload/Load Light	13
5.9 Deep Cleaning Mode Lights	13
5.9a High Wash Fluid Temperature	13
5.9b Deep Cleaning Mode Active	13
Control Panel Components - Section 6	Authorized
Personnel Only	15
6.0 Universal Programming Module (UPM)	16
6.1a Programming Interface	17
6.1b Membrane Encoder	18
6.2 Communication Port	19
6.3 Alert Lights	19
6.4 Triac Relay	19
6.5 Power Transformer	21
6.6 Contactor	22
6.7 Load Sensor	22
6.8 Fuse Holder, Terminal Blocks and Jumpers	23
6.9 Push Button Membrane	24
Electrical Components - Section 7	Authorized
Personnel Only	25
7.1 Pump Motor	26
7.2 Motor Thermo-disc	26
7.3 Heating Element	27
7.4 Heating Element Thermo-disc	29
7.5 Thermistor	29
7.6 Liquid Level Sensors	30
Assembly Procedures - Section 8	
Authorized Personnel Only	31
8.1 Motor and Pump	32
8.1a Disassembly	32
8.1b Inspection	32
8.1c Assembly	33
8.2 Heating Element	34
8.2a Disassembly	34
8.2b Inspection	34
8.2c Assembly	35
8.3 Sensor Pad	36

8.3a Disassembly	36
8.3b Inspection	36
8.3c Assembly	36
8.4 Chemical Dispenser (Optional)	36
Troubleshooting - Section 9.....	37
9.1 The pump will not start when the green “START” button is pushed.	38
9.1a. Control panel white POWER light is not on.	38
9.1b. Control panel white POWER light is on.	38
9.1c. Control panel POWER (white) light is on, STATUS (green) light is on and WASH TANK (blue) light is on.	38
9.1d. Control panel POWER (white) light is on, STATUS (green) light is on and SANATIZER TANK (red) light is on.	38
9.1d. Control panel STATUS light and ERROR are blinking with a pattern of long and short flashes.	39
9.1e. All of the lights on the control panel and all of the Alert Lights are flashing.....	39
9.2 Motor starts, but makes noise.	39
9.3 Motor starts, but no water flows in the wash tank.....	40
9.4 The control circuit fuse “blows” when the power is turned on.....	40
9.5 The lights indicate that the tank is empty when it is actually full.....	40
9.6 The water gets too hot and stops the machine.....	41
9.7 The chemical dispenser pump runs, but does not pump the chemical...41	
Parts Lists – Section 10.....	42
10.1 Motor and Pump Assembly	43
10.1a Parts list.....	43
10.1b 60 Hz Motor and Impeller	44
10.1c 50 Hz Motor and Impeller.....	44
10.1d Pump Parts Common to all Assemblies.....	44
10.1e Seal Kit	44
10.2 Heater & Sensor Block	45
10.3 Control Panel	46
10.4 Decal Locations and Part Numbers.....	47
10.4a Unit with Left to Right Work Flow.....	47
10.4b Unit with Right to Left Work Flow.....	47
Appendix	49
Other PS-275 Manuals and Related Component Manuals	50
Wiring Diagrams.....	50
Electric Wiring Diagram – Single Phase	51
Electric Wiring Diagram – 3 Phase	52
AWI Insert Diagram.....	53

COPYRIGHT © 2012 METCRAFT INC.dba POWER SOAK
Reproduction of this manual is prohibited without
written consent from METCRAFT INC dba
POWER SOAK

Power Soak[®] 

Power Soak[®]

SECTIONS 1, 2 & 3

PS-275



Introduction – Section 1

1.0 Product Introduction

The Power Soak pot, pan and utensil washing system will provide years of dependable, efficient and trouble-free service. Every system is manufactured to last, with only high-quality, heavy-duty, 14 gauge stainless steel used in its construction. All electrical components used in a Power Soak system are of the highest quality. The faucets and drains are designed for quick filling and emptying of the system's tanks.

Most Power Soak systems are provided with a limited 3 year parts and labor warranty. To inquire about the warranty status of a PS-275 Power Soak, please call the following number and have the serial number of the machine available at the time of the call:

Power Soak Systems

(800) 444-9624

The people at Power Soak Systems take pride in manufacturing the Power Soak equipment and are committed to standing behind Power Soak customers and products 100%.

1.1 General Description

The Power Soak PS-275 can be built with many variations to meet the needs of Power Soak customers. The illustrations shown in this document cannot match all the possible machine configurations, however; the information will apply even if a machine does not match the illustration. The general configuration of a machine will start the work flow in the scraping area and/or wash tank and finish in a sanitize tank and/or on a drain board. The units that start with the scraping area and/or wash tank on the left are referred to as a “left to right” or “left hand” unit. A “right to left” or “right hand” unit will start with the scrap area and/or wash tank on the right hand side.

Messages – Section 2

2.0 Explanation of Warning Messages

Be sure to read, understand and follow all DANGER, WARNING, and CAUTION messages located in this document and on the equipment. These messages are used to identify areas of the machine that are harmful.

2.1 Danger

Personal Injury and Property Damage hazard.
Will result in serious injury or death.
Will cause extensive equipment damage

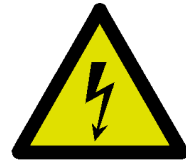

2.2 Warning

Property Damage Hazard.
Will result in property or equipment damage.



2.3 Chemical Hazard

Will result in serious injury or death.

Instructions, labels and Material Safety Data Sheets (MSDSs) are to be supplied with all detergents and sanitizing chemicals. The manufacturers, importers and distributors of the cleaning chemicals are responsible for providing this information.



Power Soak Systems, Inc. is not a chemical manufacturer, importer or distributor. Power Soak Systems, Inc. can assist the chemical representative but will not make specific brand recommendations.

2.4 Personal Injury Hazard

Hazard from sharp objects.
Will result in serious injury or death.



Detergents and Sanitizer – Section 3

3.1 Detergents

Power Soak machines require a low-foaming and recommend a metal/aluminum-safe detergent. The detergent should have good grease cutting abilities and pH level that is safe for human contact. Improper detergents may damage the equipment. Use of the correct detergent in the Power Soak PS-275 is critical to its washing performance. If there are problems with cleaning results, please contact Power Soak Systems (1-800-444-9624).

Detergents with high or low pH level will damage the equipment and be harmful to human contact. Consult with a chemical manufacturer representative for recommendations on the selection of detergents.



3.2 Sanitizers

A "chemical sanitizing" method is used in the Power Soak system. There are a number of products on the market that work well in this application. A chemical sales representative should assist in selecting the proper sanitizer for each application. Check with a cleaning chemical provider to determine the detergent concentration, sanitizer "parts per million" (ppm) and sanitizer submersion times that will meet local health codes.

3.3 Factory Assistance

If a chemical sales representative is having difficulty selecting a detergent or sanitizer, or if there are poor results with the chemicals that have been recommended, please contact a Power Soak representative at:

1-800-444-9624.

Power Soak[®]

Preventative Maintenance - Section 4

PS-275



4.0 Maintenance

Power Soak machines require minimal preventive maintenance. To ensure that the Power Soak PS-275 remains reliable, the following tasks should be completed at the intervals shown in this section.

4.1 Daily

4.1a Clean the liquid level sensors - The liquid level sensors are located on the side walls of the wash and sanitizer tanks (see section 7.4). They are white plastic discs with metal centers. The faces of the sensors need to be cleaned with a washcloth and soapy water. Regular cleaning will prevent a build-up of difficult to remove chemicals and debris.

The liquid level sensors must be cleaned regularly in order for the machine to operate correctly. Dirty sensors can allow the pump motor to operate without water in the wash tank, which will cause serious damage to the unit.



4.2 Monthly

4.2a Clean the motor fan shroud - The motor fan shroud is the "vented" cover located at the end of the motor closest to the control panel. Shut off the electrical supply at the electrical circuit breaker located in the wall mounted enclosure. Clean the pump motor fan shroud with a stiff bristle brush and a vacuum. If a brush and vacuum are unavailable, clean the shroud with a damp, soapy cloth. This will prevent grease and dust from accumulating in the openings of the cover and obstructing the airflow that cools the motor.

4.2b Clean the Heating Element - Shut off the electrical supply at the system's electrical circuit breaker located in the wall mounted enclosure. Remove the cover plate located in the slanted surface of the back wall of the wash tank. Remove debris that has collected in and around the heating element. Install the cover plate when cleaning is completed. The cover plate must be installed after cleaning to prevent foreign objects from entering the pump suction and causing damage to the pump.

Failure to shut off the electrical supply will result in personal injury, including serious injury or death, and extensive equipment damage.



4.3 Quarterly or as needed

4.3a De-lime the wash sink - Select a de-liming agent that is safe for plastics and stainless steel sinks. Follow the instructions on the package for mixing and fill the tank with water. Turn on the pump motor to circulate the mixture in the tank and pump manifolds.

Power Soak[®]

Control Panel Lights - Section 5

PS-275



5.1 Control Panel Overlay

The Control Panel Overlay is bonded to the surface of the enclosure door and conceals the membrane that contains the push buttons and lights. The panel lights are used to indicate conditions that have been detected by the operating program. The lights on the face of the control panel operate in conjunction with the Alert Light System located on the bottom surface of the control box (lights that shine on the floor). There are some conditions that are indicated by the control panel lights which are not part of the Alert Light System. The operator should review the control panel lights when determining the operating situation of the machine. See the chart in section 5.2 for interpreting the light combinations.

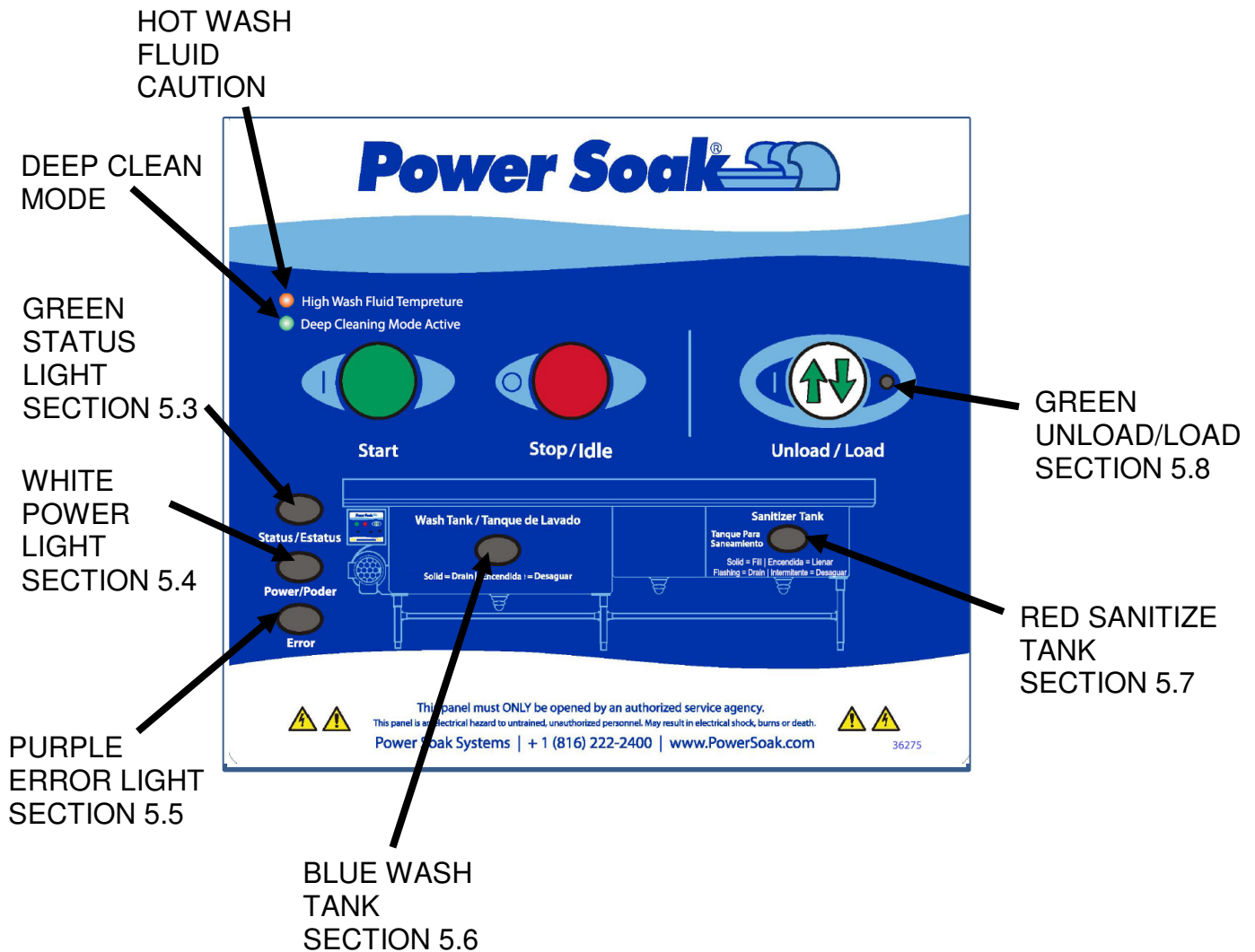

5.2 Light Illumination Code

CONDITION INDICATED BY LIGHTS															
The power turned to the machine is OFF or the transformer in the control panel has failed															
		Power is on, no program running (flashing is at a constant rate)	Wash Program is running (pump may be off)	Fluid life in wash tank has expired	Fill or change fluid in wash tank (wash will not operate)	Fluid life in sanitize tank has expired (flash rate increases as time expires)	Fill or change fluid in sanitize tank	Wash tank is near full or full (flash rate increases when top sensor is reached)	Sanitizer tank is near full or full (flash rate increases when top sensor is reached)	Sanitizer life has expired and wash tank is "locked out" (Programming option)	Wash period is finished	Unload/Load wash tank	Low voltage from the transformer		
	Control Panel Lights														
	All lights are turned off	Status - Green	Flashing (constant)	On	On	On	On	On	Flashing (variable)	Flashing (variable)	On	On	On	Flashing	
		Wash Tank - Blue			Flashing (variable)	ON			Flashing (variable)		Flashing (variable)			Flashing	
		Sanitize Tank - Red					Flashing (variable)	ON		Flashing (variable)	Flashing (variable)			Flashing	
		Load/Unload - Green										Flashing	ON	Flashing	
		Power - White	ON when the power is applied to the machine and the transformer in the control panel is producing 24VAC. When there is power to the machine and the light is OFF, it indicates a transformer failure.												
		Error -Purple	The Error light will flash a pattern that indicates the type of operating error, see the section 5.5a for the Error Codes.												
		Alert Light System													
		Green								Flashing (variable)	Flashing (variable)		Flashing	ON	Flashing
		Blue			Flashing (variable)	ON				Flashing (variable)		Flashing (variable)			Flashing
		Red					Flashing (variable)	ON			Flashing (variable)	Flashing (variable)			Flashing
Orange		The orange beacon illuminates when the Deep Cleaning Mode is elevating the wash fluid temperature for the Deep Cleaning operation. The beacon will flash when the fluid temperature in the wash tank is above 120°F indicating that the wash fluid temperature is uncomfortable for human contact.													

N:\Parts\37137179\PS-275 Light Sequence.xlsx

5.3 Green Status Light

Off – Power to the machine is turned off or an over temperature situation has occurred.

Slow Flashing – “POWER ON” – system is energized and ready to fill the wash tank.

Solid Illumination – “OPERATING” – wash tank is full; START button has been pressed, the program is running. (Note: if the Stop button is pressed, the program is still running even if the wash action is stopped, pressing the START button will start the wash action) The wash solution must be drained from the wash tank to exit the operating program.

Flashing with another light – indicating a message, see the chart in section 5.2.

Flashing a repeating “long & short” pattern – error has been detected, see error codes in section 5.5a

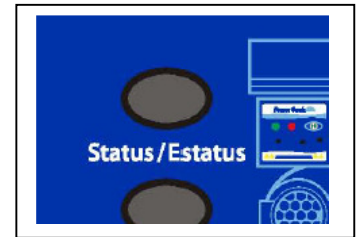

5.4 Power Light

ON – Electrical power is connected to the PS-275 and the transformer inside the control panel is producing the appropriate 24 VAC.

OFF – The power supply to the PS-275 is turned off or the transformer inside the control panel has failed.



5.5 Error Light

The error light is used to flash a code that indicates the type of failure that has been detected by the UPM. Section 5.5a identifies the meaning of the flashing sequence.

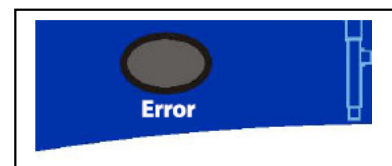

5.5a Error Codes

Certain conditions create errors in the program operation. The purple ERROR light on the front of the control panel along with the ERROR CODE light on the UPM will blink in patterns to indicate the source of the error. The definitions for the patterns are as follows:

“-” symbol represents a “long” flash	
“.” symbol represents a “short” flash	
3 long & 1 short	— — — . = Liquid Level Error
3 long & 2 short	— — — . . = Temperature Sensor Error
3 long & 3 short	— — — . . . = Over-Current Error
3 long & 4 short	— — — = Over Temperature Error
3 long & 5 short	— — — = Current Sensor Error
3 long & 6 short	— — — = Membrane Error

Liquid Level Error – This error appears when the upper liquid level sensor sends a signal to the UPM (W-H light is illuminated) and the low liquid level sensor is not sending a signal to the UPM (W-L is not illuminated). The low level sensor may not be functioning due to a coating of debris or a broken/disconnected wire that is preventing the signal to the UPM. A continuous signal from the upper level sensor can be caused by debris coating the face of the sensor or faulty wiring that has the sensor connection grounded to the wash tank when there is no fluid in the tank. The liquid level lights on the UPM can be used to help determine the problem (see Section 6.0 UPM & Section 7.6 Liquid Level Sensor).

Temperature Sensor Error – When the UPM receives a signal from the thermistor (see Section 7.5 Thermistor) that is outside the range of the UPM programming, the temperature sensor error will actuate.

Over Current Error – If any of the high voltage components begin drawing excessive current, the current sensor will send a signal to the UPM to start the Over Current Error and deactivate the contactor which turns the power off to the machine (see Section 6.6 Contactor & Section 6.7 Load Sensor).

Over Temperature Error – If the fluid temperature in the wash tank exceeds 135°F it will activate this error message and stop the machine. This error code cannot be reset until the fluid is drained below the low level sensor in the wash tank.

Current Sensor Error – The UPM must receive a signal from the current sensor to verify that it is connected and working. If it does not receive the signal, the UPM program will stop the machine and give this error code (see Section 6.7 Load Sensor).

Membrane Error – In the event that one of the control panel buttons sends a constant signal to the UPM, the program will recognize that the membrane is defective and display this error code (see Section 6.9 Push Button Membrane).

Please have the “Error Code” information and serial number of the machine available when calling Power Soak Systems for telephone assistance (1-800-444-9624). The machine serial number will be used to identify the configuration of the machine. The serial number is 5-6 digits long and located on the identification tag which is on the lower corner of the wash tank close to the control panel enclosure.

Note: There are periods of unstable power from the incoming power source that can cause a false error. Turning the electrical power off and on can reset the program if it is a power source fluctuation that caused the error. Locate the wall mounted circuit breaker box, turn the circuit breaker for the Power Soak machine off, pause for 15 seconds, turn the circuit breaker back on, and then check to see if the error code has cleared.

5.6 Blue Wash Tank Light

Solid Illumination – “CHANGE WASH SOLUTION” the wash cycle will be stopped until the wash tank is completely drained and refilled.

Slow to Fast Flashing – wash solution life is expiring, 15 minute warning prior to solid illumination.

Flashing with Green Status light – occurs when tank is filling with water indicating near full, rapid flashing indicates that the tank is full (NOTE: the fill indication feature is an option that must be selected in the UPM settings, see programming manual 37193.)



5.7 Red Sanitizer Tank Light

Solid Illumination – “FILL SANITIZER TANK” – sanitizer tank must be filled to the waterline.

OR

Solid Illumination – “CHANGE SANITIZE SOLUTION” – After two hours, the sanitizer tank must be drained and refilled.

Slow to Fast Flashing – wash solution life is expiring, 15 minute warning prior to solid illumination.

Flashing with Green Beacon light – occurs when tank is filling with water indicating near full, rapid flashing indicates that the tank is full (NOTE: the fill indication feature is an option that must be selected in the UPM settings, see programming manual 37193.)



5.8 Green Unload/Load Light

Flashing – wash period is complete, time to unload the items from the wash tank (press the **Load/Unload** button to pause the unload timer).

Solid – unload timer is paused (press the **Load/Unload** when the unloading is complete to restart the timer).

(NOTE: Proper operation of the **Load/Unload** button according to the flashing of the green light along with keeping the wash tank continuously operating will extend the wash solution life. Improper use of the **Load/Unload** button will shorten the wash solution life).

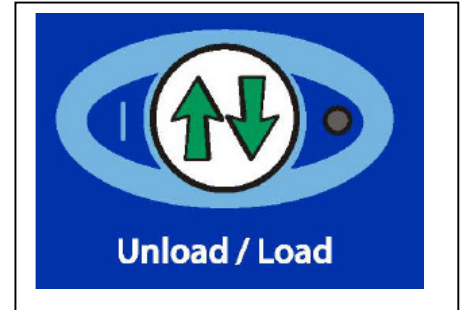

5.9 Deep Cleaning Mode Lights

5.9a High Wash Fluid Temperature

ON – The temperature of the cleaning solution in the wash tank has reached 120°F.

FLASHING – The fluid temperature in the wash tank is above 123°F and will be uncomfortable to touch.

5.9b Deep Cleaning Mode Active

OFF – The Deep Cleaning Mode is not operating.

ON – The deep cleaning mode has been selected and the deep cleaning programming is controlling the operation of the PS-275. (Note: If the sanitizer tank is full, the sanitizer timer will continue to operate. When the sanitizer time period is complete, the sanitizer indicator lights will operate but the “lockout” will automatically be turned off and allow the wash tank to continue to operate. The fluid should be drained from the sanitizer tank at this time. Draining the sanitizer tank will turn off the sanitizer tank lights.)

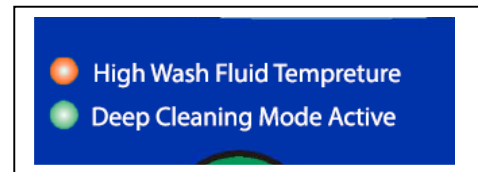

Intentionally blank page

Power Soak®

Control Panel Components - Section 6 Authorized Personnel Only

PS-275

AUTHORIZED SERVICE AGENCY

This section contains procedures that are to be performed only by authorized service personnel. DO NOT attempt to do these procedures without proper training. To obtain information for a recommended service agent, please call the Power Soak Service Department at 1-800-444-9624.



6.0 Universal Programming Module (UPM)

The Universal Programming Module is located on the inside of the control panel door. To access the UPM, remove the two screws at the top of the control panel door and swing the door down toward the floor.

The open door exposes high voltage terminals in the enclosure. DO NOT touch the electrical terminals with hands or tools.



PROGRAMMING INTERFACE

UPM

The UPM has four indicator lights for troubleshooting:

POWER ON

Light is on when operating.

ERROR CODE

Flash sequence indicates error. See section 5.5a for error codes.

LIQUID LEVEL W-L

Light is on when wash tank low level sensor is activated.

LIQUID LEVEL W-H

Light is on when wash tank high level sensor is activated.

LIQUID LEVEL S-L

Light is on when sanitizer tank low level sensor is activated.

LIQUID LEVEL S-H

Light is on when sanitizer tank high level sensor is activated

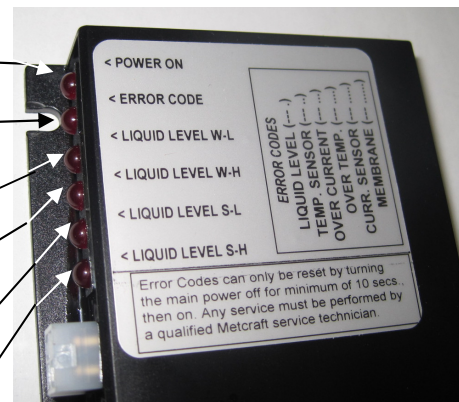

UPM Removed from the machine for clarity.

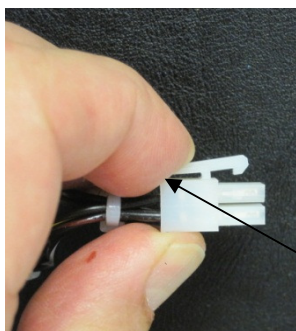

The UPM is replaced by unplugging the cables and removing the mounting screw in each corner of the mounting flange. The two white cable connectors have a hook that keeps them secured to the socket. The back edge of the hook must be depressed to allow the connector to be separated from the socket. The white connectors are manufactured so that they only plug into the socket when oriented correctly.

Press the back edge of the hook to unplug the connector from the socket.

Identification of the UPM connector terminals is helpful for troubleshooting. Disconnecting the wiring harness connector and conducting voltage or ohm measurements on the terminals in the connector will help determine the condition of the components connected to the wiring harness. The pin numbers are identified on the schematic for determining the component connections.

The 24 pin connector for the UPM is identified on the schematic as “J1”. It carries the majority of the communication signals to and from the UPM. The connector is designed so that it can only be connected in the correct orientation. Identification of the pin numbering is shown below.

Pin 24 is located in the upper right corner when facing the connector. The upper row is numbered 13 thru 24

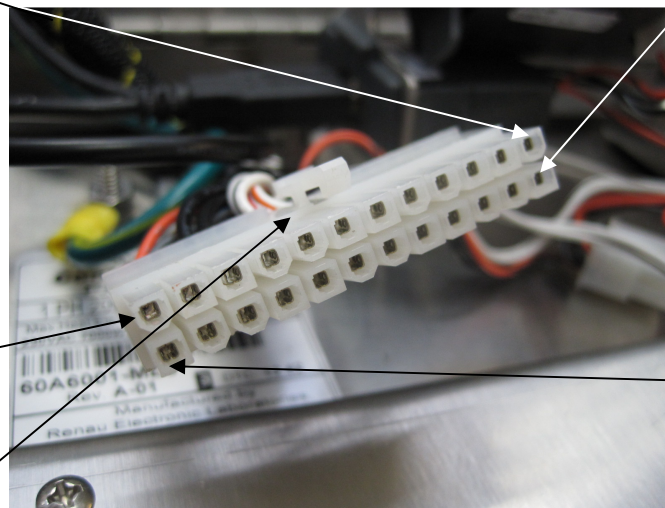

Pin 12 is located in the lower right corner when facing the connector. The lower row is numbered 1 thru 12

Pin 13 is located in the upper left corner when facing the connector

Pin 1 is located in the lower row on the left corner when facing the connector

Orient the connector with the clip on top as shown

6.1a Programming Interface

The programming interface allows direct access to the settings in the UPM operating program. The functions in the program can be turned adjusted to tailor the machines operation to a specific application. The timers can be adjusted to coordinate with functions such as the fill rate of the wash and sanitizer tanks. Explanation for how to set these control functions and timers is located in the programming manual number 37193.

The programming interface is installed in the mounting bracket by separating the outer case from the inner frame. Press the thumb tabs toward the center of the case, and then pull the outer case away from the front face.

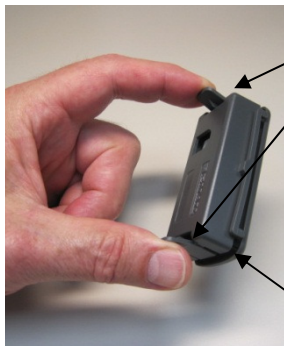

Tabs

To separate the interface unit for mounting, squeeze the tabs on the end of the case and pull on the back edge of the mounting flange.

Back edge of the mounting flange



Separated for mounting

6.1b Membrane Encoder

The membrane encoder is located next to the UPM and is used to translate inputs and outputs between the control panel overlay and the UPM. The ribbon cables from the overlay and a four pin connector routed from the UPM harness plug into the face of the encoder. The four pin connector is “keyed” so that it will only insert into the socket if it is oriented correctly. The ribbon cables from the overlay can be installed incorrectly and must be properly oriented as described. Keeping the ribbon cables flat (no twists in the cable), plug the large connector onto the inner row of pins, making sure that the connector slides over all the pins. The middle size connector slides onto the outer row of pins and connects to the first four pins that are closest to the outer edge of the encoder (see illustrations). The smallest connector attaches to a two pin connector that is part of the wiring harness. The orientation of the two pin connection is not important.

Large connector slides over all the pins on the inner row
Four pin connector

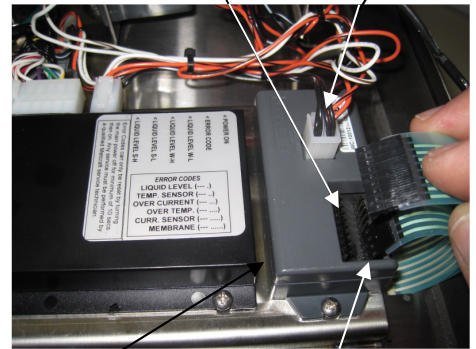

Middle size connector slides over pins on outer row.

Membrane Encoder

Smallest connector plugs into the wire harness

The cables from the overlay membrane should be a tight fit onto the pins. The connectors should not slide on or off the pins easily. The tight fit is what keeps the connectors plugged into the components. The tight fit also makes it difficult to unplug the connectors.

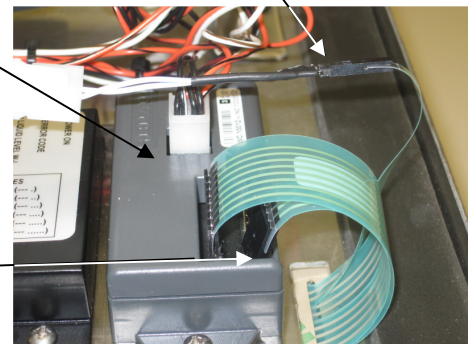

The middle size connector plugs into the pins at the end of the outer row of pins

6.2 Communication Port

A communication port (USB “A” style) is located on the bottom of the control panel enclosure and connected to the UPM by a cable. The connection port is protected by a cover that screws on to the body of the connector. The operating program is loaded into the UPM or copied from the UPM by using this port. Inserting a blank USB Flash Drive into this port will activate the programming module to copy the operating program to the flash drive. Inserting a USB Flash Drive that contains an operating program will activate the UPM to load the program into the module, overwriting any program already contained in the UPM.

Communication port

6.3 Alert Lights

The Alert lights are inserted through holes in the bottom of the control panel box and are secured with a nut screwed onto the body of the light. A connector is plugged into each of the lights. The connector for each light has a wire with a colored stripe that matches the color of the light to which it is connected.

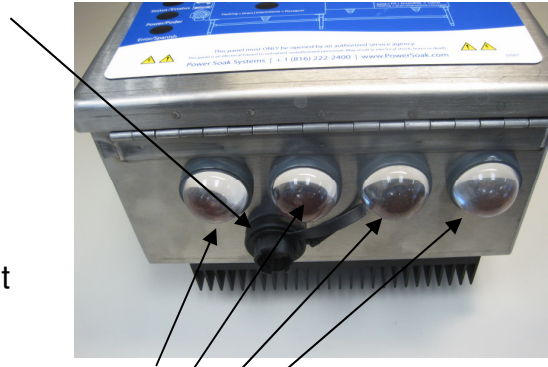

Alert lights on the bottom of the control panel

6.4 Triac Relay

Triac Relay is a solid state switch for connecting the high voltage to the pump motor and to the heater (not all machines have heaters). The Triac is a three terminal semiconductor for controlling current in either direction. The Triac is used similar to a contactor. When a gate voltage is applied from the UPM (similar to coil voltage on a mechanical contactor relay), the Triac conducts (closes) through the power terminals. On a single phase Control Panel, there are two Triacs, one for the Heater, the other for the Motor. Terminals 2 and 3 on each Triac are supplied with incoming voltage. On the top of these Triacs, they are labeled M1 (motor leg 1) and H1 (heater leg 1). On a three phase Control Panel there are four Triacs, two for the Heater, and two for the Motor. Two of these are labeled identically to the previous single phase panel description. The other two are labeled M3 (motor leg 3) and H3 (heater leg 3). Terminals 2 and 3 on each Triac are supplied with incoming voltage. To test the Triac, first verify the input voltage to the Triac. An LED on the Triac board illuminates when gate voltage is applied by the UPM. If this light is on, the Triac should be closed, and terminal 1 of the Triac should be supplying power to the respective device. If the LED is off, there should be no current on the output side of the Triac (voltage check on the output is not a valid test on a Triac).

The Triac relays are connected to high voltage electricity. The power to the machine must be turned off at the circuit breaker in the wall mounted enclosure when working on the Triacs. Failure to turn off the power will result in serious injury and possibly death.

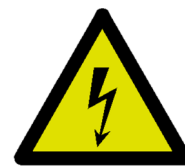

Triacs for 3 phase
Heater Control

Triacs for 3 phase
Motor Control

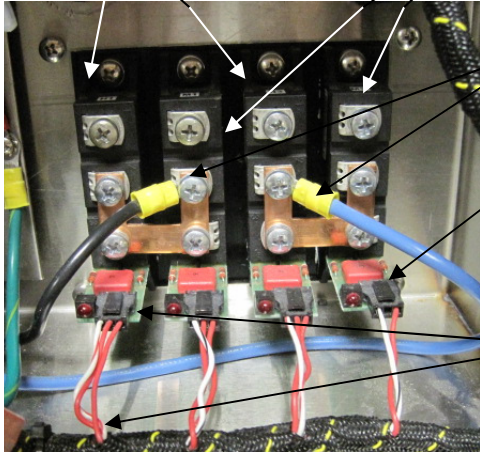

High Voltage Power Connections

Low Voltage Gate Connection

The connectors are matched to the gate connection according to the location in the wiring harness and the location of the gate connection.

Control Box with Triacs for 3 Phase Motor and Heater
(Alert Lights are not shown for clarity)

Gate Connections

Alert Light Connections

The unused signal connectors are tied to the wiring harness.

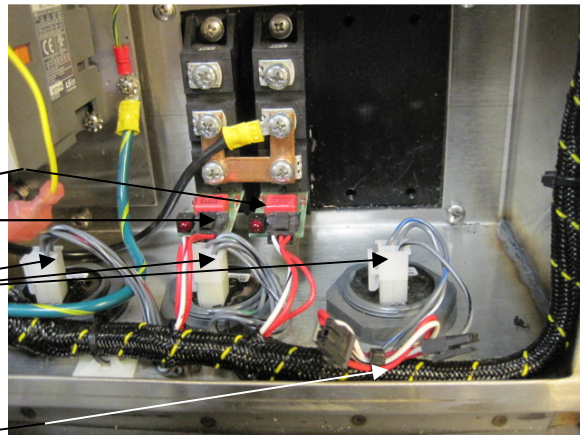

Control Box with Single Triac for Single Phase Motor and Heater

The wiring harness connectors for the Triac gates must be connected to the proper location. The connector location is matched to the gate connection by the location in the wiring harness. The first wire connector exiting the wiring harness will attach to the first gate connection on the heater control Triac. On a single phase machine or when a heating element is not used, the additional Triacs will not be installed and the connectors will be tied to the wiring harness. The connectors have a common connection that is in series with each of the connectors. When a connector is disconnected from a Triac, the connectors to the right of that connector will not operate.

The Triac relays are bolted to the heat sink which is mounted on the back of the control enclosure. When replacing a Triac relay, be sure that the mounting surface is clean and then apply thermal paste (provided with new triac) to the contact surface of the heat sink. The thermal paste will conduct heat in order to get the proper cooling of the relay.

6.5 Power Transformer

The power transformer, located in the upper left corner of the control enclosure, is used to convert the incoming high voltage to 24VAC with a 12VAC center-tap. The 12VAC is used for the thermal protection circuit while the 24VAC is used for control functions and the chemical dispenser. The transformer has multiple input voltage connections and must be connected for the correct voltage that is supplied to the machine. Three of the wire connections are made using a "crimp" connector. When replacing a transformer, new crimp connectors or wire nuts will be required. To test the transformer, verify that the input voltage is correct. This can be done between the L1 and L2 terminal connections. Verify the output voltage of the transformer by reading 24 volts across the yellow and orange output wires, and 12 volts between the center-tap (grey connected to black & white wires) and each of the other outputs. These voltages can be verified at the three wire nuts on the internal wiring harness near the Transformer. If a low voltage reading occurs, disconnect the output wires and check again. If the voltage returns to 24VAC then check other components for a connection to ground (short circuit).

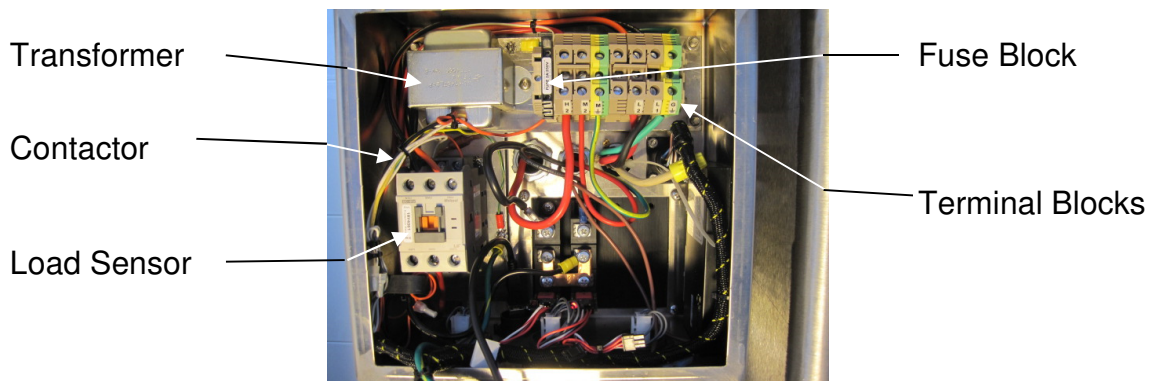

The transformer is connected to high voltage electricity. The power to the machine must be turned off at the circuit breaker in the wall mounted enclosure when working on the transformer. Failure to turn off the power will result in serious injury and possibly death.



6.6 Contactor

A mechanical contactor is used to disconnect the high voltage electrical supply from the Triacs when the UPM detects a problem with the pump motor or wash tank heater. The contactor is located on the left side of the mounting plate in the control enclosure. The contactor is defective if there is 20vac-28vac across the coil and the contactor does not pull the center button into the core. When the center button is pulled into the core and there is input voltage across terminals L1 and L2 (also L1-L3 and L2-L3, if three phase), but no voltage across terminals T1 and T2 (also T1-T3 and T2-T3, if three phase), the contactor is defective.

The contactor is connected to high voltage electricity. The power to the machine must be turned off at the circuit breaker in the wall mounted enclosure when working on the contactor. Failure to turn off the power will result in serious injury and possibly death.



6.7 Load Sensor

The high voltage wire leading to the heater and motor along with the coil wire for the contactor have been placed through the center of a load sensor. This device senses the amperage on the electrical supply to the components in order to detect an overload situation. In order for the sensor to function properly the smaller wire from the contactor coil must be wrapped three times through the center of the load sensor body. A plastic "zip tie" is tied around the high voltage wire to keep the sensor from sliding down the high voltage wire.

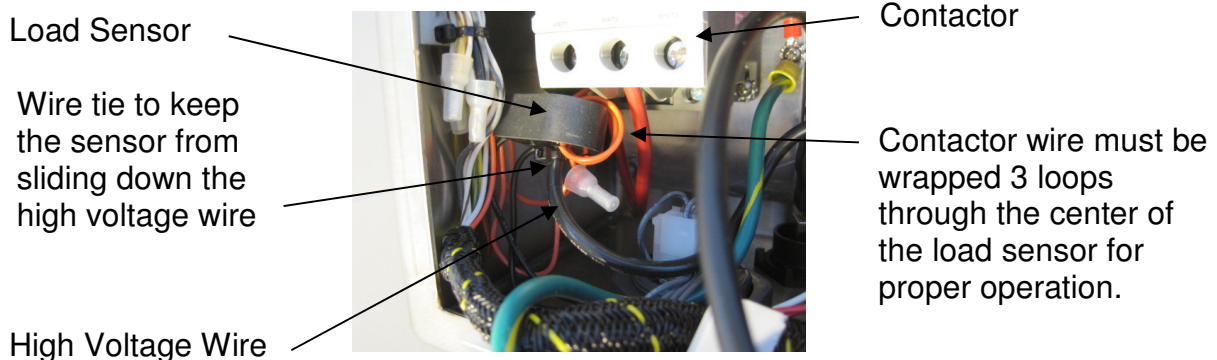

6.8 Fuse Holder, Terminal Blocks and Jumpers

A fuse holder with a 1 amp fuse for the 24VAC contactor control circuit and chemical dispenser pump is nested with the terminal blocks. When this fuse is “blown” or not present, the contactor will not connect the high voltage electricity to the pump motor or heater. The fuse is accessed by pulling out on the tab at the top edge of the fuse holder.

The electrical supply wires are to be connected to the terminal blocks. Some of the components of the machine are also wired to the terminal blocks. A jumper is used to connect specific terminal blocks to the adjacent terminal block so that wires connected to either terminal block are all connected together. The jumpers are arranged according to the electrical requirements for the heater and motor.

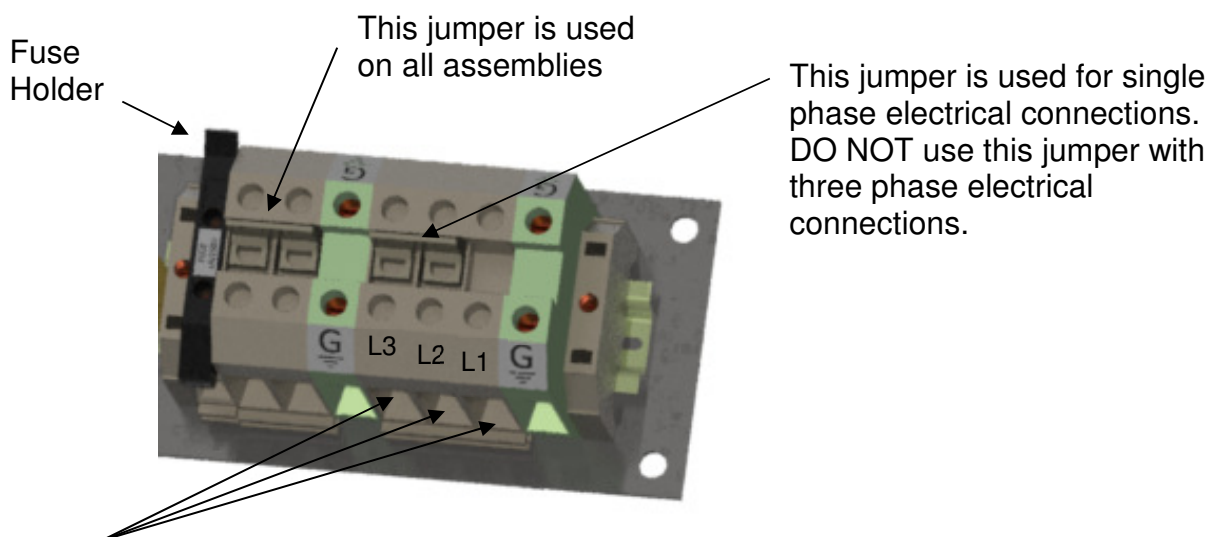

Connect the incoming electrical supply wires to the terminal blocks. Connecting the electrical supply wires to any other location will void the warranty.

TERMINAL BLOCK ASSEMBLY

The incoming electrical supply wires must be connected to the terminal blocks. Connecting the electrical supply wires to any other location will void the warranty.



6.9 Push Button Membrane

The buttons and lights on the front of the control panel are made into a plastic membrane that is sandwiched between the plastic overlay and the sheet metal face of the enclosure cover. Multiple “ribbon cables” attach to the buttons and lights. The ribbon cables fit through a slot in the sheet metal door on the control panel and the cables pug into the Membrane Encoder (see section 6.1b) to allow the buttons to signal the UPM for the Start, Stop and Unload functions. The large connector ribbon cable allows the UPM to illuminate the lights on the membrane. The membrane and overlay are bonded to the sheet metal with an adhesive. If the membrane malfunctions, the overlay and the membrane will both have to be replaced. The adhesive is strong enough that the membrane and overlay cannot be removed without damage to both components. The following illustrations show how to check the operation of the push buttons.

Disconnect the large and middle size ribbon connectors and apply the leads of an ohm meter to the middle size connector as shown. If the ohm meter does not show continuity when the button is pressed and a break in continuity when the button is released then the membrane must be replaced.

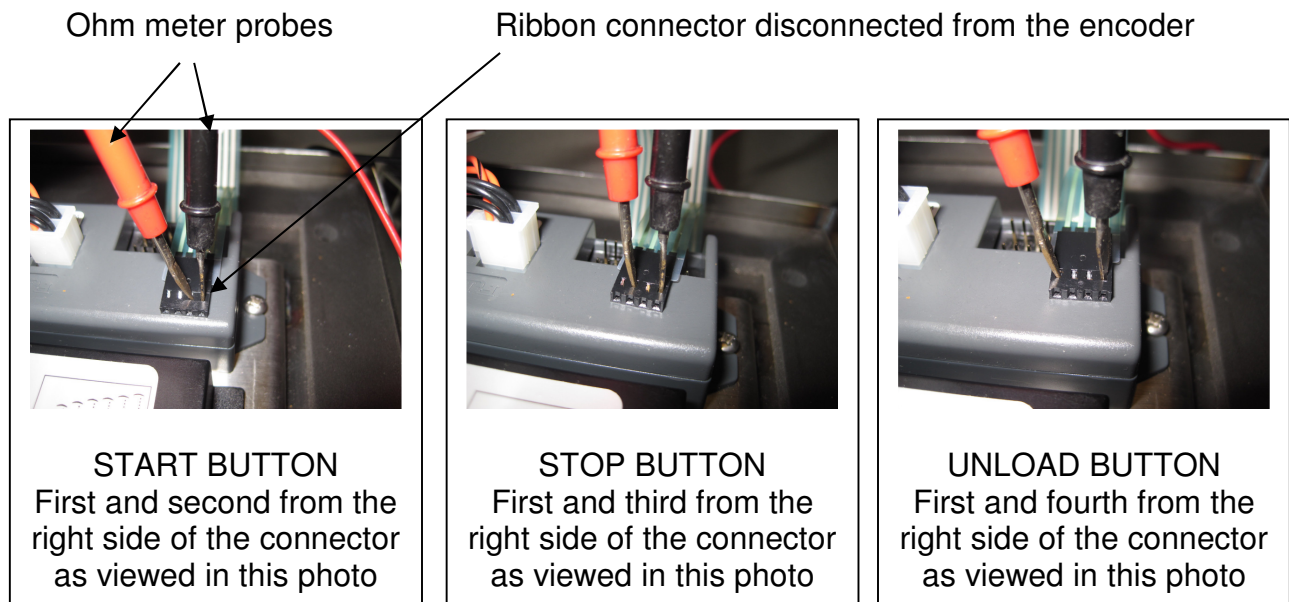

The large connector is unplugged to allow access to the middle size connector. The large connector carries the signals to all the lights in the membrane except the POWER light. The small connector carries the 24VAC to the POWER light. The small connector is plugged into the wire harness, which is not part of the Membrane Encoder. Orientation of the small connector to the wiring harness connector is not important.

Power Soak[®]

Electrical Components - Section 7 Authorized Personnel Only

PS-275

AUTHORIZED SERVICE AGENCY

This section contains procedures that are to be performed only by authorized service personnel. DO NOT attempt to do these procedures without proper training. To obtain information for a recommended service agent, please call the Power Soak Service Department at 1-800-444-9624.



7.1 Pump Motor

The pump motor is bolted to a mounting plate that is attached to the pump housing. The pump impeller is attached directly to the motor shaft. A rotary joint seal is used to separate the water containment area from the front of the motor (see section 8.1 for assembly instructions). The pump impeller and motor must rotate smoothly without “dragging” anywhere in the rotation. The motor shaft can be turned by hand to verify that the motor is rotating properly and that the pump is not jammed with debris. To rotate the motor by hand, turn off the electrical power to the machine at the circuit breaker before working on the pump motor. Remove the fan cover and turn the fan blade by hand. If the fan blade will not rotate easily and/or smoothly there is a problem with the motor or the pump. The motor will have to be removed from the pump housing to determine the source of the problem (see section 8.1). Install the fan cover before turning on the power to the machine.

The Pump Motor fan cover provides protection from the moving fan blade. The power to the machine must be turned off at the circuit breaker in the wall mounted enclosure when working on the pump motor. Failure to turn off the power will result in serious injury.



The Pump Motor is connected to high voltage electricity. The power to the machine must be turned off at the circuit breaker in the wall mounted enclosure when working on the electrical connection for the pump motor. Failure to turn off the power will result in serious injury and possibly death.



7.2 Motor Thermo-disc

The Motor Thermo-disc is a protection device to keep the motor from being damaged by excessive heat. If the temperature at the Thermo-disc reaches 180°F, the disc opens, turning off power to the UPM. To check the operation, first shut off the circuit breaker in the wall mounted enclosure that supplies electrical power to the control panel. Open the control panel enclosure and locate the two wires extending out of the conduit fitting that is connected to the motor. Unplug the connectors that are attached to the yellow wires from the wiring harness (on the schematic these are shown as P9 and J10 connected to J9 and P10 for the Motor Thermo-disc). Use an Ohm meter to check the resistance across the two wires that are attached to the motor thermo-disc (wires

extending out of conduit fitting). The device should read less than one ohm when closed. Check each wire for a “short” between the wire and the system ground connection. A “short to ground” from either side of the Thermo-disc indicates that the Thermo-disc is defective. These conditions will keep the UPM from operating correctly. On some motors, the Thermo-disc is built in to the motor, which is not replaceable. On other motor styles, it is located in the wiring box of the Motor, which is replaceable. When replacing the Thermo-disc, it is imperative to put heat sink compound on the side of the Thermo-disc that will be against the motor to ensure good heat transfer. (NOTE: The heating element thermo-disc is wired in series with the motor thermo-disc, see the schematic for wiring information.)

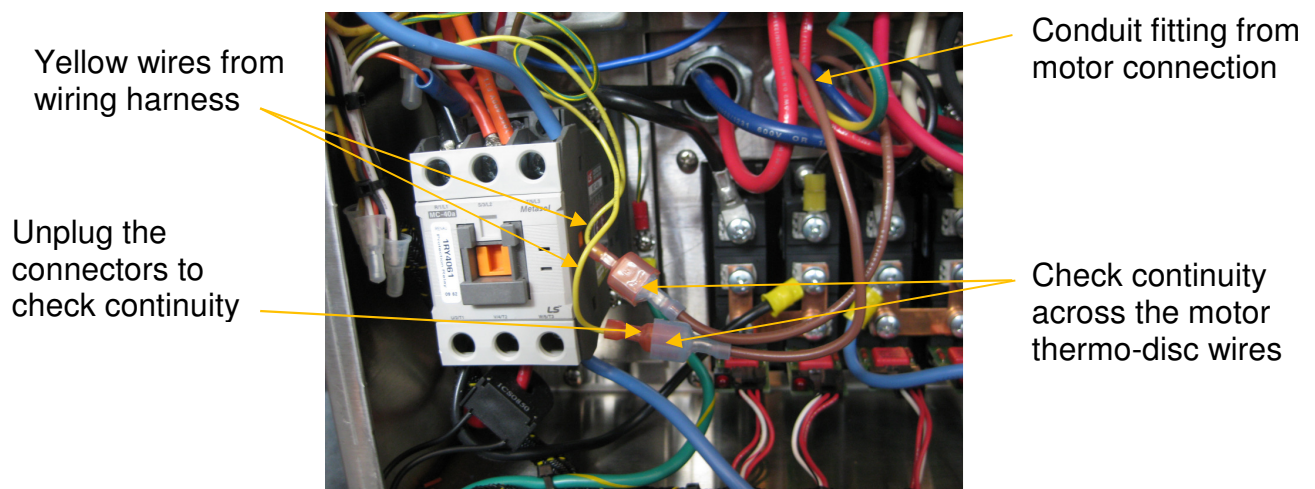

7.3 Heating Element

Most Power Soak pot washing machines are built with the heating element option. The heating element is located under the removable plate in the slanted surface of the back wall of the wash tank. The heating element will only operate if the wash tank is full and the pump motor is running. The element will cycle on and off as necessary to keep the wash solution at the preset operating temperature. The operating temperature is adjustable with a setting in the UPM. The temperature setting is described in the UPM programming manual number 37193.

Heating elements have been made in a variety of styles that have different appearance but all work the same. Each of the different styles use the same mounting flange and are interchangeable for the same performance in heating the fluid in the wash tank.

There are three heating coils within one element and each heating coil has two wires to connect the coil to the electrical circuit. The wires for a single coil are directly across from each other on the longest dimension of the mounting plate.



ROUND ROD STYLE HEATING ELEMENT



FLAT BAR STYLE HEATING ELEMENT
(Note: flat bar style has three elements inside the flat bar)

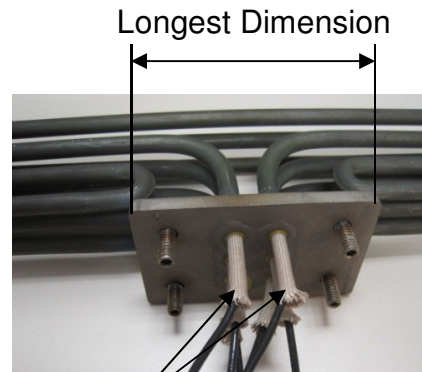

These two wires are part of the same heating coil on both the round rod style and the flat bar style.

The heating element in a Power Soak sink is rated at 7000 watts. Electrically, the Heater is considered as three separate elements, each rated at 2333 watts. To check operation of the heat element, first turn the power off at the circuit breaker located in the enclosure on the wall. Disconnect the H2 wire from terminal H2 and the H1 wire from the triac H1 terminal (and H3 wire from H3 triac, if 3 phase) in the Control Panel. Use an Ohm Meter to check between each heater lead and the control panel ground to be sure there is not a connection. Check the resistance between each of the combinations of heater wires listed on the chart. The heater should be within approximately 10% of the resistance value shown on the chart. The voltage and phase information is imprinted on a surface of the heating element mounting flange. See section 8.2 of this manual for instructions on removal of the heating element.

<u>Connection</u>	<u>Heater Rated Voltage</u>	<u>phase</u>	<u>Resistance (ohms)</u>
H1-H2	208-230	1	7.56
H1-H2	208-230	3	15.12
H2-H3	208-230	3	15.12
H1-H3	208-230	3	15.12
H1-H2	460	1	32.91
H1-H2	460	3	65.83
H2-H3	460	3	65.83
H1-H3	460	3	65.83

If the reading varies significantly from the chart above, the heater may be defective, or there may be a broken wire or loose connection

7.4 Heating Element Thermo-disc

The Heater Thermo-disc is a device used to detect a high temperature created by the heating element. If the temperature at the Thermo-disc reaches 135°F, the disc opens, turning off power to the UPM. The Thermo-disc is located close to the Heater, inside the Sensor Pad (see section 8.3 for Sensor Pad) or on the mounting flange of the heating element. To check the operation of the thermo-disc, turn off the circuit breaker in the wall mounted enclosure that supplies electrical power to the control panel. Unplug the spade connectors for the motor thermo-disc (see section 7.2) and locate the yellow wire with the male spade connector. Locate the connection to the transformer wires that has a grey wire from the wiring harness and remove the grey wire from the connection. Use an Ohm meter to measure the resistance across the male spade connector and the grey wire. If this measurement shows more than one ohm of resistance it will keep the UPM from operating correctly. Individually check the male spade connection and grey wire for continuity to the machine ground. Continuity to the ground would indicate a defective thermo-disc that will need to be replaced. Reconnect the wires after the evaluation is completed. (NOTE: The motor thermo-disc is wired in series with the heating element thermo-disc, see the schematic for wiring information)

7.5 Thermistor

The Thermistor is a temperature sensor located close to the Heater, inside the Sensor Pad that is mounted to the outside of the wash tank (see section 8.3 for location). The UPM measures the resistance through the Thermistor, and associates that resistance to a temperature. The temperature measurement is used to turn the heating element on and off for controlling the wash solution temperature. To check the Thermistor, unplug the white connector from the UPM and using an Ohm meter measure the resistance across the violet colored wires connected to pin 8 and pin 9 of the cable connector (refer to section 6.0 for pin layout). The UPM will signal an error if it reads a resistance greater than 430 k and less than 15 k. Replace the Thermistor if the reading indicates that it is defective.

7.6 Liquid Level Sensors

There are two Liquid Level Sensors in the side wall of the wash tank, and two in the side wall of the sanitize tank (if equipped with a sanitize tank). The sensor located at the bottom of the tank is used to detect when the tank has been drained and the sensor at the top of the tank is used to determine when the tank is full. To check operation, unplug the white connector from the UPM. Measure the resistance between the face of the liquid level sensor and the appropriate pin of the white connector (see section 6.0 in this manual). If the reading is greater than one ohm, clean the face of the sensor, inspect the wiring connections or replace the sensor. A reading greater than one ohm may be caused by a dirty sensor, a broken wire, or a loose connection. The loose connection may be at the sensor connection to the wiring harness or the wiring harness connector may not be tight at the back of the Control Panel.

<u>Description</u>	<u>UPM pin number</u>	<u>Wire Color</u>
Wash Tank Low (W-L)	Pin 20	White with Orange stripe
Wash Tank High (W-H)	Pin 21	White with Green stripe
Sanitize Tank Low (S-L)	Pin 22	White with Yellow stripe
Sanitize Tank High (S-H)	Pin 23	White with Blue stripe



Power Soak®

Assembly Procedures - Section 8 Authorized Personnel Only

PS-275

AUTHORIZED SERVICE AGENCY

This section contains procedures that are to be performed only by authorized service personnel. DO NOT attempt to do these procedures without proper training. To obtain information for a recommended service agent, please call the Power Soak Service Department at 1-800-444-9624.



8.1 Motor and Pump

8.1a Disassembly – Turn off the electrical power to the machine at the circuit breaker in the wall mounted enclosure and drain the wash tank. To service the pump or motor the wash tank must be empty. Refer to the illustration in Section 10.1 for the following description: Remove the Nuts (15) holding the Adapter Plate (13) with a 9/16 wrench, and then slide the adapter plate and motor assembly off the studs. **NOTE: This assembly will weigh approximately 45 pounds and must be supported so that it does not drop on the floor when it is removed.** Use a 9/16 socket and ratchet to unscrew the bolt (4) from the center of the pump Impeller (6). Slide the impeller and components off the motor shaft. Mark the orientation of the adapter plate to the motor and unbolt the Motor (16) from the Adapter plate using a 5/16 Allen wrench to remove four Bolts (12). Push the seal base for the mechanical seal out of the Adapter Plate from the motor side (seal base exits on the pump rotor side of the plate). Push the Shaft Sleeve (9) out of the Mechanical Seal and remove the Sleeve O-Ring (8) from the end of the shaft sleeve (it may be stuck to the face of the impeller shaft instead of in the shaft sleeve seal groove).

8.1b Inspection - Inspect the components for damage or signs of wear. Examine the Adapter O-Ring (11) and the Sleeve O-Ring (8) to see that they do not have nicks, cuts or flat spots. Both faces of the Mechanical Seal must be smooth and free of nicks or scratches. The motor shaft must spin by hand with a smooth rotation and no rubbing noise. Replace components if they are defective. The pump impeller must not have cracks or deep grooves in the fins or support structure.

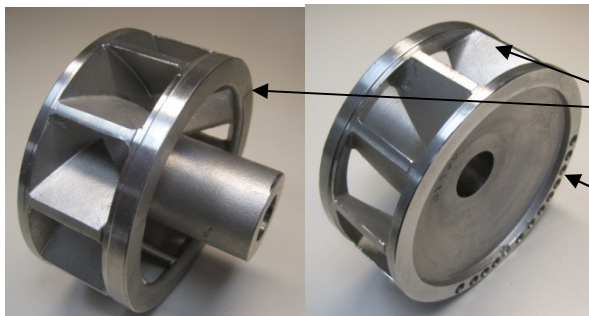

Impeller blades and support structure are free of grooves and cracks

Holes are drilled by the manufacturer for balancing the impeller

NEW IMPELLER

Impeller blades have been damaged by foreign object entering the suction manifold and lodging in the pump housing.

Note: When purchasing a new impeller, the number of vanes and the direction of rotation (left hand or right hand sink configuration) are critical to receiving the correct part. Contact the Power Soak field service department for help.

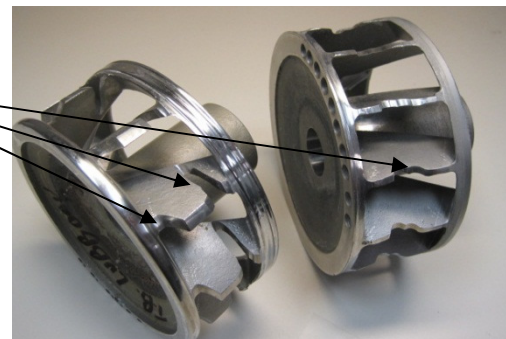

DAMAGED IMPELLERS

8.1c Assembly – Refer to the illustration in Section 10.1 for the following description: Apply a thin coating of light weight oil such as WD-40 to the outer surface of the Mechanical Seal base (10) and push the base into the Adapter Plate (13) with the white surface of the base oriented to the pump side. Apply a thin coating of light weight oil to the interior of the Mechanical Seal (10) and slide the seal onto the Shaft Sleeve (9) with the protruding ceramic face of the seal oriented away from the shoulder on the sleeve.

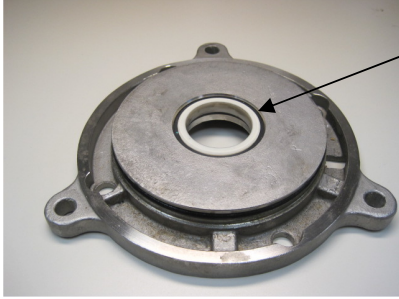

The mechanical seal base is installed into the adapter plate with the ceramic (white) face oriented toward the pump side of the plate

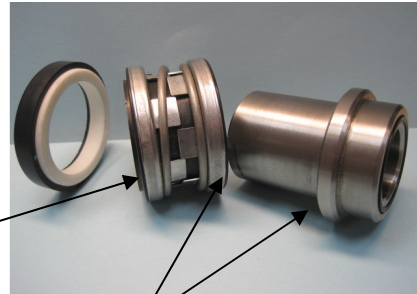

The protruding ceramic face of the mechanical seal is to be oriented to contact the white face of the mechanical seal base.

The shaft sleeve will slide through the mechanical seal oriented so that these two faces make contact with each other

Place the adapter plate on the face of the motor with a drain slot aligned with the connection box and the other drain slot oriented as shown for the configuration of the machine. This will allow the connection box to be on the bottom side of the motor when the pump and motor are assembled onto the volute pump housing. Install the bolts with a 5/16 Allen wrench.

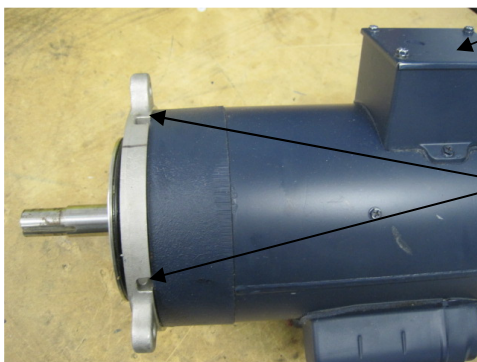

Connection box

Drain slot alignment

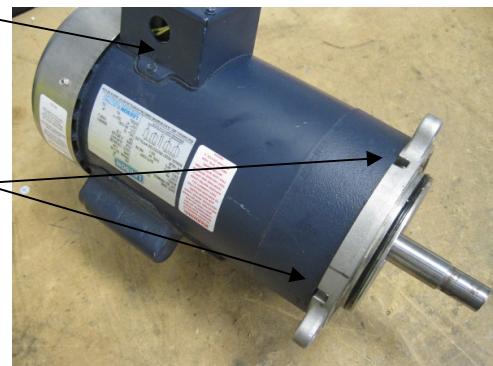

Flange orientation on units that are made for Left to Right work flow.
(Sanitize tank on right side of wash tank)

Flange orientation on units that are made for Right to Left work flow.
(Sanitize tank on left side of wash tank)

Wipe the faces of the mechanical seal parts so that they are free of debris and slide the shaft sleeve assembly onto the motor shaft so that the protruding ceramic face of the mechanical seal makes contact with the white face of the seal base. Place the Shaft Seal (8) into the groove on the end of the Shaft Sleeve (9). Insert the Impeller Key (7) into the motor shaft with the flat side of the key oriented toward the bottom of the motor keyway. The rounded side of the key will fit into the rounded groove in the impeller. Orient the keyway in the Impeller (6) to align with the motor key way and slide the impeller onto the motor shaft. Secure the impeller to the shaft with the Impeller Bolt (4), tighten it to approximately 23 ft-lb of torque. Inspect all the mating faces in the shaft assembly to be sure that the seals have not slipped out of position. Smear a thin coating of food grease on the O-Ring (11) and place it in the groove on the outer diameter of the Adapter Plate (13). Slide the ears of the adapter plate over the studs on the Volute pump housing (1) and secure the plate with the Washers (14) and Nuts (15). Tighten the nuts to approximately 23 in-lb of torque. Remove the motor fan cover and spin the motor by hand to determine that the pump impeller is not rubbing on anything. Install the motor fan cover to prevent contact with the fan during operation.

8.2 Heating Element

8.2a Disassembly - Drain the wash tank and turn off the electrical power at the circuit breaker in the wall mounted electrical enclosure. Remove the cover from the outside bottom surface of the wash tank and note how the existing Heater is wired (it is helpful to take a picture or make a sketch of the wire connections). Unbolt the cover plate inside the wash tank on the slanted surface of the back wall. Remove the nuts from the heater element mounting plate on the bottom side of the wash tank and unplug the electrical wires from the terminal block. Lift the element out through the opening in the back wall of the wash tank and remove the gasket from the mounting plate of the element.

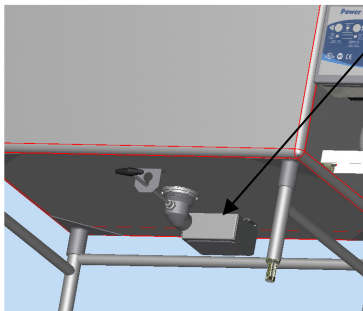

Remove the cover on the bottom side of the tank to access the heating element mounting bolts and wiring.

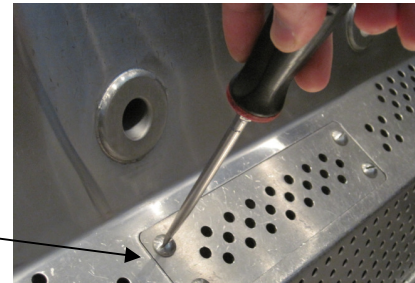

Remove the cover inside the tank to access the heating element.

8.2b Inspection – Examine the gasket for cracks or tears. Examine the wires extending out of the base of the element. The insulation on the wires must not be burned, cracked or missing. The connectors on the end of the wire must be free of corrosion, crimped tight on the wire and no broken wires. Clean debris off the heating element coils and inspect the coils for cracks or burned areas on the surface of the coil. Replace any defective part with a new part.

8.2c Assembly – Place the gasket on the bottom surface of the heating element mounting plate. Insert the heating element through the opening in the back wall of the wash tank. Push the wires through the center opening and align the studs with the mounting holes on the bottom surface of the tank. Install the nuts on outside surface of the tank to secure the heating element to the bottom of the tank. Tighten the nuts to pull the mounting base snug against the bottom surface of the tank and then turn the nut another ½ turn to secure the element. Fill the tank with a few inches of water and check for leaks around the heating element mounting holes. Connect the heater wires to the terminal block. Machines that have three power supply wires (L1, L2, L3) attached to the terminal block will use the three phase connection and machines that only have two power supply wires (L1, L2) attached to the terminal block will use the single phase connection.

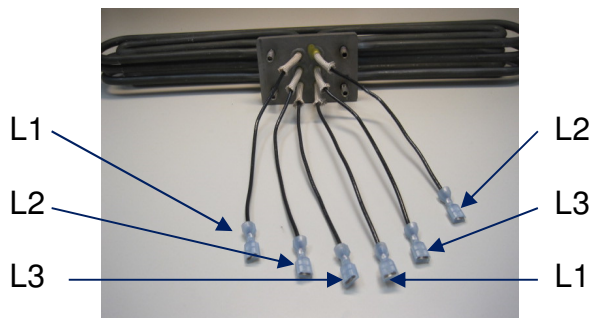

WIRING CONNECTION FOR 3 PHASE HEATING ELEMENT

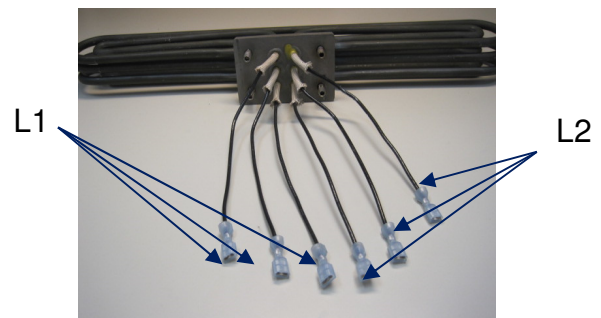

WIRING CONNECTION FOR SINGLE PHASE HEATING ELEMENT

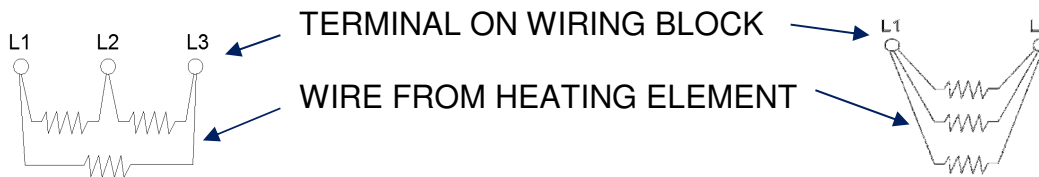

Install the cover over the heater access opening inside the wash tank. Be sure that the cover is seated well with no gaps around the edges that will allow debris to enter the pump suction manifold. Start a wash cycle and check the operating temperature of the water. The water should heat to approximately 115°F within two hours.

The heating element access cover must be installed while the pump is operating. Failure to install the heating element access cover will allow objects to enter the pump suction and damage the pump impeller.



8.3 Sensor Pad

8.3a Disassembly - To access the contents of the Sensor Pad, unbolt the mounting bracket that holds the sensor pad and remove the sensor pad from the back side of the wash tank. Lift the retainer plate out of the rubber pad and then remove the electrical components.

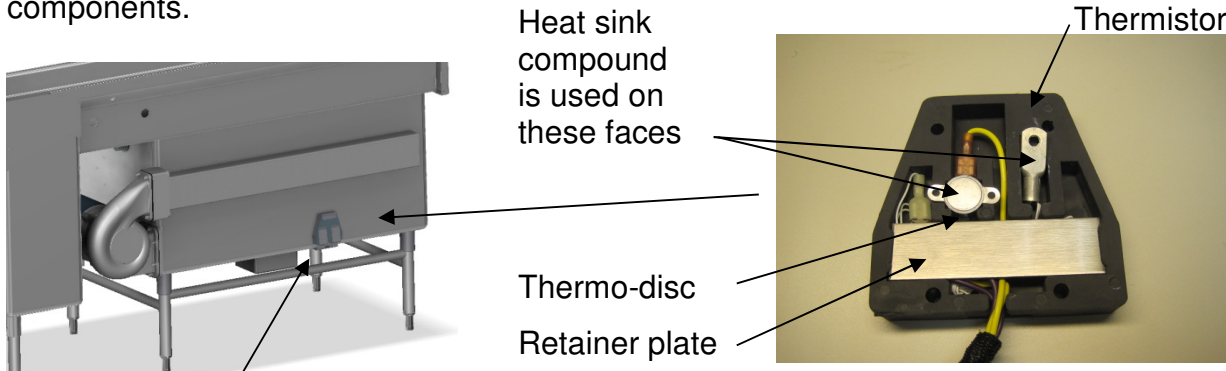

The sensor pad is located on the back side of the wash tank

Sensor pad removed from wash tank.

8.3b Inspection – Examine the wires for damage to the insulation. Test each of the components for proper function. Unplug the spade connectors from the tabs on the thermo-disc and use an Ohm meter to measure the resistance across the tabs of the thermo-disc. If this measurement shows more than one ohm of resistance it will keep the UPM from operating correctly. Individually check each tab connection for continuity to the mounting flange. Continuity to the flange would indicate a defective thermo-disc that will need to be replaced. Check the operation of the Thermistor as described in section 7.5.

8.3c Assembly – Place the components back into the rubber pad and secure them in place with the retainer plate. It is very important to use heat sink compound on the side of the thermo-disc and thermistor that will be placed against the surface of the tank to ensure good heat transfer. Slide the pad assembly back into the mounting bracket and bolt the bracket to the side of the wash tank.

8.4 Chemical Dispenser (Optional)

A chemical dispenser can be purchased from Power Soak. The dispenser that is purchased from Power Soak will be mounted under the drain board on the “clean side” of the sink assembly and contain two or three pumps, depending on the application. The wiring harness has connections to supply power and operating signals to the chemical dispenser pumps. Malfunctions in the chemical dispenser can lower the operating voltage of the PS-275 to levels that are unacceptable and will cause problems with the operation of the PS-275 control system. See the chemical dispenser literature for more information on the operation and service of the dispenser.

Troubleshooting - Section 9

PS-275

AUTHORIZED SERVICE AGENCY

This section contains procedures that are to be performed only by authorized service personnel. DO NOT attempt to do these procedures without proper training. To obtain information for a recommended service agent, please call the Power Soak Service Department at 800-444-9624.



9.1 The pump will not start when the green “START” button is pushed.

9.1a. Control panel white POWER light is not on.

Possible Cause

1. The power supply to the machine is turned off.
2. The transformer has failed.

Solution

1. Restore power to the machine; check the circuit breaker in the wall mounted enclosure.
2. Check the transformer output (see section 6.5)

9.1b. Control panel white POWER light is on.

Possible Cause

The Wash Tank is empty.

Solution

Fill the wash tank with water and detergent according to the instructions in the operator’s manual.

9.1c. Control panel POWER (white) light is on, STATUS (green) light is on and WASH TANK (blue) light is on.

Possible Cause

The Wash Tank is empty or the wash solution life cycle has expired.

Solution

Fill the wash tank with water and detergent according to the instructions in the operator’s manual. If the wash tank is full, the life of the wash solution has expired; the tank must be drained and re-filled.

9.1d. Control panel POWER (white) light is on, STATUS (green) light is on and SANATIZER TANK (red) light is on.

Possible Cause

The Sanitize Tank is empty or the sanitize solution life cycle has expired.

Solution

Fill the sanitize tank with water and sanitize solution according to the instructions in the operator’s manual. If the sanitize tank is full, the life of the sanitize solution has expired; the tank must be drained and re-filled.

9.1d. Control panel STATUS light and ERROR are blinking with a pattern of long and short flashes.

Possible Cause

A problem has been detected by the program and the UPM is signaling an error code.

Solution

See section 5.5a to determine the error message.

9.1e. All of the lights on the control panel and all of the Alert Lights are flashing.

Possible Cause

The transformer output voltage is below an acceptable level.

Solution

1. Check the voltage on the transformer (see section 6.5).
2. Check the electrical connections to the transformer for correct connection to the power source and correct connection for 24V output.

9.2 Motor starts, but makes noise.

Possible Cause

1. Debris lodged in the pump housing.
2. The motor fan cover has been dented or has collected debris.
3. The motor is rotating in the wrong direction (only occurs when motor is first installed or replaced).

Solution

1. Turn the power off to the machine at the circuit breaker in the wall mounted electrical enclosure and remove the motor assembly (see sections 7.1 & 8.1). Be sure that the heater cover in the back wall of the wash tank is secure with no gaps around the edges that will allow foreign objects to enter the pump suction manifold (see section 8.2).
2. Turn off the power to the machine at the circuit breaker in the wall mounted electrical enclosure and remove the motor fan cover. Straighten the cover or replace it if the cover is damaged, clean the debris and install the cover back onto the motor.
3. Turn off the power to the machine at the circuit breaker in the wall mounted electrical enclosure and change the wiring connection for the motor (This must be done by a qualified electrician).

9.3 Motor starts, but no water flows in the wash tank.

Possible Cause

1. The key that drives the impeller has fallen out of the motor shaft keyway.
2. The pump impeller is broken or not connected to the motor shaft.
3. The motor is rotating the in the wrong direction (only occurs when motor is first installed or replaced).

Solution

- 1.& 2. Turn off the power to the machine at the circuit breaker in the wall mounted electrical enclosure and remove the motor assembly (see sections 7.1 & 8.1).
3. Turn off the power to the machine at the circuit breaker in the wall mounted electrical enclosure and change the wiring connection for the motor (This must be done by a certified electrician).

9.4 The control circuit fuse “blows” when the power is turned on.

Possible Cause

1. There is a short circuit in the chemical dispensing pump (not all machines have a chemical dispensing pump).
2. The coil in the contactor is drawing too much current.

Solution

1. Disconnect the cable on the back of the chemical dispenser and try a new fuse. If the fuse does not “blow” then have the chemical dispenser checked by a qualified service person.
2. Turn off the power to the machine at the circuit breaker in the wall mounted electrical enclosure and replace the contactor.

9.5 The lights indicate that the tank is empty when it is actually full.

Possible Cause

1. The sensor is coated with debris.
2. The wire connected to the sensor is loose or broken.
3. The control panel connector is loose

Solution

1. Clean the face of the sensor with a washcloth and soapy water.
2. Check the nut that secures the wire to the sensor on the outside of the tank.
3. Examine the control panel connector to see that it is properly connected.

9.6 The water gets too hot and stops the machine.

Possible Cause

1. Incorrect soap is creating too much foam. (Foam causes excess heat by reducing the efficiency of the pump and it insulates the top of the tank which holds in heat).
2. The Triac has failed and is passing current to the heater when it is turned off.

Solution

1. Change the wash solution and use a low foaming soap designed for continuous ware washing or reduce the quantity of low foaming soap that is added to the water.
2. With the machine operating, check the amperage on the heating element wires when the indicator light goes off. If the current does not go off when the indicator light is off, the Triac is defective.

9.7 The chemical dispenser pump runs, but does not pump the chemical.

Possible Cause

1. The hose has been punctured or ruptured.
2. The fitting has not been screwed onto the chemical container properly.

Solution

1. Replace the defective hose with a new hose.
2. Unscrew the fitting from the container; check the threads and face of the fittings for damage. Carefully screw the fitting back onto the container so that the fitting seats properly against the container opening.

If the trouble shooting procedures do not correct the problem, contact Power Soak Systems, Inc. at 800-444-9624 or an authorized service agency.

Power Soak®

Parts Lists – Section 10

PS-275



10.1 Motor and Pump Assembly

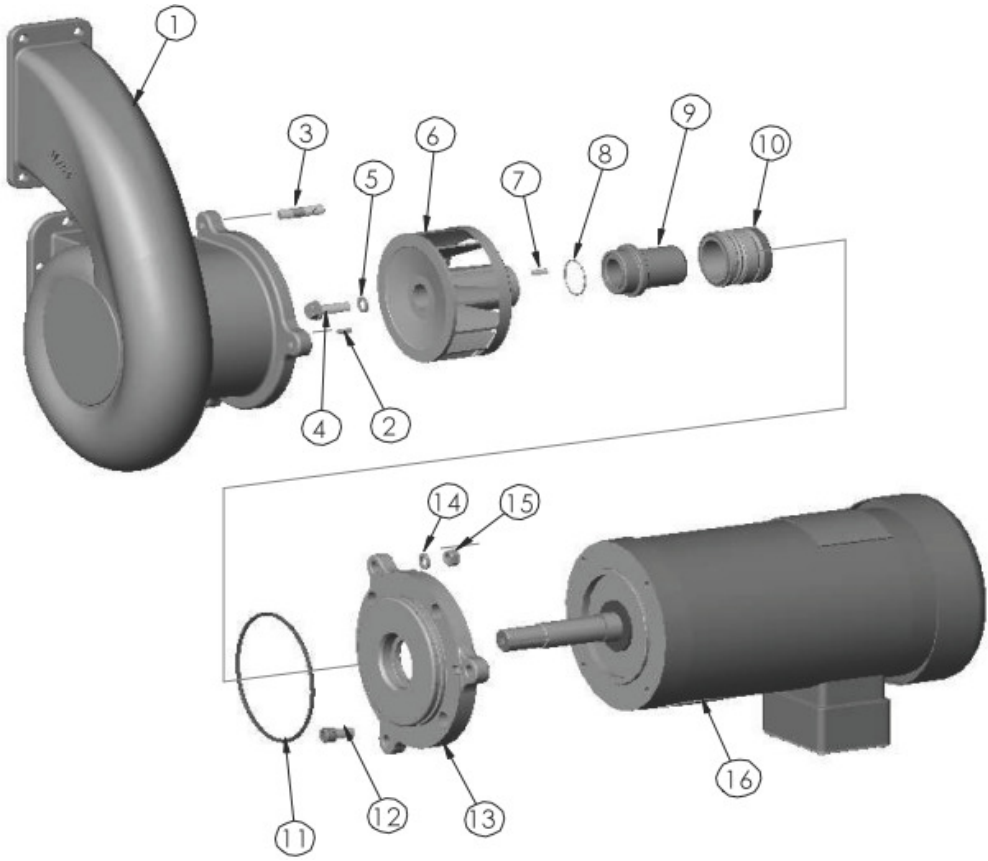

The part numbers for the Volute (1), Impeller (6) and Motor (16) are different for the different configurations of machines. Contact the Power Soak Service Department (1-800-444-9624) and provide the serial number of the machine for help with the part numbers.

10.1a Parts list

Item	Part Number	Description	Item	Part Number	Description
1	Varies	Volute	9	27481	Shaft Sleeve
2		Pin (part of volute)	10	27480	Mechanical Seal
3		Stud (part of volute)	11	27476	Adapter O-Ring
4	27478	Impeller Bolt	12	27483	Motor Bolt
5	27479	Impeller Washer	13	27525	Adapter Plate
6	Varies	Impeller	14	28312	Washer
7	27477	Impeller Key	15	28264	Nut
8	27475	Sleeve O-Ring	16	Varies	Motor

10.1b 60 Hz Motor and Impeller

HP	Side	Phase	Volt	Motor	Impeller
2.0	LH	1	208	29507	27592
2.0	RH	1	208	29507	27593
2.0	LH	1	230	29501	27592
2.0	RH	1	230	29501	27593
2.0	LH	3	208	29509	27592
2.0	RH	3	208	29509	27593
2.0	LH	3	230/460	29503	27592
2.0	RH	3	230/460	29503	27593
3.0	LH/RH	3	208	29510	27594
3.0	LH/RH	3	230/460	29504	27594

10.1c 50 Hz Motor and Impeller

HP	side	Phase	Volt	Motor	Impeller
2.0	LH/RH	1	220	29513	27594
2.0	LH/RH	3	380	29515	27594
3.0	LH	3	380	29516	27488
3.0	RH	3	380	29516	27489

10.1d Pump Parts Common to all Assemblies

Part #	Description
28920	Seal Kit
27886	Thermodisc-motor-thermal cutoff
27047	Volute Intake gasket
27132	Volute Discharge gasket
28262	Dowel Pin

10.1e Seal Kit

Part #	Description
28920	Seal Kit
Contents	
27480	Mechanical Seal
27475	"O" ring – sleeve
27476	"O" ring – seal plate
27478	Impeller Bolt
27479	Fiber Washer

10.2 Heater & Sensor Block

Part #	Description
29243	Heating Element – 208 volt
27930	Heating Element – 230 volt
29244	Heating Element – 380 volt
27939	Heating Element – 480 volt
27934	Heating Element Gasket
29654	Heating Element Cover
29642	Bolt – heating element cover
18797	Terminal Block – for heating element connection
27926	Thermistor – temperature sensor
28454	Thermodisc – heating element thermal cutoff
27322	Sensor pad
28928	Heatsink compound
29077	Retainer Plate

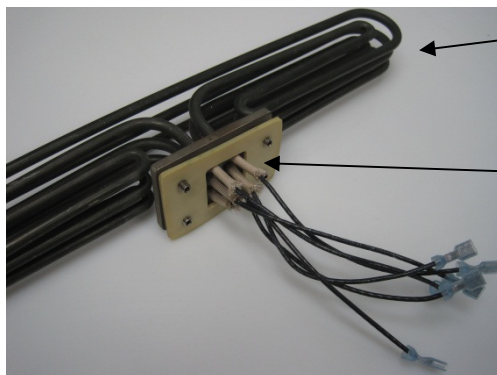

Heating Element

Heating Element Gasket

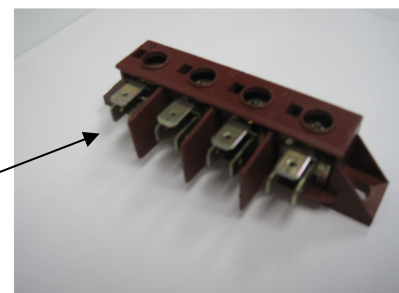

Terminal Block

Sensor Pad

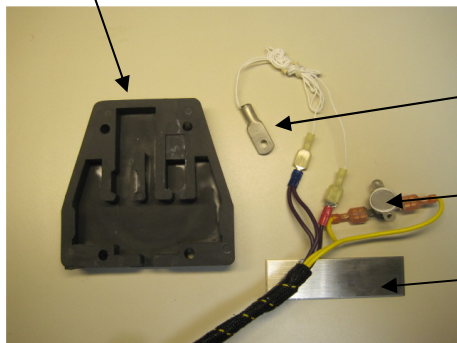

Thermistor

Thermodisc

Retainer Plate

10.3 Control Panel

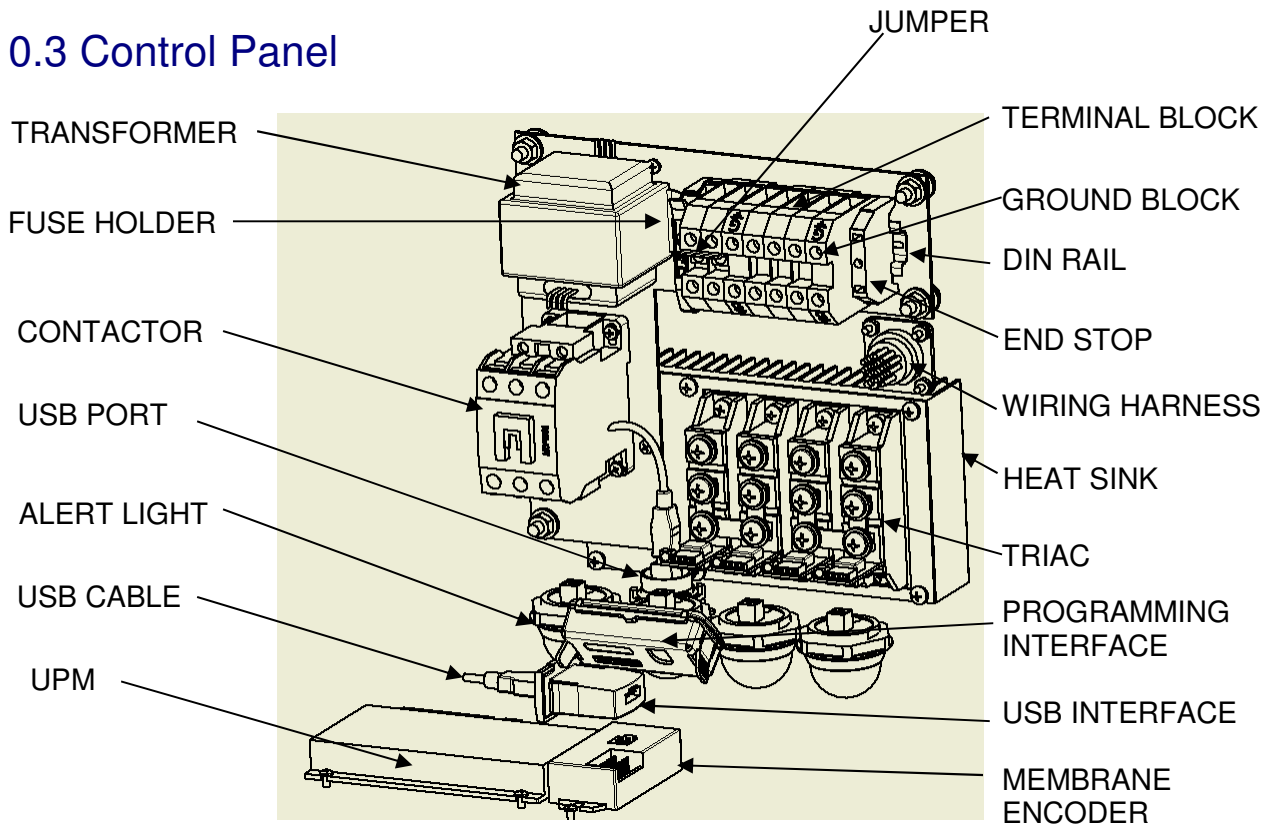

The control panel is shown without the sheet metal enclosure for clarity. Some variations of the control assembly do not contain all of the components shown.

Parts #	Description	Parts #	Description
33552	Contactor	29926	Jumper
27172	Transformer – 24 volt 208/230	33716	Alert Light - green
31659	Transformer – 24 volt 415/480	33715	Alert Light - red
36457	UPM – Programming Module	33536	Alert Light - blue
27923	Terminal Block	36206	Alert Light - orange
27924	Grounding Block	34823	USB Port
27925	Din Rail – mount for terminal blocks	34822	USB Cable
27928	Triac – solid state relay	34815	USB Interface
28923	Fuse Holder	34147	Programming Interface
27927	Heat Sink	33507	Overlay, L-R machines
32394	End Stop	33508	Overlay, R-L machines
33713	Wiring Harness – internal to control panel	29948	Power Filter – Use with 50 Hz only (not shown)
36209	Membrane Encoder	34824	Cover for USB Port (not shown)

10.4 Decal Locations and Part Numbers.

Some of the decals for a “left hand” unit will be different from a “right hand” unit. The information will be the same, only illustrated according to the direction of the work flow. The decals will also vary due to customer preferences; the part numbers for these decals may be obtained from the Power Soak service department (1-800- 444-9624).

10.4a Unit with Left to Right Work Flow

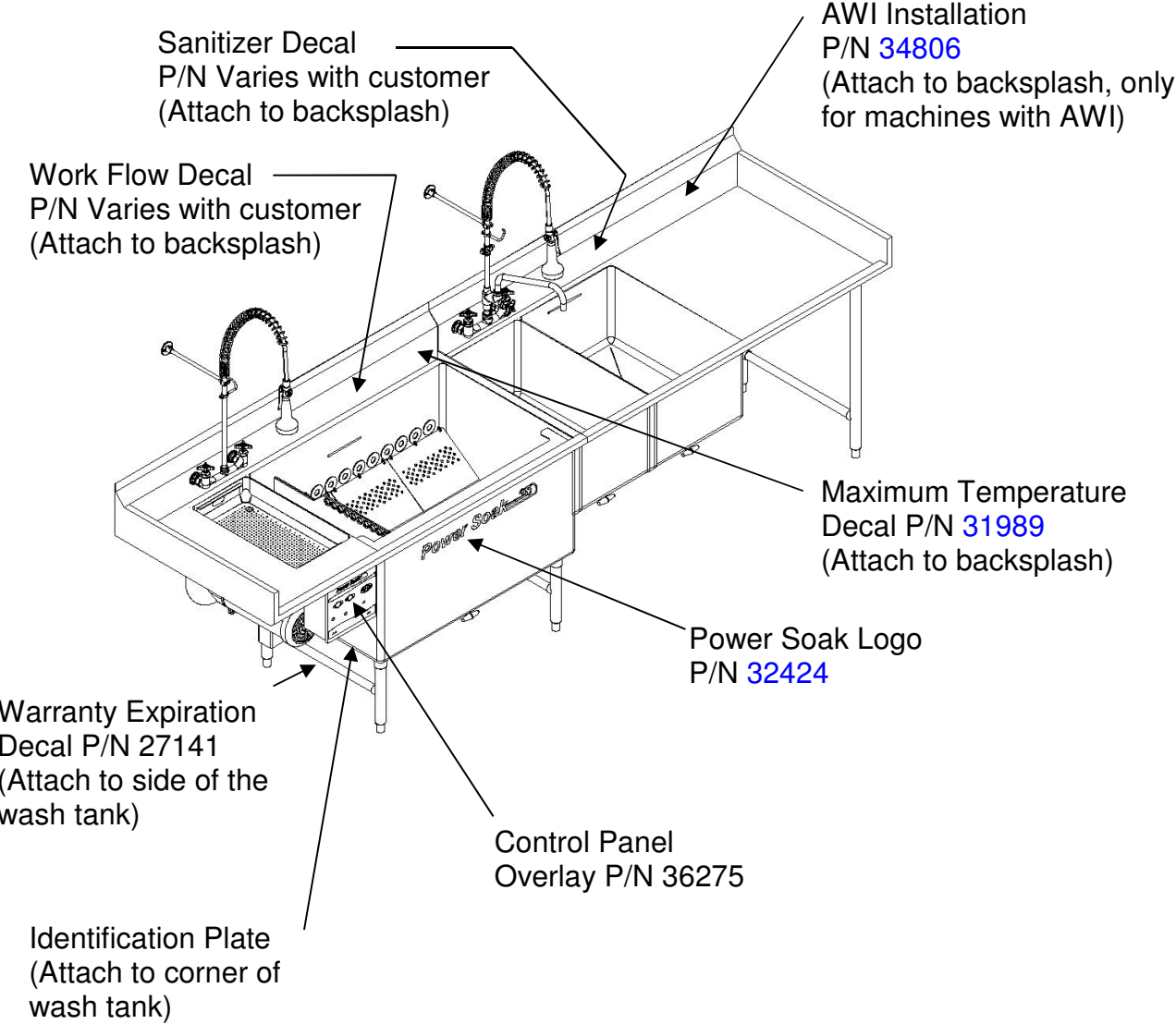

10.4b Unit with Right to Left Work Flow

AWI Installation
P/N 34806

(Attach to backsplash, only
for machines with AWI)

Sanitizer Decal
P/N Varies with customer
(Attach to backsplash)

Work Flow Decal
P/N Varies with customer
(Attach to backsplash)

Maximum Temperature
Decal P/N 31989
(Attach to backsplash)

Power Soak Logo
P/N 32424

Control Panel
Overlay P/N 36276

Warranty Expiration
Decal P/N 27141
(Attach to side of the
wash tank)

Identification Plate
(Attach to corner of
wash tank)

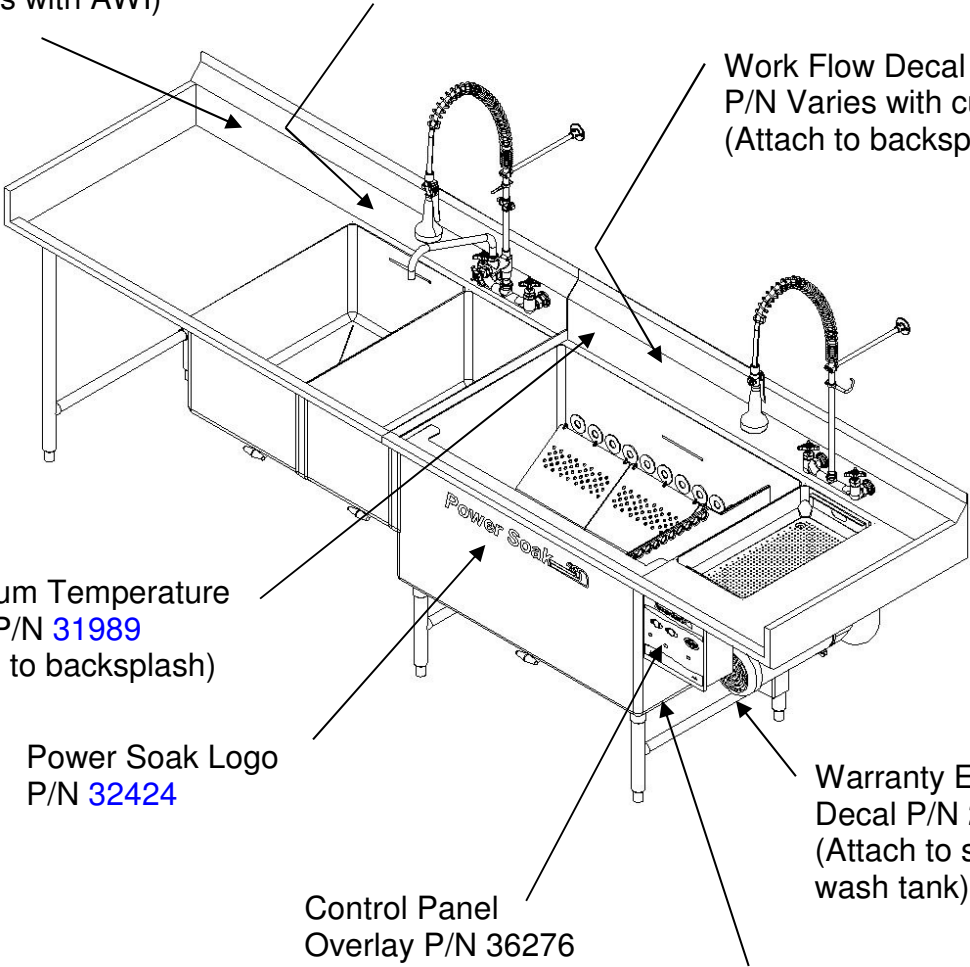

Appendix

PS-275

AUTHORIZED SERVICE AGENCY

This section contains procedures that are to be performed only by authorized service personnel. DO NOT attempt to do these procedures without proper training. To obtain information for a recommended service agent, please call the Power Soak Service Department at 800-444-9624.



Other PS-275 Manuals and Related Component Manuals

Description	Part Number
PS-275 Operators Manual	36212
PS-225 & PS-275 Installation Manual	34453
AWI (Advanced Wash Insert) Owner's Manual Supplement	33754
Wall Chart AWI Installation Instructions	34293
PS-275 UPM Programming Manual	37193
Soap Dispenser Installation Manual	27173

Wiring Diagrams

The following wiring diagrams are the two most common wiring methods for the PS-275. The wiring diagram for a machine that is constructed with a wiring configuration other than those shown can be obtained by contacting the Power Soak service department at 800-444-9624.



Advanced Wash Insert Installation Instructions



1 Place ribs along the back of empty and sanitized wash tank.
Coloque las varillas a lo largo de la parte posterior del tanque de lavado vacío y desinfectado.



2 Place ribs along the front of the tank.
Coloque las varillas a lo largo de la parte delantera del tanque.



3 Insert Flexible Tank Divider.
Introduzca el divisor flexible para el tanque.

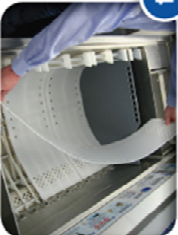

4 Rotate the plastic guide sheet after every installation.
Gire la hoja de guía de plástico después de cada instalación.

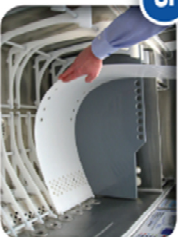

5 Insert a plastic guide sheet. Line it up along back of the tank.
Introduzca una hoja de guía de plástico. Alinee a lo largo de la parte posterior del tanque.



6 Line up plastic guide sheet along the front of the tank.
Alinee la hoja de guía de plástico a lo largo de la parte delantera del tanque.

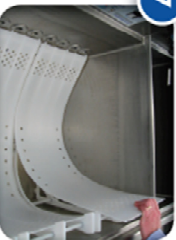

7 Insert the second large plastic guide sheet.
Introduzca la segunda hoja de guía de plástico grande.



8 Insert the small plastic guide sheet.
Introduzca la hoja de guía de plástico pequeño.



9 Place the Wave Guide as pictured on the front top of the Advanced Wash Insert.
Coloque el Conductor de Olas como se muestra en la parte delantera superior del inserto. Avanzado para el lavado.



You're done!
¡No está!

Daily Closing Cleaning Instructions



In empty tank, spray all parts with degreaser, scrub with green 'no scratch' pad.
En el tanque vacío, rocíe todas las piezas con desengrasante, frote con una almohadilla verde que no araña.



Rinse all parts with clean, warm water.
Enjuague todas las piezas con agua limpia y tibia.



Soak all parts in sanitizing solution for at least 1 minute.
Remoje todas las piezas en solución desinfectante durante por lo menos 1 minuto.



Place in tank and allow to air dry (DO NOT wipe off sanitizer.)
Colóquelos en el tanque y deje secar. (NO pise un paño para quitar el desinfectante).

Always inspect the Advanced Wash Insert for any broken pieces and notify the manager in charge immediately if observed.

Questions / Help Call Power Soak @ (816) 222-2400.

Patents Pending. Part No. 34293, Rev. 01 Feb. 2011



Power Soak is a registered trademark of Cantrell Industries, Inc.
The Power Soak Design and concept is fully patented.

Power Soak Systems. Inc.
903 East 104th Street, Suite 130
Kansas City, MO 64131
Phone (816) 222-2400 Fax (816) 222-2419
(800) 444-9624
www.powersoak.com

Part#: 37179
Rev: A
Rev Date: 12/19/13