



MX-220

Owner's Manual



Table of Contents

Product Introduction Page 3

Explanation of Warning Messages Page 4

- Danger
- Warning
- Chemical Hazard
- Personal Injury

Requirements for Detergents and Sanitizers Page 5

- Detergents
- Sanitizers
- Factory Assistance

Operating Instructions Pages 6-8

- Filling The System
- Rinse Water
- Sanitizer Water
- Adding Detergents and Sanitizers
- Manual Dispensing
- Auto Dispensing
- Wash Cycle

Controls & Features Pages 9-12

- Starting and Stopping the Wash Action
- Introducing Pots and Pans to the Power Soak
- Properly Scrapping Pots and Pans
- Loading and Using the Wash Sink
- Loading and Washing Utensils
- Unloading the Wash Sink
- Rinsing Pots & Pans
- Sanitizing Pots & Pans
- Drying of Pots & Pans
- Deep Cleaning and "Night Washing"
- Wash, Rinse and Sanitizer Clean-up



Table of Contents - Continued

Preventive Maintenance	Pages 13-14
Routine Preventive Maintenance	
Daily	
Monthly	
Notes	
Troubleshooting	Pages 15-18
Facility Owner/Manager Section	
Authorized Service Agency Section	
Component Operation & Checks	Pages 19-20
Parts List	Page 21
Electrical Schematic	Page 22
Pump and Motor Assembly	Pages 23-27
Installation	Pages 28-29
Electrical Requirements	
Providing Proper Electrical Service	
Plumbing Requirements	
Notes	



Product Introduction

Thank you for purchasing a *Power Soak* ware washing system.

Your new *Power Soak* pot, pan and utensil washing system will provide years of dependable, efficient and trouble-free service.

As a *Power Soak* owner, you will benefit in numerous ways:

- Your ware washing operation will be more efficient.
- Pots, pans and utensils will be cleaner.
- The overall level of sanitation in your scullery area will improve.
- Ware washing hours will decrease as employee morale increases.
- Chemical and water usage will decrease.

Every system is manufactured to last, with only high-quality, heavy-duty, 14 gauge stainless steel used in its construction. All electrical components used in a *Power Soak* system are of the highest quality. The faucets and drains are designed for quick filling and emptying of the system's sinks.

At Metcraft, we take pride in manufacturing the *Power Soak* line and are committed to standing behind our customers and products 100%. Should you ever need assistance, please contact us directly at the factory by dialing **800-444-9624** or fax: **816-761-0544**.

Explanation of Warning Messages

Be sure to read, understand and follow all DANGER, WARNING, and CAUTION messages located in this guide and on the equipment.

Danger

Personal Injury and Property Damage hazard.
May result in serious injury or death.
May cause extensive equipment damage

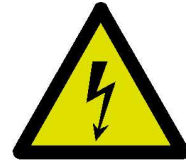

Warning

Property Damage Hazard.
May result in property or equipment damage.



Personal Injury Hazard

Hazard from sharp objects.
May result in serious injury or death.



Chemical Hazard

May result in serious injury or death. Instructions, labels and Material Safety Data Sheets (MSDSs) should be supplied with all detergents and sanitizing chemicals. The manufacturers, importers and distributors of your cleaning chemicals are responsible for providing this information.



Metcraft is not a chemical manufacturer, importer or distributor. Metcraft, Inc. can assist your chemical representative but will not make specific brand recommendations.

Requirements for Detergents and Sanitizers

Detergents

Remember, improper detergents may damage equipment! Use of the correct detergent in your *Power Soak* system is critical to its washing performance. If you are having problems with cleaning results, please contact the factory.

Your new system requires a low-foaming, metal/aluminum-safe detergent that is safe for the hands. The detergent should have good grease cutting abilities but not have an excessively high pH level.



Sanitizers

The method of sanitizing used in your *Power Soak* system is a "chemical sanitizing" method. There are a number of products on the market that work well. Your chemical sales representative should assist you in selecting the proper sanitizer for your application.

Check with your cleaning chemical provider to determine detergent concentration, sanitizer "parts per million" (ppm) and sanitizer submersion times to meet local health codes.

Factory Assistance

If your chemical sales representative is having difficulty selecting a detergent or sanitizer, or if you are getting poor results with the chemicals your representative has recommended, please contact the factory at **800-444-9624**.



MX-220

Operating Instructions



Preparing the System

Filling the System

At the beginning of each day or shift, fill the sinks with water that is metered to approximately the correct operating temperatures:

- Wash sink (115°F / 48°C)
- Rinse sink (75°F / 24°C)
- Sanitizer sink (75°F / 24°C)

All sinks should be filled to, but not above, the “waterline” marks.

Fill the wash sink (the sink with the water jets) with water that is approximately 115°F / 48°C. You can use the hot and cold taps on the faucet to adjust the water to the appropriate temperature. A good rule of thumb is that the water should be hot to the touch but not so hot that it is uncomfortable.

Rinse Water

If your method for rinsing wares is of the “submersion” type, fill the rinse sink (middle sink) with water that is approximately room temperature, 75°F / 24°C. There is no need to fill the rinse sink if your location uses a sprayer for rinsing wares.

Sanitizer Water

Fill the sanitizer sink (the last sink) with water that is approximately room temperature, 75°F / 24°C.

Your Chemical Company Should Be Aware of the Following:

The detergent must be low foaming, metal/aluminum-safe and not excessively caustic. Most standard sanitizers are acceptable.



Adding Detergents & Sanitizers

Manual Chemical Dispensing

After the sinks have been filled with water, add the proper amount of detergent and sanitizer. The detergent goes into the wash sink (the sink with the water jets) and the sanitizer goes into the sanitizer sink (the last sink).

Be sure to add the proper amount of chemicals to each sink. The amount to be used should be provided by your chemical supplier. Do not add the detergent or sanitizer to the sink prior to or during filling.

Automatic Chemical Dispensing

Your *Power Soak* may be equipped with an automatic chemical dispensing system. Be sure to follow the chemical company's instructions regarding the use and care of the dispenser.

Wash Cycle

Most detergents and sanitizers lose effectiveness as time goes on. Some local health departments have requirements limiting the amount of time water can be used for cleaning before the water should be changed. Most chemical companies recommend changing wash water after a certain time frame. Those times vary, but are generally around four hours. Check with your chemical provider.

Your *Power Soak* sink is equipped with a timer preset at four hours. This means that your *Power Soak* will turn off four hours after pressing the start button.

The following steps should be taken after the sink times out:

- Empty the wash sink
- Refill with fresh water
- Add your detergent
- Press the Start button

Check with your chemical provider on how often to replace your sanitizer.



Controls and Features

Start Button (green)

Starts the washing action and starts the timer. Your *Power Soak* sink will run continuously after this button is pressed.

Stop Button (red)

Stops the washing action and resets the timer.

Starting and stopping the wash action

To start the wash action, press the green “START” button. A strong “rolling” wash action should be present.

To stop the wash action, press the red “STOP” button.

Introducing Pots and Pans to the PowerSoak

Dirty pots and pans should be brought to the *Power Soak* in a timely manner. **Do not allow items to sit and air dry.** The quicker that items are brought to the *Power Soak* and put in the wash tank, the easier they are to clean!

Properly Scrapping Pots and Pans

Excess soils should be removed from the pots and pans prior to dropping them in the wash sink.

Deposit the excess soils into a garbage can.

Some systems may have an optional pre-scrapping area with a pre-rinse spray. If so, soils may be deposited into the scrapper sink.



Controls and Features - Continued

Loading and Using the Wash Sink

The *Power Soak* is a “random loading” system. This means that *Power Soak* items are not racked for washing. Instead, they are randomly loaded one at a time.

As items are brought to the system and scrapped, they should be immediately dropped into the wash sink.

If there is no movement of items in the wash sink, or if items are stationary above the waterline, the system has been overloaded and some items must be removed.

It is very important not to overload the wash sink, as it reduces the effectiveness of the wash action.

Some pots and pans stack for storage. This is referred to as “nesting” when it occurs during a *Power Soak* wash cycle. Make sure that nested items are separated and loaded one at a time. Nested items in the wash sink will not be properly washed.

Power Soak is a “continuous motion” system. This means that the system does not operate on a set cycle time like cabinet-type washing systems. Instead, during normal operating hours where washing is required, the system is (normally) left running. The *Power Soak* is energy efficient, and it does not cause excessive wear to leave it running continuously.

Typically, it takes between three to fifteen minutes to wash items. Some heavily soiled or burnt-on items may take longer to clean.

Loading and Washing Utensils

Each *Power Soak* system comes with a utensil basket that hangs in the wash sink. All utensils and other small wares should be loaded into and washed inside this basket.

Do not wash knives or other sharp objects in the Power Soak. Doing so may cause bodily injury.



Controls & Features - Continued

Unloading the Wash Sink

The employee responsible for pot washing should routinely pass by the *Power Soak* and remove clean items from the wash sink.

Items that are not 100% clean can be quickly finished off with a scrub pad or dropped back into the wash sink for additional cleaning.

Remember: it is not necessary to turn the wash action off to load or unload items from the wash sink. There are no moving parts within the wash sink that could cause bodily harm.

Rinsing Pots and Pans

Clean items that have been removed from the wash sink should be thoroughly rinsed. This is achieved by spraying them off or dipping them in the rinse sink (center).

It is important that any remaining detergent residue is removed from the items prior to sanitizing.

If items are rinsed by the "dipping" method, it is important to keep the water "fresh" by frequently draining and filling the rinse sink.

Sanitizing Pots & Pans

After items have been properly rinsed they must be sanitized in the sanitizing sink. (last).

It is necessary for each item to remain submersed in the sanitizing solution for a specific amount of time. The amount of time varies according to the type of sanitizer being used and local health codes.

Be sure to follow your chemical sales representative's instructions to ensure that all items are properly sanitized.

Drying of Pots & Pans

After items have been sanitized, they should be thoroughly dried on a clean drain board or on adjacent drying shelves.

Be sure to adhere to all local health codes and recommendations for proper drying and stacking of items.



Controls & Features - Continued

Deep Cleaning and "Night Washing"

Extremely soiled items and pieces of cooking equipment that require regular, intensive cleaning can be washed in the *Power Soak* system overnight.

Load the items to be deep cleaned into the Power Soak's wash sink, turn the system on and leave it running overnight. The *Power Soak* will run continuously until the morning crew arrives.

Items that have been cleaned overnight can be removed, rinsed, sanitized (if necessary) and put away or back in place.

Use your *Power Soak* as a "total cleaning system!" Remember, any item in your operation that can be submersed for cleaning and is not fragile can be washed without labor in your *PowerSoak*!

Here are some examples of items that are typically deep-cleaned overnight in the "Night Wash" cycle:

- Hood Filters
- Roasting Pans
- Stove Tops
- Frying Equipment

Many other items in your operation may qualify. Be creative and set up a regular "Night Wash" program for improved sanitation.

Wash, Rinse and Sanitizer Clean-Up

Between each water change and at the end of each night, all tanks and drain boards should be thoroughly cleaned with hot, soapy water.

It is also recommended to wipe down all the tanks and drain boards with a sanitizing agent. Ask your chemical provider to recommend a sanitizer for this application.

Preventive Maintenance

Your system requires minimal, routine preventive maintenance. As such, the following should be done on a routine basis to ensure that your system remains reliable:

Daily

Clean the liquid level sensors. These sensors are located on the side walls of the wash and sanitizer tanks. They are the white plastic discs with metal centers. Clean the sensor faces thoroughly. If cleaned regularly, a washcloth and soapy water are all that is required.

If the liquid level sensors are not cleaned regularly, the machine may fail to operate; or it may be possible to run it without water, which may cause serious damage to the unit.



Monthly

IMPORTANT: Turn off the power to the unit at the main breaker prior to performing the following task!

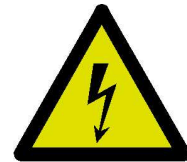

Clean the pump motor fan shroud with a damp, soapy rag. The motor shroud is the "vented" cover located at the end of the motor (closest to the control panel). This will prevent grease and dust from accumulating in the cover's openings, which can obstruct the airflow that cools the motor.

De-lime the wash sink. Simply add a de-liming agent to a sink of warm, fresh water and run the system overnight.

Ask your chemical sales representative to recommend a specific de-liming agent.

There are no other preventive maintenance procedures that you will need to perform on your *Power Soak* system. You need not be concerned about greasing the motor bearings, as they are permanently sealed. If you have any questions regarding the preventive maintenance procedures, please contact the factory at **800-444-9624**.



MX-220

Troubleshooting

Facility Owner/Manager Section

The only troubleshooting procedure that the facility owner or manager can perform is listed immediately below. All other procedures must be performed by an authorized service agency. To obtain the name of a recommended service agent in your area, please call the Metcraft, Inc. *Power Soak* Service Department at **800-444-9624**.

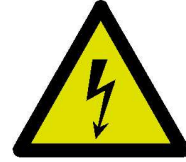

Pump does not work

Please perform the following in order:

- Drain the sink.
- Turn off the circuit breaker for your sink.
- Clean the liquid level sensor (LLS). This is located on the right or left inside wall (same side as control panel) of the wash sink, behind the removable baffle. The LLS is a white plastic disk with a silver metal center. Use warm soapy water.
- Fill the sink.
- Turn on the circuit breaker for your sink.
- Start the sink.

Authorized Service Agency Section

Hazard to untrained or unauthorized personnel.

The following procedures are provided for use only by an authorized service agency. No facility owner, manager, employee or other unauthorized person should attempt to perform any of these procedures. To obtain the name of a recommended service agent in your area, please call the Metcraft, Inc. *Power Soak* Service Department at **800-444-9624**.



When performing troubleshooting procedures, the authorized service agency will need to open the *Power Soak* system's main electrical enclosure.

Properly close the control panel before reconnecting the circuits.

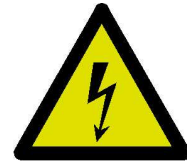

Refer to the previous checklist under the "Facility Owner / Manager Section" before proceeding to the following checklist items:



Pump leaks

Look For	Correction
1 PUMP CASING PLUG loose or defective	Tighten or replace
2 Defective PUMP SEAL	Replace



Authorized Service Agency Section

Pump does not work

Look For	Correction
1 No water in sink	Fill sink with water
2 LIQUID LEVEL SENSOR dirty	Clean LIQUID LEVEL SENSOR
3 No incoming power to unit	Reset customer's breaker in breaker control panel
4 Blown fuses	Replace blown fuse – Refer to wiring diagram for correct fuses
5 Loose wires	Tighten wires
6 LIQUID LEVEL CONTROL setting is too low	See page 20
7 Defective LIQUID LEVEL CONTROL or SOCKET	Check and replace as necessary
8 Tripped OVERLOAD	Push red RESET bar on OVERLOAD
9 Defective START or STOP switch	Check and replace as necessary
10 Defective CONTACTOR/OVERLOAD	Check and replace as necessary
11 Defective PUMP MOTOR	Check and replace as necessary

Overload trips

Look For	Correction
1 Low voltage to unit	Check with Volt meter while running
2 Improper Setting on Overload	Set on "10"
3 Debris in PUMP intake	Clean
4 Debris in IMPELLER	Remove PUMP and clean
5 Defective CONTACTOR	Check and replace as necessary
6 Defective OVERLOAD	Check and replace as necessary
7 Defective PUMP MOTOR	If amp draw is greater than 10% of motor rating and all of above check out, then replace MOTOR

Intermittent running

Look For	Correction
1 See 2, 5, 6, 7, 9, 10, 11 under Pump does not work	
2 Overload Tripping and Resetting	See "Overload Trips"
3 Sink not filled to "Water Line"	Make sure sink is filled to "Water Line". Soap foam does not count.

Component Operation and Checks

The following checks should only be performed by qualified technicians using extreme caution.

Electrical hazard to untrained personnel may result in electrical shock, burns, or death.

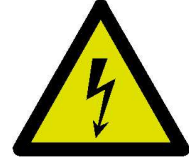

Pump Contactor

The thermal overload can be checked as follows:

1. If there is 208-230v across the coil (terminals A1 and A2) and the contactor does not pull in, the contactor is defective.
2. **TURN POWER OFF AT BREAKER PANEL.**
3. Remove the wires from terminals T1 and T3 on the thermal overload.
4. Push the contactor closed manually and check for continuity across pump contactor terminals L1 and T1, L2 and T2, L3 and T3. If no continuity on any of these, the contactor is defective.

Thermal Overload

The blue reset button should be in the down position (automatic reset). The dial should be set at 10. The trip indicator is located between the dial and the symbols "LR2".

The thermal overload can be checked as follows:

1. **TURN POWER OFF AT BREAKER PANEL.** Remove the wires from terminals 95 and 96.
2. Make sure the thermal overload is not tripped. If the thermal overload is tripped, reset it. If the thermal overload has tripped recently, you may have to wait several minutes for it to cool down before it will reset.
3. Check for continuity across terminals 95 and 96. If no continuity, the thermal overload is defective or the reset is tripped.
4. Make sure the T1, T2, and T3 terminals on the pump contactor are tight.
5. Remove the wires from terminal T1 and T3 on the thermal overload.
6. Check for continuity across T1 on the pump contactor and T1 on the overload, T2 on the pump contactor and T2 on the overload, T3 on the pump contactor and T3 on the overload. If no continuity on any of these, the overload is defective.



Component Operation and Checks

Push ON / Push OFF Start and Stop Buttons

TURN POWER OFF AT BREAKER PANEL. The stop button should have continuity at rest and no continuity when pushed in. The start button should have no continuity at rest and continuity when pushed in. Remove the wires before checking for continuity.

Liquid Level Control and Sensor

The liquid level control sends a trickle current (1/1000 amp) out terminal 5 to the liquid level sensor. If there is water in the wash sink, the current passes through it to the wash sink wall and back to the liquid level sensor to terminal 6. On some machines, the wire from terminal 6 is hooked up to a second probe instead of the wash sink wall. Reversing these 2 wires will not affect the operation. After the circuit is complete, a 10 second time delay is initiated. The purpose of this delay is to prevent rapid cycling of the relay should the water rise and fall below the sensor while the sink is filling. At the end of the time delay, the relay in the liquid level control will close sending current to operate the various components in the control panel. If the red "power" light on the timer is on, the liquid level control is ok.

On some models, the sensitivity of the liquid level control is adjustable. To adjust the sensitivity, clean the liquid level sensor, TURN POWER OFF AT BREAKER PANEL and check the resistance between the liquid level sensor and the wash sink wall (or second probe). It should be 25,000 to 35,000 ohms. If not, adjust the sensitivity as required. 25,000 to 35,000 ohms is generally between 0 and 1 on the dial. If there is no resistance, the wires from terminal 5 and 6 to the liquid level sensor and sink wall are loose, or the liquid level control or socket is defective.

If adjusting the sensitivity setting does not allow the machine to operate, the liquid level control can be checked as follows:

1. Set sensitivity as indicated above
2. Make sure wash sink is filled to the fill line. If the red "power" light on the timer is on, the liquid level control is ok. If the red "power" light is not on go to step 3.
3. Remove liquid level control from socket.
4. Check voltage across terminals 2 and 7 of the socket and 1 and 7 of the socket. It should be 208v-230v. If voltage is 208v-230v, go to step 5. If not, check the breaker, fuses, and wiring to the socket.
5. Note the location of terminal 3 on the socket.
6. Reinstall the liquid level control. Wait 10 seconds and check the voltage across terminal 3 on the socket and X2 on the transformer. If voltage is 208v-230v, the liquid level control is ok. If no voltage, the liquid level control or socket is defective.

Parts List

Pump Parts

29501	MOTOR-LEESON 2HP 230V
29507	MOTOR-LEESON 2HP 208V
26572	FAN-BALDOR MOTOR
29743	PUMP WITH MOTOR, IMPELLER AND CASING GASKET (W/B 2HP)
21356	FRAME ADAPTOR WITH WEAR RING
22446	SHAFT SLEEVE
25976	SNAP RING
21884	IMPELLER
25975	IMPELLER KEY
19345	GASKET-PUMP CASING (W)
24463	SEAL KIT-PUMP
RS1011	PUMP CLEANOUT PLUG

Control Panel Parts

103-052	SCREW-CONTROL PANEL (2)
23949	GASKET-CONTROL PANEL
23894	START SWITCH-PUSH BUTTON
23895	STOP SWITCH-PUSH BUTTON
23896	SWITCH BLOCK-STOP
23727	SWITCH BLOCK-START
29444	CONTACTOR
19885	LIQUID LEVEL CONTROL
21473	SOCKET, LIQUID LEVEL CONTROL
21472	HOLD DOWN CLIP, LIQUID LEVEL CONTROL (2)
23579	FUSE BLOCK, MAIN
23580	MOUNT-FUSE BLOCK
RS1471	GROUDING BLOCK
20281	FUSE BLOCK, CONTROL CIRCUIT
20642	FUSE 1 BUSSMAN LP-CC-20 (2)
20280	FUSE 3 BUSSMAN ABC 2
29939	OVERLOAD
27833	#10-24 THREADED STUD (6)
103-020	HEX NUT 1/4" X 20 (6)
103-014	NUT SERT #10-24 (2)

Miscellaneous Parts

23987	LIQUID LEVEL SENSOR
23988	GASKET - LIQUID LEVEL SENSOR
24853	INTAKE BAFFLE 28" (SERIAL #'S 1350 AND UP)
24860	INTAKE BAFFLE 25" (SERIAL #'S 1350 AND UP)
100-343	"O" RING - LEVER DRAIN

Electrical Schematic

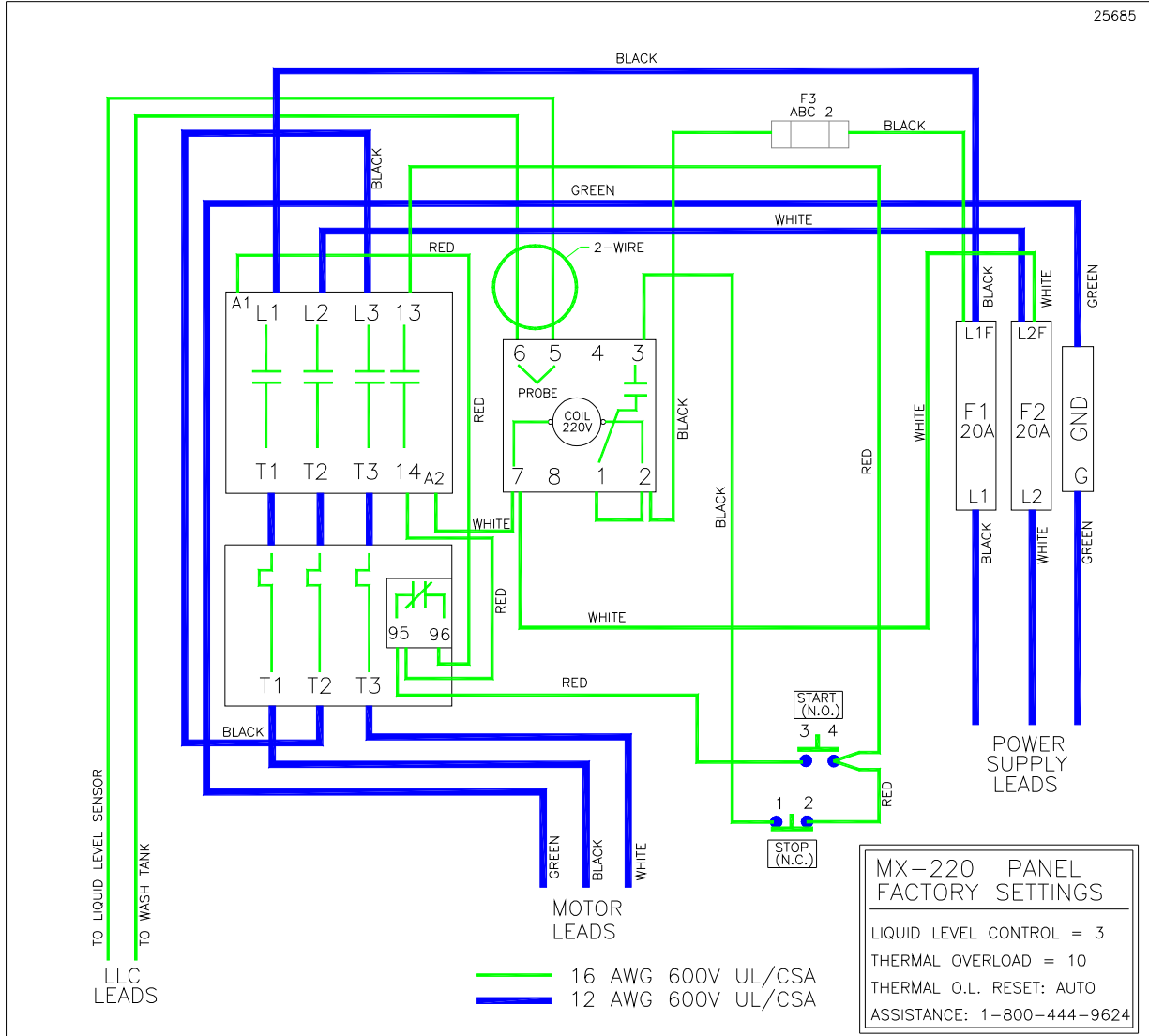

Motor and Pump Assembly

Exploded view

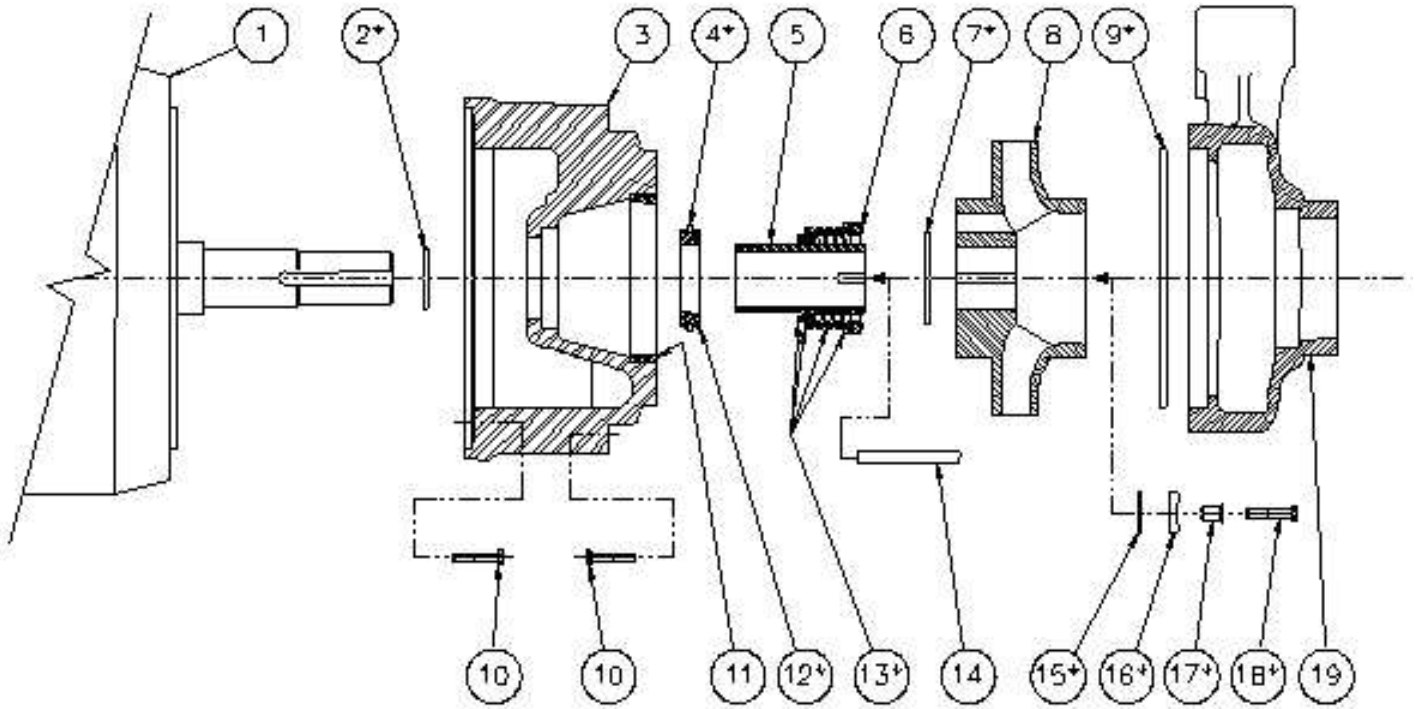

Item	Description
1	Motor, 2 HP, 50 Hz, 1 Ph, 230V
2 *	Sleeve O-ring
3	Black adapter with wear ring
4 *	Seat O-ring
5	Shaft sleeve
6	Retaining ring
7 *	Sleeve gasket
8	Impeller
9 *	Casing gasket
10	Screw

Item	Description
11	Adapter ring
12 *	Seal seat
13 *	Sleeve subassembly
14	Impeller key
15 *	Impeller washer gasket
16 *	Impeller washer
17 *	Impeller screw seal
18 *	Impeller screw
19	Casing

* indicates parts included in the seal kit



Motor and Pump Assembly Disassembly Procedure

1. Remove casing cap screws, which hold adapter to casing.
2. Pry adapter from casing with pry bar or large screwdriver and remove adapter and motor from casing.
3. Using a suitable holder to keep impeller from turning, remove impeller cap screw washer and gaskets. Be careful not to damage precision surfaces of impeller.
4. Remove impeller and impeller key from shaft.
5. With impeller and key removed, the shaft sleeve and the mechanical seal assembly can be removed as a unit. Sometimes, the sleeve is difficult to remove due to rust from moisture accumulation. If this is the case, applying heat to the sleeve exterior with a torch and/or a gear puller may help. The heat allows the sleeve to expand. However, too much heat may allow the shaft to expand as well.
6. Remove adapter cap screws, which hold adapter to motor.
7. Remove adapter from motor by prying with pry bar or screwdriver.
8. With adapter removed, the seal and seat ring can be pushed out with the fingers.



Motor and Pump Assembly Inspection and Repair of Components

With pump wet end disassembled, clean all parts and check for worn or damaged areas. It is seldom economical on these pumps to repair damaged or worn parts. Therefore, when a part is found unusable, it should be replaced.

Casing

Clean and inspect gasket surfaces for damaged areas that would cause leaks. Check wearing ring surfaces for excessive wear.

Impeller

Check wearing ring surfaces for excess wear and gasket surfaces of impeller hub for damage. If excessively worn or eroded, the impeller should be replaced.

Adapter

Clean and inspect gasket surfaces. Remove any dirt or scale from mechanical seal cavity. Check adapter ring for wear and excess clearance.

Shaft Sleeve

Check for any damage to gasket surface on impeller end, O-ring groove on motor end, or outside diameter where rubber bellow of mechanical seal contacts.

Mechanical Seal

It is not recommended that the mechanical seal be reused unless the pump has never been run. A mechanical seal is like a gasket in this respect. Using an old one leaves too much chance of failure to make the gamble worthwhile, considering the usual cost of installing and removing a pump from it's system.

Motor or Frame Shaft

Check the shaft for any bent condition by installing the shaft sleeve, clamping a dial indicator to the motor face and reading runout at center of sleeve while turning shaft by hand. Maximum allowable runout is .002 inches for proper performance of mechanical seal. Anything beyond this will require repairs to the motor, which are beyond the scope of these instructions. Check motor fan and shroud for damage and clean, if necessary.



Motor and Pump Assembly

Assembly Procedure

The PowerSoak pumps are easy to put together. The hardest part, requiring the most care, is installation of the mechanical seal parts.

Study the exploded diagram and become familiar with the name of each part. The diagram shows the relative order of assembly, but also **READ THE FOLLOWING INSTRUCTIONS.**

1. **Make sure all of the parts are clean and ready for assembly.** This means no dirt or pieces of old gasket in the joints between the motor, adapter, and casing. Make sure the parts around mechanical seal are clean. Dirt and misalignment will ruin a mechanical seal.
2. **Install the shaft sleeve o-ring in the place against the motor shaft shoulder.** Don't let it be cut by the sharp edges of the keyway.
3. **Push the mechanical seal seat squarely in the adapter.** Use fingers only. A little liquid soap (or light oil if soap not available) can be wiped on the outside of the seat ring to make it slip easily into position. Don't let it be cut by the edges of the adapter. Don't install the adapter on the motor face yet.
4. **Check the shaft sleeve fit on the motor shaft.** It should slide easily into place. If it doesn't, find out why. Do not try to drive the shaft sleeve onto the shaft with a hammer. Check to make sure there are no score marks or scratches on the sleeve.
5. **Install the adapter and tighten the cap screws, which hold it to the motor face.**
6. **Remove any dirt particles and coat the lapped face of the mechanical seal with clean SAE 10 or SAE 20 oil. DO NOT USE GREASE.**
7. **Slide the shaft sleeve on the shaft** so that it covers the shaft sleeve o-ring and butts against the shoulder.
8. **Coat the shaft sleeve lightly with liquid soap** (or light oil if soap not available).
9. **Carefully remove any particles from the lapped face of the carbon washer (part of the mechanical seal) and coat it with clean SAE 10 or SAE 20 oil. DO NOT USE GREASE.**



Motor and Pump Assembly Assembly Procedure - Continued

10. **Install the mechanical seal on the shaft sleeve by hand.** A twisting motion may be needed to make it ride smoothly over the shoulders on the sleeve. Push it by hand until it contacts the seat, make sure the spring and spring holder line up properly. *(see note)
11. **Install the snap ring** using one hand to hold the snap ring pliers and the other hand to compress the spring. When the spring pressure is released, the spring will push the shaft sleeve outward, exposing the shaft sleeve o-ring to view temporarily.
12. **Install the impeller key**, first twisting the shaft sleeve on the shaft until the keyways line up.
13. Install the shaft sleeve gasket.
14. **Place the impeller on the shaft engaging the key.**
15. **Put the impeller screw gasket, impeller washer, and impeller washer gasket together on the impeller screw as an assembly.**
16. **Install the impeller screw subassemblies.** With one hand, push the impeller back against the mechanical seal spring and with the other hand turn the impeller screw in *hand tight*.
17. **Check to see if the shaft sleeve has moved to its final position** covering most of the shaft sleeve o-ring.
18. **Tighten the impeller screw** to 15 ft-lb. torque.
19. **Install the casing gasket** on the shoulder of the adapter.
20. **Install the casing** and tighten all the casing screws.
21. **Turn the motor shaft and check for any bindings or rubs** caused by such things as damaged or misaligned parts. Re-check all casing bolts for tightness. Tighten casing bolts one at a time, turning the motor shaft, until rub disappears.

*NOTE

An optional procedure for assembly of the mechanical seal consists of mounting the mechanical seal and the snap ring on the sleeve as a subassembly, which is then placed in position on the motor shaft. Experienced pump mechanics may find that this is more convenient as long as they recognize that this way introduces some additional hazards of damaging or improper assembly of precision seal parts.



Installation Guide

The installation and initial operational check of your new system must be performed only by licensed and certified plumbers and electricians.



Be sure to follow all applicable national and local electrical codes when installing the electrical supply and/or a new breaker. **DO NOT** connect the system using a power cord and plug or an extension cord of any kind.



Please refer to the detailed installation instructions that were sent with your *Power Soak* system.

Providing Proper Electrical Service

The requirements of your new system are on the serial number plate located on the front of the wash sink, adjacent to the control panel enclosure and inside the enclosure itself.

All *PowerSoak* systems have a single point electrical connection, and a dedicated circuit is required.



Providing Proper Electrical Service

The system is completely pre-wired and tested at the factory, and a hard-wired connection from an appropriate power source junction box is all that is required.

The installer is to provide a disconnect that should be incorporated in the fixed wiring. Properly sized watertight conduit, fittings and parts are required, as well as the appropriate gauge wire.

If your system is a “left-to-right” unit, you should locate the power source junction box at the left end of the system. (The opposite would be true for a “right-to-left” system.)

Ideally, the junction box should be located on the wall directly behind the pump motor and control panel.

A wiring diagram is located in the system’s control panel enclosure. Specific part numbers and part information can be obtained from the factory by calling **800-444-9624**.

Plumbing Requirements

Your unit requires the following plumbing connections:

- 3/4” (19mm) or 1/2” (12 mm) hot and cold water supply lines.
- One wastewater connection (minimum 1 1/2” / 38mm).



Power Soak is a registered trademark of Cantrell Industries, Inc.
The Power Soak design and concept is fully patented.

13910 Kessler Drive, Grandview, MO 64030
Phone: (816) 761-3250 Fax: (816) 761-0544
(800) 444-9624
www.powersoak.com