



Solstice Gas ROV Fryers SSHLV Series Service Manual



RETAIN AND STORE THIS MANUAL IN A SAFE PLACE FOR FUTURE USE

⚠ DANGER ⚠

Improper installation, operation, adjustment, maintenance, all alterations or service, and unauthorized alterations or modifications can cause property damage, injury or death. Read the installation, operating and service manuals thoroughly before installing or servicing this equipment.

⚠ WARNING ⚠

DO NOT supply the appliance with a gas that is not indicated on the data plate. If conversion of the appliance is required, contact your dealer or authorized service agent.

⚠ DANGER ⚠

Only qualified service personnel may service or convert this appliance to use a gas other than that for which it was originally manufactured. Improper conversion can lead to property damage, injury or death.

⚠ DANGER ⚠

Prior to moving, testing, maintaining or repairing your appliance, ensure it is emptied of all oil, cool, disconnected from gas and all electrical power. Failure to do so may result in property damage, damage to your fryer, injury or death.

⚠ DANGER ⚠

No structural material on the fryer should be altered or removed to accommodate placement of the fryer under a hood, or any other reason. Unauthorized modifications could cause improper combustion and excess heat, causing property damage, injury and death.

⚠ DANGER ⚠

Adequate means must be provided to limit the movement of this appliance without depending on the gas line. Single fryers equipped with legs must be stabilized by installing anchor straps. All fryers equipped with casters must be stabilized by installing restraining lanyards. If a flexible gas line is in use, an additional restraining lanyard must be connected at all times when the fryer is in use. The restraining cable must NOT exceed 80% of the length of the flexible gas line. Failure to do so may result in ruptured gas lines and property damage, injury and death.

⚠ DANGER ⚠

DO NOT sit or stand on this appliance. The appliance's top deck, door, front panel, tank, splash back, tank cover, workshelf, drain board are not steps. Serious injury will result from slipping, falling or contact with hot liquids causing property damage, injurious severe burns and/or death.

⚠ DANGER ⚠

NEVER use the appliance as a step for cleaning or accessing the ventilation hood. Serious injury will result from slipping, falling or contact with hot liquids causing property damage, injurious severe burns and/or death.

⚠ DANGER ⚠

Do not store or use gasoline, store or spray aerosols or other flammable liquids or vapors in the vicinity of this or any other appliance. Appliances incorporate open flames and/or high heat that will ignite flammable vapors causing property damage, injury and death.

⚠ DANGER ⚠

Instructions to be followed, in the event an operator smells/detects a gas leak, must be posted in a prominent location. This information can be obtained from your local gas company or supplier. Failure to post the instructions could leave an active gas leak unresolved, leading to fire, property damage, injury and death.

⚠ DANGER ⚠

The contents of the crumb catch and/or filter pan of any filter system must be emptied into a fireproof container at the end of the frying operation each day. Some food particles can spontaneously combust into flames if left soaking in certain oil/shortening materials, causing fire, property damage, injury and death.

⚠ DANGER ⚠

Any and all spilled oil, water or other liquids that occurs as a result of operation, cleaning, maintenance or repair of this fryer should immediately be cleaned and dried. Failure to do so can create a slippery surface resulting in falling/impact injury or death.

⚠ DANGER ⚠

Check for gas leaks after installation or servicing of a gas fryer. Apply a leak detection solution to all connections and joints to ensure there are no bubbles or leaks. Failure to check for and correct any leaks could lead to fire and/or explosion, property damage, injury and death.

⚠ WARNING ⚠

DO NOT use the filter pan to transport oil, hot or cold. The filter pan is not designed to transport oil. Serious injury will result from slipping, falling or contact with hot liquids causing property damage, injurious severe burns and/or death.

⚠ WARNING ⚠

DO NOT remove frypot fittings before all oil is drained from the tank. Serious injury will result from slipping, falling or contact with hot liquids causing property damage, injurious severe burns and/or death.

⚠ WARNING ⚠

For appliances equipped with manual (opposed to automated) filtration, shut down the appliance completely when the shortening, fat or oil is being drained from the appliance. This will prevent the appliance inadvertently heating up during the draining and filtering process.

⚠ WARNING ⚠

This appliance must be installed and used in such a way that any water cannot contact the fat or oil. Water will react violently with hot fat or oil causing severe burns, injury or death.

⚠ WARNING ⚠

Keep all items and hands out of drains. Automated actuators may close without notice causing damage to the fryer and personal injury.

⚠ WARNING ⚠

This appliance is NOT jet stream approved. Do not clean the appliance with a water jet. Use of any pressurized water jet will cause damage to the fryer and personal injury.

⚠ WARNING ⚠

This appliance is intended for indoor use only. Do NOT use outdoors.

⚠ WARNING ⚠

This appliance is not intended for use by persons (including children) with reduced physical, sensory or mental capabilities, or lack of experience and knowledge. Property damage, personal injury or death can result from unqualified operators.

⚠ CAUTION ⚠

Use caution and wear appropriate safety equipment to avoid contact with hot oil or surfaces. Hot oil and surfaces can cause severe burns and injury.

⚠ CAUTION ⚠

Do not bang fry baskets or other utensils on the joining strips between battered fry pots. Banging frybaskets or any other utensil on the joining strip will distort and promote oil migration inside the fryer.

⚠ CAUTION ⚠

NEVER run water through the filter pump. Water will damage the pump seals and render the pump inoperable/ It will also void the warranty on the filter pump.

NOTE

Some US states require any gas appliance to be installed by a state licensed plumber or pipe fitter. Check with your local municipality prior to installation.

NOTE

This equipment must be installed in accordance with appropriate local and national codes in the state, country and/or region in the appliance is to be operated. Contact your local gas authority for guidance.

NOTE

This equipment is to be installed in compliance with the basic plumbing code of the *Building Officials and Code Administration International (BOCA)* and the Food Service Sanitation Manual of the *U.S Food and Drug Administration*.

NOTE

Photos and drawings used in this manual are intended to illustrate operational, cleaning and technical procedures and may not conform to onsite management operational procedures.

NOTE

This appliance is intended to be used for commercial applications: For example in kitchens of restaurants, canteens, hospitals and in commercial enterprises such as bakeries, butcheries, etc. but NOT for continuous mass production of food.

NOTE

This appliance is intended for professional use only and is to be operated by qualified, trained personnel only. A Pitco *Authorized Service Agent (ASA)* or other qualified professional must perform installation, maintenance and repairs. Installation or repairs by unqualified personnel will void the manufacturer's warranty. See chapter one for descriptions of qualified personnel.

NOTE

If, during the warranty period, the end user uses a part for this Pitco appliance other than an **UNMODIFIED** new part purchased directly from Pitco or any of Pitco’s authorized service agents, and/or the part being used is modified from its original configuration, **THE WARRANTY WILL BE VOID**. Further, Pitco Frialator and its affiliates will not be liable for any claims, damages or expenses incurred by the customer which arise directly or indirectly, in whole or in part, due to the installation of any modified part and/or part received from an unauthorized servicer/supplier.

1 Notice

In the event of problems or questions about your order, contact the Pitco Frialator factory at **(603) 225-6684**.

For non-routine maintenance or repairs, or for service information, contact your local Pitco Frialator Authorized Service and Parts representative (ASAP). In order to assist you quickly, your Pitco Frialator ASAP or Service Department representative requires certain information about your equipment. Most of this information is printed on a data plate affixed to the inside of the fryer door. Part numbers are found in the Service and Parts Manual. Parts orders may be placed directly with your local ASAP or distributor. A list of Pitco Factory Authorized Service and Parts is located on the Pitco Frialator website at www.pitco.com. If you do not have access to this list, contact the Pitco Frialator Service Department at **(603) 225-6684** or by email at:

Literature Fulfillment (brochures, spec sheets, manuals)

Literature@Pitco.com

Non-urgent service parts inquiries. i.e. (part numbers or reference information)

parts@pitco.com

Non-urgent technical service questions

service@pitco.com

Non-urgent warranty questions

warranty@pitco.com

MAILING ADDRESS

Pitco Frialator
P.O. Box 501
Concord, NH 03302-0501

SHIPPING ADDRESS

Pitco Frialator
10 Ferry Street
Concord, NH 03301

EQUIPMENT REFERENECE INFORMATION

Model #: _____ Serial #: _____ Date Purchased: _____

TABLE OF CONTENTS

1 Notice5

2 General.....8

 2.1 Serial Numbers.....9

 2.2 Safety Information10

 2.2.1 Installation, Operating, and Service Personnel10

 2.3 Definitions.....10

 2.3.1 Qualified and/or Authorized Operating Personnel10

 2.3.2 Qualified Installation Personnel10

 2.4 Shipping Damage Claim Procedure11

3 Theory of Operation11

 3.1 The Matchless Ignition System11

 3.2 Auto Filtration Boards.....12

 3.3 Thermostats14

 3.4 Fryer Sequence Operation14

 3.5 Heating System14

 3.6 Safety System15

 3.7 Filter System (Manual Filtration Only)15

 3.8 Basket Lift (Optional).....16

 3.9 Auto Top Off – ATO (Optional).....16

 3.10 Automated Filtration (Optional)17

4 Accessing Fryer for Servicing18

5 Replacing the Controllers19

 5.1 Removing the Controller Front Panel Bezel19

6 Manual Operation of Drain and Return (Auto Filter Only).....20

7 Blocked Drain (Auto Filter Only).....21

 7.1 Replacing the Relay Board and Paper22

8 Checking Resistance23

 8.1 Checking the Resistance of the Transformer23

 8.2 Diagram Identifying Terminals for Second Resistance24

 8.3 Checking the Resistance of the DVI Switch24

 8.4 Checking the Resistance of the Hi-Limit25

 8.5 Checking the Resistance of the Temperature Probe26

9 Replacing Temperature Probe27

10 Replacing the Ignition Module and Hi-Limit29

11 Replacing an Igniter/Pilot Assembly30

12 Replacing Drain Valve with Actuator (Auto Filter Only).....31

13 Replacing the DC Power Supply.....33

14 Replacing Transformer/Power Box34

15 Changing Filter Pump Actuator35

16 Testing the Auto Top Off Probe (if equipped)36

17 Replacing the Auto Top Off Probe (If equipped).....38

18 Gas Conversion.....40

19 Replacing the Return Valve.....41

20 Replacing the Optional Flush Hose Assembly and Valve42

21 Replacing the Waste Oil and Components45

 21.1 Removing Rear Mounting Bracket45

 21.2 Removing the Check Valve46

22 Removing the Filter Pump from the Motor48

 22.1 Replacing Seal Kit48

23 Replacing the Drain Line or Gasket49

24	Replacing the Pump Relay and Circuit Breaker	50
24.1	Replacing the Circuit Breaker.....	50
24.2	Replacing the Pump Relay.....	51
25	Cleaning the Gas Valve Vent Tube	52
26	Checking the Gas Pressure	53
26.1	Taking a Supply Gas Pressure Reading	53
26.2	Taking a Manifold Gas Pressure Reading.....	55
26.3	Adjusting Manifold Gas Pressure	56
26.4	Adjusting Pilot Flame.....	56
27	Replacing the Self-Cleaning Burner Solenoid	57
28	Replacing the Gas Valve	58
29	Replacing the DVI Switch (Manual Filter Only)	60
30	Replacing the Burner Assembly	61
30.1	Replacing the Burner(s)	61
30.2	Replacing the Burner Assembly	63
31	Replacing the Frypot	64
32	Replacing the Basket Lift Components	68
32.1	Removing the Basket Lift Cover.....	68
32.2	Replacing the Basket Lift Transformer	68
32.3	Replacing the Basket Lift Driver Board	69
32.4	Adjusting the Magnetic Sensor.....	70
32.5	Replacing the Basket Lift Actuator	70
33	Replacing the Filter Pump and Motor	72
33.1	Removing the Filter Pump and Motor.....	72
34	Information Charts/Tables	75
34.1	Temperature Probe Resistance Chart.....	76
34.2	Orifice Size Chart	77
34.3	Orifice Size at Sea Level Chart	78
35	Simplified Wiring Diagrams	79
35.1	Wiring Diagram – Heat Control Wiring Left & Right (ROV)	79
35.2	Wiring Diagram – Auto Filter Board (AFB2) Wiring (ROV)	80
35.3	Wiring Diagram – Connector Locations Detail AFB2 W/Jib & No Bulk Oil Option (ROV) ...	81
35.4	Wiring Diagram – Calibration Test Points and Indicators (ROV).....	82
35.5	Wiring Diagram – AC & DC Control Voltage Supplies (ROV)	83
35.6	Wiring Diagram – Basket Lift Option & Connector Locations (ROV).....	84
35.7	Wiring Diagram – Filter Pump Options 208V-240V (ROV).....	85
35.8	Wiring Diagram – Full Vat with SCB.....	86
35.9	Wiring Diagram – Basket Lifts	87
35.10	Wiring Diagram – Filter Motor 115V-60Hz.....	88
35.11	Wiring Diagrams – Filter Motor 208-240V	89

2 General

Read the instructions in this manual thoroughly before attempting to operate this equipment. This manual covers all configurations of Pitco SSHLV gas models. The fryers in this model family have most parts in common, and when discussed as a group, will be referred to as SSHLV fryers.

The SSHLV fryers feature a low oil volume frying vat, optional automatic oil top off and optional automated filtration unit. The Solstice design features a large round drain, which ensures that fries and other debris will be washed into the filter pan. The SSHLV fryers are controlled with an I12 + Controller. Fryers in this series come in full- or split-vat arrangements, and can be purchased in batteries of up to five fryers.

2.1 Serial Numbers



Serial Numbers

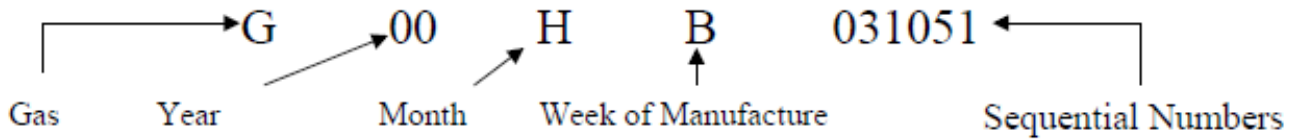

G = Gas All Models of Gas Fryers & Broilers

E = Electric All Models of Electric Fryers

F = Filters All Filters

Months

A=January

B = February

C = March

D = April

E=May

F= June

G=July

H= August

J=September

K=October

L=November

M=December

NOTE

If, parts returned to the factory under warranty are found to be a functional/serviceable, Pitco may, at its discretion, decline warranty reimbursement and may charge for replacement parts.

2.2 Safety Information

Before attempting to install, operate or service your unit, read the instructions in this manual thoroughly.

Throughout this manual, you will find notations enclosed in shaded boxes similar to the one below.

 **DANGER** 

Clean up any spilled oil or shortening immediately. Oil or shortening left on the floor creates a slipping hazard that will result in personal injury sustained from falling.

NOTE

NOTE boxes contain especially important information.

 **CAUTION** 

CAUTION boxes contain information about actions or conditions that *may cause or result in a malfunction of your system and/or minor personal injury.*

 **WARNING** 

WARNING boxes contain information about actions or conditions that *may cause or result in damage to your system and/or moderate personal injury*, and which may cause your system to malfunction.

 **DANGER** 

DANGER boxes contain information about actions or conditions that *may cause or result in serious injury or death to personnel*, and which may cause damage to your system and/or cause your system to malfunction.

2.2.1 Installation, Operating, and Service Personnel

Operating information for Pitco equipment has been prepared for use by qualified and/or authorized personnel only, as defined in Section 2.3. **All installation and service on Pitco equipment must be performed by qualified, certified, licensed, and/or authorized installation or service personnel, as defined in Section 2.3.2.**

2.3 Definitions

2.3.1 Qualified and/or Authorized Operating Personnel

Qualified/authorized operating personnel are those who have carefully read the information in this manual and have familiarized themselves with the equipment functions, or who have had previous experience and/or training with the operation of the equipment covered in this manual.

2.3.2 Qualified Installation Personnel

Qualified installation personnel are individuals, firms, corporations, and/or companies which, either in person or through a representative, are engaged in and are responsible for the installation of electrical appliances. Qualified personnel must be experienced in such work, be familiar with all electrical

precautions involved, and have complied with all requirements of applicable national and local codes. Qualified Service Personnel

Qualified service personnel are those who are familiar with Pitco equipment and who have been authorized by Pitco Frialator to perform service on the equipment. All authorized service personnel are required to be equipped with a complete set of service and parts manuals, and to stock a minimum amount of parts for Pitco equipment. Failure to use qualified service personnel will void the Pitco warranty on your equipment

2.4 Shipping Damage Claim Procedure

What to do if your equipment arrives damaged:

Please note that this equipment was carefully inspected and packed by skilled personnel before leaving the factory. The freight company assumes full responsibility for safe delivery upon acceptance of the equipment.

1. **File Claim for Damages Immediately** - regardless of extent of damage.
2. **Inspect For and Record All Visible Loss or Damage**, and ensure that this information is noted on the freight bill or express receipt and is signed by the person making the delivery.
3. **Concealed Loss or Damage**- If damage is unnoticed until equipment is unpacked, notify the freight company or carrier **immediately** upon discovery and file a concealed damage claim. This must be submitted within 15 days of date of delivery. Be sure to retain container for inspection.

PITCO DOES NOT ASSUME RESPONSIBILITY FOR DAMAGE OR LOSS INCURRED IN TRANSIT.

3 Theory of Operation

SSHLV Series gas fryers utilize a welded, stainless steel fryvat that is directly heated with high efficiency, atmospheric burner tubes. The atmospheric burner tubes eliminate the maintenance heavy and inefficient (over time due to clogging) blowers used in other fryers. Heat tubes provide as much as 80% more surface area for heat transfer than open vat fryers (tubeless), providing faster recovery without scorching the oil. Each tube, four total, is fitted with proprietary, incoloy baffles that are heated by air/gas jet emitted from our patented burners. The baffles transfer heat to the fryvat by means of infrared radiation and conduction plus convection flow from the air/gas jet. The tubular heat also allows for a "cold zone" below the tubes where cooking debris will settle at a temperature much lower than the cooking temperature. The lower temperature prevents the debris from carbonizing and oxidizing the cooking oil prematurely as typically found in non-tube style fryvats. In full-vat units, gas flow to the burners is regulated by one electromechanical gas valve. In split-vat units, each burner bank has its own valve to independently control each vat. All fryers in this series are equipped with 24 V AC gas valve systems, and all are configured with matchless ignition.

3.1 The Matchless Ignition System

An ignition module, mounted behind the gas valve, is connected to an ignitor/pilot assembly between the burners. The ignition module performs three important functions: provides an ignition spark, supplies voltage to the gas valve, and proofs the pilot flame. The module employs a four second time delay circuit (after flame sense) and a signal that activates the gas valve. Two types are currently used: A closed-box design is used in most fryers, but in some fryers built for export, the module is packaged differently. A single "one-spark" module is used on current production full-vat fryers. All dual-vat fryers use two single "one-spark" modules. The ignitor/pilot assembly consists of an igniter, a pilot tube/hood, and a flame sensor.

3.2 Auto Filtration Boards

All fryers in this series have an Auto-Filtration Board (AFB) located in the component box behind the control bezel. The AFB provides a “bus” between the controller and the fryer’s individual components without requiring additional wiring by using a communication protocol over a twisted pair, and allows the controller to execute commands from one central point. The heat control circuit is show below in Figure 1. This is the bottom left corner of the AFB. For a split vat, this is duplicated on the bottom right hand corner.

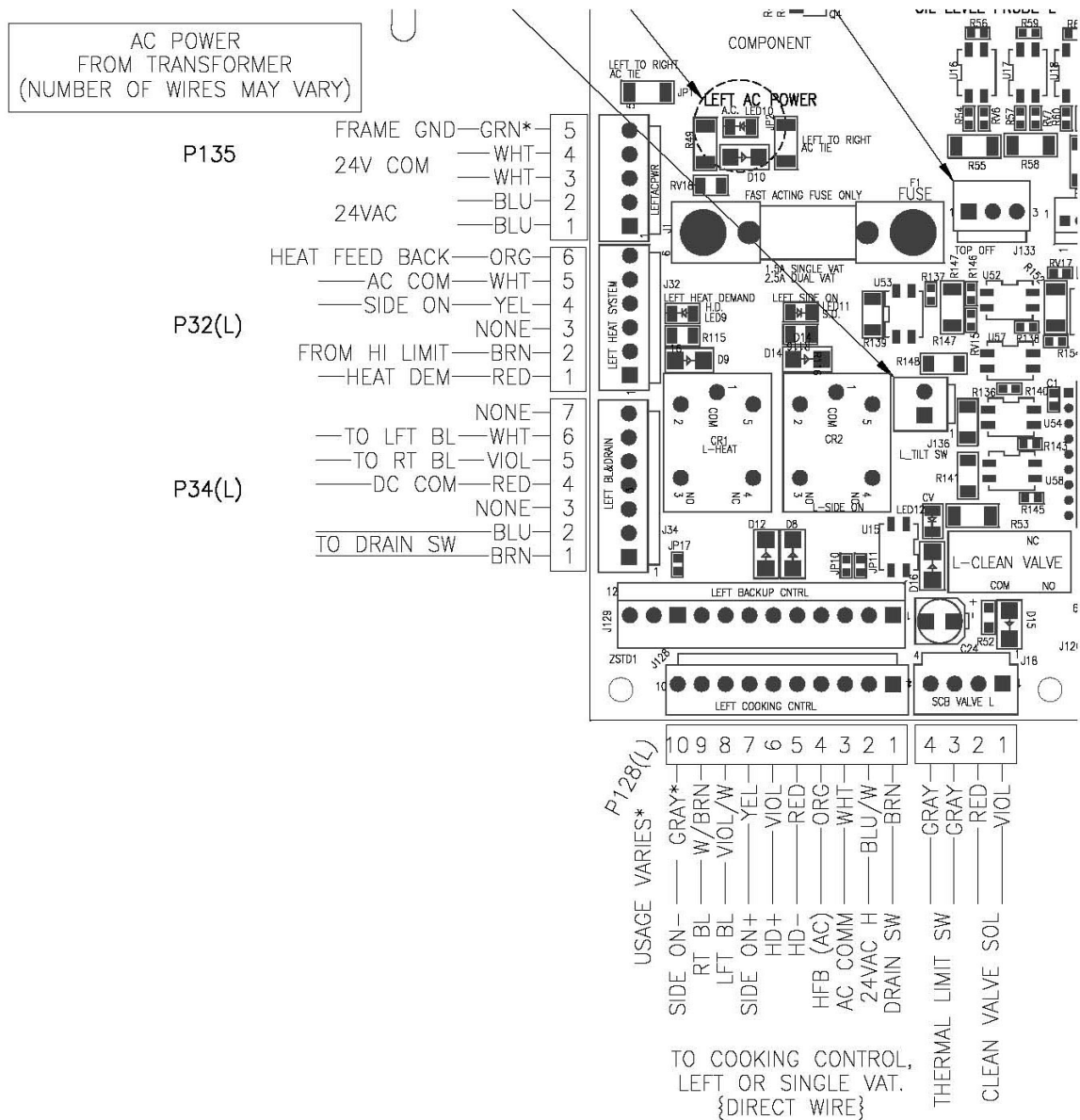

Figure 1 - Bottom left corner of Auto Filtration Board

3.3 Thermostats

SSHLV Series gas fryers have temperature probes located above and between the third and fourth heat tube of each fryvat (split vat fryers have two probes, one in each vat). SSSLV fryers, like all Solstice series fryers, use a thermistor style temperature probe. In this type of thermostat, the probe resistance varies directly with the temperature. That is, as the temperature rises, so does resistance. Circuitry in the controller monitors the probe resistance and controls burner firing when the resistance exceeds or falls below programmed temperatures (setpoints). SSSLV Series gas fryers are also equipped with a high-limit thermostat. In the event that the fryer fails to properly control the oil temperature, the high-limit thermostat prevents the fryer from overheating to the flash point. The high-limit thermostat acts as a normally closed power switch that opens when exposed to temperatures above 425°F to 450°F (218°C to 232°C).

3.4 Fryer Sequence Operation

The SSSLV fryer components function in specific order of operation. Knowing and understanding the sequence of fryer and components operation enables you to diagnose equipment failure more accurately.

3.5 Heating System

The unit is connected to line voltage:

- If Fuse F1 on the relay board is good:
 - The A.C. indicator is illuminated.
 - The controller is supplied with 24 VAC.
 - With the drain valve handle closed, the proximity switch supplies 24 VAC to the drain valve interlock (DVI) input at the controller.
 - 24 VAC is at the Side On (SO). relay COM contact.
- The controller is turned ON:
 - The SO indicator on the relay board is illuminated.
 - The SO relay is energized, closing the circuit.
 - With the roll out switch and hi-limit in the closed position, the ignition module receives 24VAC at terminal 6 (24 VAC).
- The ignition module:
 - Sends 24 VAC from terminal 3(PV) to the PV terminal on the gas valve.
 - Sends the igniter 15kv to spark.
 - Senses the flame once the pilot has lit and it sends 24 VAC at terminal 1(MV) and puts 24 VAC at the Heat Demand (HD) relay COM contact on the relay board. The HD relay on the relay board interrupts the 24 VAC supply to the gas valve until the controller calls for heat.

NOTE

When the controller is on, the pilot should always remain lit.

- The controller calls for heat:
 - The HD indicator on the relay board is illuminated.

- The HD relay is energized, closing the circuit sending 24 VAC to the MV terminal on the gas valve.
- The computer is supplied with a 24 VAC heat feedback (HFB) signal.

3.6 Safety System

When the roll out switch or hi-limit trips, it interrupts the 24 VAC supply to the ignition module.

- When the controller calls for heat, it does not receive a 24 VAC HFB. With approximately 90 seconds of HFB loss, the controller indicates an ignition failure or heat failure.
- After the roll out switch hi-limit is reset, turn the controller off and then back on for the unit to heat.

3.7 Filter System (Manual Filtration Only)

Pulling the BLUE drain valve handle will:

- Open the drain at the bottom of the fry vat
- Open the “Drain Valve Interlock” (DVI) magnetic switch disabling the heating system during filtration.

⚠WARNING⚠

Inspect the filter pan prior to pulling the BLUE DRAIN VALVE HANDLE to insure it is empty. If the filter pan has visible oil, opening the valve will result in hot oil overflow onto the floor resulting in slipping hazards, fall related injuries, serious burns or death.

- Push handle in to close Drain and enable DVI.

Pulling the RED return valve handle:

- Opens the return valve to that vat.
- Closes the pump proximity switch causing the “pump run” relay to be energized.
- The pump motor begins to run.
- Closing the return valve handle de-energizes the relay and the pump motor stops running and the return valve closes.
- The pump system is equipped with a circuit breaker which de-energizes the system and the heat tape (if equipped) in the event of over current. The circuit breaker must be in the “ON” position for the pump and heat tape to operate.

NOTE

Circuit Breaker should remain in the “ON” position at all times.

Pulling the BROWN waste oil valve will: (If equipped):

- Divert oil flow from the pump to the fry vat to user supplied waste oil plumbing through a Pitco supplied three way valve.
- The return piping system may be provided with optional heat tape to prevent solidification of solid shortening. The heat tape is low wattage and is on constantly to maintain liquid shortening in the line.

3.8 Basket Lift (Optional)

The basket lift is a self contained unit that requires a 120V, 208V, or 240V supply. With most fryer configurations, the power is supplied from the entrance box at the back of the fryer, but some configurations require power directly from a wall outlet.

- When power is supplied to basket lift assembly, the baskets lift to the up position.
- The baskets lower with a 24 VDC output from the controller.
- The basket lift control voltage is supplied from the controller
- The basket lift operational voltage is supplied from the line voltage supply that powers the transformer in the basket lift assembly.

3.9 Auto Top Off – ATO (Optional)

- If equipped, the optional Auto Top Off (ATO) adds small doses of oil from the “Jug in Box” or JIB when low oil conditions are detected. During frying, small amounts of oil are absorbed (called “drag out”) by the food and removed from the fryer. These small amounts eventually lead to replenishment with a “Top Off” event.
- The fryer cannot be filled from empty with the Auto Top Off option.
- The ATO uses the filter pump to move oil from the JIB to the fry vat when low oil conditions are sensed. A linear actuator redirects the pump flow from the JIB during a Top Off event.
- The ATO doesn’t not operate during a cook cycle to keep the oil hot during cooking. Adding room temperature oil during cooking would negatively impact the cook cycle and product.



- The ATO probe is located in a reservoir (or weir) at the front, top of the fry tank as pictured above:
- The probe reservoir must be free of debris & food particles to work properly.
- The ATO probe plugs into the Auto Top Off relay board behind the front control bezel.

The following conditions must be met for the ATO event to occur:

- The vat must be in idle condition, not cooking or melting, with display showing “Ready” or “Drop”. This display typically shows when the vat is within 20°F of cooking set-point.
- When the cooking control shows Ready, the oil level probe will take time to detect the low level condition. The lower the level the faster the response. The reverse is also true. Modestly low levels take longer to resolve. (< 3/8” below probe). Levels 1/2” below probe should detect in 3-1/2 minutes or less.

- Food debris, or oil caked onto probe may prevent ATO operation. Occasional probe cleaning when vat is empty and cool is recommended.
- Top off does not occur when the control is Off, Melting, Cooking, or Heating.

3.10 Automated Filtration (Optional)

- If equipped with an Automated Filtration system, the filtration works like any other Solstice Fryer except the manual handles (blue and red) are replaced with actuators (show below) to drain the fry vat and return oil to fry vat after filtering.

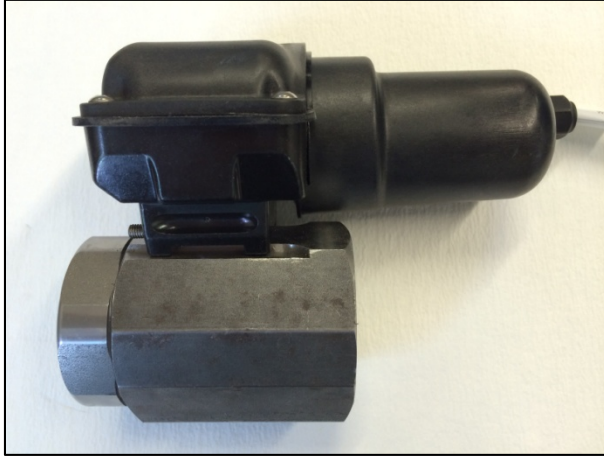

Drain Valve Actuator (top) with Drain Valve (below) 1

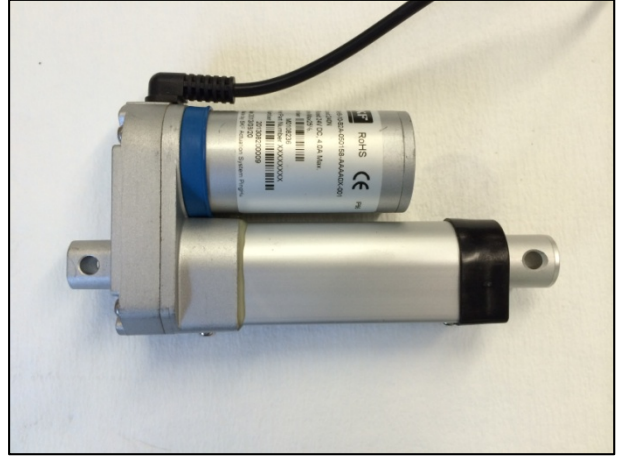

Linear Actuator 1

- The Automated Filtration system does not actuate “automatically”, user input is required.
- The actuators for the drain valve and return valve can be manually operated through the I12 computer. (See instructions in this manual, Section 6)
- When a pre-determined threshold (typically a user programmed number of cooks) is reached, the operator can be prompted to filter the cooking oil. Upon successful operator input, the system:
 - Begins an automated filtration process that first opens the drain valve and drains the oil into the filter pan.
 - Shortly after the drain valve opens, the linear actuator opens the return valve and the filter pump actuates. The filtering process operates for a pre-defined period of time (user programmable)
 - The drain valve closes and the pump continues to run, returning the freshly filtered oil to the fry vat.
 - When all the oil has been pumped back to the fry vat, the pump turns off and the return valve closes.
- The operator is queried to insure the vat is full. If the operator responds “NO”, the filter pump turns on and the return valve is opened to pump any remaining oil from the filter pan. When the operator responds “YES”, the fryer turns itself off and must be re-energized by the operator pressing the “ON” key to restore power and begin frying.

4 Accessing Fryer for Servicing

⚠ DANGER ⚠

Prior to moving, testing, maintaining or repairing your appliance, ensure it is emptied of all oil, cool, disconnected from gas and all electrical power. Failure to do so may result in property damage, damage to your fryer, injury or death.

1. Press off button on control panel.

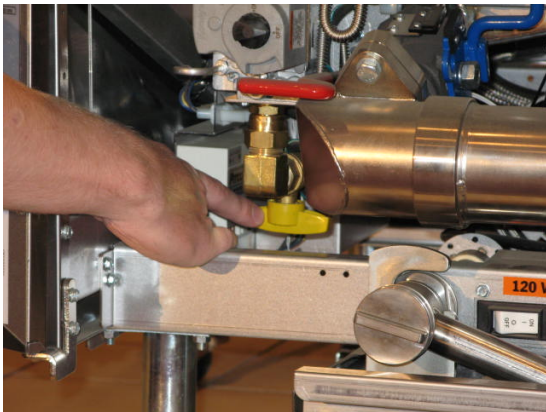
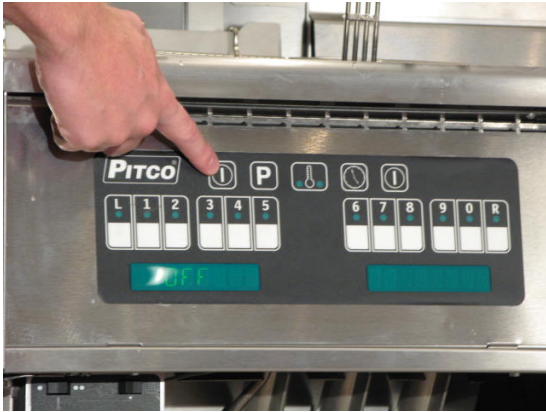

2. Shut off the individual gas supply line.

3. Unplug all power cords.



4. Shut off the main gas supply line to the unit.



5. Pull back collar to remove the quick disconnect gas line.



5 Replacing the Controllers

5.1 Removing the Controller Front Panel Bezel

1. Remove the two (2) screws on the controller panel using a Phillips screwdriver. (on a Dual unit you will need to remove the front panel divider).



(For a dual unit- remove the front panel divider)



2. Pull out the controller panel front bezel.

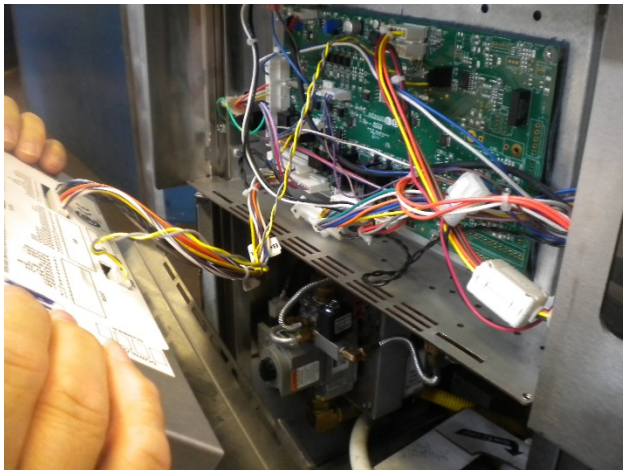

3. Disconnect the controller wiring harness.

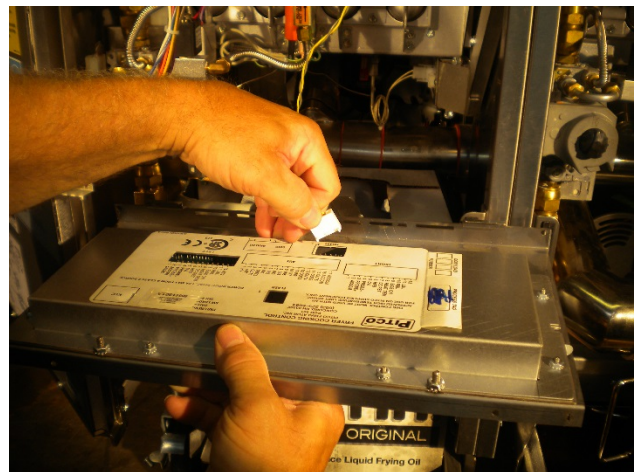
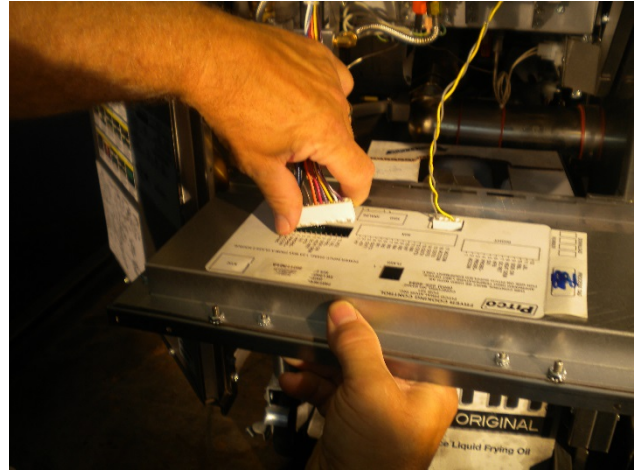

6 Manual Operation of Drain and Return (Auto Filter Only)

1. To open and/or close drain or return oil from filter pan manually, hold center filter button until display changes to fryer control (can be done with fryer on/off).



2. Pressing "L" key brings up the return mode, Pressing "Yes" key activates the motor and allows the pump to return oil from the filter pan to the vat. The pump/motor will remain on until you press "yes" key again to toggle off.



3. Pressing the "1" key brings up drain toggle option- press "YES" to open drain – drain will remain open until "YES" key is pressed again to toggle drain closed.



⚠ DANGER ⚠

Any and all spilled oil, water or other liquids that occurs as a result of operation, cleaning, maintenance or repair of this fryer should immediately be cleaned and dried. Failure to do so can create a slippery surface resulting in falling/impact injury or death.

7 Blocked Drain (Auto Filter Only)

1. Display of “Blocked Drain- retry”. The drain is not closing and the controller is not receiving the signal that shows that the drain has been closed.



NOTE

Use ONLY the supplied drain cleaning tool to remove any food debris or foreign object from drain. Use of any other tool can damage your drain valve and will void the warranty.

2. Once you cleared the drain press “YES” button (6) key. If drain closes and the controller receives the correct signal, check the drain again to insure the cleaning tool has been removed. Your fryer should go back into normal mode. If not, your controller will scroll “block drain”. You only have 3 times to try and unblock drain before controller goes into lock out.



3. If after three tries, the drain is still blocked the fryer will no longer operate. If you have a multi fryer system, the other fryers shouldn't be affected by this error. Contact Pitco Service or Authorized Service Person for assistance. There is NO reset from front controller panel.

4. If at any time you push “N” (0) key another scrolling message “FRYER WILL BECOME INOPERABLE”, “CONFIRM SHUT DOWN” message.



5. If you press the “N” (0) key then the message will revert to the display “Blocked Drain” as in number 1. If you press the “Y” (6) key message will display “Call Service – ERR” the fryer will no longer operate. If a multi fryer system the other fryers shouldn't be effected by this error.

⚠ WARNING ⚠

DO NOT UNPLUG FRYER FROM SUPPLY POWER. If the unit is unplugged and plugged in again, you WILL damage your drain valve and void the warranty.



7.1 Replacing the Relay Board and Paper

1. Remove the front panel. See “Removing the Controller Front Panel Bezel” in Section 5.1.
2. Disconnect all connections from the board.

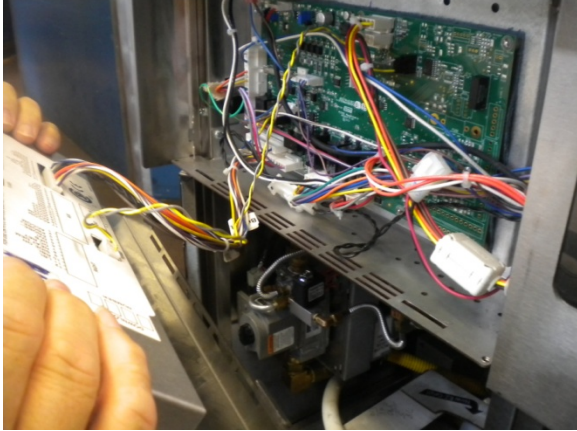

3. Remove the seven (7) screws, which hold down the relay board, using a small flathead screwdriver.

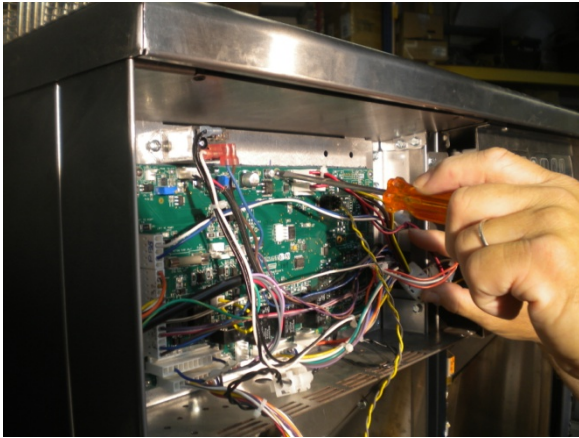

4. Remove the relay board and flip it over.

5. Remove the existing insulation paper and replace with a new insulator paper.

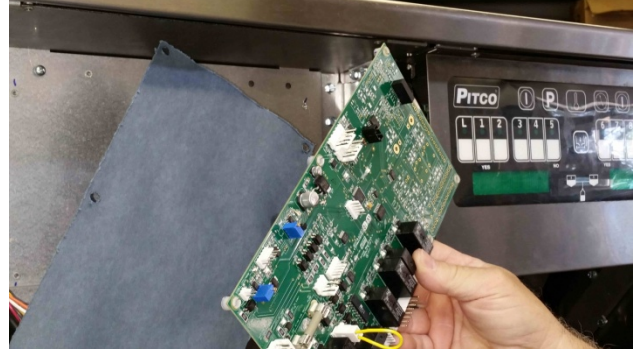

NOTE

Make sure the insulation paper doesn't have puncture marks in it.

6. Reinstall by following steps 1 through 5 in reverse.

8 Checking Resistance

8.1 Checking the Resistance of the Transformer

1. Disconnect all electrical power. Remove the front panel (see “Removing the Controller Front Panel Bezel” in Section 5.1).
2. Disconnect the secondary side terminals.

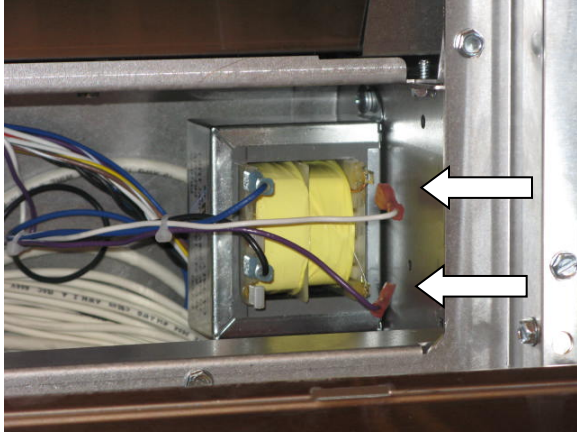

3. Connect the multimeter to the secondary terminals and check the resistance.



Secondary Terminals
.7 ohms +/- 20ohms

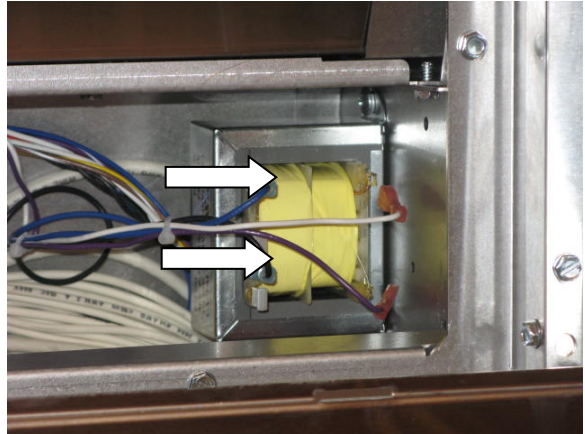

4. Disconnect the primary side terminals.



5. Connect the black lead of multimeter to the primary terminal marked “5” and check the resistance readings of taps in following chart on page 24.

8.2 Diagram Identifying Terminals for Second Resistance

PP10429			PP10428		
Secondary Resistance			Secondary Resistance		
TAP	Volts	Resistance	TAP	Volts	Resistance
10 - 6	24V	0.7	10 - 6	24V	0.6
Primary Resistance			Primary Resistance		
Tap	Volts	Resistance	Tap	Volts	Resistance
5 - 1	240V	30.4	5 - 1	480V	119.5
5 - 2	208V	25.3	5 - 2	440V	107.7
5 - 3	120V	9.9	5 - 3	380V	90.2

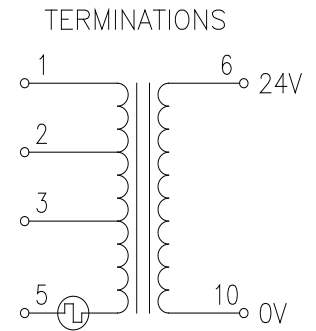

8.3 Checking the Resistance of the DVI Switch

1. Remove the Drain valve interlock (DVI) connection.

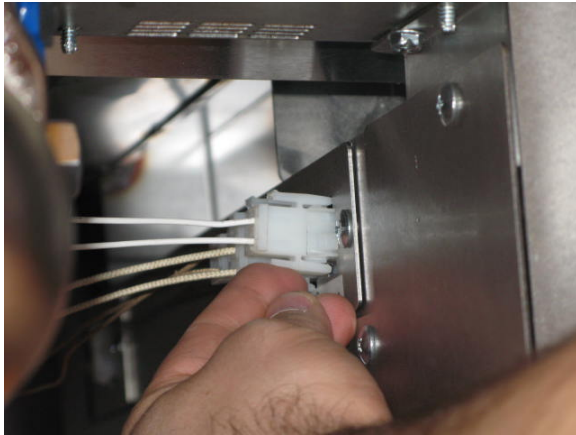

2. Connect the multimeter to the DVI leads and check the resistance.



DVI Resistance Table:

Valve Closed	Valve Open
Near Zero Ohm	Open Circuit

3. If measurements do not match the tables above, replace the DVI, following instructions in Section 29.

8.4 Checking the Resistance of the Hi-Limit

NOTE

If the Hi-limit is suspect, allow the fryer to cool to room temperature before performing this test. The high limit will remain OPEN until the oil temperature has dropped below the tripping threshold..

1. Unplug the Hi-Limit connection.

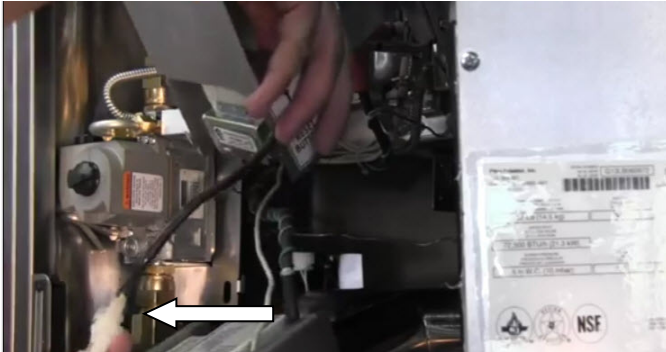

2. Connect the multimeter to the Hi-limit leads and check the resistance.



3. If the measurement shows an open circuit and/or greater than 0.5 ohms then the Hi-limit is bad and needs to be replaced or reset. see Section 10.
If there is a small resistance (0.1 – 0.2 ohms) reading, the Hi-limit is closed and ready to use, no replacement is required.

8.5 Checking the Resistance of the Temperature Probe

1. Remove the probe connection.

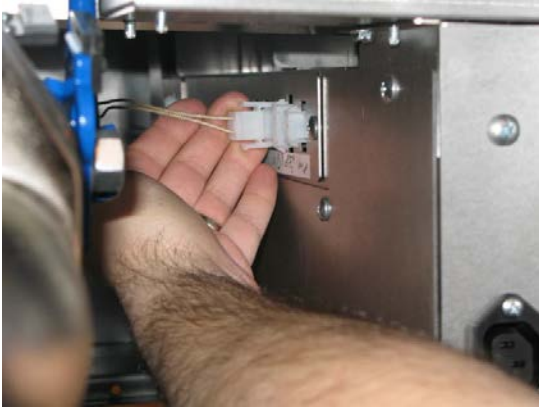

2. Connect the multimeter to the temperature probe leads and check the resistance.



” See Temperature Probe Resistance Chart on page 84”.

3. If the measurement on the temperature probe does not match the data in the Probe Resistance Chart, the temperature probe must be replaced per instructions in Section 9.

9 Replacing Temperature Probe

1. Remove Phillips screws from probe holder.



2. Slide probe holder off toward the back of the tank.



3. Bend horizontal section of probe straight up.



4. Loosen compression fitting, pull entire probe out of bottom of tank.

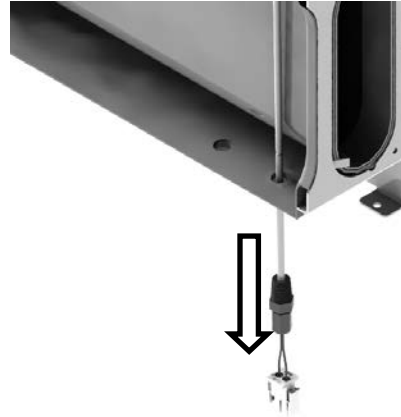

5. Install new probe from top.

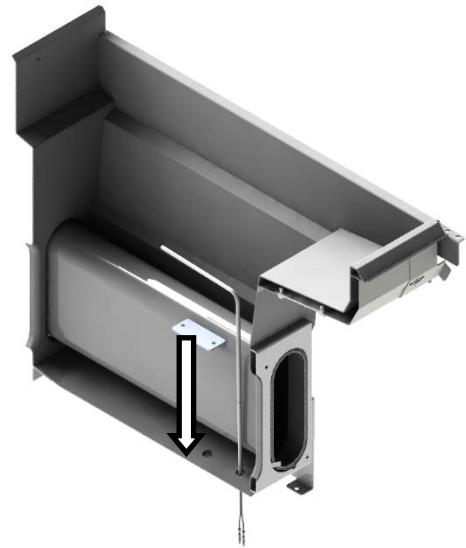

6. Install probe holder with Phillips screws. (Leave screws loose)

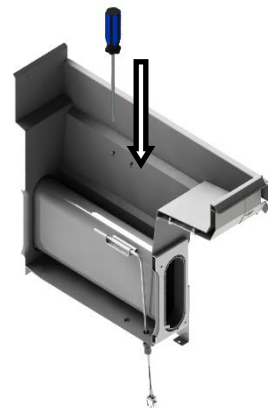

7. Install stuffing block in tank using high temperature food grade thread sealer. Install white housing on terminals. Tighten ferrule nut on stuffing block. Plug connector back in to entrance box (J7/J107). Tighten screws on probe holder.

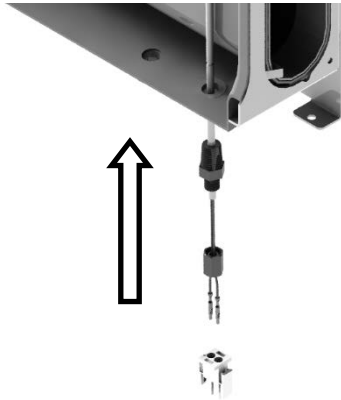

10 Replacing the Ignition Module and Hi-Limit

⚠ DANGER ⚠

Prior to moving, testing, maintaining or repairing any appliance, ensure it is emptied of all oil, cool, disconnected from gas and all electrical power. Failure to do so may result in property damage, damage to your fryer, injury or death.

1. Remove one (1) screw, which holds the ignition module using a 5/16 inch socket.



2. Remove 3 pin connector and 9 pin connector on top of the box. You may have to support the wiring to avoid tangling in the gas lines.

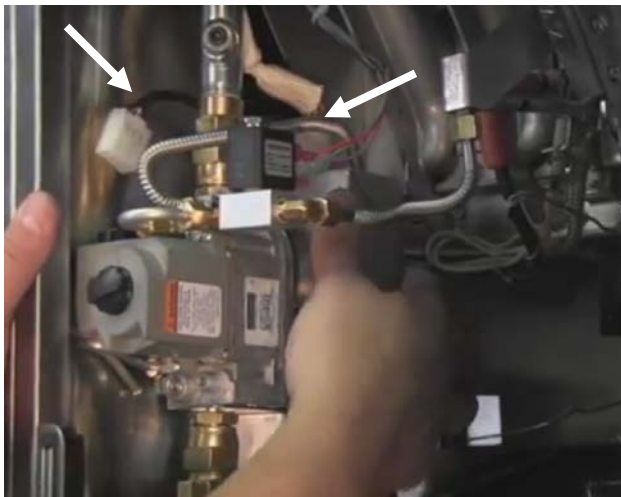

3. Lift the ignition box up and back towards the burners.



4. To open the ignition module box remove (2) two 5/16" screws that hold the cover plate on and slide the plate up to gain access to the ignition module. You now have access to ignition box or hi-limit to either test or replace.



5. Reinstall ignition module and hi-limit assembly. The box has 4 mounting tabs. Make sure the tabs are mounted correctly or the box will not seat properly when re-assembled.

6. Test for proper operation once job is complete.

⚠ DANGER ⚠

Check for gas leaks after installation or servicing of a gas fryer. Apply a leak detection solution to all connections and joints to ensure there are no bubbles or leaks. Failure to check for and correct any leaks could lead to fire and/or explosion, property damage, injury and death.

11 Replacing an Igniter/Pilot Assembly

⚠ DANGER ⚠

Prior to moving, testing, maintaining or repairing any appliance, ensure it is emptied of all oil, cool, disconnected from gas and all electrical power. Failure to do so may result in property damage, damage to your fryer, injury or death.

1. First cut and remove the zip ties which hold the flame sensor wire, then carefully remove the ignition wire boot and move it out of the way.



2. Remove the two (2) screws, which hold the pilot assembly using a 5/16" inch socket. One (1) of the screw, holds the ground wire, be careful when removing the screw.

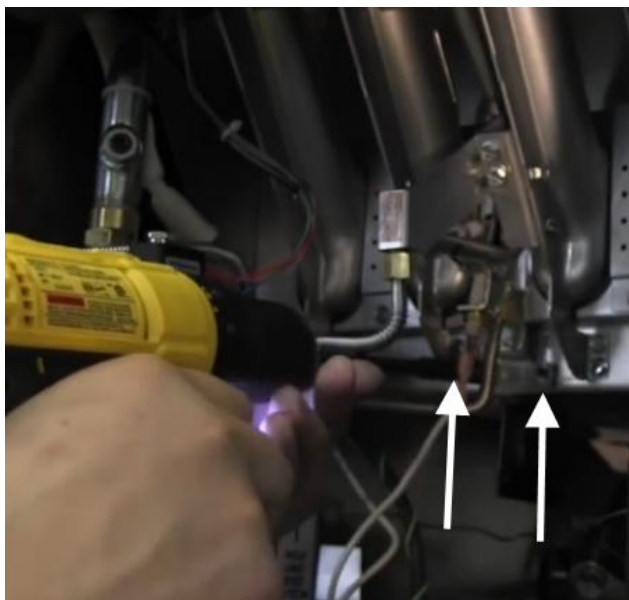

3. The pilot assembly consists of the pilot tube, flame hood, flame sensing rod and spark rod and also the pilot orifice. (If spark wire, flame sensor wire or ground wire need changing you will need to gain access to the ignition module page 29)

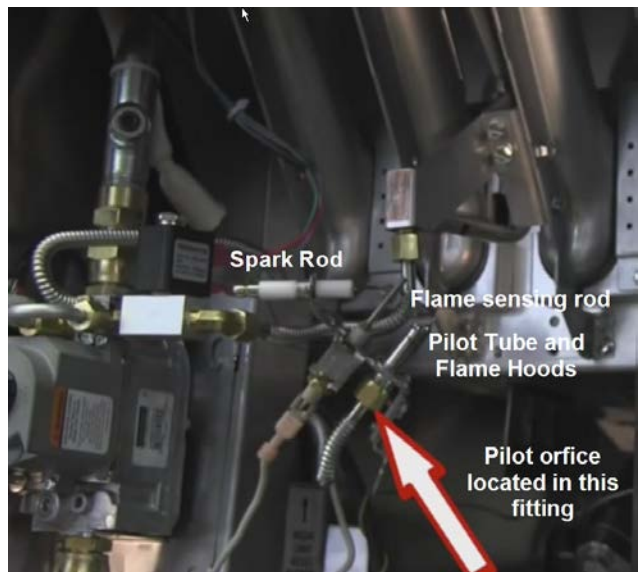

4. Verify that the spark is adjusted correctly. The purple spark should jump from the spark rod to the center of the flame hood. The spark should not jump to the flame sensing rod. Spark should be about 1/4 inch in length if adjusted properly.

⚠ DANGER ⚠

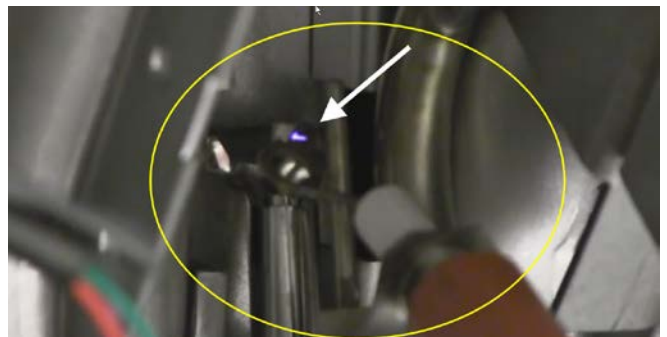

Check for gas leaks after installation or servicing of a gas fryer. Apply a leak detection solution to all connections and joints to ensure there are no bubbles or leaks. Failure to check for and correct any leaks could lead to fire and/or explosion, property damage, injury and death.

12 Replacing Drain Valve with Actuator (Auto Filter Only)

⚠ DANGER ⚠

Prior to moving, testing, maintaining or repairing any appliance, ensure it is emptied of all oil, cool, disconnected from gas and all electrical power. Failure to do so may result in property damage, damage to your fryer, injury or death.

1. Pitco ROV fryer with automated filtration uses a 24 VDC drain actuator for opening /closing the drain for each pot.

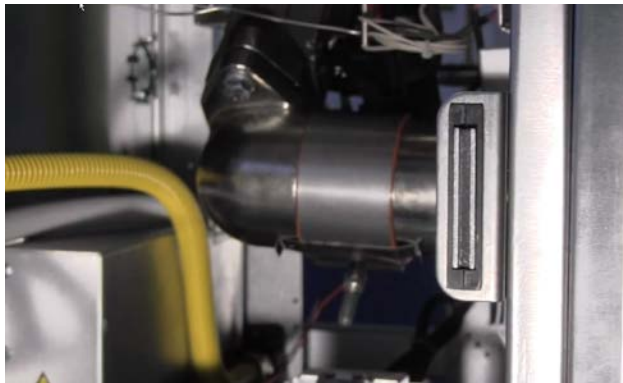

2. On the far left unit remove rubber protection on thread of retaining clamp screw. Remove the 2 bolts holding drain elbow in place. Loosen the retaining clamp holding the drain piping together and remove the drain elbow.

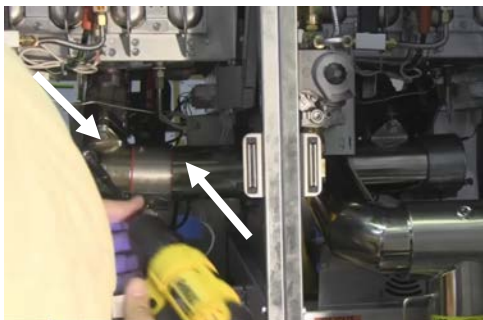

3. Once the elbow is removed, a small amount of oil will dip from drain, place a rag or paper towel in drain.



4. Using a 3/32 inch T handle hex key, loosen the mounting screws on the drain actuator. Remove the access panel rear of unit, unplug Molex connector for actuator. Once unplugged, slide the actuator off.



5. Follow steps 1 through 4 in reverse order to reinstall Actuator. **Remember to remove the rag or paper towels from the drain.**

⚠ DANGER ⚠

Any and all spilled oil, water or other liquids that occurs as a result of operation, cleaning, maintenance or repair of this fryer should immediately be cleaned and dried. Failure to do so can create a slippery surface resulting in falling/impact injury or death.

6. Make sure the red gasket is positioned between the elbow and drain tube where they join, slide retaining clamp over red gasket with position nut at bottom of drain line and tighten.

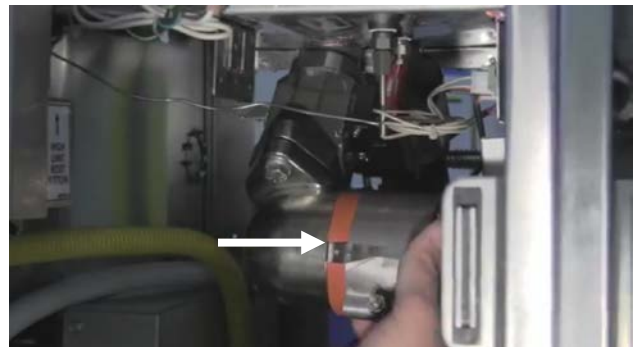

7. Don't forget gray rubber protector on the thread of the clamp so they don't get damaged.

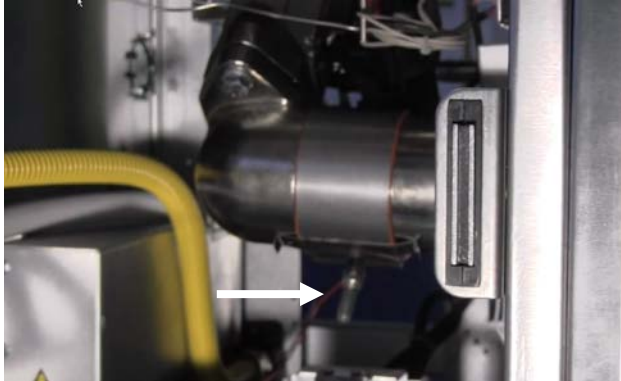

NOTE

When reassembling the actuator and valve, remember to have the arrows in the motor socket align with the end of the valve stem slot. The valve and the actuator are indexed to operate properly. Failure to align the index marks will result in the valve being opened when it supposed to be closed, and vice-versa.

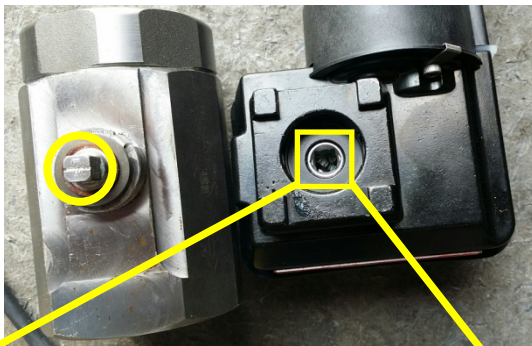

8. After servicing the powered drain system, If the drain remains open, the motor and valve assembly are not indexed correctly, remove motor, and align marks as instructed.
9. Should the drain valve need to be replaced, first remove actuator per instruction in section 4 of this chapter (drain valve comes with actuator installed), then remove the old drain valve from the end of the drain nipple and install the new drain valve and actuator.

NOTE

When installing the new drain valve, insure the arrow on the valve body is pointed AWAY from the drain nipple and towards the filter pan.



13 Replacing the DC Power Supply

⚠ DANGER ⚠

Prior to moving, testing, maintaining or repairing any appliance, ensure it is emptied of all oil, cool, disconnected from gas and all electrical power. Failure to do so may result in property damage, damage to your fryer, injury or death.

1. Remove the one (1) 5/16 inch hex screw on front of mounting box.

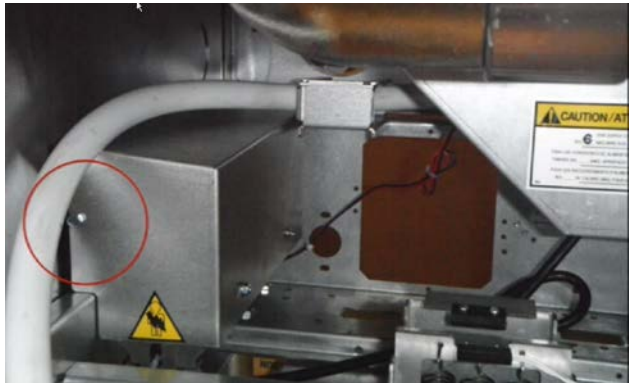

2. From the rear of the unit remove two (2) 5/16 hex screws from the small bracket that holds the hose for the JIB.

3. In the rear of the unit disconnect the black power cord from the entrance box, also remove the red/black Molex connector.

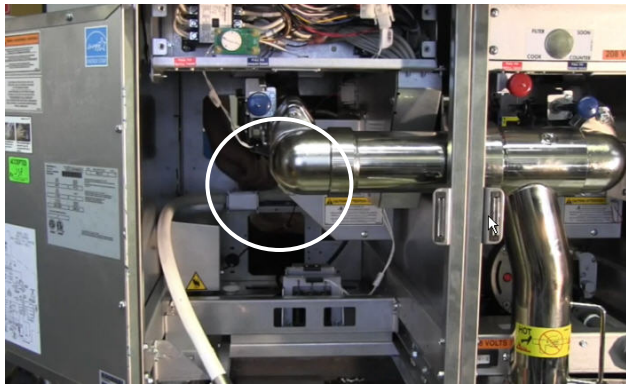

4. You can easily remove entire mounting box and power supply all in one piece.

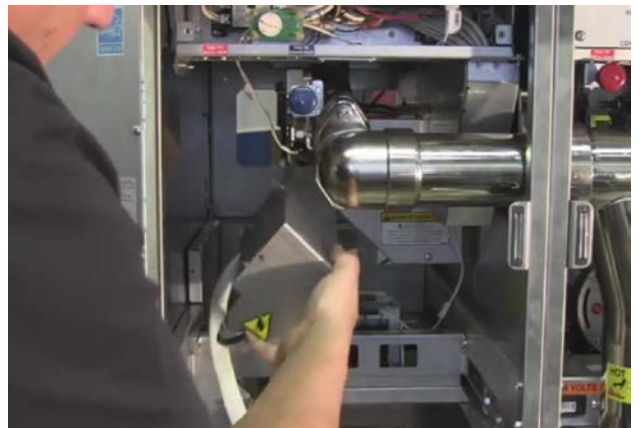

5. Follow steps 1 through 4 in reverse order to reinstall DC Power Supply.

14 Replacing Transformer/Power Box

⚠ DANGER ⚠

Prior to moving, testing, maintaining or repairing any appliance, ensure it is emptied of all oil, cool, disconnected from gas and all electrical power. Failure to do so may result in property damage, damage to your fryer, injury or death.

1. Remove service panel 4 screws. Entrance box is located in rear left hand side. Cut zip ties holding IEC connectors. Unplug Molex connector and black IEC connectors. Note: on multi bank units, it may be necessary to remove an oil return line to remove the power box. Make sure to reinstall and tighten this return line when finished.



2. Remove two (2) phillip screws at top of the entrance box.



3. Entrance box is located on sliding tabs, move box toward rear and down towards the floor to unmount from tabs.



4. Follow steps 1 through 3 in reverse order to Re-install entrance box. When reinstalling take caution not to bend tab on entrance box. Position tab on entrance box with sliding slot. Make sure to reapply zip ties to IEC connector to keep in place.

15 Changing Filter Pump Actuator

1. Pull two (2) re-usable cotter pins. One is located in the front of the actuator unit, second is located in the rear of the actuator.

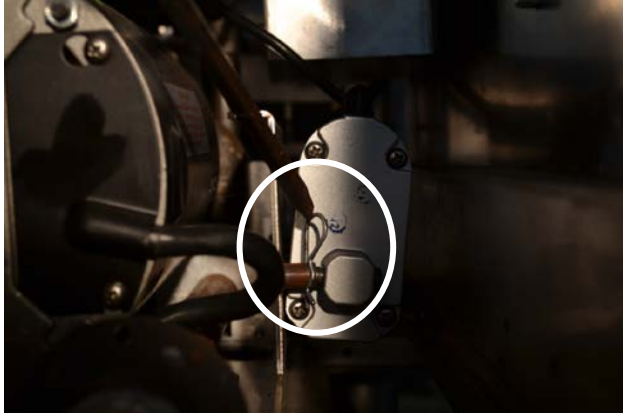

2. From the front, unplug the four pin molex connector for the actuator.

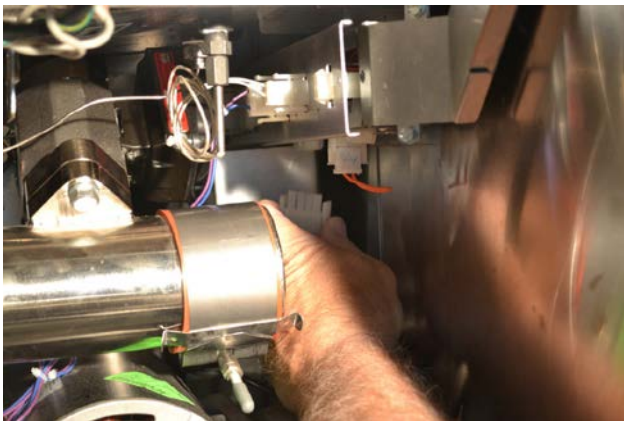

3. Remove filter pump actuator.



4. Follow steps 1 through 3 in reverse to reinstall new filter pump actuator.

NOTE

Re-assembly is simplified if the cotter pin in the rear is installed **BEFORE** the cotter pin in the front of the fryer.

16 Testing the Auto Top Off Probe (if equipped)

The Auto Top Off probe should be tested prior to replacement (follows this section).

1. Unplug connector J7 from the Auto Top Off Relay board. Measure the resistance with a multimeter (set to OHMS) between pins 1 and 2. The resistance should be approximately 150 ohms (+/- 2 ohms). Place either probe to the frame of the fryer and insure you have an open circuit (open to frame). If the probe measure outside this range, it must be replaced.

NOTE

Prior to measuring the probes resistance between pins 4 and 5, insure the fry vat contains enough oil to completely cover the probe.

2. Measure resistance with the multimeter between pins 4 and 5. The meter should read 167 OHMS at 350 degrees F. Measure the resistance with black lead to the frame to insure an open circuit reading (open to frame).
 - a. Resistance is dependent on the probe temperature. At room temperature, the resistance is 108 ohms. At cooking temperatures, the resistance can be as high as 167 ohms. If the probe measures within this range, it's OK.

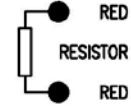
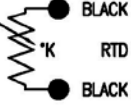
WIRING DIAGRAMS	P7 OF AFB2	UNPLUG PROBE AT J7. MEASURE OHMS
	1 2	150 OHMS FIXED. MUST BE OPEN TO FRAME.
	4 5	

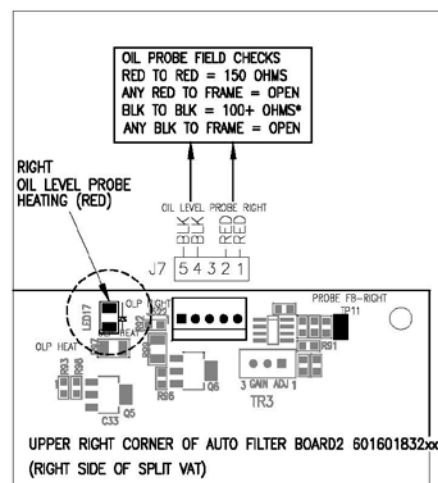
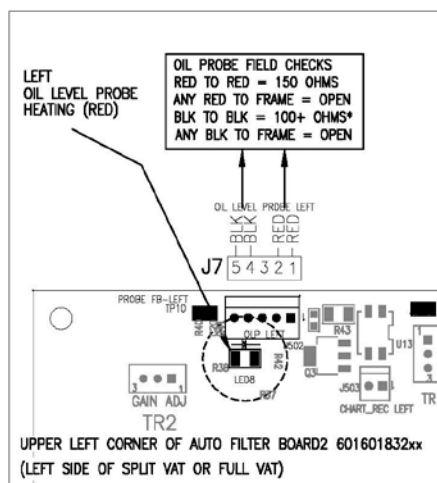
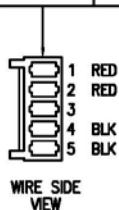

FLASH CODES FOR "INFO" LED, AMBER (LED22)

MODBUS COMM PORT		OIL LEVEL PROBE	
#1	DESCRIPTION	#5 RIGHT SIDE 2. DIGIT CODE	DESCRIPTION
11	—	21	—
12	LINK DOWN	31	—
13	—	32	DETECTING OIL
14	—	33	DETECTING OIL, RECENT TOP OFF
15	—	34	IDLE, WAITING FOR READY
16	—	35	PROBE FAULT
17	—	36	—
18	—	37	—
19	—	38	—
NONE (1)	—	NONE (2)	NONE (3)

FLASH CODES FOR STATUS INDICATOR (WITHOUT BULK OIL OPTION)

LED7	BIT 0	BIT 1	FLASH CODE
8	1	1	1
7	0	1	1
6	1	0	1
5	0	0	1
4	1	1	0
3	0	1	0
2	1	0	0
1	0	0	0

STATUS TO COOKING CONTROL AND ALL OTHER CABINETS (BULK OIL OPT)

LED7	RESOURCE	DESCRIPTION	BIT 0	BIT 1	BIT 2
8	IDLE	NO FILTER OPERATIONS	1	1	1
7	NONE	—	0	1	1
6	WASTE & PUMP	DISPOSING	1	0	1
5	NONE	—	0	0	1
4	DIVERT & PUMP	TOP OFF (1)	1	1	0
3	DRAIN ONLY	TOP OFF (2) NOT USED	0	1	0
2	PUMP ONLY	FILTERING	1	0	0
1	HOLD/LOCKOUT	DRAINING	0	0	0

DC & STATUS TO ALL CABINETS:

DC	STATUS
1	1
2	2
3	3
4	4
5	5

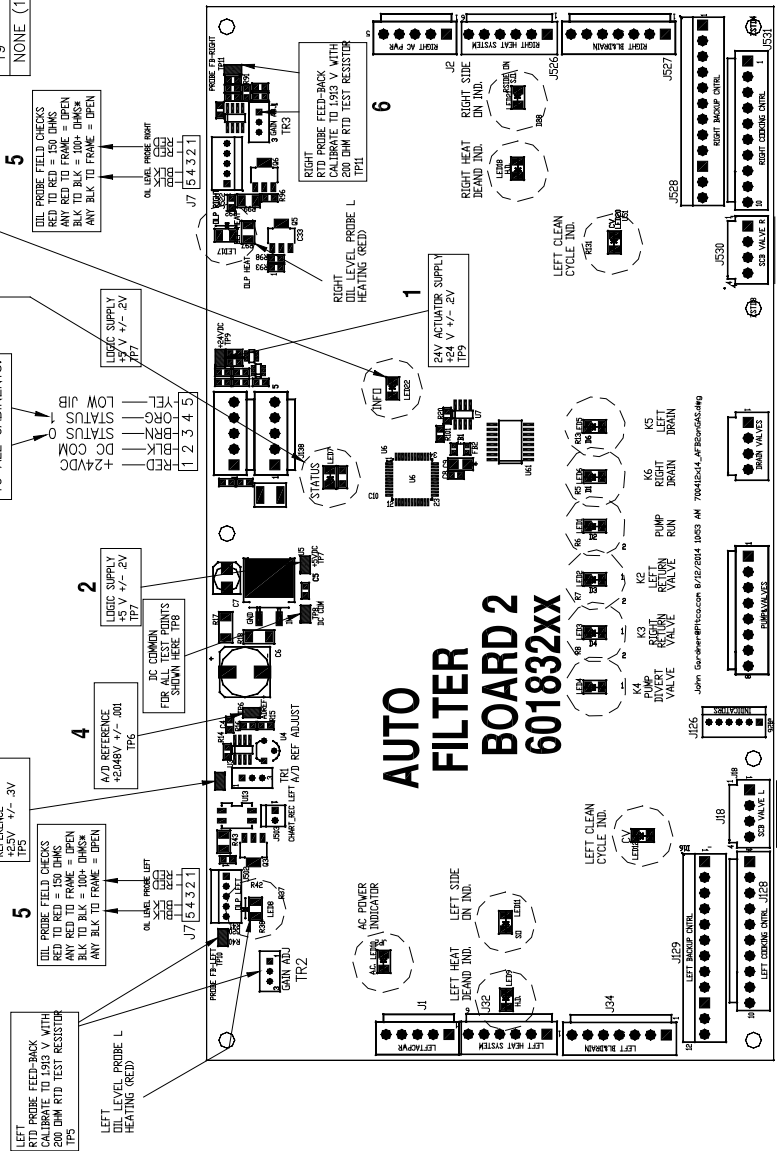

17 Replacing the Auto Top Off Probe (If equipped)

⚠ DANGER ⚠

Prior to moving, testing, maintaining or repairing any appliance, ensure it is emptied of all oil, cool, disconnected from gas and all electrical power. Failure to do so may result in property damage, damage to your fryer, injury or death.

1. Using a 5/16" nut driver. Remove two (2) screws from SCB runner tube.

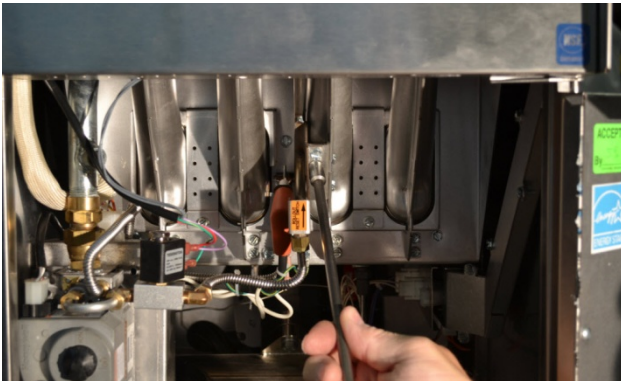

2. Remove orifice from tube.

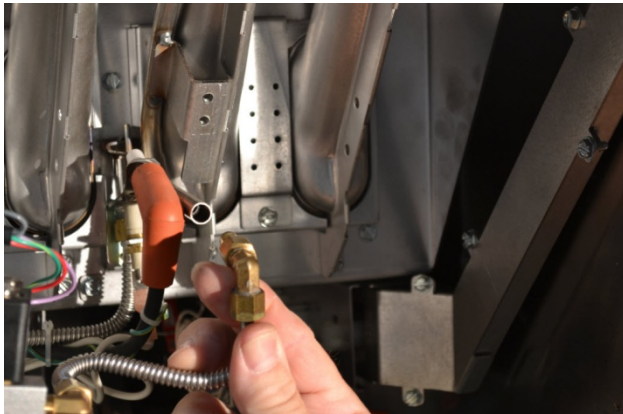

3. Remove two (2) screws from pilot assembly.



4. Use two (2) wrenches 1-1/16 inch & 15/16 inch to remove top connection of gas valve.



5. Drop down and out of way.

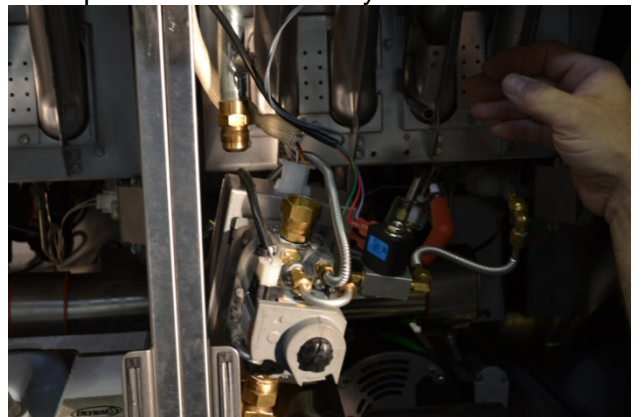

6. Remove five (5) screws from burner plate using 5/16 nut driver.



7. Position burner assembly out of the way, so you have access to DLP fitting.



8. Use ½ inch wrench to remove the probe.



9. Remove front panel divider and front panel using a phillip screw driver.

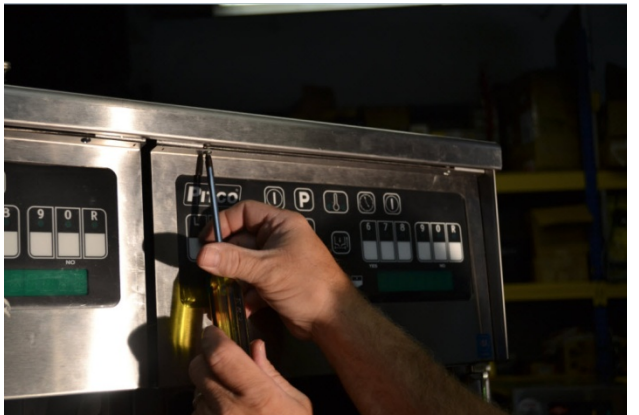

10. Unplug probe and replace with new probe.



11. Follow steps 1 through 11 in reverse to reinstall new probe.

18 Gas Conversion

⚠ DANGER ⚠

Only qualified service personnel may service or convert this appliance to use a gas other than that for which it was originally manufactured. Improper conversion can lead to property damage, injury or death.

1. Remove the pilot assembly. See “Replacing an Igniter/Pilot Assembly” in Section 11.
2. Remove the nut, which holds the pilot tube, using a 1/2 inch open-ended wrench.
3. Replace bullet orifice with one provide in the gas conversion kit.
4. Change the main burner orifice tips.

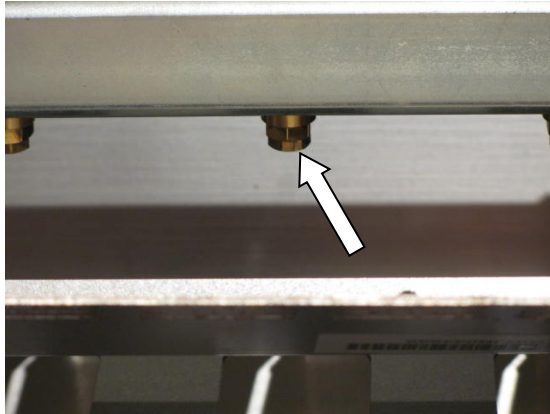

5. Change the SCB orifice tip.

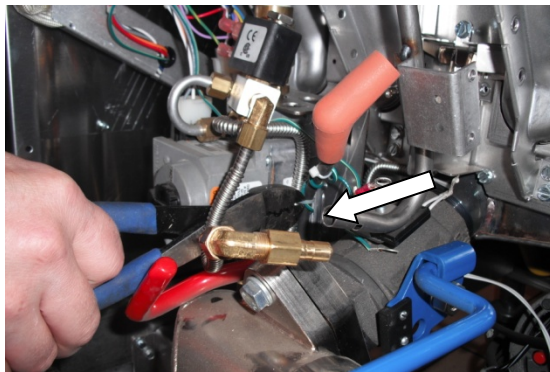

6. Replace and adjust the gas valve regulator.

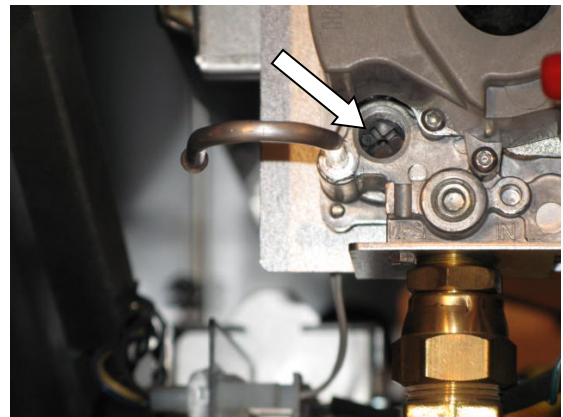
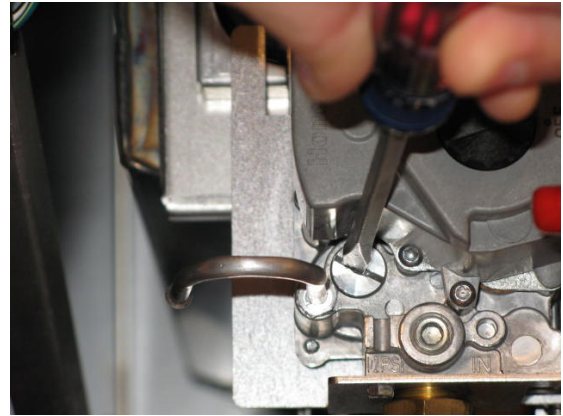

7. Adjust the burner manifold pressure. See section 26.2 “Taking a manifold gas pressure reading”.

Manifold Gas Pressure Table

NAT	LP
4.0” wc,(1.0 kPa) (10 mbar)	10” wc (2.5 kPa) (25 mbar)

8. Insert a flathead screwdriver into the cap and turn counter-clockwise to remove it.
9. Insert flathead screwdriver into the cap and turn counter-clockwise to increase the gas pressure or clockwise to decrease the gas pressure.
10. Place a sticker on the door indicating the unit has been converted.

⚠ DANGER ⚠

Check for gas leaks after installation or servicing of a gas fryer. Apply a leak detection solution to all connections and joints to ensure there are no bubbles or leaks. Failure to check for and correct any leaks could lead to fire and/or explosion, property damage, injury and death.

19 Replacing the Return Valve

⚠ WARNING ⚠

DO NOT remove fry vat or drain fittings before all oil is drained from the tank. Serious injury will result from slipping, falling or contact with hot liquids causing property damage, injurious severe burns and/or death.

1. Remove all connections from the 3-way return valve using a 1/16 inch wrench.

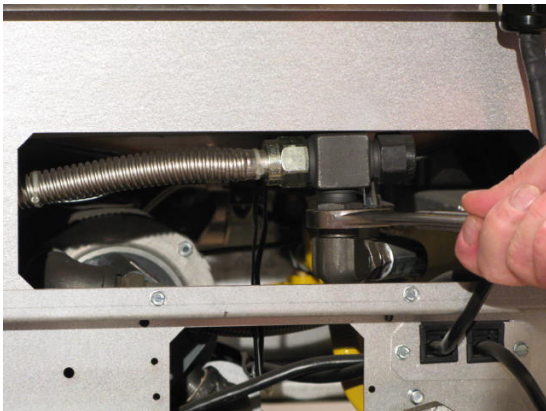
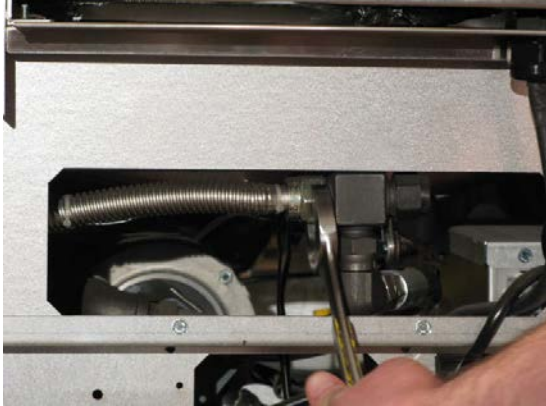

2. Remove the cotter pin on return valve using needle-nose pliers.



3. Replace the return valve by following steps 1 through 2 in reverse, replacing the cotter pin if necessary.

NOTE

Thread sealant is not required for these fittings.

20 Replacing the Optional Flush Hose Assembly and Valve

⚠ DANGER ⚠

Prior to moving, testing, maintaining or repairing your appliance, ensure it is emptied of all oil, cool, disconnected from gas and all electrical power. Failure to do so may result in property damage, damage to your fryer, injury or death.

1. Remove the lower connection at the 3-way return valve in the back of the unit using a 15/16 inch wrench.



2. Remove the male quick disconnect using a 15/16 inch wrench.

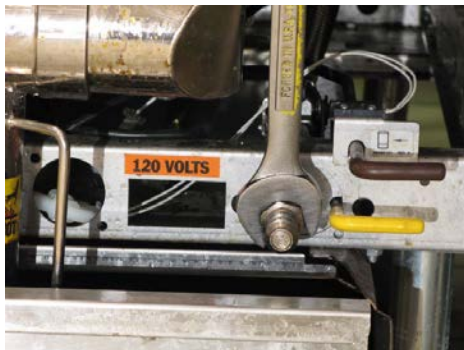

3. Unplug the proximity switch.

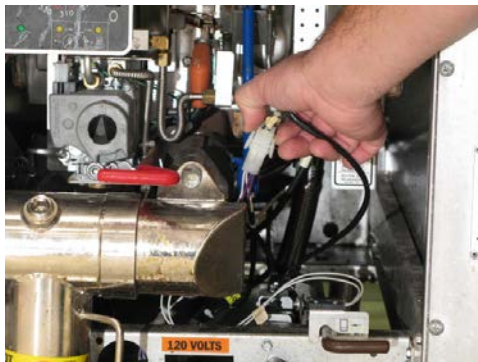

4. Remove two (2) screws holding the flush hose assembly using a 5/16 socket.

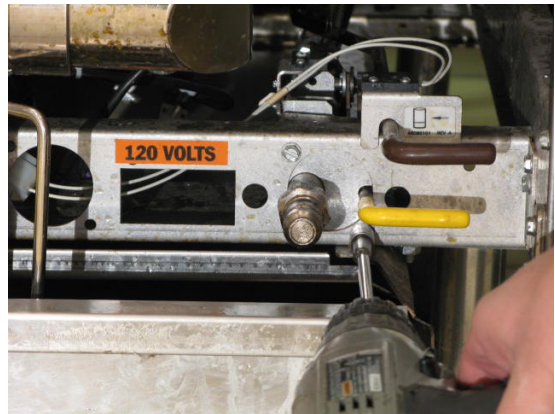

5. Remove the flush hose assembly.

6. Remove the four (4) screws from the magnets using a flathead screwdriver.

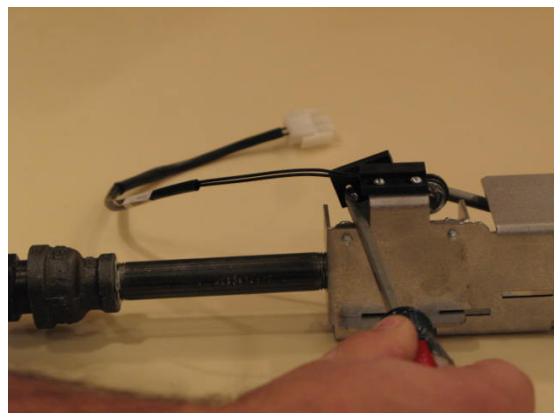
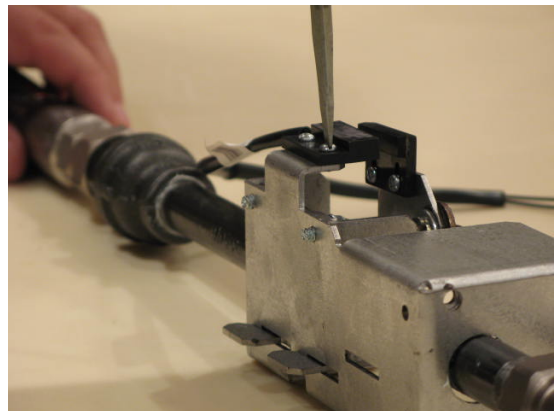

7. Remove the two (2) screws from the valve mounting brackets using a 5/16 socket.

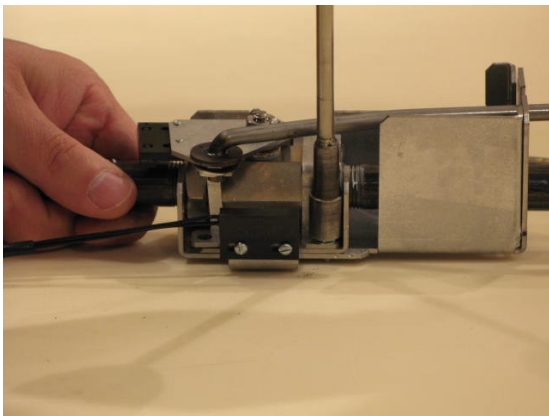
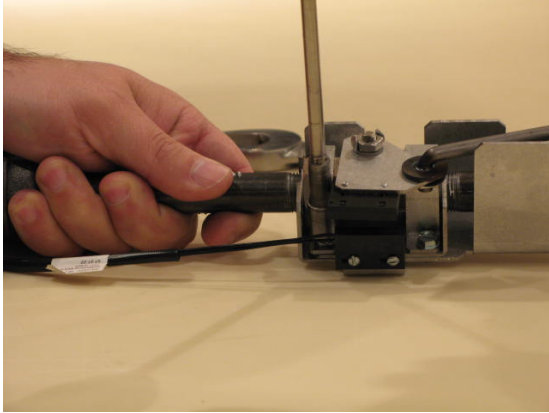

8. Slide the bracket to the back of the assembly.

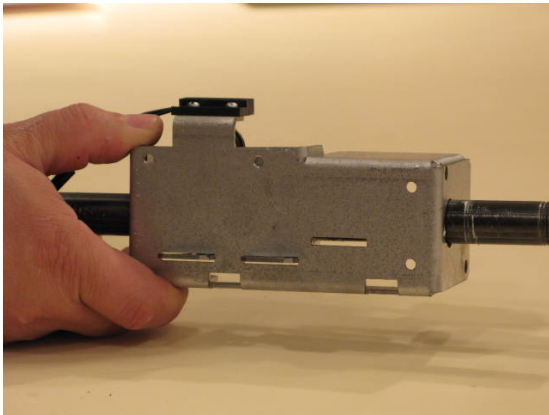

9. Lift bracket out and slide forward.

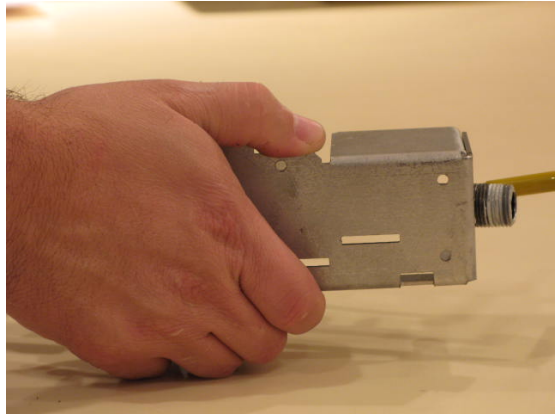

10. Bend down tabs of the stem nut washer using a needle-nose plier.

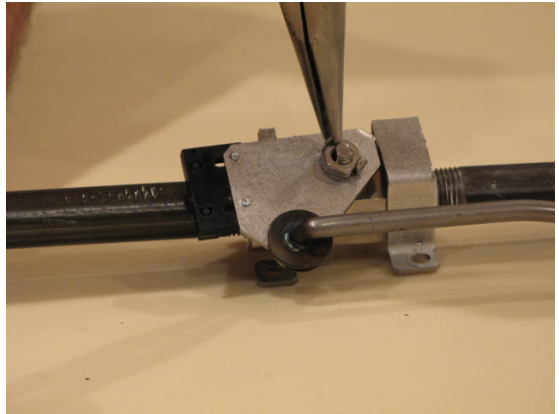

11. Remove the nut using a 7/16 inch wrench.

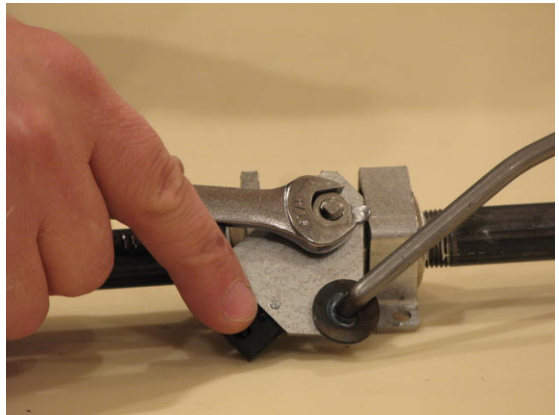

12. Remove the handle.

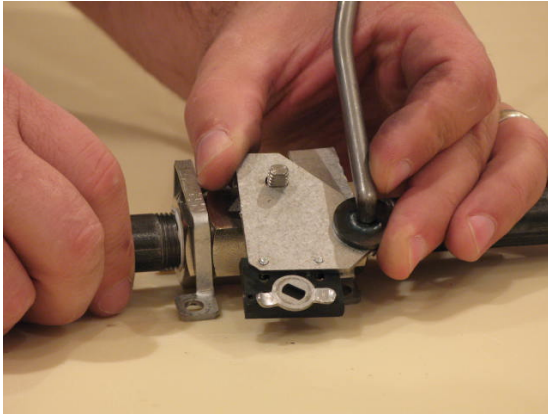

13. Remove the mounting bracket.

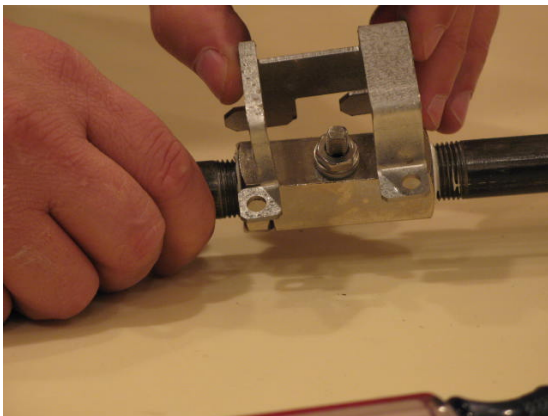

14. Remove the piping using a 15/16 inch wrench on the valve and an adjustable wrench on the piping.



15. Replace the flush hose assembly and valve by following steps 1 through 14 in reverse.

21 Replacing the Waste Oil and Components

21.1 Removing Rear Mounting Bracket

1. Remove six (6) screws using a 5/16 socket wrench.

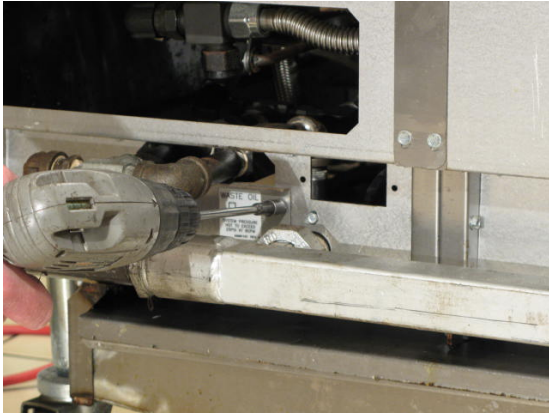

3. Remove two (2) screws with a 5/16 socket wrench.

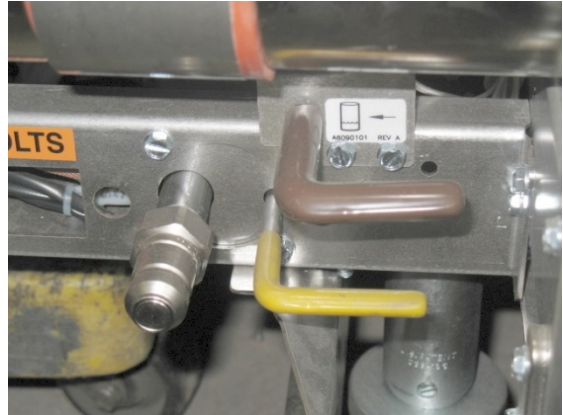

⚠ DANGER ⚠

Prior to moving, testing, maintaining or repairing your appliance, ensure it is emptied of all oil, cool, disconnected from gas and all electrical power. Failure to do so may result in property damage, damage to your fryer, injury or death.

2. Disconnect from the filter return line using a 1-1/16 inch wrench.

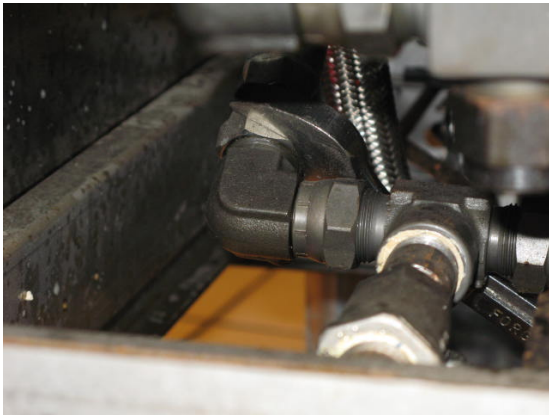

21.2 Removing the Check Valve

1. Remove the 3/8 inch nipple using an adjustable wrench.

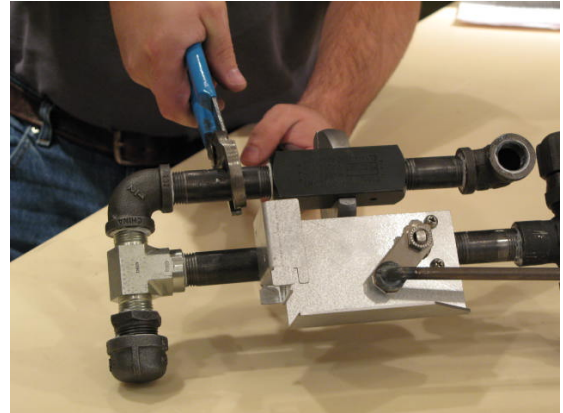
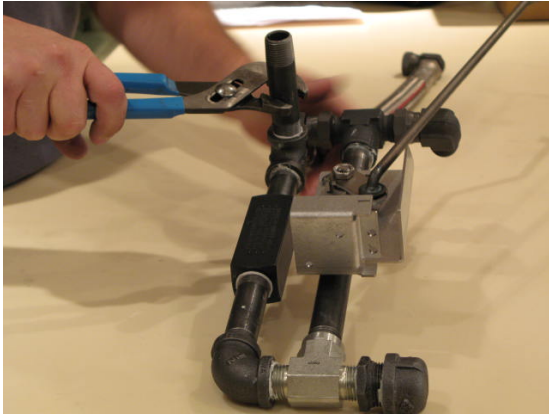

2. Remove the second nipple using two adjustable wrenches.

3. Remove the valve nut using a 9/16 inch open-ended wrench.



4. Remove the valve lever.

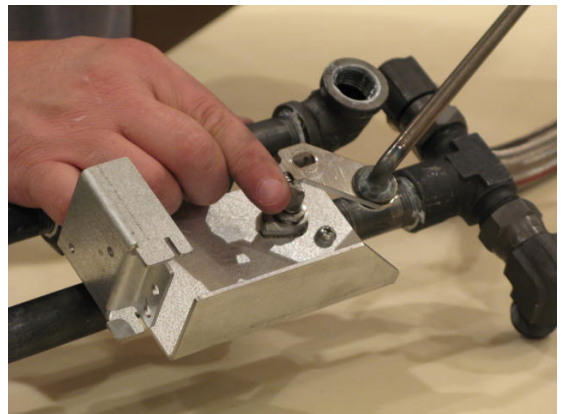
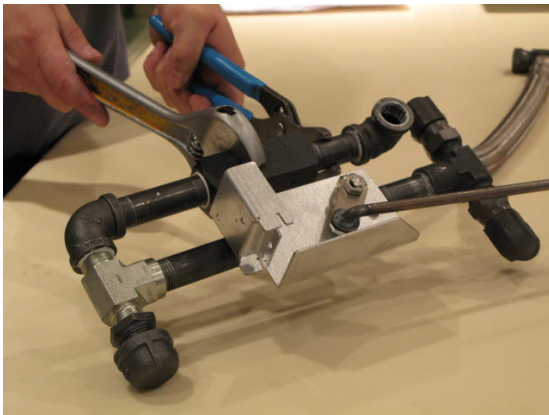

5. Remove the two (2) screws using a Phillips screwdriver.

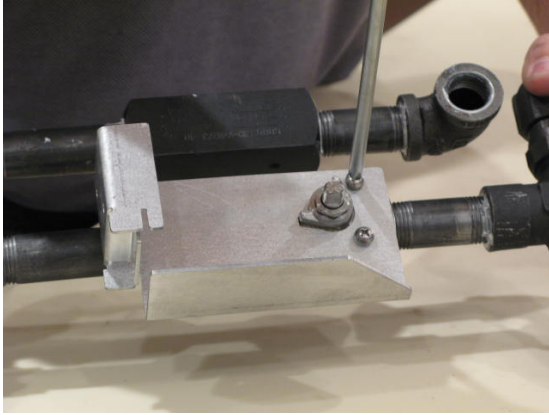

6. Lift off the mounting bracket.



7. Remove the valve using two adjustable wrenches.

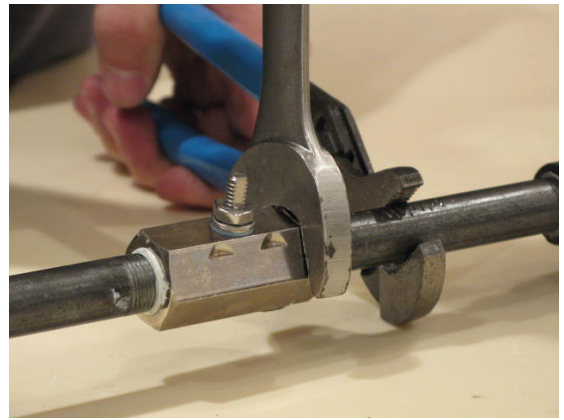

8. Follow steps 1 through 7 in reverse to reinstall.

22 Removing the Filter Pump from the Motor

1. Remove the two (2) bolts holding the filter pump head to the motor using a 1/2 inch open-ended wrench.



2. Remove the filter pump head from the motor.

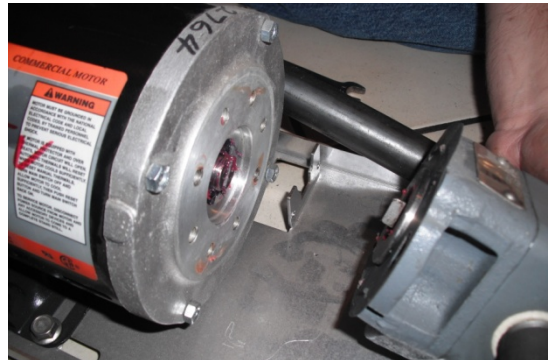

3. Reinstall the filter pump head to the motor by following steps 1 through 2 in reverse.

22.1 Replacing Seal Kit

1. Remove the four (4) bolts on filter pump using 7/16 inch open-ended wrench.



2. Remove the filter pump head.

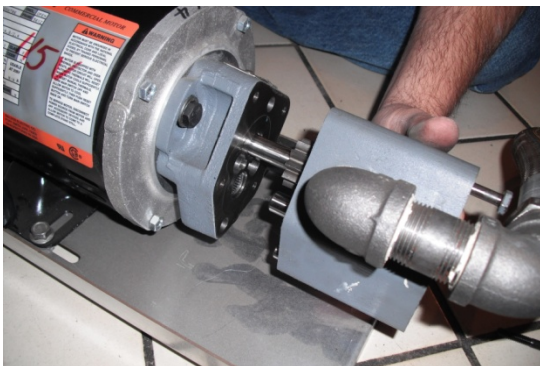

3. Replace the seal.

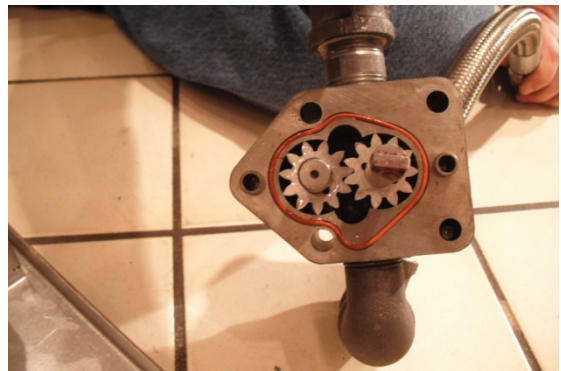

4. Reinstall the filter pump head to the motor by following steps 1 through 3 in reverse.

23 Replacing the Drain Line or Gasket

1. Remove one (1) screw on the drain line using a 7/16 inch wrench.



2. Lift off the drain manifold clamp.

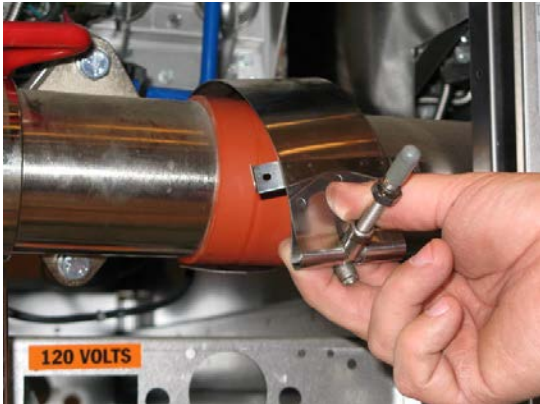

3. Slide off the drain manifold gasket.

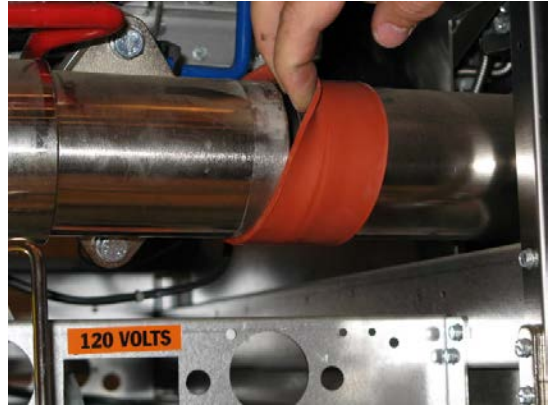

4. Slide out the drain line.

5. Reinstall the new drain line by following steps 1 through 4 in reverse to.

⚠ DANGER ⚠

Any and all spilled oil, water or other liquids that occurs as a result of operation, cleaning, maintenance or repair of this fryer should immediately be cleaned and dried. Failure to do so can create a slippery surface resulting in falling/impact injury or death.

24 Replacing the Pump Relay and Circuit Breaker

24.1 Replacing the Circuit Breaker

1. Disconnect the connections and power supply cords from the filter pump.

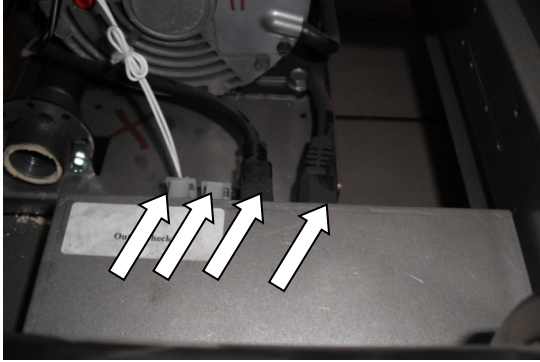

2. Remove the pump box.



3. Remove the circuit breaker from the pump box.



4. Remove all wires on the circuit breaker using needle-nose pliers.



5. Squeeze the tabs on the circuit breaker and push it out.

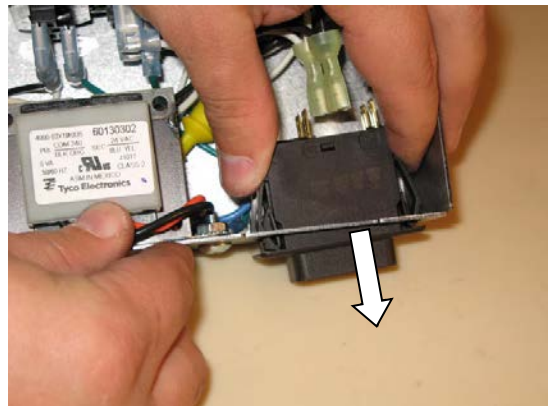

6. Reinstall the new circuit breaker by following steps 1 through 5 in reverse.

24.2 Replacing the Pump Relay

1. Remove the two (2) screws, which hold the pump relay, using a Phillips screwdriver.



2. Remove all wires on the pump relay using needle-nose pliers. See “Simplified Wiring Diagrams section 35.7”.

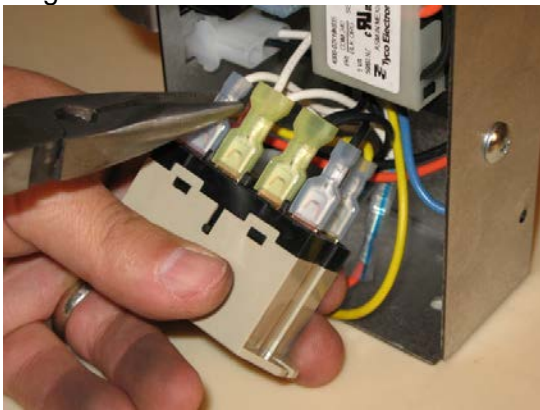

3. Remove the pump relay.

4. Reinstall the new pump relay by following steps 1 through 2 in reverse.

25 Cleaning the Gas Valve Vent Tube

⚠ DANGER ⚠

Prior to moving, testing, maintaining or repairing your appliance, ensure it is emptied of all oil, cool, disconnected from gas and all electrical power. Failure to do so may result in property damage, damage to your fryer, injury or death.

1. Bend the gas valve vent tube to allow for removal.



2. Loosen nut at the base of the vent tube with a 3/8 inch open-ended wrench and then remove.

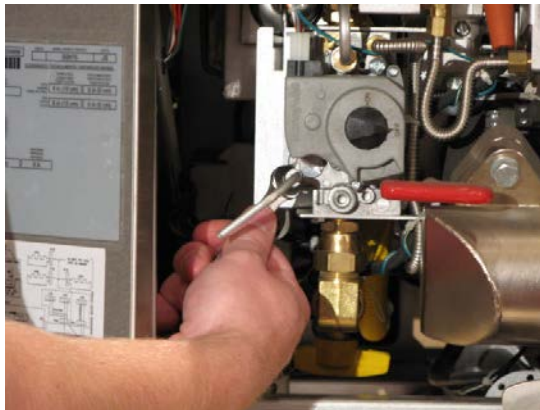

3. Clean the tube (not shown) and reinstall.

NOTE

Insure the vent tube is not reinstalled in an upright position and insure there are no kinks in the tube.

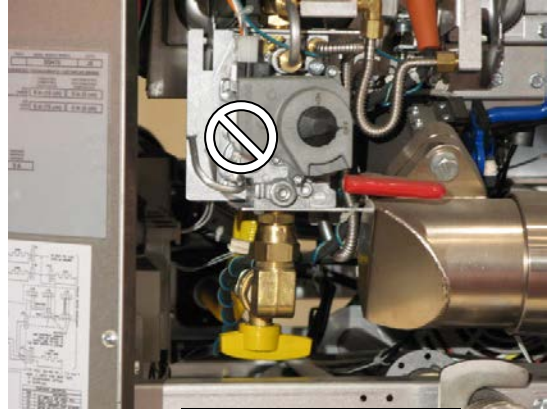

⚠ DANGER ⚠

Check for gas leaks after installation or servicing of a gas fryer. Apply a leak detection solution to all connections and joints to ensure there are no bubbles or leaks. Failure to check for and correct any leaks could lead to fire and/or explosion, property damage, injury and death.

26 Checking the Gas Pressure

26.1 Taking a Supply Gas Pressure Reading

1. Turn off gas.
2. Unscrew and remove the gas supply plug with a 3/16 inch hex wrench.

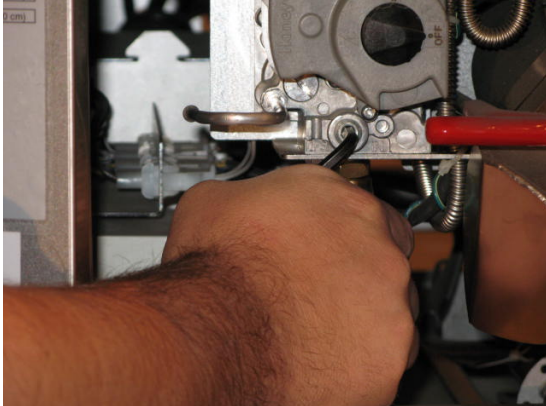

3. Finger tighten the test fitting into the test port.

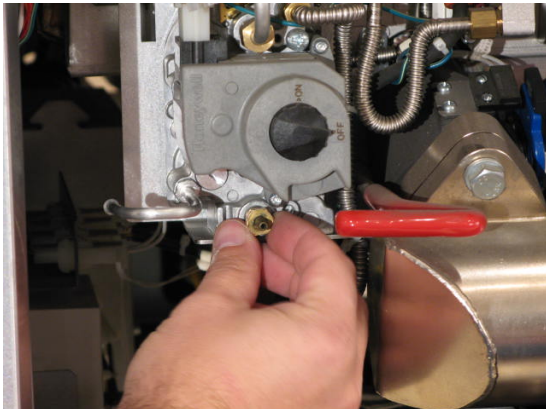

4. Finish tightening the test fitting using a 7/16 inch open-ended wrench.

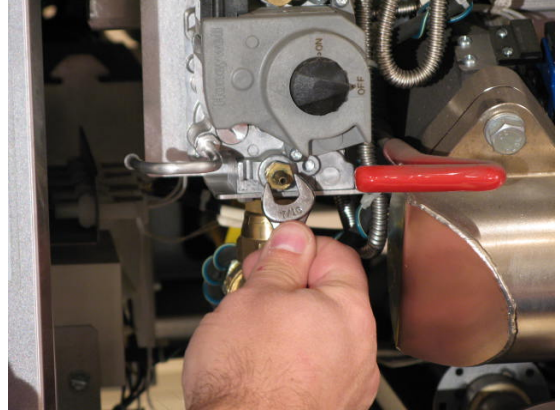

5. Connect the manometer.

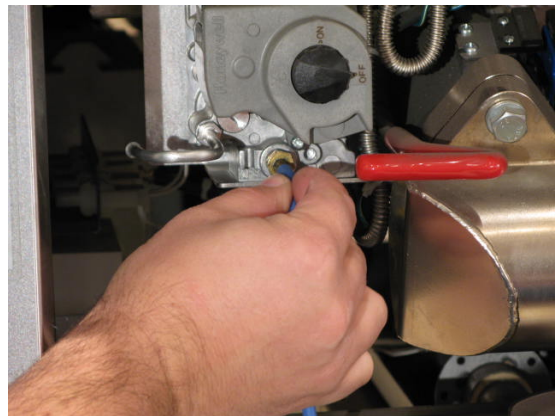

6. Turn on the main gas supply line.

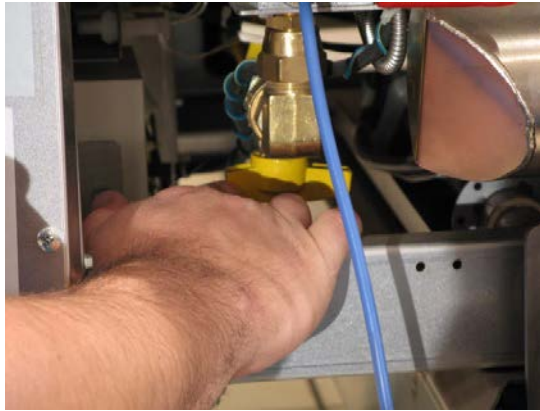

7. Check the supply gas pressure with the manometer and compare the reading to the supply gas pressure table to determine what the incoming gas pressure should be.

Supply Pressure Table (Need to check incoming pressure both Static and Dynamic)

NAT	LP
7" wc (1.7 kPa) (17.4 mbar)	11" wc (2.7 kPa) (27.4 mbar)
8" wc (2.0 kPa) (20. Mbar)	12" wc (3.0 kPa) (30.0 mbar)
9" wc (2.24 kPa) (22.4 mbar)	13" wc (3.24 kPa) (32.4 mbar)

NOTE

You cannot adjust the supply gas pressure at the unit. Anything over/under the recommended amount should be adjusted at the facility's main gas line.

- 8. Shut off the main gas supply line.
- 9. Disconnect the manometer.
- 10. Remove the test fitting.

11. Apply Fluoropolymer paste to gas supply plug.

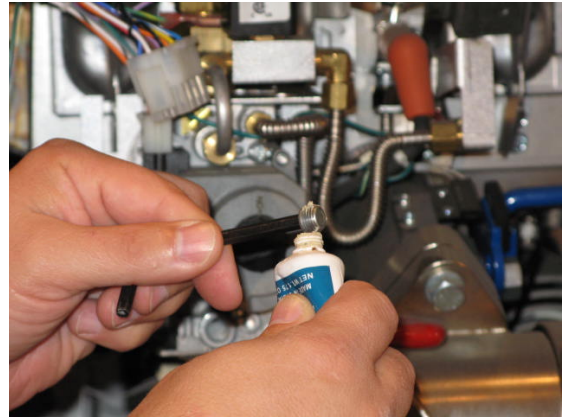

12. Reinstall gas supply plug with a 3/16 inch hex wrench.

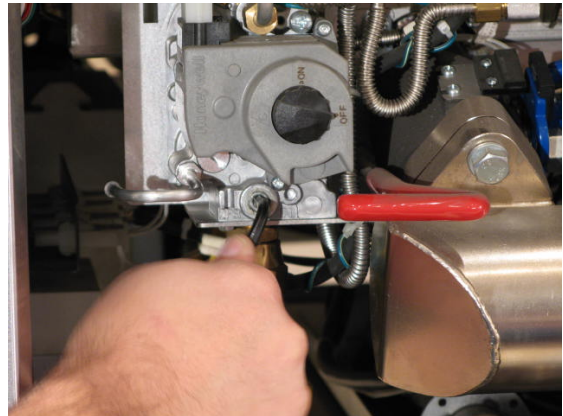

13. Turn on the main gas supply line.

⚠ DANGER ⚠

Check for gas leaks after installation or servicing of a gas fryer. Apply a leak detection solution to all connections and joints to ensure there are no bubbles or leaks. Failure to check for and correct any leaks could lead to fire and/or explosion, property damage, injury and death.

26.2 Taking a Manifold Gas Pressure Reading

1. Turn off main gas.
2. Unscrew and remove the gas manifold plug with a 3/16 inch hex wrench.

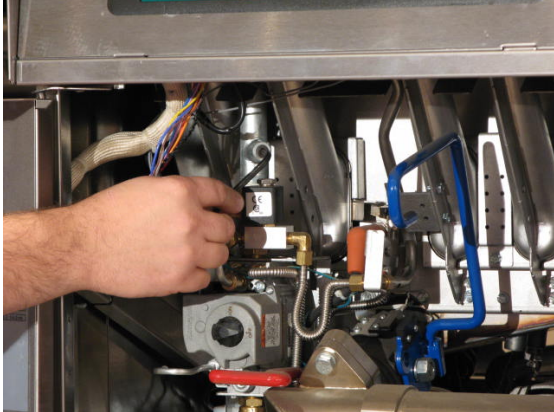

3. Finger tighten the test fitting into the test port.



4. Finish tightening the test fitting using a 7/16 inch open-ended wrench.

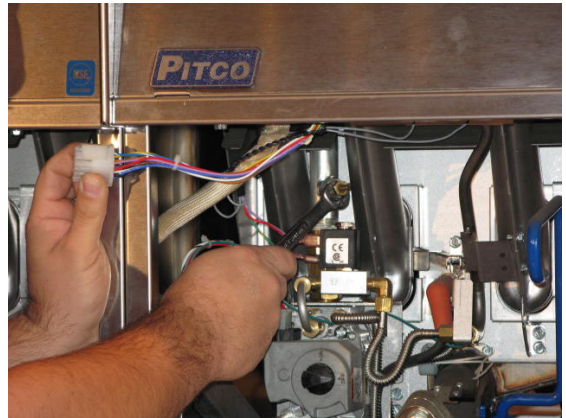

5. Connect the manometer.



6. Turn on the main gas.

⚠ DANGER ⚠

Check for gas leaks after installation or servicing of a gas fryer. Apply a leak detection solution to all connections and joints to ensure there are no bubbles or leaks. Failure to check for and correct any leaks could lead to fire and/or explosion, property damage, injury and death.

26.3 Adjusting Manifold Gas Pressure

1. Check the manifold gas pressure with the manometer and compare the reading to the manifold gas pressure table.

Manifold Gas Pressure Table

NAT	LP
4.0" wc (1.0 kPa) (10.0 mbar)	10" wc (2.5 kPa) (25 mbar)

2. Insert a flathead screwdriver into the cap and turn counter-clockwise to remove it.

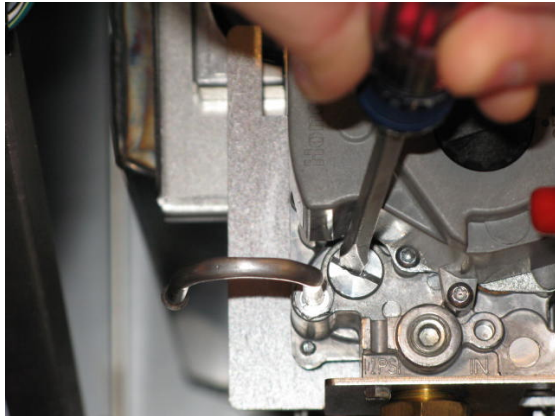

3. Insert flathead screwdriver into the cap and turn counter-clockwise to increase the gas pressure or clockwise to decrease the gas pressure.

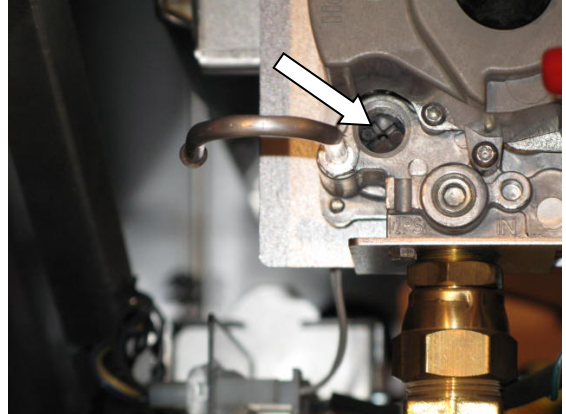

4. When adjustment is complete:

- a. Turn off the gas supply line.
- b. Disconnect the manometer.
- c. Remove the test fitting.
- d. Reinstall the gas manifold plug.
- e. Reconnect solid state thermostat.
- g. Turn on gas supply line.

⚠ DANGER ⚠

Check for gas leaks after installation or servicing of a gas fryer. Apply a leak detection solution to all connections and joints to ensure there are no bubbles or leaks. Failure to check for and correct any leaks could lead to fire and/or explosion, property damage, injury and death.

26.4 Adjusting Pilot Flame

1. Remove pilot adjustment cap with Philips screwdriver.

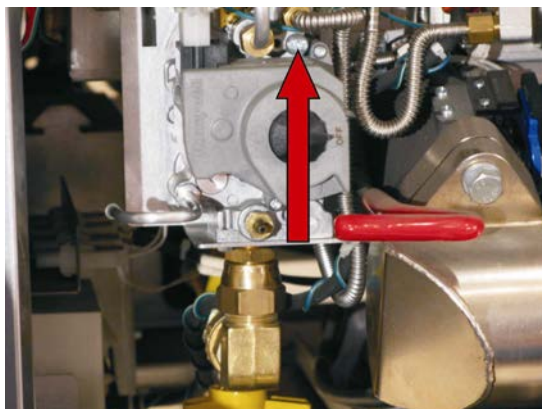

2. Rotate adjuster clockwise to decrease and counter-clockwise to increase pilot flame.

3. Replace adjustment cap.

27 Replacing the Self-Cleaning Burner Solenoid

⚠ DANGER ⚠

Prior to moving, testing, maintaining or repairing your appliance, ensure it is emptied of all oil, cool, disconnected from gas and all electrical power. Failure to do so may result in property damage, damage to your fryer, injury or death.

1. Remove the SCB flex tube fitting using a ½ inch open-ended wrench.

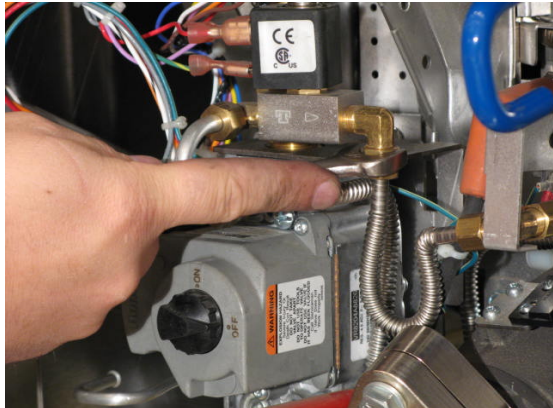

2. Remove the SCB valve inlet fitting using a ½ inch open-ended wrench.

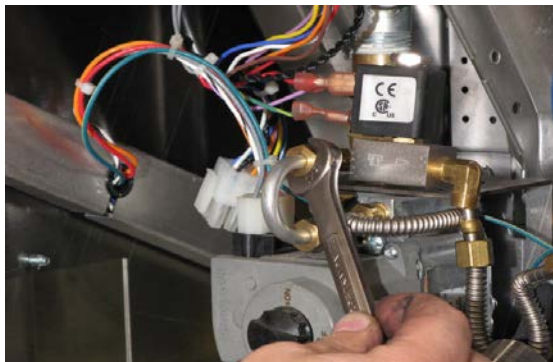

3. Disconnect the terminals using needle-nose pliers.



4. Remove the two (2) elbows using a ½ inch open-ended wrench.



5. Follow steps 1 through 4 in reverse to reinstall SCB valve.

⚠ DANGER ⚠

Check for gas leaks after installation or servicing of a gas fryer. Apply a leak detection solution to all connections and joints to ensure there are no bubbles or leaks. Failure to check for and correct any leaks could lead to fire and/or explosion, property damage, injury and death.

28 Replacing the Gas Valve

NOTE

Prior to moving, testing, maintaining or repairing your appliance, ensure it is emptied of all oil, cool, disconnected from gas and all electrical power. Failure to do so may result in property damage, damage to your fryer, injury or death.

1. Remove the pilot tubing from the gas valve using a 7/16 inch open-ended wrench.

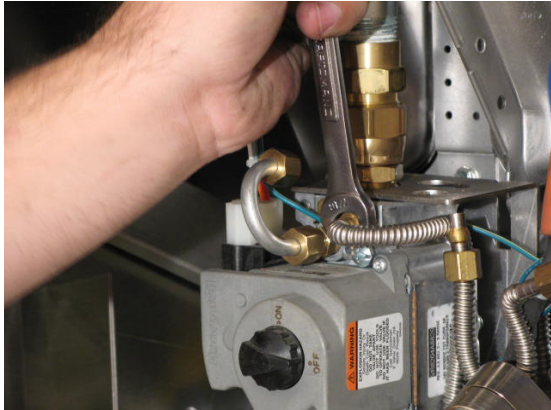

2. Disconnect the wiring connection from gas valve.



3. Holding the elbow with a wrench, remove the swivel nut on the bottom gas valve fitting using a 1-1/16 inch open-ended wrench.



4. Holding the elbow with a 7/8" wrench, remove the swivel nut on the top gas valve fitting using a 15/16 inch open-ended wrench.



5. Remove the gas valve.

29 Replacing the DVI Switch (Manual Filter Only)

NOTE

Photos are for illustrative purposes only and may not be an exact match to your appliance..

3. Replace the DVI switch ensuring a 1/4 inch gap between the actuator and the magnet.
4. Follow steps 1 through 3 in reverse to reinstall a new DVI.

1. Remove the two (2) screws, which hold the proximity sensor on the drain handle, using a flathead screwdriver.

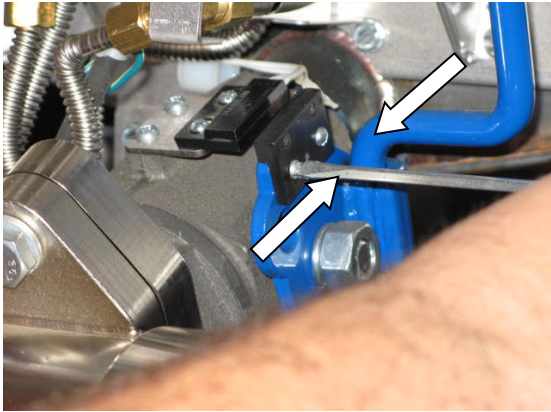

2. Remove the two (2) screws, which hold the actuator, using a flathead screwdriver.

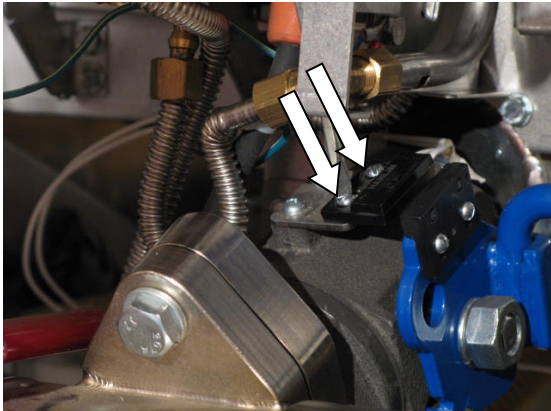

30 Replacing the Burner Assembly

30.1 Replacing the Burner(s)

NOTE

Gas valve can stay in place if replacing right side burners. Only needs to be removed for left side burners.

1. Drop the gas valve out of the way by holding the elbow with a 7/8 inch wrench and removing the swivel nut on the top gas valve fitting using a 15/16 inch open-ended wrench.



2. Remove the pilot assembly. See “Replacing an Igniter/Pilot Assembly” in Section 11.

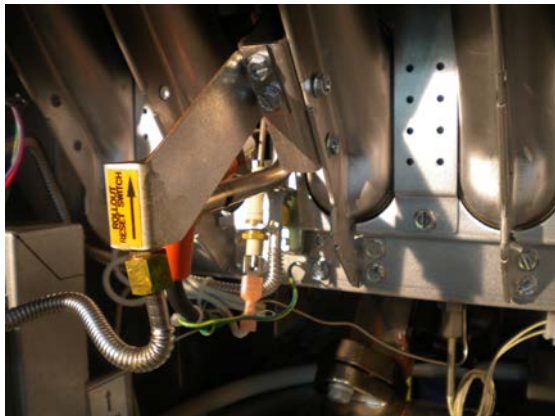

3. Remove the two (2) screws, which hold the rollout switch, using a 5/16 inch socket.

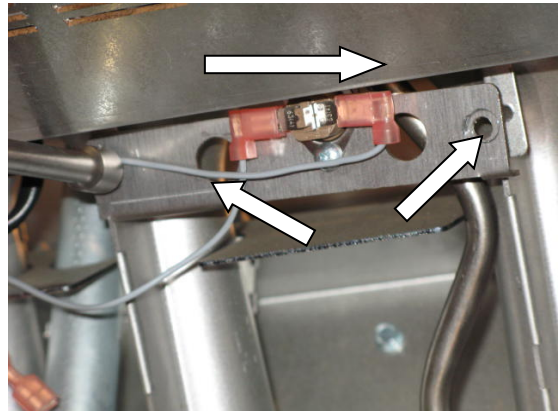

4. Remove the screws, which hold the flame jumper shields, using a 5/16 inch socket.

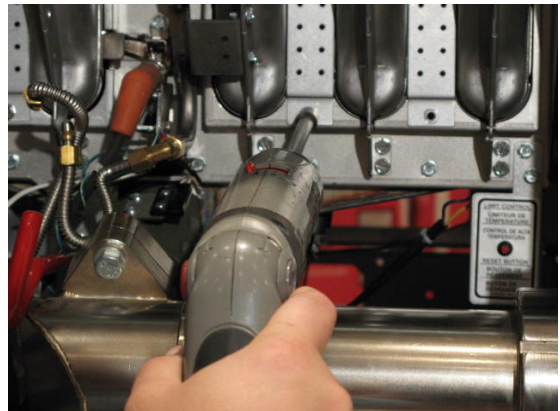

4. Remove all flame jumpers.

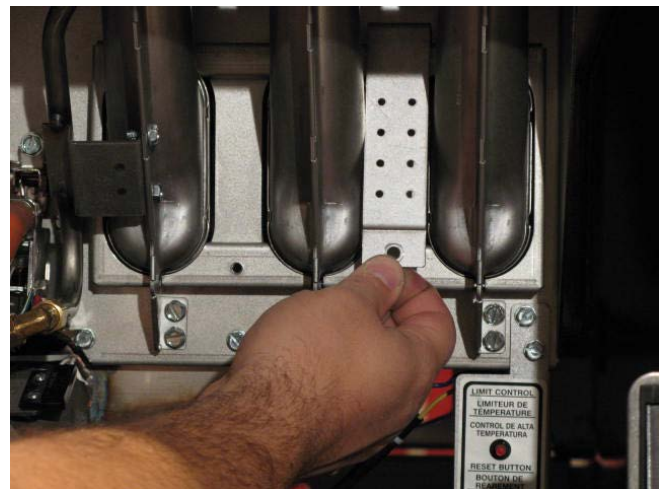

6. Remove the two (2) screws, which hold the SCB runner tube, using a 5/16 inch socket.

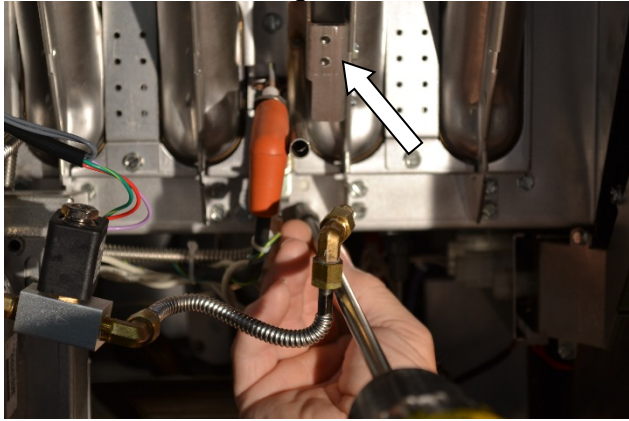

7. Remove the two (2) screws, which hold each burner, using a 5/16 inch socket.

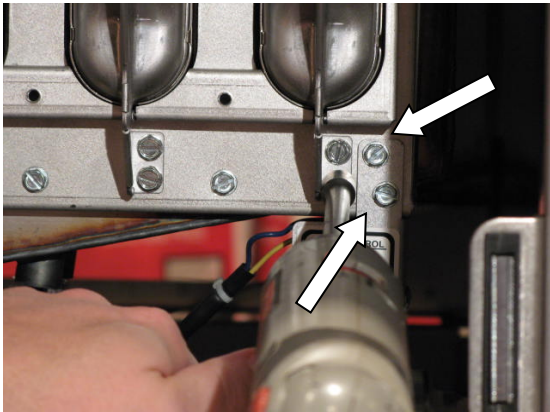

8. Remove the right burner(s) by sliding them off the SCB runner tube.

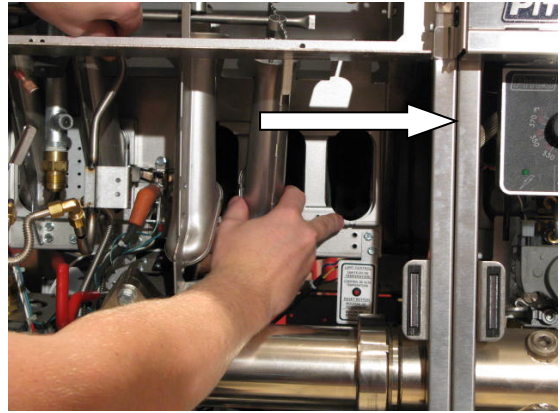

9. Remove the SCB runner tube.

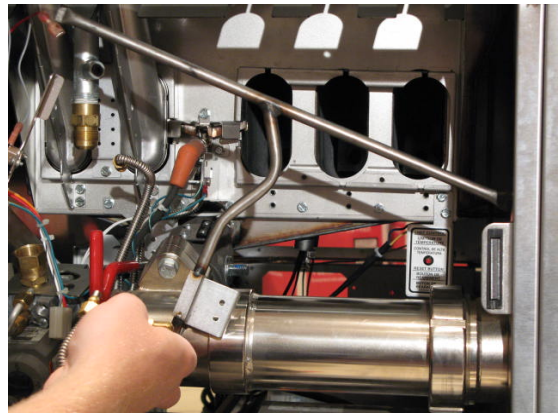

10. Remove the left burner(s) If you have already removed runner tube, just remove the left burners.

11. Reinstall the new burner(s) by following steps 1 through 12 in reverse.

⚠ DANGER ⚠

Check for gas leaks after installation or servicing of a gas fryer. Apply a leak detection solution to all connections and joints to ensure there are no bubbles or leaks. Failure to check for and correct any leaks could lead to fire and/or explosion, property damage, injury and death.

30.2 Replacing the Burner Assembly

See "Replacing the Burner(s)" in section 31.1.

1. Remove the burner shield.

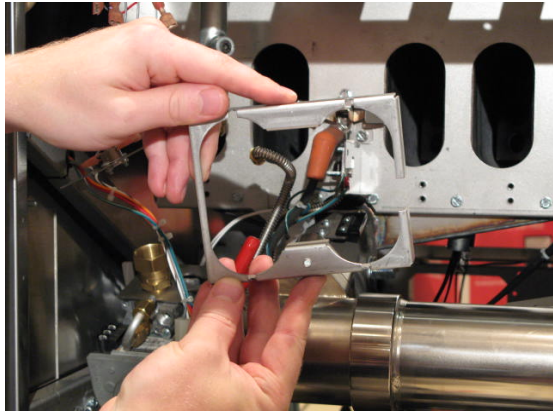

NOTE: When reinstalling, the burner shield opening should face toward the pilot.

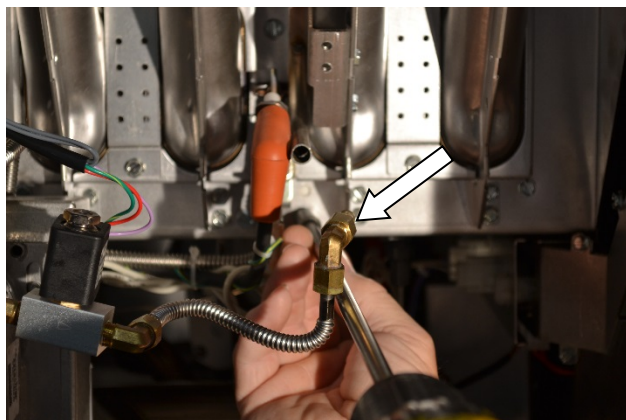

2. Remove the eight (8) screws (3 screws on the top and 2 in the middle and 3 screws on the bottom), which hold the burner rack, using a 5/16 inch socket.



3. Remove the burner rack by pulling it toward the front of the unit.



4. If necessary, replace the insulation on the back of the burner rack. (Please note insulation may vary from this picture depending on model)

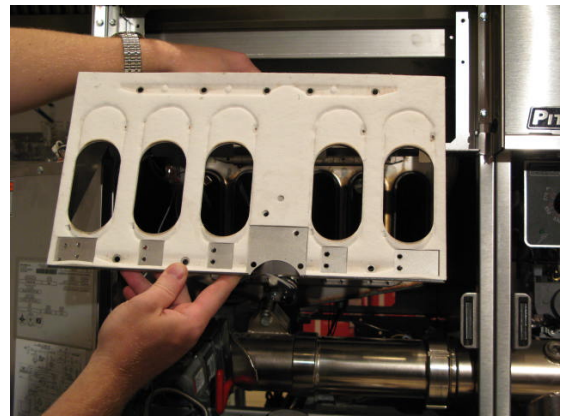

5. Reinstall a new burner assembly by following steps 1 through 5 in reverse.

⚠ DANGER ⚠

Check for gas leaks after installation or servicing of a gas fryer. Apply a leak detection solution to all connections and joints to ensure there are no bubbles or leaks. Failure to check for and correct any leaks could lead to fire and/or explosion, property damage, injury and death.

31 Replacing the Frypot

⚠ DANGER ⚠

Prior to moving, testing, maintaining or repairing your appliance, ensure it is emptied of all oil, cool, disconnected from gas and all electrical power. Failure to do so may result in property damage, damage to your fryer, injury or death.

1. Remove the controller front panel (see Section 5.1), gas valve (see Section 29), pilot assembly (see Section 11), and burner assembly (see Section 31.2).
2. Remove the baffle by pulling it out.

NOTE: For SSH models only.



3. Remove the drain manifold flange nut using a 9/16 inch close-ended wrench.

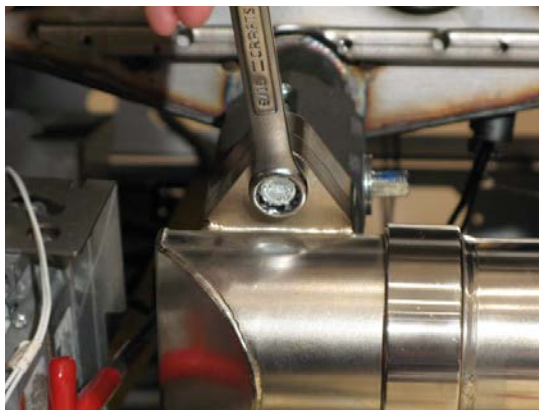

4. Loosen the collet using a spanner wrench.



5. Remove the collet.

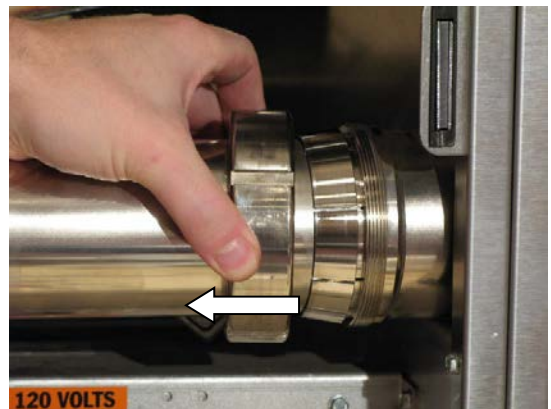

6. Slide piping away from flange.

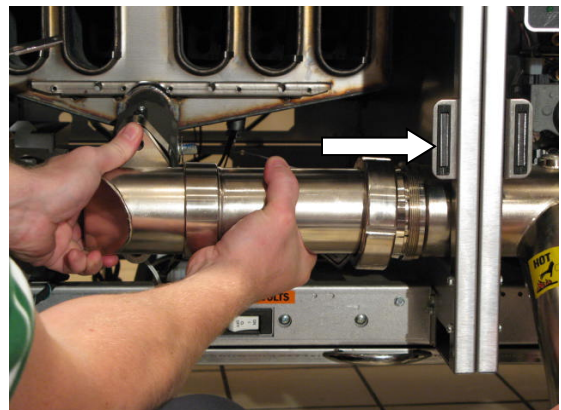

7. Remove the flange elbow.



⚠ DANGER ⚠

Any and all spilled oil, water or other liquids that occurs as a result of operation, cleaning, maintenance or repair of this fryer should immediately be cleaned and dried. Failure to do so can create a slippery surface resulting in falling/impact injury or death.

8. Remove the control box and wiring harness for each fryer that shares a common top deck.

9. Remove the four (4) screws per fryer, which hold the top deck down, using a 5/16 inch socket.

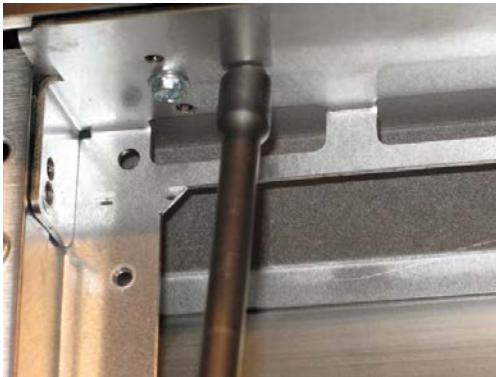

10. Remove the top deck by pulling up.



11. Remove the six (6) screws, which hold the back of the splash back, using a 5/16 inch socket.



12. Score the silicon sealer between the front of the splash backs using a flathead screwdriver or utility knife.



13. Remove the two (2) screws, which hold the front of the splash back, using a flathead screwdriver.



14. Remove the splash back by lifting up.



15. Remove the six (6) screws, which hold the tank to the cabinet, using a 5/16 inch socket.



16. Remove the channel strip by pulling up.



17. Score the silicon sealer between the tanks using a flathead screwdriver or utility knife.



18. Remove high-limit and temperature probes. See Replacing Ignition Module and Hi-limit Section 10.

19. Remove the two (2) screws, which hold the top deck support, using a 5/16 inch socket.

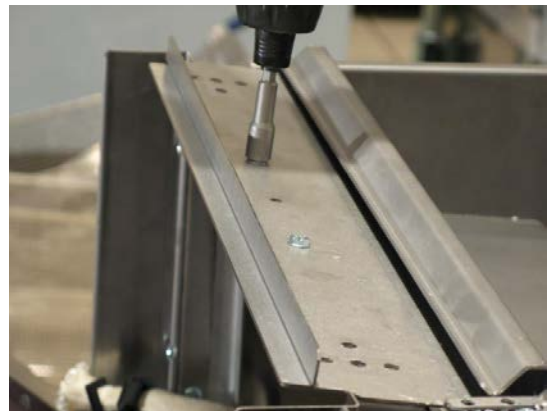

20. Lift up and pull out the tank.



NOTE: Lifting the tank requires two (2) technicians.

21. Set tank on floor.

22. Remove the drain line using a pipe wrench.



23. Remove the four (4) screws, which hold the flue, using a 5/16 inch socket and 3/8 inch close-ended wrench.



24. Remove the return valve using two adjustable wrenches.

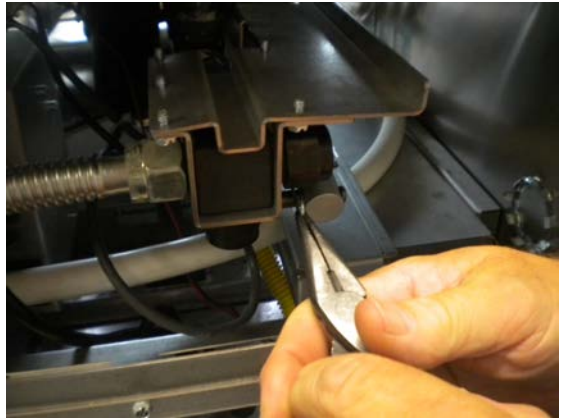

25. Remove actuator with needle nose pliers.



26. Remove filter piping with 1-1/16 inch wrench.

27. Follow steps 1 through 26 in reverse to reinstall a new frypot.

32 Replacing the Basket Lift Components

32.1 Removing the Basket Lift Cover

1. Remove the six (6) screws, which hold the back of the basket lift cover, using a 5/16 inch socket.



2. Lift up the back and remove.

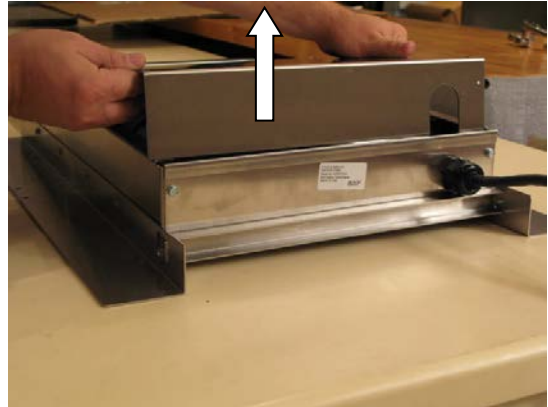

32.2 Replacing the Basket Lift Transformer

1. Remove the two (2) screws, which hold the transformer, using a 5/16 inch socket.



2. Remove all wires on transformer box using needle-nose pliers. See "Wiring Diagram – Basket Lifts" in Section 36.10.

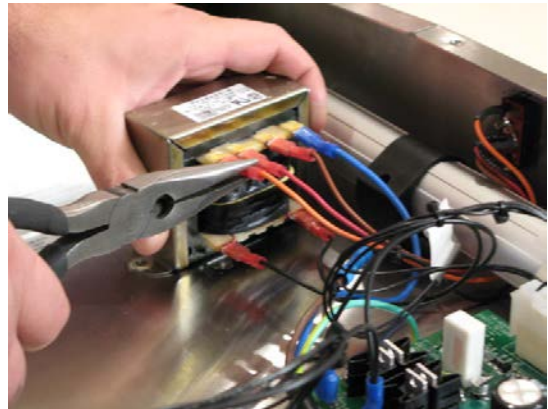

1. Follow steps 1 through 2 in reverse to reinstall new transformer box.

32.3 Replacing the Basket Lift Driver Board

1. Remove all wires on basket lift driver board using needle-nose pliers.

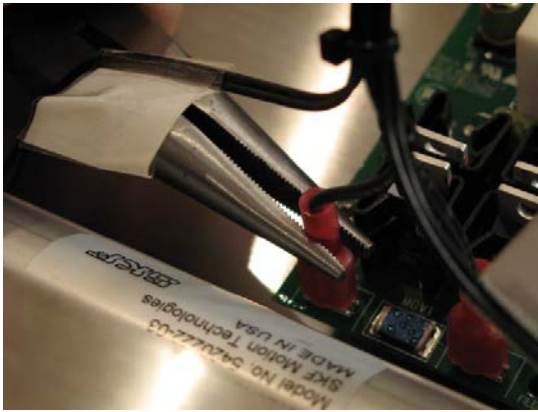

2. Remove the sensor connection using needle-nose pliers.

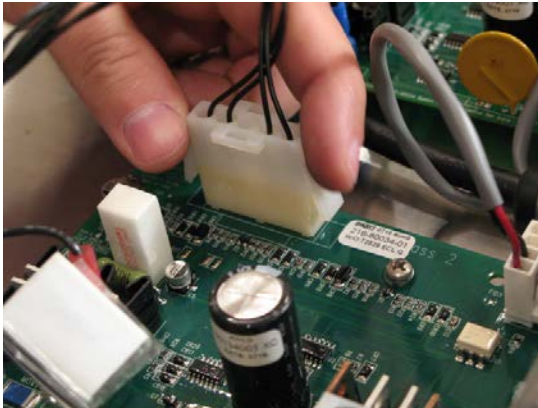

3. Remove the control signal connection using needle-nose pliers.

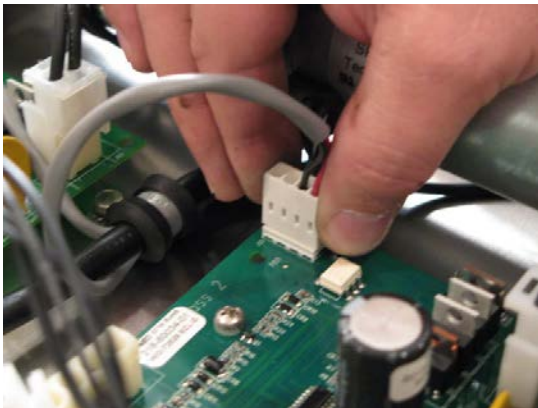

4. Remove the actuator power connection using needle-nose pliers.



5. Remove the four (4) screws, which hold the basket lift driver board, using a Phillips screwdriver.

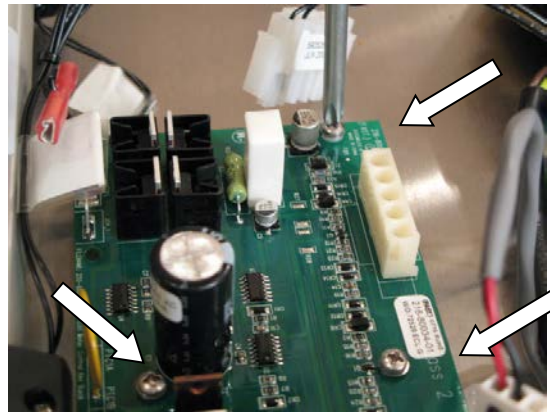

6. Follow steps 1 through 5 in reverse to reinstall a new basket lift driver board.

32.4 Adjusting the Magnetic Sensor

1. Make sure the sensor is approximately 3/4 inch from top of the motor to bottom of the sensor.

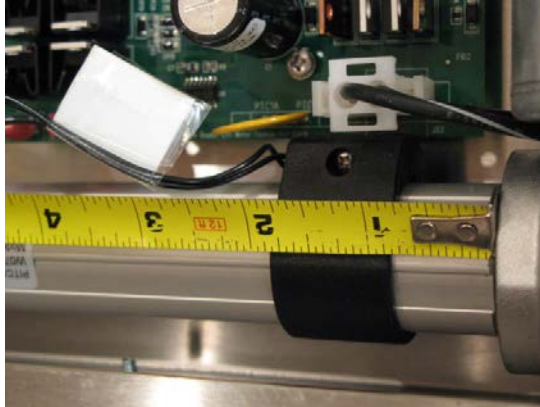

2. Make sure the sensor is approximately 7 3/4 inch from top of the motor to bottom of the sensor.



32.5 Replacing the Basket Lift Actuator

1. Cut all zip ties on the basket lift driver board.



2. Disconnect the transformer from the driver board. See "Wiring Diagram – Basket Lifts" in Section 36.10.

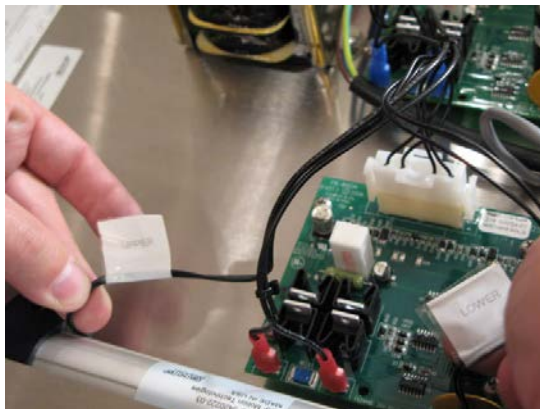

3. Disconnect the upper and lower limit connections on the basket lift driver board.

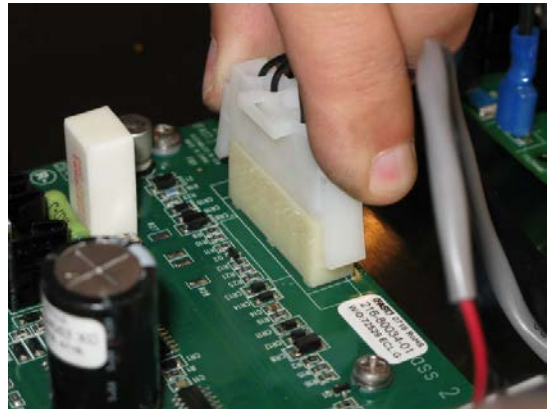

4. Remove the two (2) bolts, which hold the actuator, using a 3/16 inch Allen key.

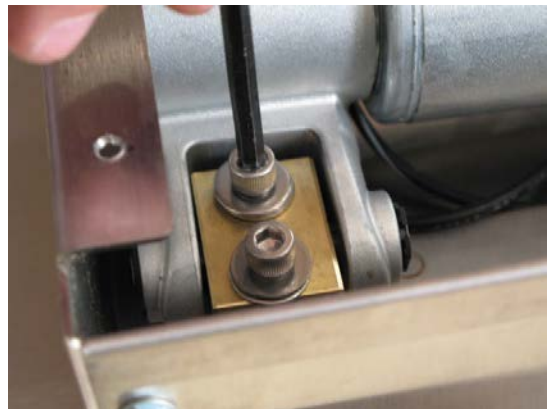

5. Remove the top retaining bushing by unscrewing.



6. Slide the bushing off the shaft.



7. Disconnect the motor connector from the driver board.

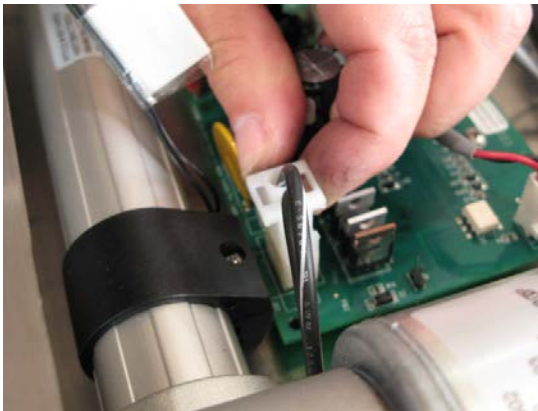

8. Rotate up the actuator collar.



9. Remove the actuator collar.



10. Follow steps 1 through 9 in reverse to reinstall a new basket lift actuator.

33 Replacing the Filter Pump and Motor

33.1 Removing the Filter Pump and Motor

NOTE

Photos are for illustrative purposes only and may not be an exact match to your appliance..

1. Remove filter pan and filter pan cover. Loosen the pump inlet tube using a crescent wrench.

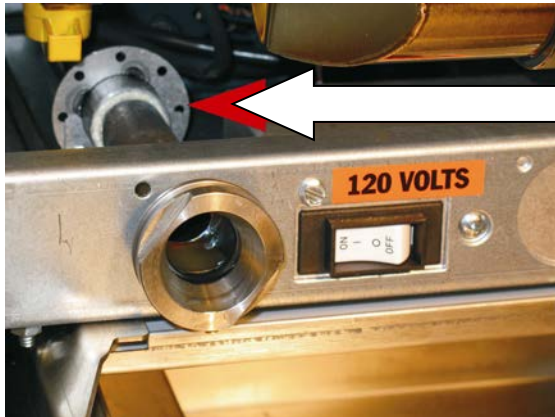

2. Unscrew and remove the inlet valve of the filter pump system.



⚠ DANGER ⚠

Any and all spilled oil, water or other liquids that occurs as a result of operation, cleaning, maintenance or repair of this fryer should immediately be cleaned and dried. Failure to do so can create a slippery surface resulting in falling/impact injury or death.

3. Pull out pump inlet tube.



4. Remove filter pan cover (not shown).

5. Disconnect the connections and power supply cords from the filter pump.

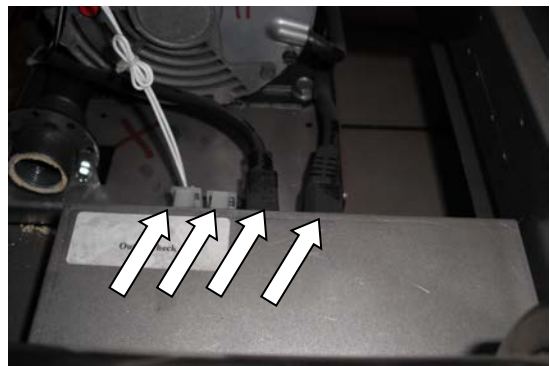

6. Remove the lower connection at the 3-way return valve using a 15/16 inch wrench.

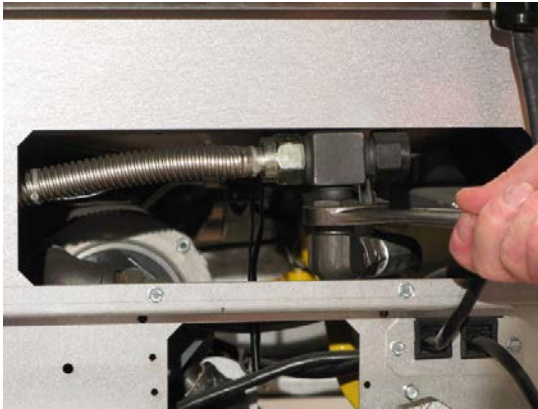

9. Remove the rear hair pin on the actuator.



7. Using a 1" inch wrench remove the JIB hose.

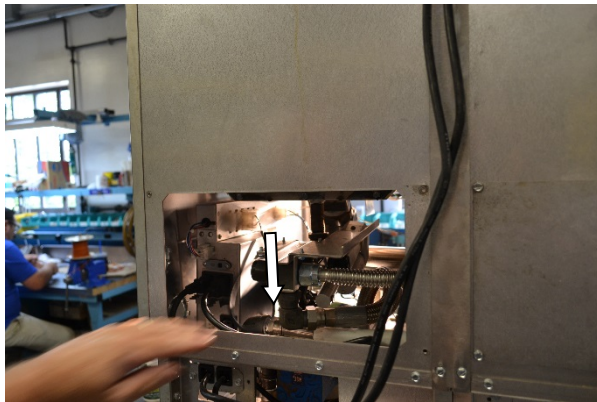

10. Remove the bracket.

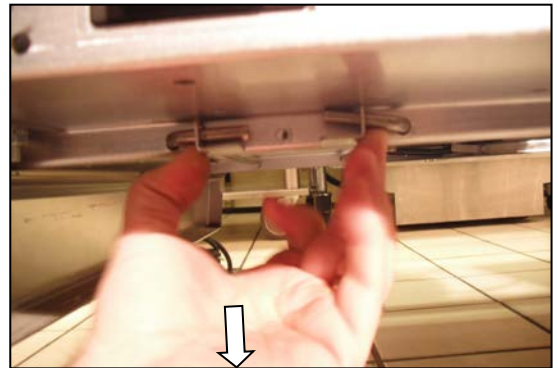

8. Remove one (1) screw, which holds a bracket which is underneath the ON/OFF breaker switch using a 5/16 inch socket.



NOTE

The filter pump will fall to the floor once the pins are pulled out. It is recommended that you brace the pump and motor before pulling out the pins.

11. Turn down the pins and then pull them out.

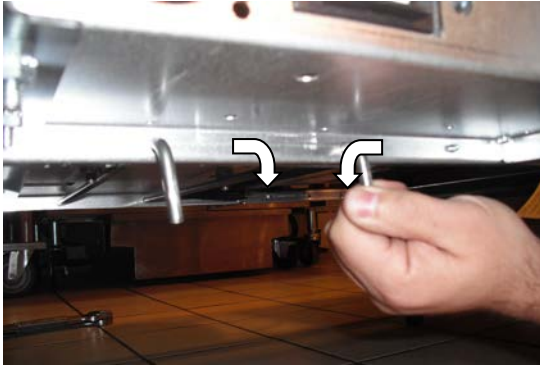

12. ROV units with a solofilter, will require the removal of the RH pan guide rail to allow the pump to be lowered as shown (Filter pan rails are not shown). Lower the filter pump to the floor and then pull it out.



13. Remove the three (3) bolts on the bottom of the filter pump base using a 1/2 inch open-ended wrench.



14. Remove two (2) screws on back of filter pump using a 5/16 inch socket.

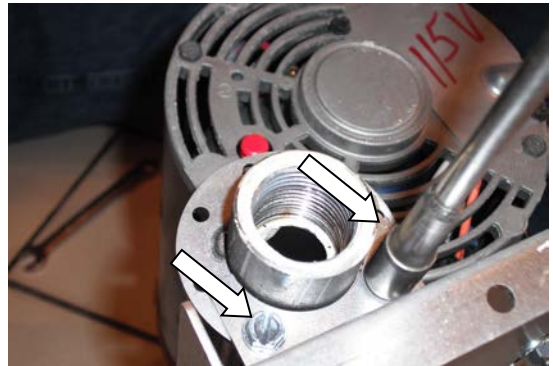

15. Remove existing piping from old filter pump using two adjustable wrenches.



16. Reinstall a new filter pump by following steps 1 through 13 in reverse.

34 Information Charts/Tables



34.1 Temperature Probe Resistance Chart

Probe Resistance in 5°F Increments.								
Probe Temp (°F)	Probe Temp (°C)	Resistance (Ohms)	Probe Temp (°F)	Probe Temp (°C)	Resistance (Ohms)	Probe Temp (°F)	Probe Temp (°C)	Resistance (Ohms)
10	-12.2	562734	175	79.4	11719	340	171.1	1058.23
15	-9.4	483875	180	82.2	10716	345	173.9	998.09
20	-6.7	417167	185	85.0	9812	350	176.7	942.00
25	-3.9	360589	190	87.8	8995	355	179.4	889.67
30	-1.1	312474	195	90.6	8255	360	182.2	840.78
35	1.7	271446	200	93.3	7586	365	185.0	795.10
40	4.4	236370	205	96.1	6979	370	187.8	752.38
45	7.2	206311	210	98.9	6427	375	190.6	712.41
50	10.0	180491	215	101.7	5926	380	193.3	674.95
55	12.8	158252	220	104.4	5470	385	196.1	639.87
60	15.6	139055	225	107.2	5055	390	198.9	606.96
65	18.3	122489	230	110.0	4675	395	201.7	576.09
70	21.1	108051	235	112.8	4329	400	204.4	547.09
75	23.9	95539	240	115.6	4013	405	207.2	519.86
80	26.7	84644	245	118.3	3723	410	210.0	494.24
85	29.4	75136	250	121.1	3458	415	212.8	470.16
90	32.2	66823	255	123.9	3214	420	215.6	447.49
95	35.0	59540	260	126.7	2991	425	218.3	426.13
100	37.8	53146	265	129.4	2785	430	221.1	406.02
105	40.6	47523	270	132.2	2597	435	223.9	387.04
110	43.3	42569	275	135.0	2422	440	226.7	369.14
115	46.1	38195	280	137.8	2262	445	229.4	352.24
120	48.9	34328	285	140.6	2113.9	450	232.2	336.29
125	51.7	30902	290	143.3	1977.3	455	235.0	321.21
130	54.4	27862	295	146.1	1851.0	460	237.8	306.94
135	57.2	25161	300	148.9	1734.3	465	240.6	293.46
140	60.0	22755	305	151.7	1626.1	470	243.3	280.69
145	62.8	20610	310	154.4	1525.9	475	246.1	268.61
150	65.6	18695	315	157.2	1433.0	480	248.9	257.15
155	68.3	16981	320	160.0	1346.7	485	251.7	246.30
160	71.1	15446	325	162.8	1266.6	490	254.4	236.00
165	73.9	14069	330	165.6	1192.1	495	257.2	226.24
170	76.7	12823	335	168.3	1122.8	500	260.0	216.96

NOTE: Resistance, of either probe lead, to the frame of the appliance should read as “open’ on the meter. Typically this is 1Meg ohms or more.

°C = 5/9 (°F-32)

°F = (9/5 * °C) +32

34.2 Orifice Size Chart

Model	Gas Type	Main Burner Orifice	Model	Gas Type	Main Burner Orifice
SSHLV (ROV)	Nat	#47	SSHLVT (ROV)	Nat	#48
	LP	1.25 mm		LP	1.25 mm
SG14	Nat	#41	SGM34	Nat	#42
	LP	#53		LP	1.5 mm
SG14R	Nat	#38	SSH55	Nat	#46
	LP	.062"		LP	#55
SG14T	Nat	#43	SSH55T	Nat	#46
	LP	1.45 mm		LP	#55
SG18	Nat	#41	SSH55R	Nat	#43
	LP	#53		LP	1.45 mm
SG18F	Nat	#41	SSH55TR	Nat	#43
	LP	#53		LP	1.45 mm
SG6H	Nat	#41	SSH60	Nat	#46
	LP	#53		LP	#55
MGII	Nat	#46	SSH60R	Nat	#43
	LP	#55		LP	1.45 mm
MGIIIT	Nat	#46	SSH60W	Nat	#46
	LP	#55		LP	#55
SGH50	Nat	#46	SSH60WR	Nat	#43
	LP	#55		LP	1.45 mm
SGH50T	Nat	#46	SSH75	Nat	#45
	LP	#55		LP	1.35mm
SG18HP	Nat	#45	SSH75R	Nat	#43
	LP	1.35 mm		LP	1.45 mm
SGM1824	Nat	#40	SRTG	Nat	#42
	LP	0.0625"		LP	#53

34.3 Orifice Size at Sea Level Chart

Orifice Size at Sea Level	Orifice Size Required at Other Elevations								
	2000	3000	4000	5000	6000	7000	8000	9000	10,000
30	30	31	31	31	31	32	32	33	35
31	32	32	32	33	34	35	36	37	38
32	33	34	35	35	36	36	37	38	40
33	35	35	36	36	37	38	38	40	41
34	35	36	36	37	37	38	39	40	42
35	36	36	37	37	38	39	40	41	42
36	37	38	38	39	40	41	41	42	43
37	38	39	39	40	41	42	42	43	43
38	39	40	41	41	42	42	43	43	44
39	40	41	41	42	42	43	43	44	44
40	41	42	42	42	43	43	44	44	45
41	42	42	42	43	43	44	44	45	46
42	42	43	43	43	44	44	45	46	47
43	44	44	44	45	45	46	47	47	48
44	45	45	45	46	47	47	48	48	49
45	46	47	47	47	48	48	49	49	50
46	47	47	47	48	48	49	49	50	50
47	48	48	49	49	49	50	50	51	51
48	49	49	49	50	50	50	51	51	52
49	50	50	50	51	51	51	52	52	52
50	51	51	51	51	52	52	52	53	53
51	51	52	52	52	52	53	53	53	54
52	52	53	53	53	53	53	54	54	54
0.062	0.062	53	53	53	53	53	54	54	54
53	54	54	54	54	54	54	55	55	55
54	54	55	55	55	55	55	56	56	56
55	55	55	55	56	56	56	56	56	57
56	56	56	57	57	57	58	59	59	60
57	58	59	59	60	60	61	62	63	63
58	59	60	60	61	62	62	63	63	64
59	60	61	61	62	62	63	64	64	65
60	61	61	62	63	63	64	64	65	65

35 Simplified Wiring Diagrams

NOTE: The following wiring diagrams represent the latest revisions and most common models. A current wiring diagram for the fryer can be found on the inside of the fryer door or call the Pitco Service Department for your particular unit.

35.1 Wiring Diagram – Heat Control Wiring Left & Right (ROV)

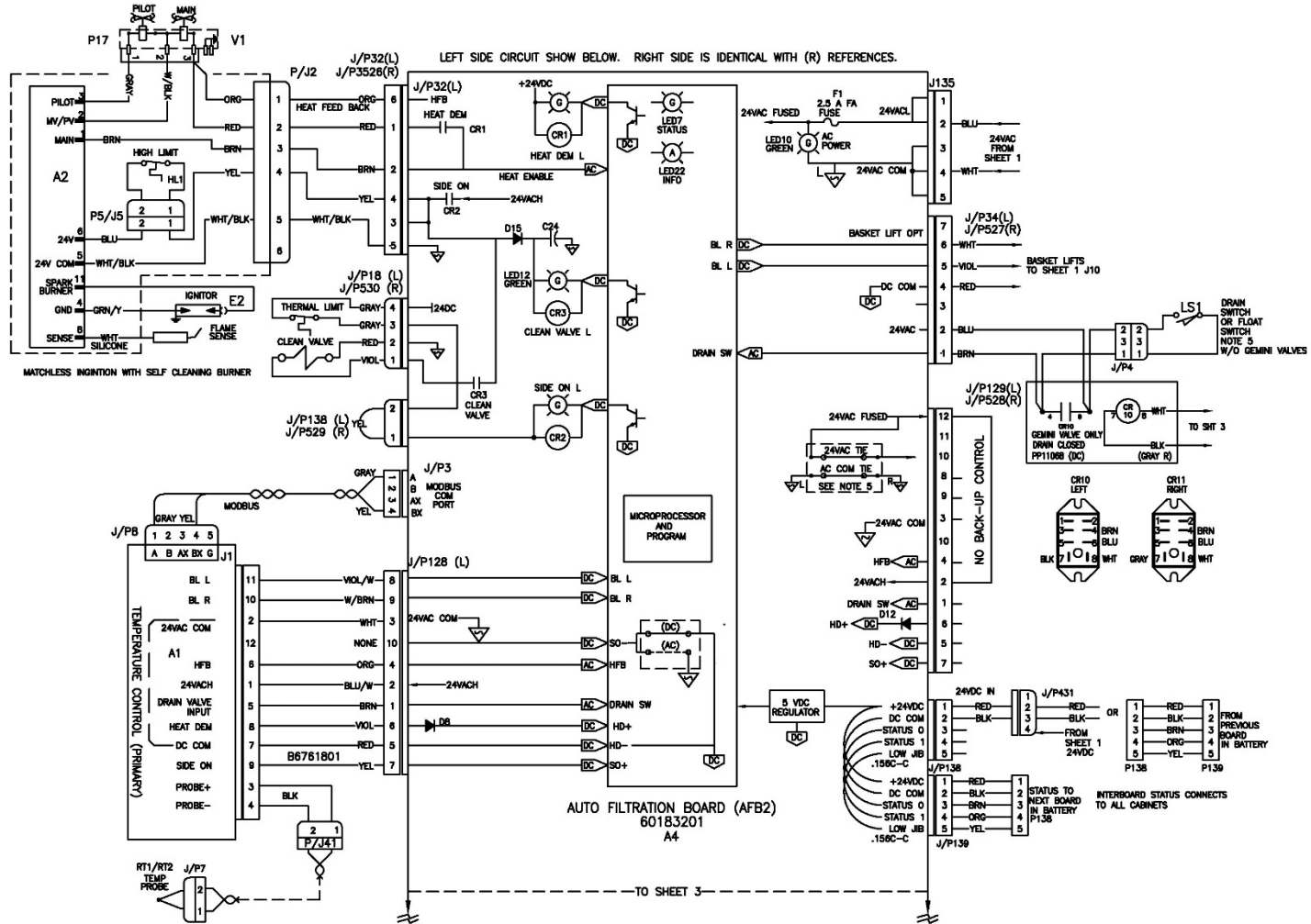

35.2 Wiring Diagram – Auto Filter Board (AFB2) Wiring (ROV)

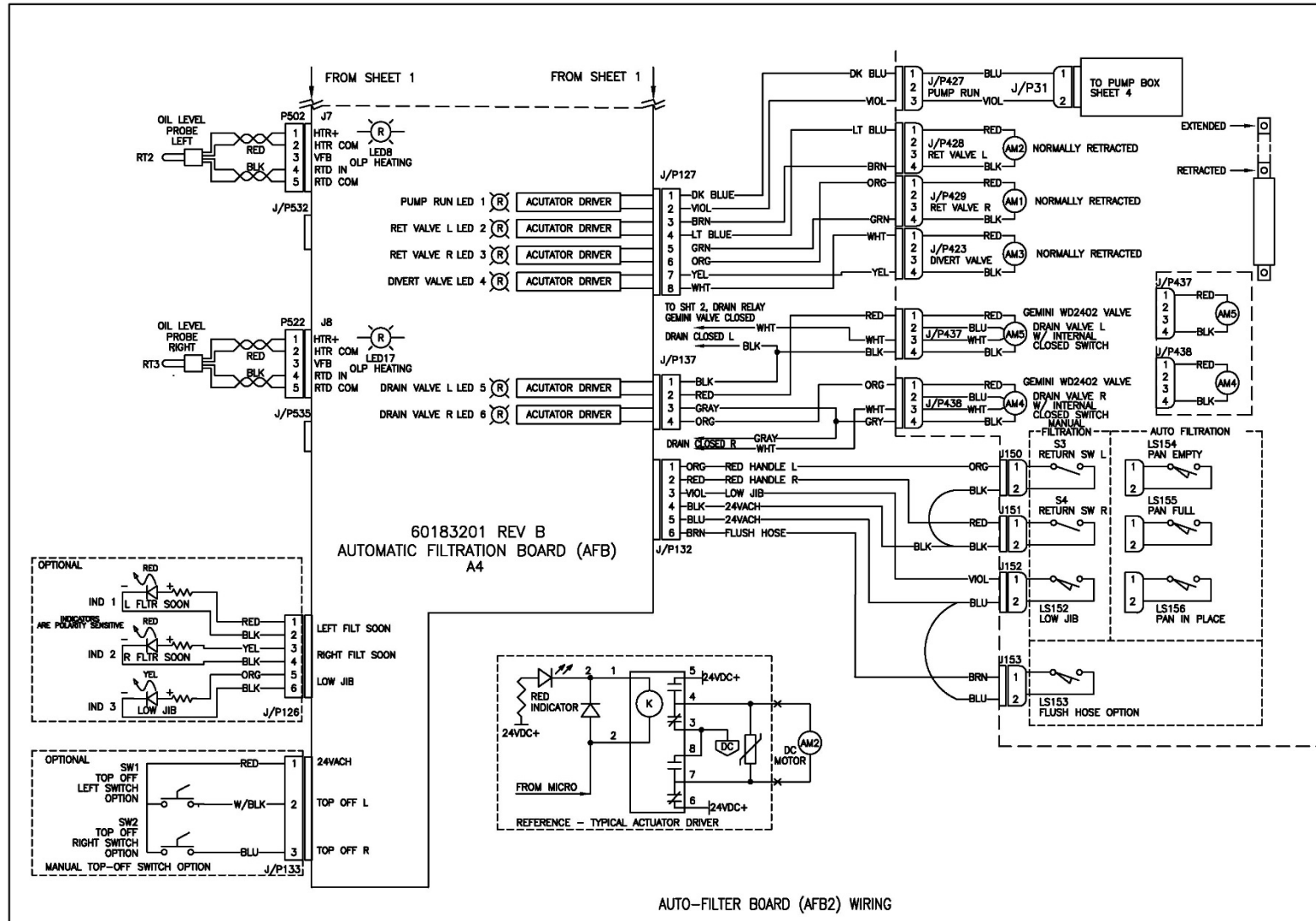

35.4 Wiring Diagram – Calibration Test Points and Indicators (ROV)

STATUS TO COOKING CONTROL AND ALL OTHER CABINETS (BULK OIL OPT)					
LED7	RESOURCE	DESCRIPTION	BIT 0	BIT 1	BIT 2
8	IDLE	NO FILTER OPERATIONS	1	1	1
7	NONE	-	0	1	1
6	WASTE & PUMP	DISPOSING	1	0	1
5	NONE	-	0	0	1
4	DIVERT & PUMP	TOP OFF (1)	1	1	0
3	DIVERT ONLY	TOP OFF (2) NOT USED	0	1	0
2	PUMP ONLY	FILTERING	1	0	0
1	HOLD/LOCKOUT	DRAINING	0	0	0

NOTE: "1" IS 24VDC TO DC COM.

FLASH CODES FOR STATUS INDICATOR (WITHOUT BULK OIL OPTION)			
LED7	BIT 0	BIT 1	FLASH CODE
IDLE	1	1	4
DRAIN	0	1	3
TOP OFF	1	0	2
FILTER	0	0	1

FLASH CODES FOR "INFO" LED, AMBER (LED22)

MODBUS COMM PORT		OIL LEVEL PROBE		
#1	#2 LEFT SIDE	#3 RIGHT SIDE	DESCRIPTION	
2 DIGIT CODE	2 DIGIT CODE	2 DIGIT CODE		
11	21	31	-	
12	22	32	DETECTING OIL	
13	23	33	DETECTING OIL, RECENT TOP OFF	
14	24	34	IDLE, WAITING FOR READY	
15	25	35	PROBE FAULT	
16	26	36	-	
17	27	37	-	
18	28	38	-	
19	29	39	-	
NONE (1)	NONE (2)	NONE (3)	-	

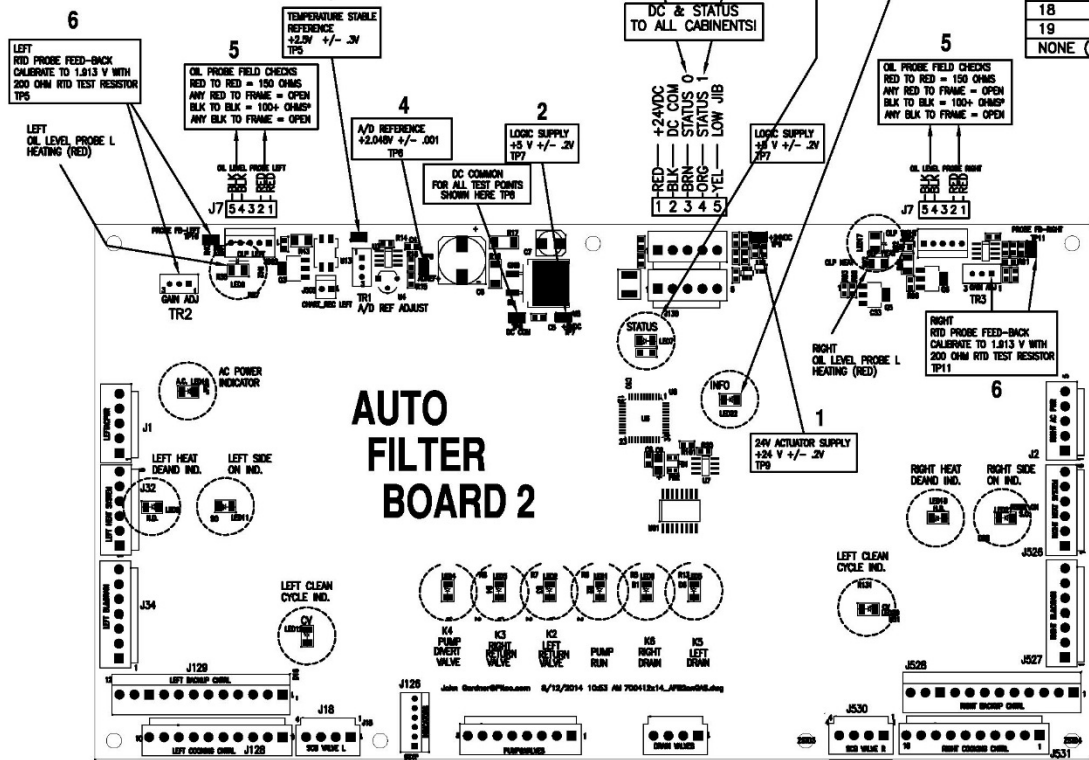

CALIBRATION TEST POINTS AND INDICATORS

Auto Filter Board appears dead

Tag	What?	Test Point
1	24VDC Applied to Board?	TP9
2	5 VDC Regulator? Status and Info LEDs should be flashing.	TP7
3	Temperature Stable Reference 2.5V nominal?	TP5
4	A to D Reference Voltage 2.048V?	TP6

Left or Right Oil Level Probe not functioning.

Tag	What?	Value Ohms
5	Unplug probe at J7. Measure ohms RED to RED	150
	Either RED to frame. Should be OPEN.	Open
	Measure RTD resistance BLK to BLK. Varies with temperature. 100 ohms @ 32F. 167 @ 350F.	>100 & <167
	Either BLK wire to frame. Open	Open
	If ok, re-plug probe at J7.	

Tag	What?	Test Point
6	Unplug probe at J7. Install test connector w/200 ohm dummy RTD across terminal 4 & 5.	
	Measure TP for 1.913 Volts. Adjust TR2 (L) to obtain on left side. Adjust TR3 to obtain on Right side.	TP5 (L) TP11(R)
	Replug probe at J7. When the red OLP heating light comes on, >23VDC should be present across RED wires of probe.	

35.5 Wiring Diagram – AC & DC Control Voltage Supplies (ROV)

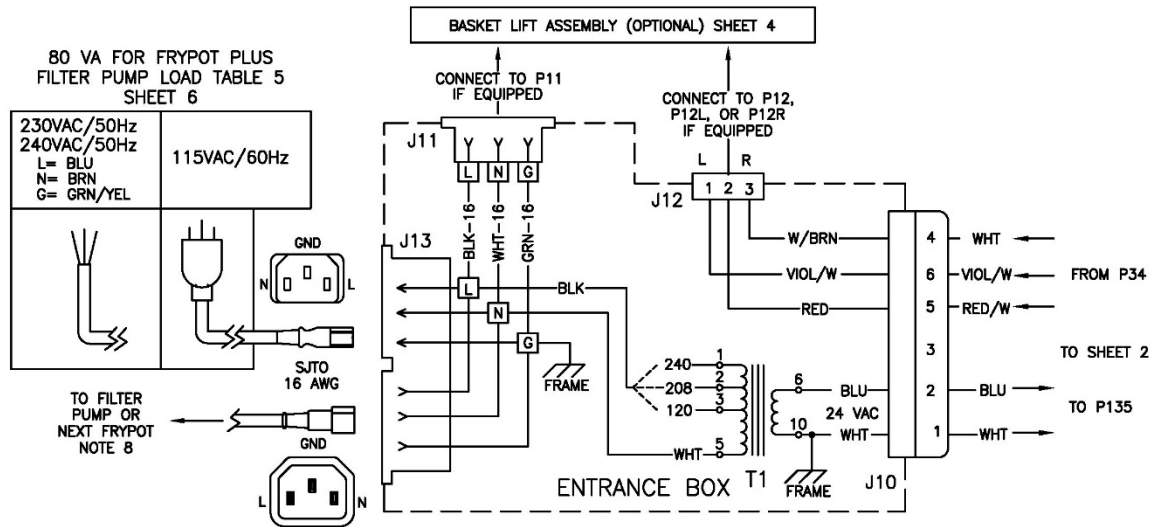

160VA PER APPLIANCE PLUS
BASKET LIFT OPTION IF INSTALLED

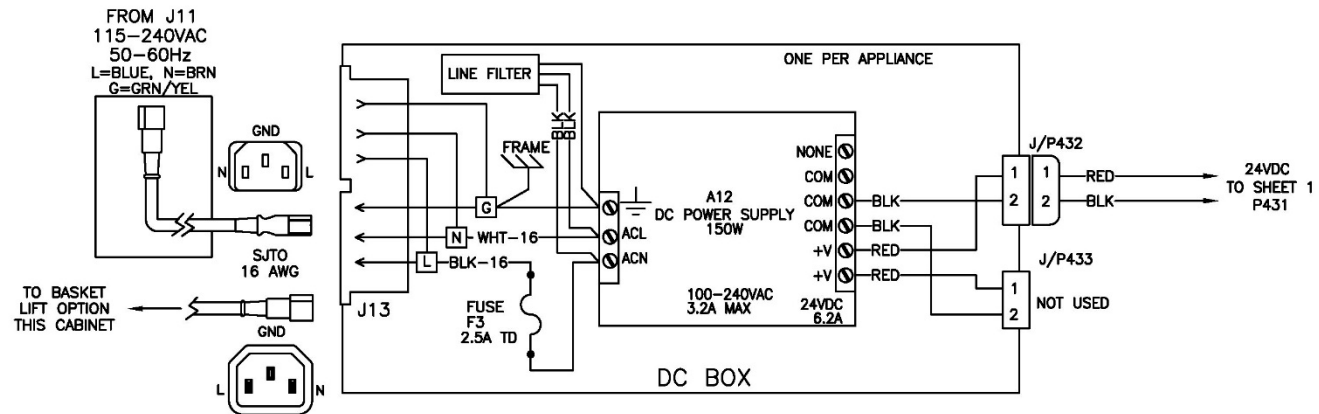

AC & DC CONTROL VOLTAGE SUPPLIES

35.6 Wiring Diagram – Basket Lift Option & Connector Locations (ROV)

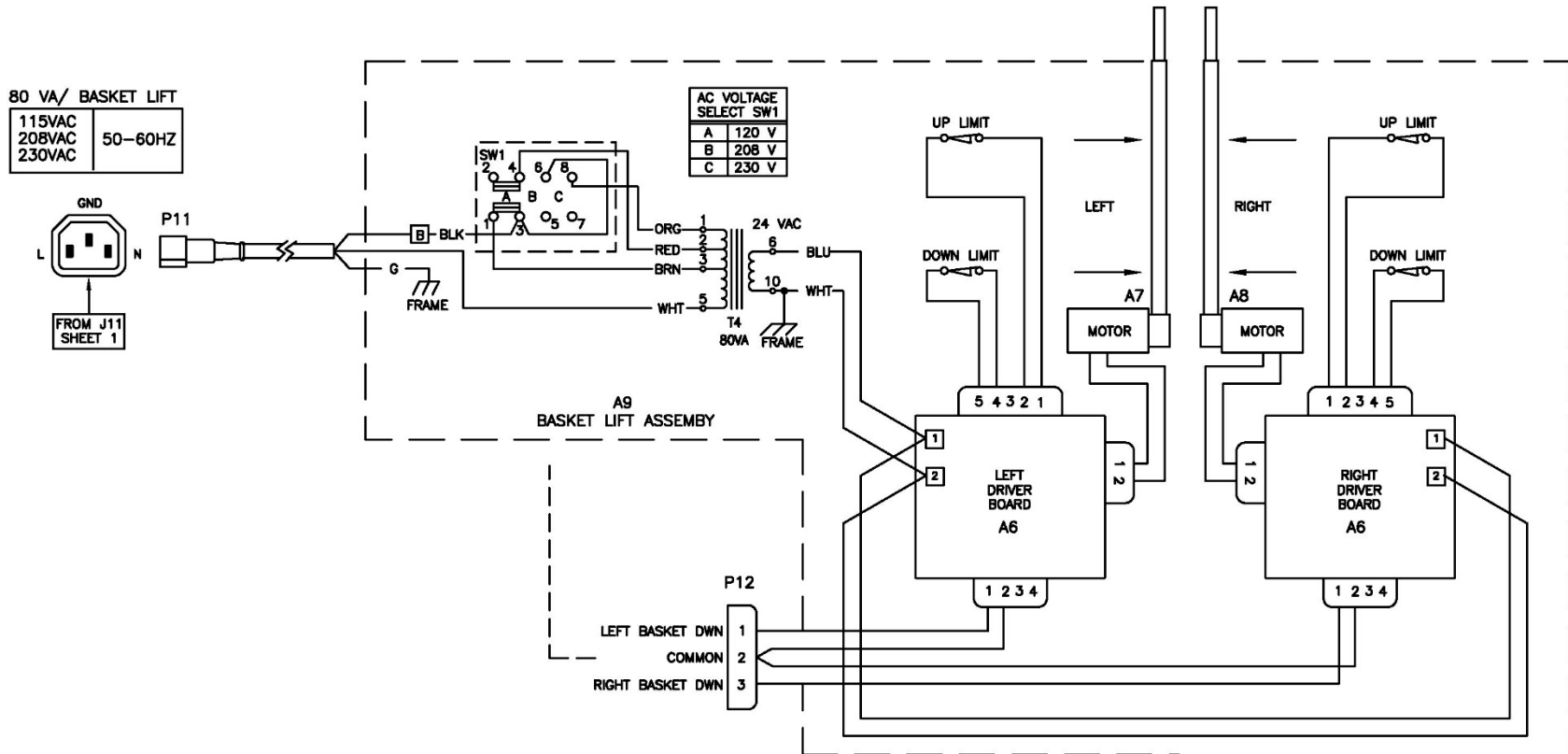

BASKET LIFT OPTION
& CONNECTOR LOCATIONS

35.7 Wiring Diagram – Filter Pump Options 208V-240V (ROV)

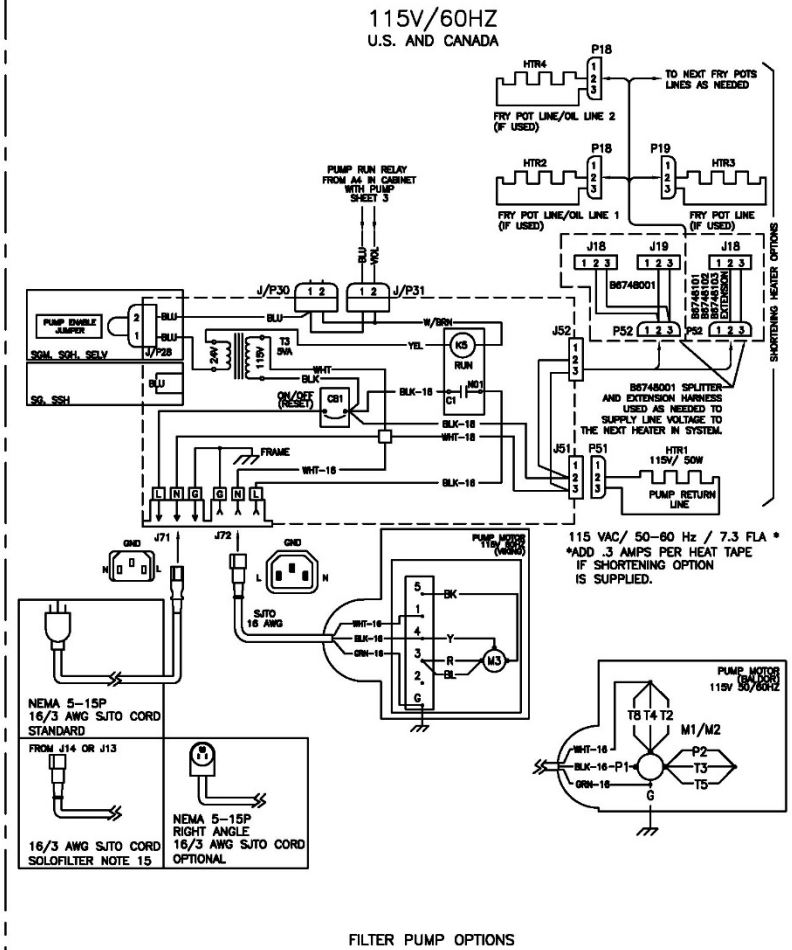
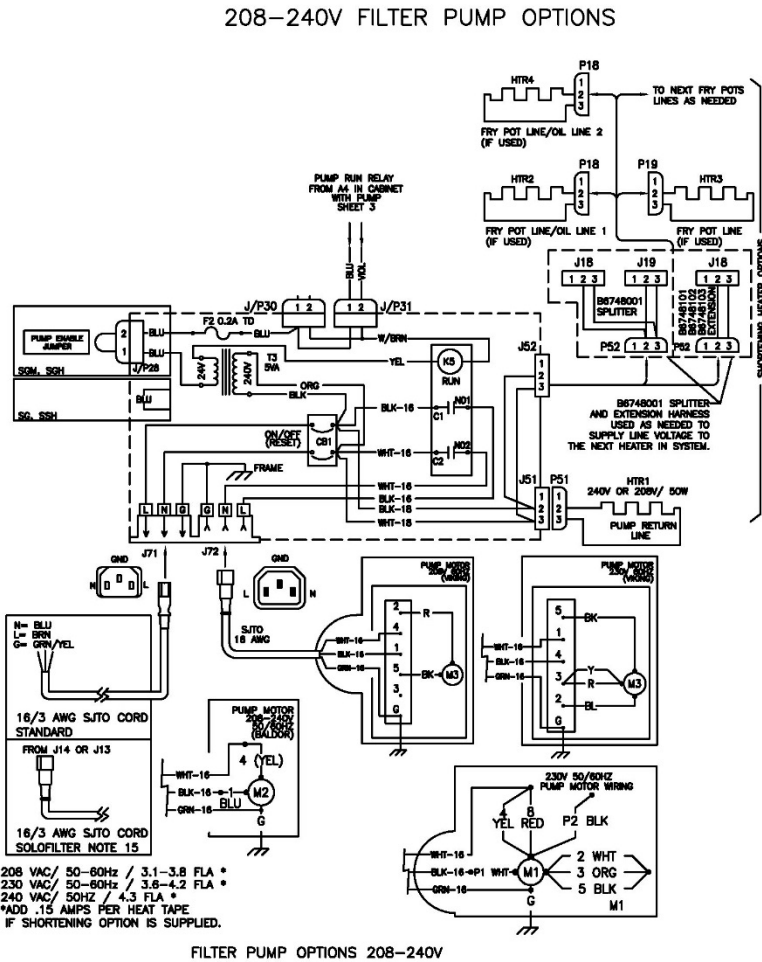

35.8 Wiring Diagram – Full Vat with SCB

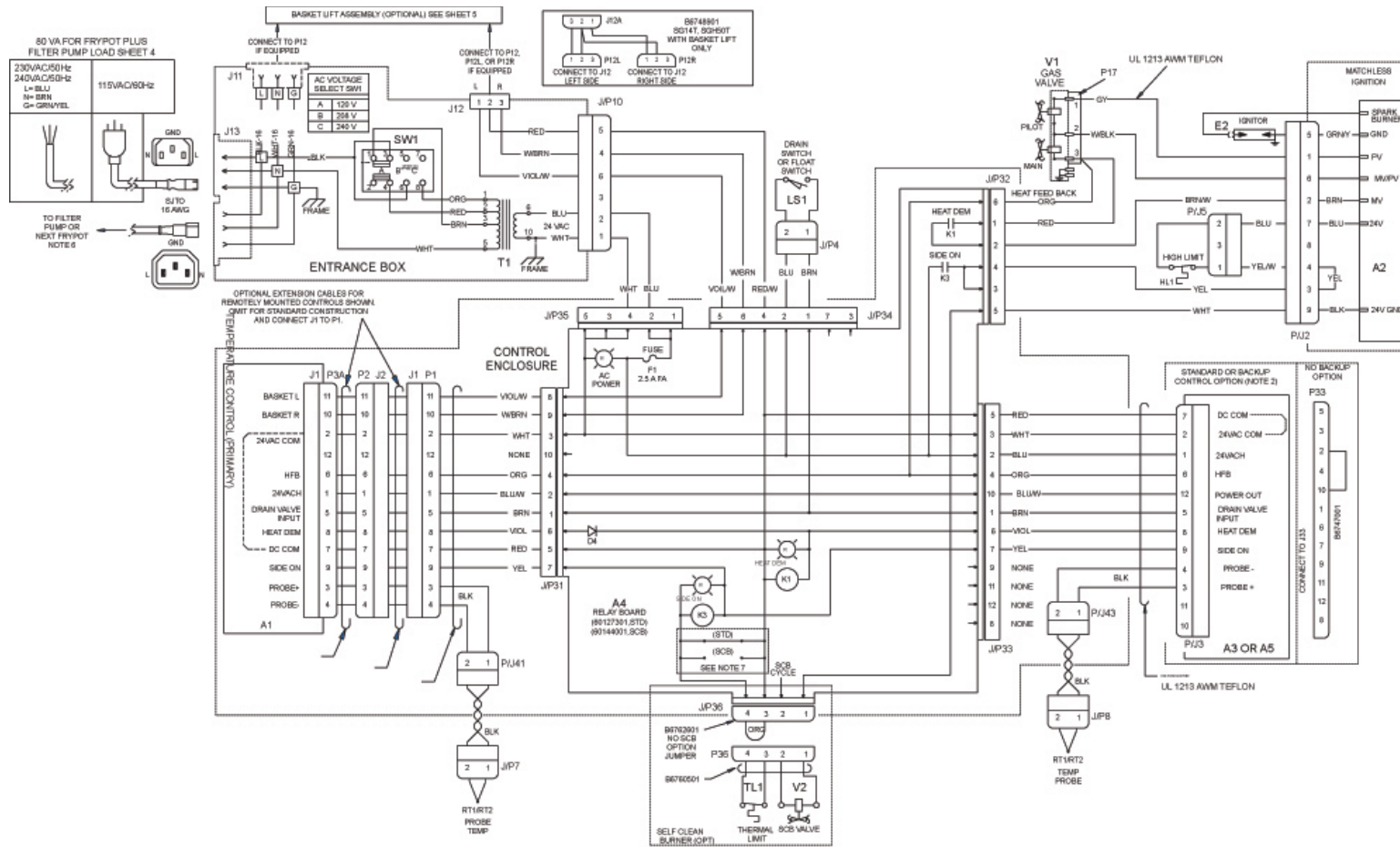

Full Vat With SCB

35.9 Wiring Diagram – Basket Lifts

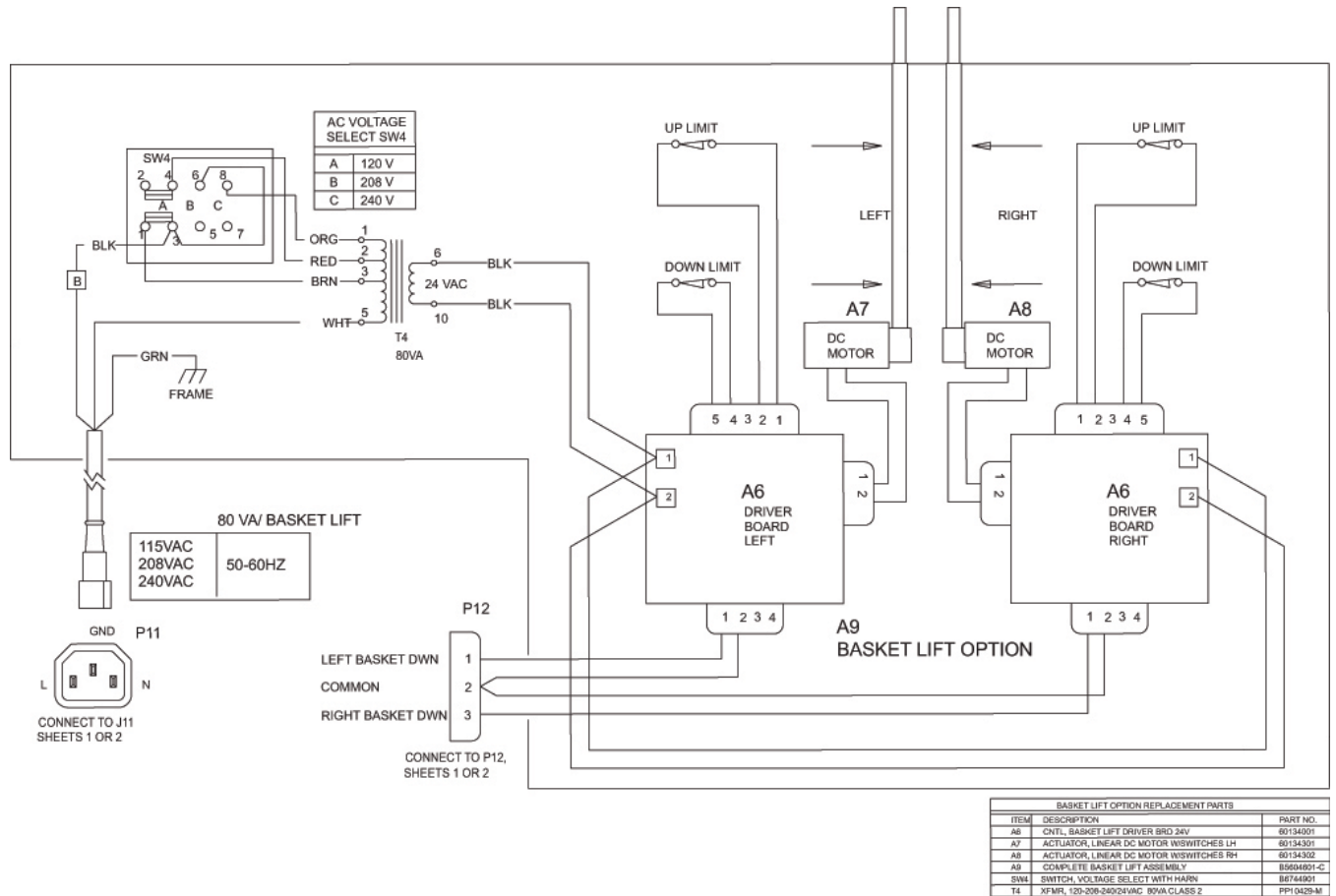

35.10 Wiring Diagram – Filter Motor 115V-60Hz

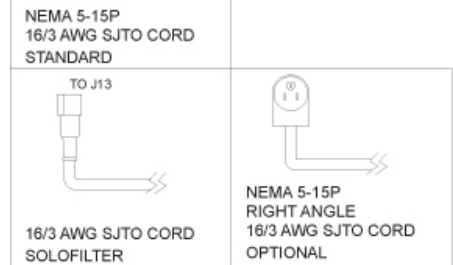
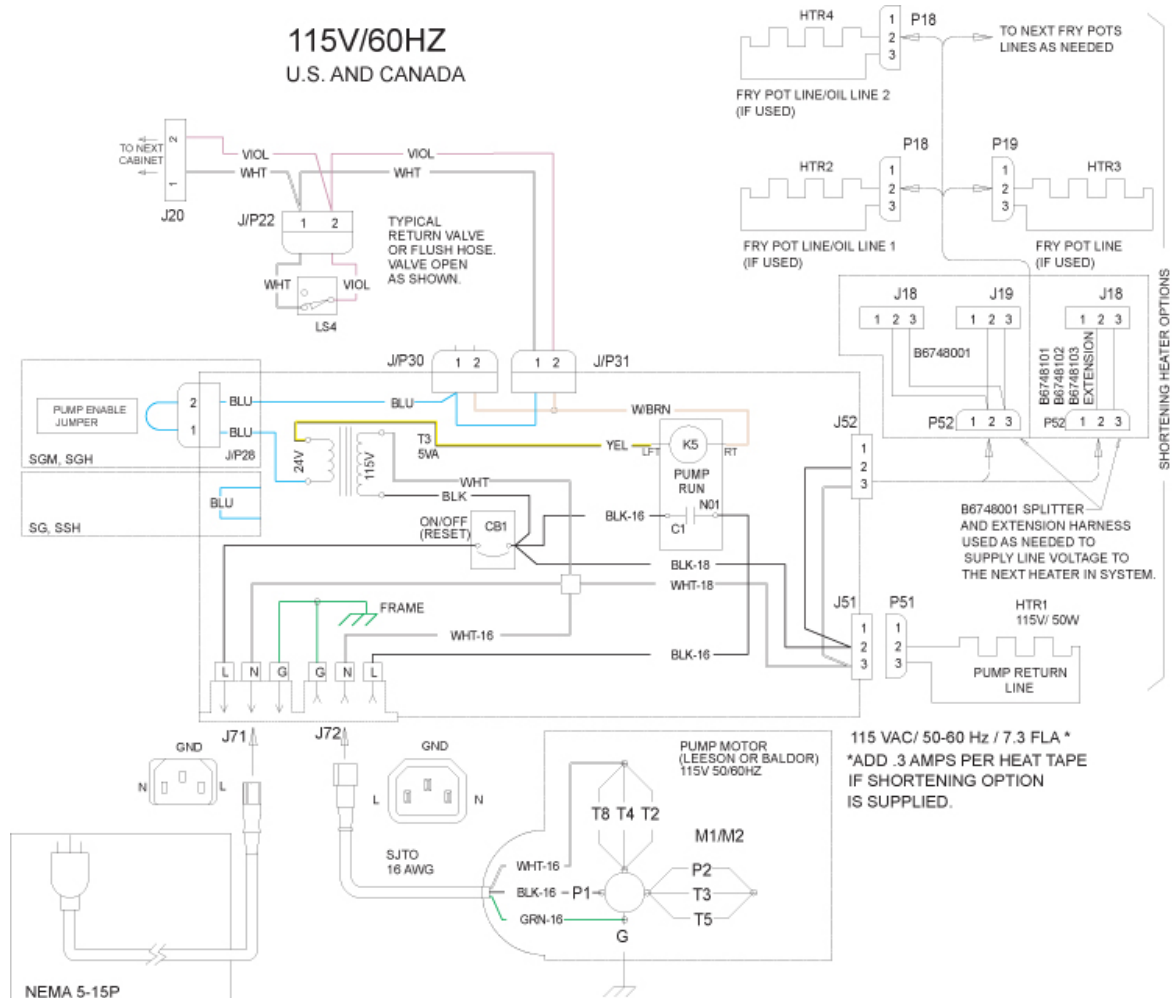

FILTER PUMP REPLACEMENT PARTS			
ITEM	VOLTAGE	DESCRIPTION	PART NO.
CB1	120V-50/60Hz	CKT BRKR, 10 AMP SINGLE POLE	60077901
	208-240V 50/60Hz	CKT BRKR, 5 AMP TWO POLE	60078502
F2	ALL	FUSE 0.2A 250V TIME DELAY CERAMIC	60132701
FH2	ALL	FUSE HOLDER, IN LINE, .25 X 1.25	PP10765
K5	120V-50/60Hz	RELAY, 24VAC, 30A SPST	PP11058
	208-240V 50/60HZ	RELAY, 24VAC, 30A DPST	60104701
LS4	ALL	SWITCH, PROXIMITY MAGNETIC	B5305001
		SWITCH, ACTUATOR MAGNETIC	PP10263
M1 (HAIGHT)	120V-50/60Hz	MOTOR AND PUMP 1/3HP, 8GPM	60130801
	230V-50/60Hz	MOTOR AND PUMP 1/3HP, 8GPM	60130802
	240V/50Hz	MOTOR AND PUMP 1/3HP, 8GPM	60130802
	208V-50/60Hz	MOTOR AND PUMP 1/3HP, 8GPM	60130808
M1 (HAIGHT) 5GPM	120V-50/60Hz	MOTOR AND PUMP 1/3HP, 5GPM	60130806
	230V-50/60Hz	MOTOR AND PUMP 1/3HP, 5GPM	60130807
	240V/50Hz	MOTOR AND PUMP 1/3HP, 5GPM	60130807
	208V-50/60Hz	MOTOR AND PUMP 1/3HP, 5GPM	60130810
M2 (VIKING)	115V-50/60Hz	MOTOR AND PUMP 1/3HP, 8GPM	60143501
	230V-50/60Hz	MOTOR AND PUMP 1/3HP, 8GPM	60143503
	208-240V/50/60Hz	MOTOR AND PUMP 1/3HP, 8GPM	60143503
M2 (VIKING) 5GPM	115V-50/60Hz	MOTOR AND PUMP 1/3HP, 5GPM	60143502
	230V-50/60Hz	MOTOR AND PUMP 1/3HP, 5GPM	60143502
	208-240V/50/60Hz	MOTOR AND PUMP 1/3HP, 5GPM	60143504
	120V-50/60Hz	XFMR, 120/24VAC 5VA	60130301
T3	230V-50/60Hz	XFMR, 240/24 VAC 5VA	60130302
	240V-50Hz	XFMR, 240/24 VAC 5VA	60130302
	208V-50/60Hz	XFMR, 208/24VAC 5VA	60130303

Pitco SSHLV (ROV) Gas Fryers

NOTES:

Pitco SSHLV (ROV) Gas Fryers

NOTES:



<p>In the event of problems with or questions about your order, please contact the Pitco Frialator factory at: (603)-225-6684 World Wide Website Address: www.pitco.com</p>	<p>In the event of problems with or questions about your equipment, please contact the Pitco Frialator Authorized Service and Parts representative (ASAP) covering your area, or contact Pitco at the number listed to the left.</p>
<p>MAILING ADDRESS – P.O. BOX 501, CONCORD, NH 03302-0501 SHIPPING ADDRESS – 10 FERRY STREET, CONCORD, NH 03301</p>	