

Owners Manual

Installation - Operation - Maintenance



Electric Modular Ovens

700 series

PM 721 – PM 722 – PM 723 – PM 724 – PM 725

PM 731 – PM 732 – PM 733 – PM 734 – PM 735

PM 741 – PM 742 – PM 743 – PM 744 – PM 745

800 series

PM 821 – PM 822 – PM 823 – PM 824 – PM 825

PM 831 – PM 832 – PM 833 – PM 834 – PM 835

PM 841 – PM 842 – PM 843 – PM 844 – PM 845

900 series

PM 911 – PM 912 – PM 913 – PM 914 – PM 915

PM 921 – PM 922 – PM 923 – PM 924 – PM 925

PM 931 – PM 932 – PM 933 – PM 934 – PM 935

PM 941 – PM 942 – PM 943 – PM 944 – PM 945

APPROVALS *approvals vary depending on market*

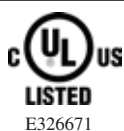
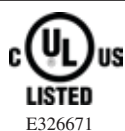



Quality tastes better

PizzaMaster® ovens are designed and built by Svenska BakePartner AB

We thank you for your trust and congratulate you on the purchase of your new PizzaMaster® oven. Your new oven is a result of our goal to build the very best pizza ovens in the world. Built into the oven is our in-depth knowledge of pizza baking that daily help customers all around the world to bake pizza very fast and with a very high quality in one of our 80 different PizzaMaster® oven models.

2-year manufacturer's warranty

All PizzaMaster® ovens come with a 2-year limited warranty that covers the purchaser against any defect in material or workmanship. For further details about this important cover, please consult your PizzaMaster® representative.

Special expertise

PizzaMaster® service technicians are trained specialists. They are equipped with all instruments and tools needed to make the correct diagnosis and perform service work quickly and efficiently. Our technicians travel the world continuously, training local technicians to uphold the PizzaMaster® standard.

Genuine parts

Your PizzaMaster® oven consists of over 1000 quality parts with long service life. Should it become necessary to replace a part, it is most important to replace it with a genuine PizzaMaster® part. This ensures not only optimum function but also continued safety in the workplace.

<p>BakePartner Made in Sweden</p> <p>Svenska BakePartner AB</p> <p>Odegardsgatan 5 504 64, Borås Sweden</p> <p>Phone: +4633 230 025 info@bakepartner.com www.bakepartner.com www.pizzamaster.com</p>	Model - Type PM Oven Model	Serial No. X0000 - 00X00
	Power Supply	IP
	Power Oven (kW)	X100 X200 X300
	X500 X400 X300 X200 X100	X400 X500 Total kW

Your PizzaMaster® oven

When contacting your local PizzaMaster® distributor or BakePartner direct for assistance, remember to quote the model designation and serial number of your oven, a copy of the power rating plate is placed above on the original owners manual that follows each oven delivered from our factory. This help us to help you more quickly.

Look for the PizzaMaster® original parts logo when ordering replacement parts



PizzaMaster® Stone Hearth Deck Ovens are manufactured by Svenska BakePartner AB

Customer Support: Tel: +46 33 230-025 | E-mail: info@bakepartner.com

Website: www.pizzamaster.com or www.bakepartner.com | HQ: Svenska BakePartner AB, Odegardsgatan 5, SE 504 64 Borås Sweden

INDEX

Warranty and service	2
Index.....	3
Safety and Warnings	4
Installation – Assembly oven	5
Installation – Assembly accessories.....	13
Installation – Electrical connection oven.....	14
Installation – Evacuation connection	18
Installation – Steam System.....	19
Installation – Assembly UBC	21
Installation – Automatic door opener.....	23
Oven operation – Display ED	24
Oven operation – Display E.....	29
Oven operation - First-time start-up	31
Clock timer	32
Pizza Recipe / Oven Settings / Baking Guidelines.....	36
Maintenance and Preventative Maintenance	38
Changing of oven lamp and door gasket.....	41
Troubleshooting.....	42
Capacities and technical data	44
EU-Declaration of conformity	45
Notes	46

Attachment :

Electrical diagram

Svenska BakePartner has a policy of continuous product development and reserves the right to change specifications and designs without prior notice.

Safety Precautions and Warnings



To ensure safe operation, read the following manual that contains safety precautions and warnings for your own safety



High Risk of Electrocution!

Disconnect appliance from power supply before opening.

To reduce the risk of electric shock, DO NOT remove or open electrical cover. Refer servicing to qualified personnel.



This appliances is not intended for use by persons (including children) with reduced physical, sensory or mental capabilities, or lack of experience and knowledge, unless they have been given supervisory or instruction concerning use of the appliance by a person responsible for their safety.



The oven is normally installed on the legs supplied with it. It is also important for the floor to be flat, so that the oven is both horizontal and stable.



For ventilation reasons, position the oven leaving 50mm (2") between the oven and any adjacent wall



If possible, position the oven so that its right-hand side can be accessed easily in order to remove the right-hand panel. This gives easy access to the back of the control panel and facilitates servicing of the oven.



The appliance must be installed with an adequate restraining to limit the movement of the appliance without transmitting stress to the electrical conduit. The restraining must be fastened in one of the supports leg or spacers.

The appliance must be installed with a flexible conduit.



DO NOT place any object blocking the ventilation. this affects the baking, oven performance and may cause fire



The top of the oven is not considered as a food storage or as an food preparation area.

Assembly For Ovens With Legs

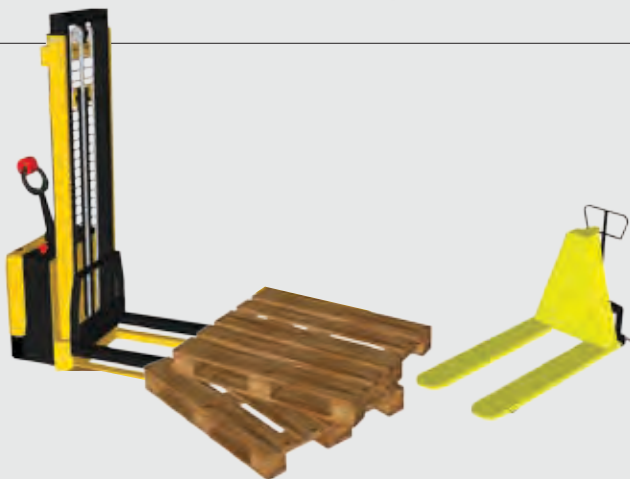

YOU WILL NEED at least 2 standard pallets. Depending on the oven's size and weight, you will need a manual lift, pallet truck, forklift or Genie lift (USA), (see illustration)

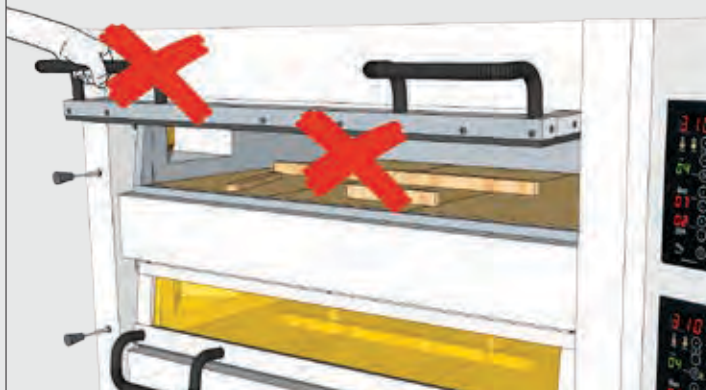

DO NOT carry the oven by the door handle and **DO NOT** remove the wooden stone supports until the oven is installed

Unpack and prepare



1. The oven is packed safely and for easy transportation. Do not drop it or allow hard knocks

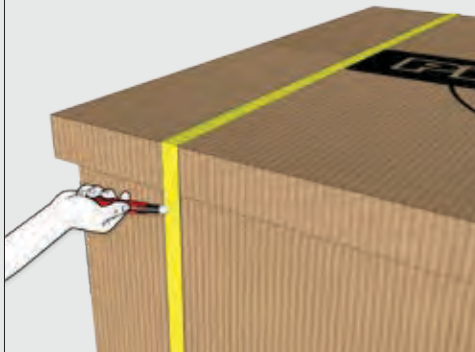

2. Cut the packing bands and remove the top and side cardboards



3. DO NOT carry the oven by the door handle and do not remove the wooden stone supports until the oven is installed



4. Remove wooden stone supports from top deck. Remove legs (carefully) and accessories from inside. Replace the wooden stone supports

Steps for 1 to 2 decks ovens



For 1 or 2 Decks Ovens Follow Steps 5 to 15



5. Place a pallet behind the oven



6. If the oven has a Steam System, place "wooden blocks" to lay the oven down in a higher position



7. Turn the oven back side down, make sure that the stones have not moved



8. Use a pallet jack/ pallet truck to transport the oven in this position to pass through doors or narrow areas

Assembling



9. Transport the oven carefully. Place a verticle pallet, make sure not to block the leg bolt holes in the bottom of the oven



10. Check the maximum height of the pallet truck/genie lift so the oven is high enough to bolt the legs underneath



11. Place more pallets under to reach the desired height

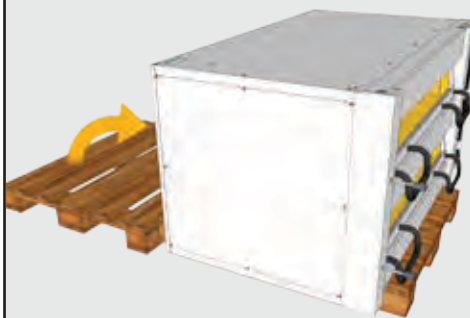

12. Turn the oven upright carefully



13. Place pallet truck/genie lift in front of the oven



14. Lift the oven high enough to bolt the legs easily



15. Continue at step 26 for legs installation

Steps for 3 to 4 decks ovens



For 3 to 4 Decks Ovens Follow Steps 16 to 20

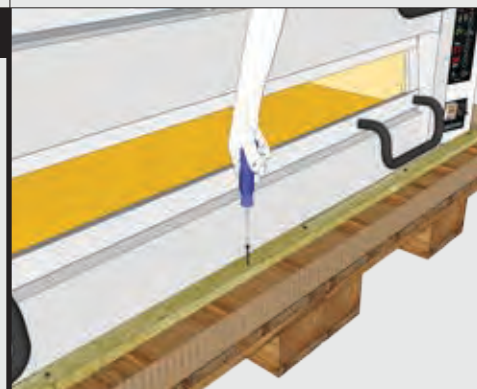

16. Remove the front and back wooden stick

Assembling



17. Remove the staples from one side of the oven

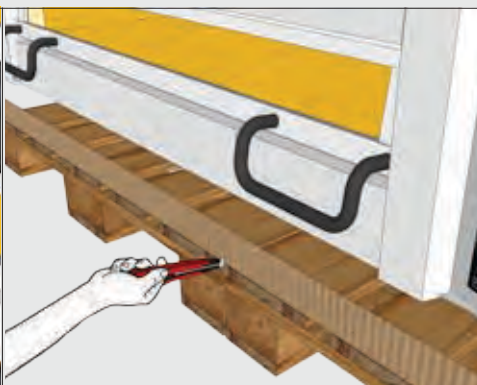

18. Cut the cardboard between every pallet



19. Push and center steady the oven over the biggest pallet and remove the other(s) pallet(s)



20. Carefully lift the oven using a pallet truck, forklift or Genie lift, depending upon the weight of the oven. (Continue at step 26)

Steps for 5 decks ovens



For 5 Decks Ovens Follow Steps 21 to 25



21. Remove the cardboard



22. Remove the hex bolts and take out the wood cage



23. Carefully lift the oven using a pallet truck, forklift or Genie lift, depending of the weight of the oven



24. Remove the 8 hex bolts M10x30 under the oven and keep them

Support Assembling

Continue here for all models

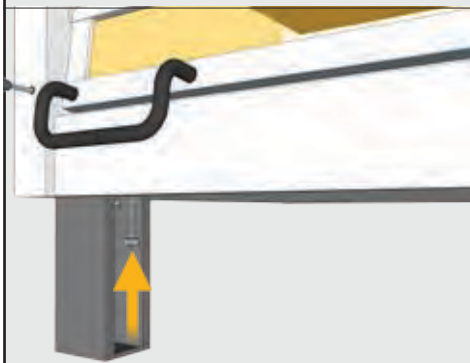

25. Use these hex bolts to place the legs, follow the next steps. (Continue at step 26)

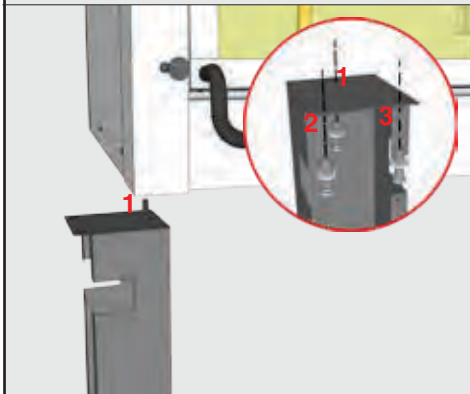

26. Use 3 bolts M10x30 and 1 washer per bolt 20x10.5 (provided). Rotate the leg 180° out to place the inside bolt first,



27. Let the bolt loose and rotate the leg 180°



28. Tighten the bolts alternately for better fit. Hand tight all first



29. Make sure that all the legs are firmly and well adjusted

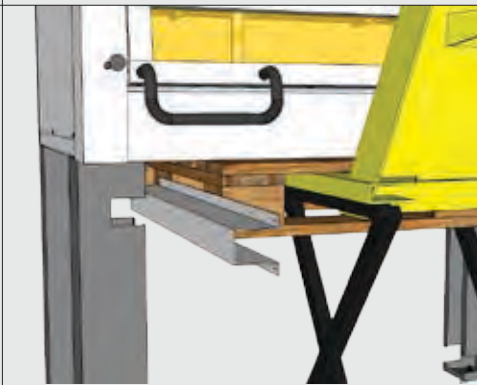

30. DO NOT remove the pallet truck/ genie lift before placing the leg cut-outs



31. Fit all four shelf slide rails in place in the leg cut-outs

Accessories Assembling



32. Secure the side rails with the 4 hexagonal screws (provided)



33. Insert the sliding shelf into either the upper or the lower pair of rails (1 shelf provided as standard). Order a second shelf separately as an accessory



34. To place the shelf blockers, pull out the shelf and place them behind both front legs. With two shelves, place two on the top and two on the bottom

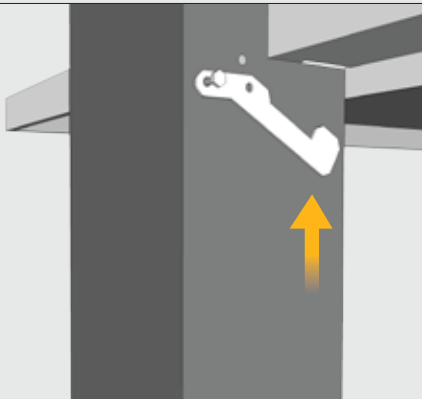

35. Use 2 self-tapping screws per blocker

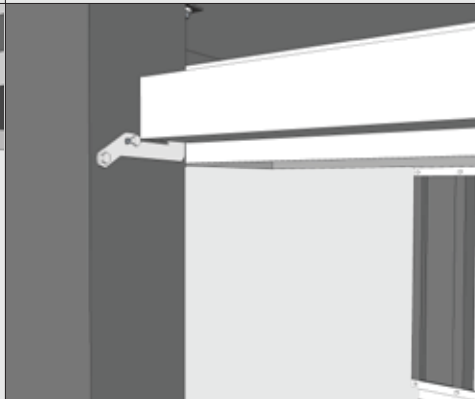

36. Fit the shelf blocker and repeat in the other front leg

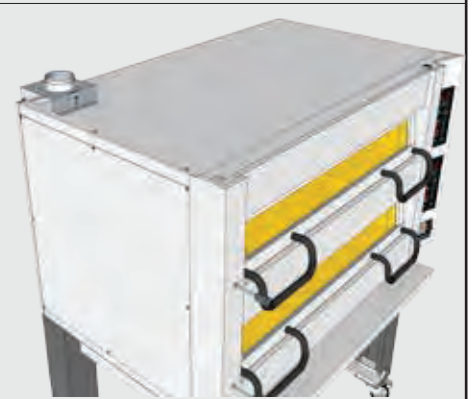

37. Attach the back flue diverter, using 3 self-tapping screws (wafer head, provided)

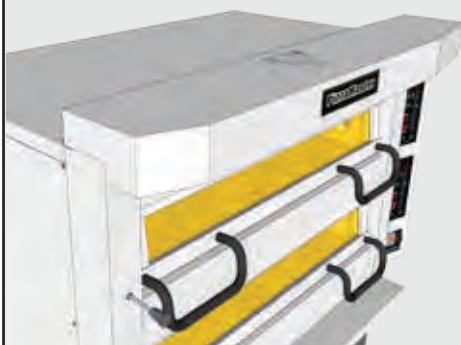

38. Place the Eyebrow hood piece

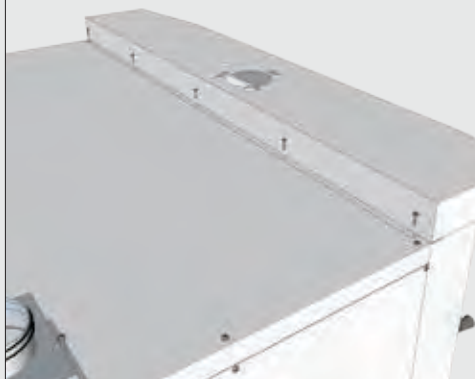

39. Attach front Eyebrow piece with self-tapping screws (wafer head)



40. Place the front flue diverter

Finalize Installation



41. Bend over metal tabs to secure flue connection

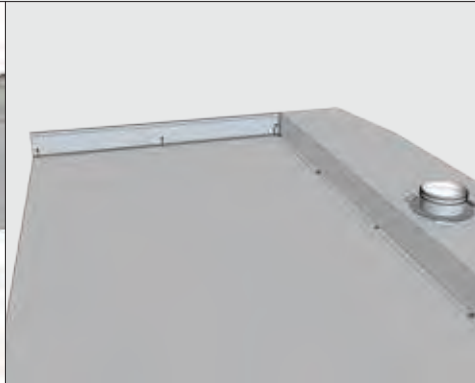

42. Fit the Top Side panels

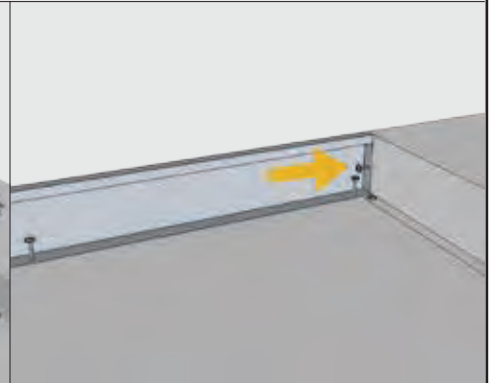

43. Make sure to put the screw between the Top Side panels and the Eyebrow hood

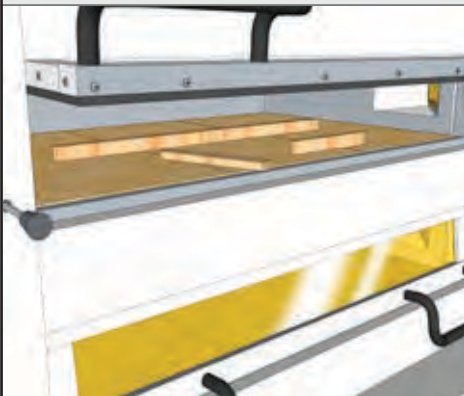

44. Remove the wooden stone supports



45. For ventilation reasons, position the oven leaving 50 mm (2") between the oven and any adjacent wall



46. Position the oven over a flat floor, so the oven is horizontal and stable



47. If possible, position the oven with easy access to the right hand panel to facilitate the electrical installation and future services



48. Read the Owner's manual to install other accessories



CONGRATULATIONS!
Your PizzaMaster oven is now installed. DO NOT remove the "Quick Start Guide" from the handle before the first use

Assembly For Ovens With Spacers

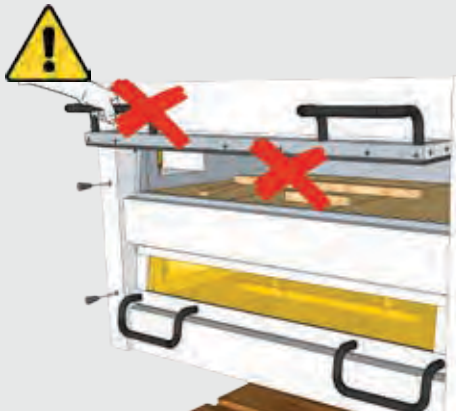

Important!

Do not remove the wooden supports for the hearthstones until you reach point 5 opposite.

Do not use the oven-door handles or the oven-vent knobs to lift the oven, this might damage the oven.



Tip! If possible, use a forklift truck to lift the oven to fit the spacers. Alternatively, lift the oven manually on to a strong table or flat bench, so that the legs can be fitted safely.

Minimum lift height for fitting of legs:

1-deck oven	125mm / 5in
2-deck oven	125mm / 5in
3-deck oven	125mm / 5in
4-deck oven	125mm / 5in
5-deck oven	125mm / 5in



Lift the oven and fit the spacers using the M10x30 bolts (12 pcs) + 20x10.5 washers (12 pcs) provided. For each spacer, first screw in (but do not tighten) the bolts. When all bolts are in place, tighten bolts progressively and alternately to fix the spacer firmly to the oven.

Warning!

Make sure all 12 bolts for assembly the legs on to the oven are in place and proper tightened, before moving the oven.

Assembly - Accesories

Peel Holder



1. Fit the lower bracket, using the self-tapping screws (hexagonal) provided (3 pcs)

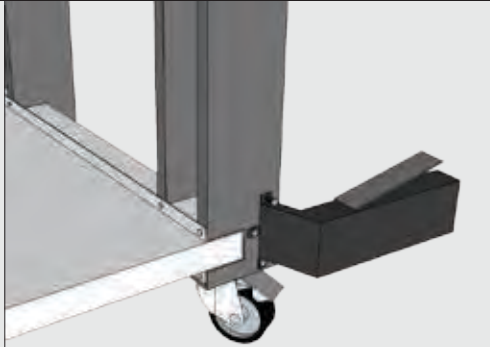

2. Peel off the backing from the soft pad and stick the pad to the lower bracket, as shown in the illustration



3. Now fit the upper bracket, using the self-tapping screws (hexagonal) provided (3 pcs)

Oil-and-spice rack (also holds the slicer)

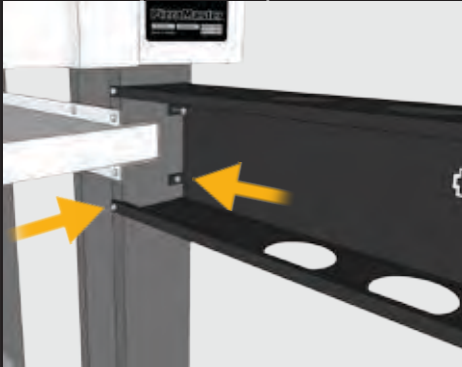

1. Fit the oil-and-spice rack, using the self-tapping screws (hexagonal) provided (4 pcs)

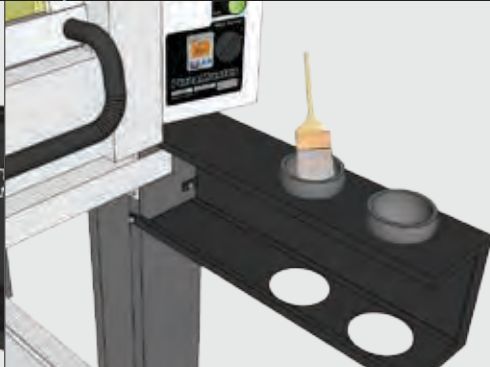

2. Insert the spice bowl and oil bowl with basting brush, as shown below



3. Carefully fold out the lug, as shown below

Side Shelf

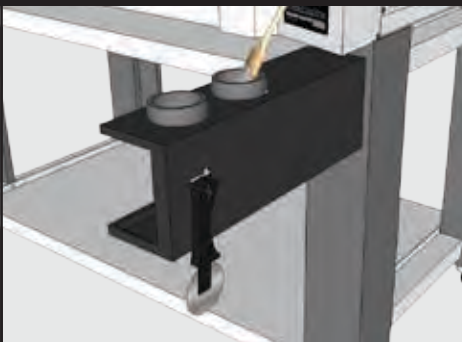

4. Hang the slicer (provided) on the lug

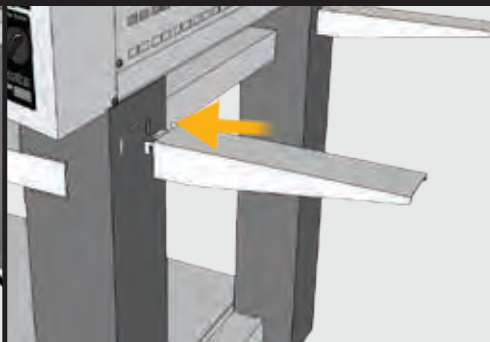

1. Hook the brackets (2 pcs) on to the legs



2. Mount the shelf as shown below

Installation – Electrical connection oven

Electrical connection

For connection and correct fuse rating, see the oven rating plate, the table for fuse protection need and the attached electrical diagram.

After reading **all** above information, follow instructions below for correct electrical connection.

The earth potential equalizer screw has to be installed. The earth potential equalizer screw is located on the backside next to the connecting cable.

Important!

For reasons of safety and the validity of the warranty, all electrical work must be carried out by a qualified electrician.

The oven must be connected via an external main switch with min. 3 mm gap.

Electrical Connection

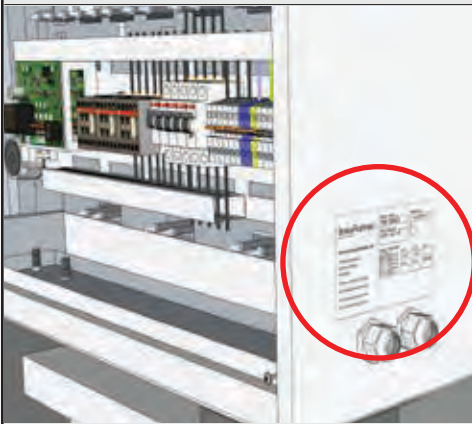

1. Make sure electrical supply corresponds with that specified on the oven rating plate

Remove the screws (6 pcs) that secures the right-hand side panel, and take off the panel.

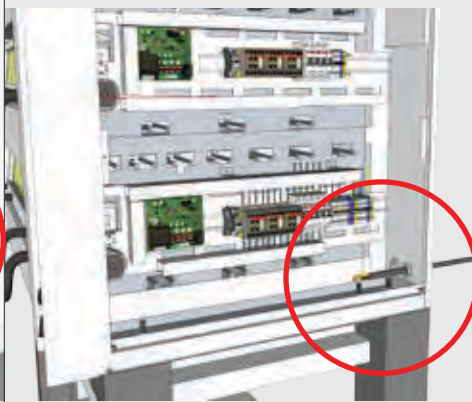

2. Take the power supply cable (depending on voltage the oven can be connected with 1 power supply per deck or 1 power supply per oven, power supply cable(s) is not included) through the hole(s) on the backside right-hand side of the oven and further to the connecting terminal. An adequate restraining must be used for each power supply cable.



3. Following the appropriate electrical wiring diagram confirming to the oven rating plate, connect the power supply leads to the field terminal block.

Make sure all connections are tight, then place back the right-hand side panel.

PM 700 Series

AMPS per phase and DECK (1) or OVEN (2) for ovens with – Power Guard, see (3) – Door Opener, see (4)

Model	230V 1ph + N		400V 3ph + N		480V 3ph + N		230V 3ph / 400V 3ph + N		200V 3ph	208V 1ph	208V 3ph	240V 1ph	240V 3ph	400V 3ph		460V 3ph (440-480)	
	(1)	(2)	(1)	(2)	(1)	(2)	230V 3ph	400V 3ph + N	(1)	(1)	(1)	(1)	(1)	(1)	(2)	(1)	(2)
PM 721		9.3		7.8		9.3								9.3			8.1
PM 722		18.6		14.9		18.6								18.6			16.1
PM 723	27.7	27.9	7.8	22.4	16.2	27.9	9.3	30.6	17.2	17.9	17.9	28.9	16.9	9.3	8.1	24.2	
PM 724		27.9 + 9.3		22.4 + 7.8		27.9 + 9.3								27.9 + 9.3			24.2 + 8.1
PM 725		27.9 + 18.6		22.4 + 14.9		27.9 + 18.6								27.9 + 18.6			24.2 + 16.1
PM 731		13.9		11.6		13.9								13.9			12.0
PM 732		27.8		23.1		27.8								27.8			24.1
PM 733	41.2	41.7	11.6	34.7	24.1	41.7	13.9	45.6	25.6	26.6	26.6	43.3	25.1	13.9	12.0	36.1	
PM 734		41.7 + 13.9		34.7 + 11.6		41.7 + 13.9								41.7 + 13.9			36.1 + 12.0
PM 735		41.7 + 27.8		34.7 + 23.1		41.7 + 27.8								41.7 + 27.8			36.1 + 24.1
PM 741		18.5		15.4		18.5								18.5			16.0
PM 742		37.0		30.8		37.0								37.0			32.1
PM 743	54.8	55.6	15.4	46.1	32.1	55.6	18.5	60.6	34.1	35.5	35.5	57.2	33.5	18.5	16.0	48.1	
PM 744		55.6 + 18.5		46.1 + 15.4		55.6 + 18.5								55.6 + 18.5			48.1 + 16.0
PM 745		55.6 + 37.0		46.1 + 30.8		55.6 + 37.0								55.6 + 37.0			48.1 + 32.1

(1) Amps per phase and deck with 1 power supply cable per oven deck.

(2) Amps per phase and oven with 1 power supply cable per oven, up to 3 deck. If 4 and 5 deck, 2 power supply cables per oven is required.

(3) Power Guard reduce ovens Amp draw. Calculate sec. deck as 0 A. Simultaneously used master / sec. decks reduce the sec. decks capacity.

(4) Door Opener require 1 separate 3ph (208/230/400/480) supply. Supplies up to 5 deck. Amp draw 1 A / deck / phase.



CANADA VERSION - Only 1 power supply cable, up to 120 A per oven can be used. For Amp draw over 120 A use Power Guard option.

PM 800 Series

AMPS per phase and DECK (1) or OVEN (2) for ovens with – Power Guard, see (3) – Door Opener, see (4)

Model	230V 1ph + N		400V 3ph + N		480V 3ph + N		230V 3ph / 400V 3ph + N		200V 3ph	208V 1ph	208V 3ph	240V 1ph	240V 3ph	400V 3ph		460V 3ph (440-480)	
	(1)	(2)	(1)	(2)	(1)	(2)	230V 3ph	400V 3ph + N	(1)	(1)	(1)	(1)	(1)	(1)	(2)	(1)	(2)
PM 821		13.1		10.9				13.1							13.1		11.4
PM 822		26.1		21.7				26.1							26.1		22.6
PM 823	39.2	39.1	10.9	32.5			22.6	13.1	24.0	43.3	25.0	40.9	23.7	13.1	39.1	11.4	33.9
PM 824		39.1 + 13.1		32.5 + 10.9				39.1 + 13.1							39.1 + 13.1		33.9 + 11.4
PM 825		39.1 + 26.1		32.5 + 21.7				39.1 + 26.1							39.1 + 26.1		33.9 + 22.6
PM 831		19.6		16.2				19.6							19.6		16.9
PM 832		39.1		32.5				39.1							39.1		33.9
PM 833	58.6	58.7	16.2	48.7			33.9	19.6	36.0	–	37.5	61.2	35.4	19.6	58.7	16.9	50.8
PM 834		58.7 + 19.6		48.7 + 16.2				58.7 + 19.6							58.7 + 19.6		50.8 + 16.9
PM 835		58.7 + 39.1		48.7 + 32.5				58.7 + 39.1							58.7 + 39.1		50.8 + 33.9
PM 841		24.7		20.5				24.7							24.7		21.4
PM 842		49.3		41.0				49.3							49.3		42.7
PM 843	–	74.0	20.5	61.5			42.7	24.7	45.4	–	47.3	–	44.6	24.7	74.0	21.4	64.1
PM 844		74.0 + 24.7		61.5 + 20.5				74.0 + 24.7							74.0 + 24.7		64.1 + 21.4
PM 845		74.0 + 49.3		61.5 + 41.0				74.0 + 49.3							74.0 + 49.3		64.1 + 42.7

(1) Amps per phase and deck with 1 power supply cable per oven deck.

(2) Amps per phase and oven with 1 power supply cable per oven, up to 3 deck. If 4 and 5 deck, 2 power supply cables per oven is required.

(3) Power Guard reduce ovens Amp draw. Calculate sec. deck as 0 A. Simultaneously used master / sec. decks reduce the sec. decks capacity.

(4) Door Opener require 1 separate 3ph (208/230/400/480) supply. Supplies up to 5 deck. Amp draw 1 A / deck / phase.



CANADA VERSION - Only 1 power supply cable, up to 120 A per oven can be used. For Amp draw over 120 A use Power Guard Option.

PM 900 Series

AMPS per phase and DECK (1) or OVEN (2) for ovens with – Power Guard, see (3) – Door Opener, see (4)

Model	230V 1ph + N		400V 3ph + N		480V 3ph + N		230V 3ph / 400V 3ph + N		200V 3ph	208V 1ph	208V 3ph	240V 1ph	240V 3ph	400V 3ph		460V 3ph (440-480)	
	(1)	(2)	(1)	(2)	(1)	(2)	230V 3ph	400V 3ph + N	(1)	(1)	(1)	(1)	(1)	(1)	(2)	(1)	(2)
PM 911		11.2		9.3				11.2						11.2			9.7
PM 912		22.2		18.4				22.2						22.2			19.2
PM 913	33.4	33.3	9.3	27.6	19.2	11.2		33.3	20.5	36.9	21.4	34.8	20.2	33.3	9.7	28.8	
PM 914		33.3 + 11.2		27.6 + 9.3				33.3 + 11.2						33.3 + 11.2			28.8 + 9.7
PM 915		33.3 + 22.2		27.6 + 18.4				33.3 + 22.2						33.3 + 22.2			28.8 + 19.2
PM 921		15.9		13.2				15.9						15.9			13.7
PM 922		31.7		26.4				31.7						31.7			27.5
PM 923	47.6	47.6	13.2	39.5	27.5	15.9		47.6	29.2	52.7	30.4	49.7	28.7	47.6	13.7	41.2	
PM 924		47.6 + 15.9		39.5 + 13.2				47.6 + 15.9						47.6 + 15.9			41.2 + 13.7
PM 925		47.6 + 31.7		39.5 + 26.4				47.6 + 31.7						47.6 + 31.7			41.2 + 27.5
PM 931		24.5		20.3				24.5						24.5			21.1
PM 932		48.9		40.6				48.9						48.9			42.4
PM 933	-	73.4	20.3	60.9	42.4	24.5		73.4	45.0	-	46.8	-	44.2	73.4	21.1	63.5	
PM 934		73.4 + 24.5		60.9 + 20.3				73.4 + 24.5						73.4 + 24.5			63.5 + 21.1
PM 935		73.4 + 48.9		60.9 + 40.6				73.4 + 48.9						73.4 + 48.9			63.5 + 42.4
PM 941		31.0		25.7				31.0						31.0			26.8
PM 942		62.0		51.4				62.0						62.0			53.7
PM 943	-	92.9	25.7	77.1	53.7	31.0		92.9	57.0	-	59.3	-	56.0	92.9	26.8	80.5	
PM 944		92.9 + 31.0		77.1 + 25.7				92.9 + 31.0						92.9 + 31.0			80.5 + 26.8
PM 945		92.9 + 62.0		77.1 + 51.4				92.9 + 62.0						92.9 + 62.0			80.5 + 53.7

(1) Amps per phase and deck with 1 power supply cable per oven deck.

(2) Amps per phase and oven with 1 power supply cable per oven, up to 3 deck. If 4 and 5 deck, 2 power supply cables per oven is required.

(3) Power Guard reduce ovens Amp draw. Calculate sec. deck as 0 A. Simultaneously used master / sec. decks reduce the sec. decks capacity.

(4) Door Opener require 1 separate 3ph (208/230/400/480) supply. Supplies up to 5 deck. Amp draw 1 A / deck / phase.



CANADA VERSION - Only 1 power supply cable, up to 120 A per oven can be used. For Amp draw over 120 A use Power Guard option.

Installation – Evacuation connection

Evacuation connection

The oven is designed to be connected to an extraction system. The capacity of the extractor depends on the number of decks per oven. An extraction capacity of 200 m³/h (115 CFM) per oven deck is recommended for each alternative below. The oven has two provided exhaust outlets, each Ø100 mm (Ø4 inch). One at the front to evacuate air from the steam duct and one at the back to evacuate air from the oven chamber.

Evacuation Connection



Extractor hood (Recommended Option)

If an extractor hood is placed above the oven, it is not necessary to connect the exhaust outlets. The hood should be approx. 0,5 m (20 inch) larger than the outer edge of the oven to effectively cope with steam, smoke and fumes from the oven.



Exhaust outlets

To prevent steam, smoke and fumes from the oven being channelled out into the room, the exhaust outlets should be connected as illustrated



IMPORTANT!

Local inspectors, ventilation- and environmental specialists should be consulted so that the design and the installation conforms to local regulations.



Flue Diverter

Make sure that the flue diverter is connected firmly to the oven



Flue diverter air circulation

Regardless of the connection, the flue diverter base needs to be open at all times



WARNING!

DO NOT place any object blocking the ventilation. this affects the baking, oven performance and may cause fire

Steam System Installation

Important!

- Particle filter must be installed on incoming water line.
- Water softener is recommended to install on incoming water line.

Important!

Guidelines for water quality:

- Magnesium, Mg (<30 mg/l)
- Calcium, Ca (20 – 100 mg/l)
- Hardness, dH (4,0 – 7,0 dH)
- pH at 20°C (7,5 – 8,5 pH)
- Alkalinity, HCO₃ (>60 mg/l)

Steam System Installation



Your oven can be equipped with an optional Steam System in 1 or more decks

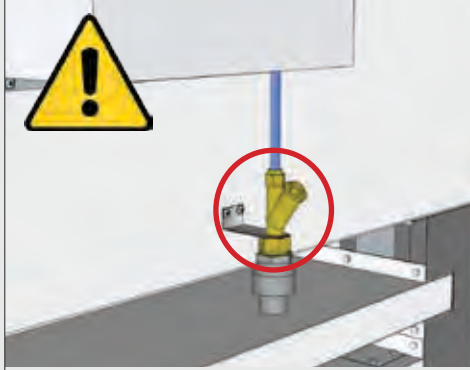

This appliance must be installed with a proper backflow protection system by an authorized personnel



Incoming water pressure must not exceed 6.0 bar (0,6 MPA)



If incoming water pressure is above 6.0 bar (0.6 MPA) a Water Pressure Reducing Valve must be installed



Read carefully the instructions on the label attached to the steam system

2 Make sure that the Blue Knobs are at the minimum position by turning the knob in (-) negative direction

3 Connect the hose and open the Air Relief Valve, turn on the water supply and let water flow through the valve and close it.

4 With the water supply open, set water pressure on all decks with the pressure marked below by gradually increasing the pressure by turning the Blue Knob regulator in (+) positive direction:

- 1,4 bar (0,14 MPA)
- 1,6 bar (0,16 MPA)
- 1,8 bar (0,18 MPA)

5 Test Steam System 2 times per deck to assure that correct water pressure has been achieved

The label indicates the water pressure that the system needs to be adjusted to



1. Make sure that the Blue Knobs are at the minimum position by turning the knob in (-) negative direction



2. Open the water supply and let water run, this will clean the hose and any other residue in the water system before connecting the water supply to the Steam System



3. Connect the hose to the oven

Steam System Installation and Use



4. Open the Air Relief Valve



5. Turn ON the water and let water flow through the valve and then close the Air Relief Valve



6. Set the water to the pressure marked on the label by turning slowly the Blue Knob regulator in the (+) positive direction.
* Repeat for all decks



7. Turn ON the oven and set the temperature to 220 C (428 F). The Steam Button will light up to show that the system is ready (15 minutes after the oven has reached 200 C (392 F))

Press the Steam Button to produce steam inside the deck



8. The Steam System needs 12 minutes to reload.

Test the Steam System 2 times per deck to assure that correct water pressure has been achieved

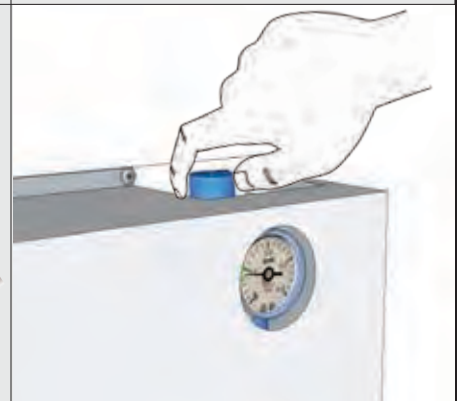

9. Adjust the Steam System if necessary

Use



1. At first start when the oven reach 200 C (392 F), the steam system takes 15 minutes to get ready



2. After the 15 minutes, the Steam Button lights as a signal that the system is ready to be use. Press and release the button at anytime



3. The button light turns off and waits 12 minutes to get ready one more time

UBC

Every PizzaMaster® oven can be equipped with a highly versatile underbuilt cabinet as an optional extra. The shelf supports and dividers in the cabinet can be adjusted almost infinitely, so that you can exploit the storage space optimally and use different sizes of tray pizza pans at the same time. The PizzaMaster® underbuilt cabinet can also be supplied as a proving cabinet (UBC-P)



Underbuilt cabinet

Model	Internal dimensions Width x Depth x Height		Power output kW
	Millimetres	Inches	
UBC 720	850 x 715 x 510	33,5 x 28,2 x 20,1	1.0
UBC 730	1205 x 715 x 510	47,5 x 28,2 x 20,1	1.0
UBC 740	1560 x 715 x 510	61,5 x 28,2 x 20,1	1.0
UBC 820	975 x 835 x 510	38,5 x 32,9 x 20,1	1.0
UBC 830	1385 x 835 x 510	54,6 x 32,9 x 20,1	1.0
UBC 840	1795 x 835 x 510	70,7 x 32,9 x 20,1	1.0
UBC 920	1075 x 935 x 510	42,3 x 36,8 x 20,1	1.0
UBC 930	1535 x 935 x 510	60,4 x 36,8 x 20,1	1.0
UBC 940	1995 x 935 x 510	78,6 x 36,8 x 20,1	1.0

Important!

For reasons of safety and the validity of the warranty, all electrical work must be carried out by a qualified electrician.

Information!

UBC-P (underbuilt proofer) is not available for US and Canada markets. Only standard cabinet UBC is available for US and Canada.

Information!

UBC not available in combination with 4 and 5 deck ovens.

Lower un-loading shelf not available on oven equipped with UBC.

Upper un-loading shelf not available on 3 deck oven equipped with UBC.



UBC Assembly

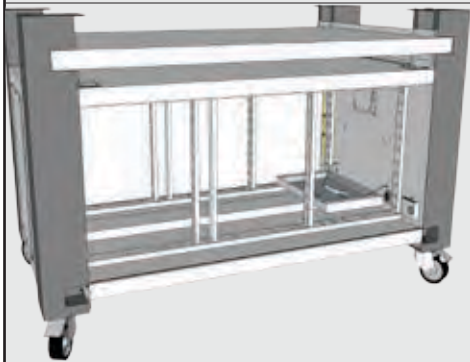

1. Starting from inside the cabinet. The unique and smart design makes it possible to adjust both the width and the height inside the cabinet, to fit your exact needs.

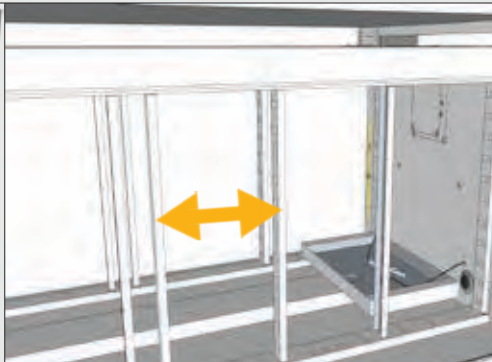

2. Fit the dividers



3. Fit the supports



4. Fit the glass-doors to the cabinet. The number of glasses depend of the size of your UBC.



Electrical connection
(only for UBC-P)

Feed the electrical wires and the protective plastic tube through the access hole in the bottom of the oven. Then connect the electrical wires to the oven, see attached Technical description and the Electrical diagram.

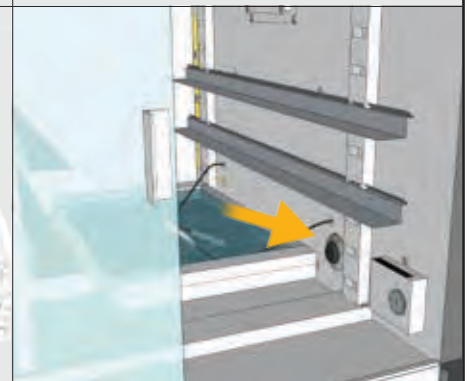

Factory settings (UBC-P)
Temperature: 38 C (100 F)
Humidity: 78%

Available temperature settings:
room temperature - 50 C (122 F)

Tip! for best fermentation result the factory settings should not be changed. If slower fermentation is required lower the temperature slightly.

UBC-P Use

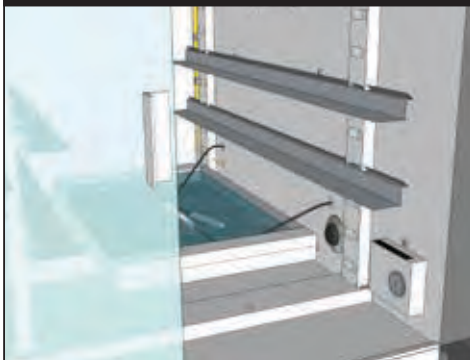

1. Place the two water heaters in the container, fill with water until the heaters are cover with water approximately 1cm (1/2'')

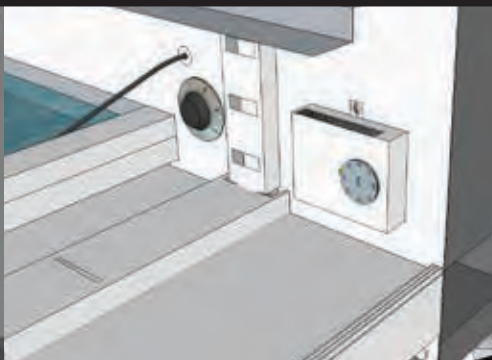

2. Set Temperature and humidity.
Recommendation! for best fermentation result factory settings should be used (see above)



3. Turn ON/OFF (Main Switch)
1 = On
0 = Off

Automatic door opener

All oven doors in the PizzaMaster 700, 800 and 900 series can be equipped with an automatic door opener as an optional extra.

Each automatic door opener has a powerful 3-phase motor that open or close the oven door alternately by each press on the foot pedal.



This enables the baker to have both hands free when loading or un-loading the oven. It also relieves the arms and shoulders from the stress of opening the oven door manually many many times during a working day.

The door opener has a mechanical safety clutch that enables the oven door to be opened manually at all times.

Important!

For reasons of safety and the validity of the warranty, all electrical work must be carried out by a qualified electrician.

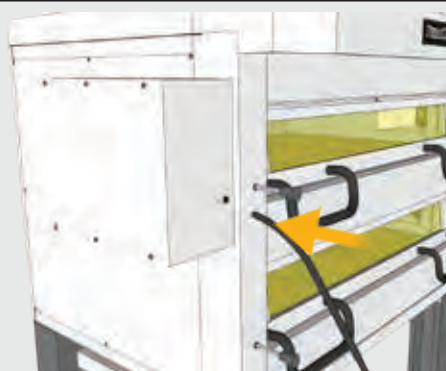
The automatic door opener must be connected via an external main switch with min. 3 mm gap.

		
<p>1. Connect the foot pedals air hose at the front of the door opener, secure the hose with the provided cable tie (do not tighten too hard, air must flow through the hose to the air-switch inside the box).</p>	<p>2. Place the foot pedal at a suitable place on the floor.</p>	<p>Open the side panel to access door opener system to make the electrical connection</p>

Electrical installation

The door opener requires a separate 3-phase 10A electrical connection. Only one electrical connection is necessary for up to 5 oven doors.

1. Make sure electrical supply corresponds with that specified on the oven rating plate (separate rating plate located on backside of the lowest door opener box)
2. Remove the screws (10 pcs) that secures the lowest door openers side panel, and take off the panel.
3. Feed the power supply cable(s) (provided by customer) through the access holes on the right-hand back of the door opener box and pull the cable to the field terminal block.
4. Following the appropriate electrical wiring diagram confirming to the oven rating plate, connect the power supply leads to the field terminal block.
5. Make sure all connections are tight, then replace the right-hand side panel.

The earth potential equalizer screw has to be installed. The earth potential screw is located on the backside next to the connecting cable.



Digital Control Panel

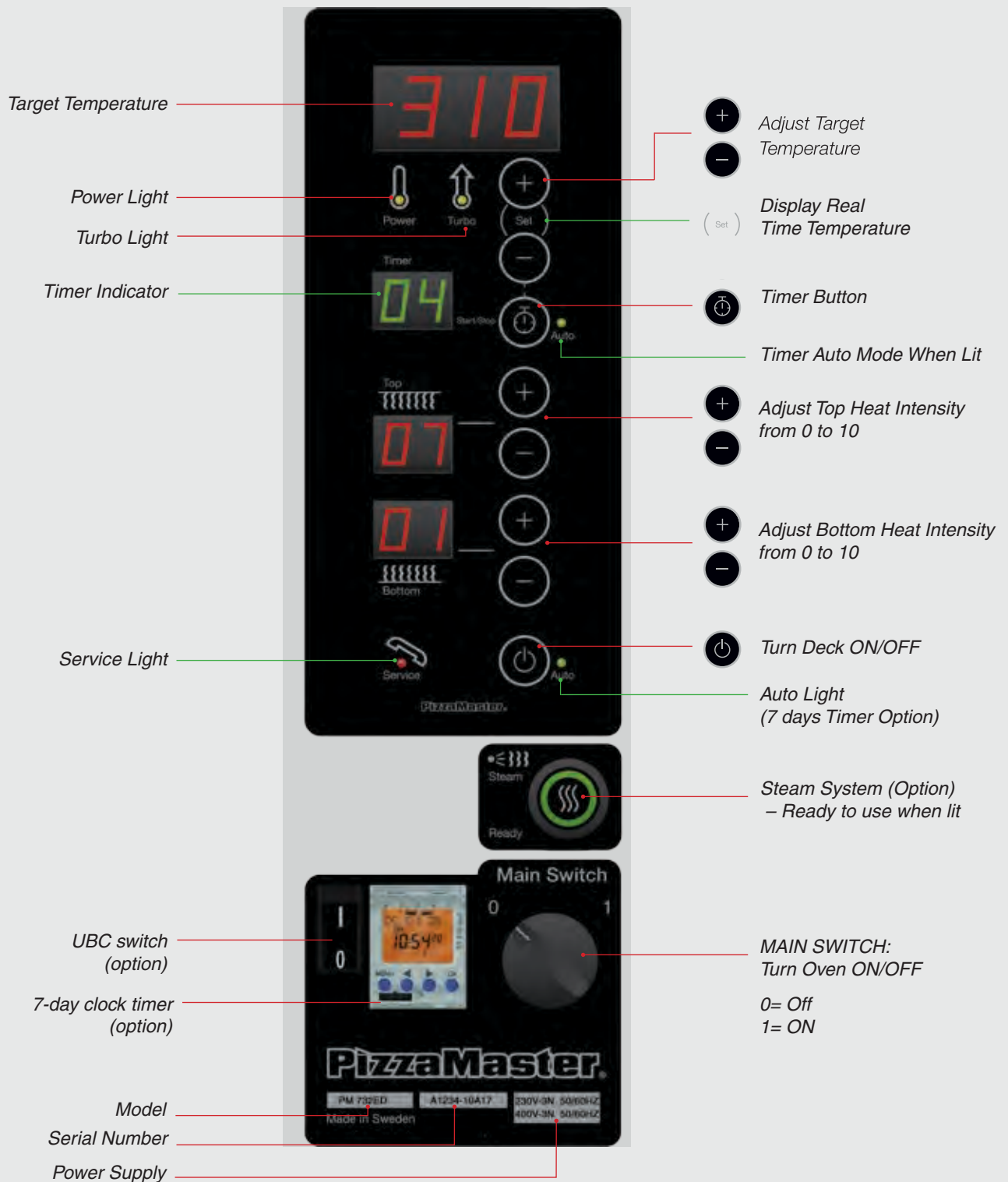

Power : A yellow lamp indicates that the heating element is on.

Turbo: The turbo-start function, engaged automatically at start up, brings the oven up to temperature very quickly. When the desired temperature has been reached, the turbo-start shuts off automatically. A yellow lamp indicates that the turbo is in operation.

Service: If the oven overheats, it is turned off automatically. A red light will show when the overheating cut-off has been activated. The oven can be reset by turning off the main switch and turn it on again, when the temperature have gone down below 390 °C / 734 °F (for standard model), 490 °C / 914 °F (for high temperature model).

Operation Guide



Every deck has an independent Control Panel.



1. Turn ON the oven
Place the Main Switch to position "1" to turn ON the oven.



2. Turn ON the deck
Press to turn ON every deck.



3. Set Temperature
Press to adjust the desired temperature.

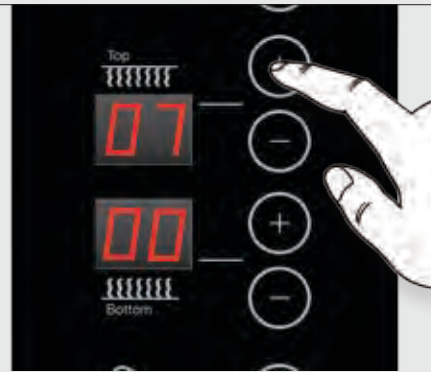

4. Set Top Heat Zone
Press to adjust the TOP heat intensity:
0 = Off / 10 = Maximum

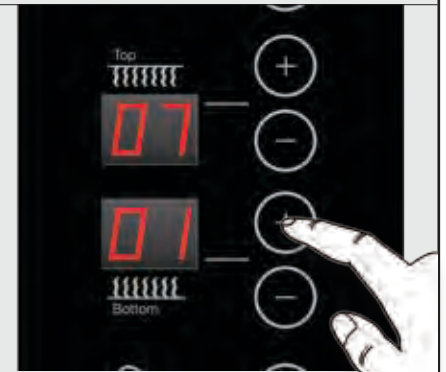

5. Set Bottom Heat Zone
Press to adjust the BOTTOM heat intensity:
0 = Off / 10 = Maximum



6. Real Time Temperature
Press and hold SET button to display the decks actual temperature at any time



7. Turn "OFF" the deck
Press to turn OFF the deck.



8. Turn OFF the oven
Place the Main Switch to position "0" to turn OFF the oven.

Individual Baking Times - Normal Mode

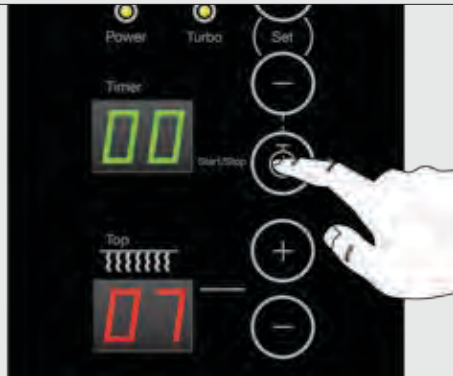

1. Turn ON Timer
Press Timer button



2. Set Time
Press to adjust the desire baking time (minutes)

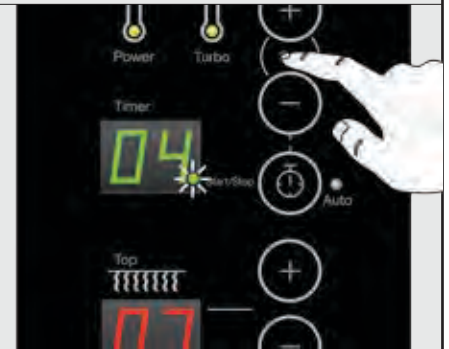

3. Confirm
Press SET button to confirm. A green indication light is turned on in the timers display



4. Start Timer
Press Timer button to START timer. The green light is flashing and remaining time is showed



5. PAUSE / STOP
Press Timer to PAUSE time. Press Timer and SET to STOP



6. Alarm
An alarm comes on when the time has passed, count down comes to 0 (zero)



7. Shutting Off the Alarm
Press Timer button to Shut off the alarm

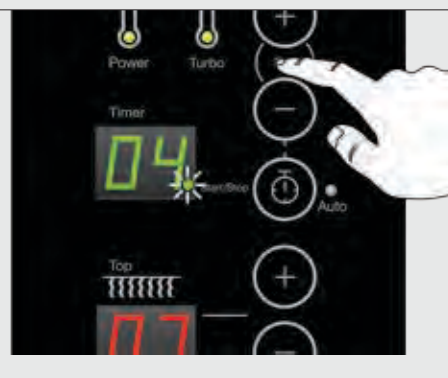

8. Finish
Press SET button to finish. The green indication light is turned on in the timers display

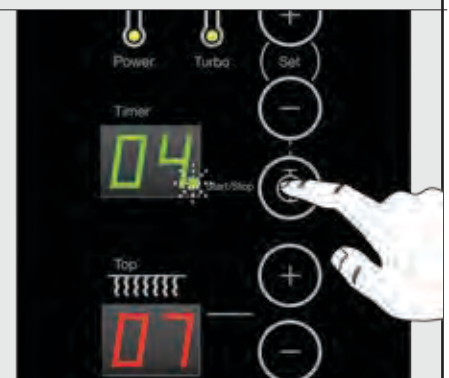

9. Repeat the cycle
Press Timer button to repeat the cycle. The green indication light will flash



Common Baking Time - Auto Mode

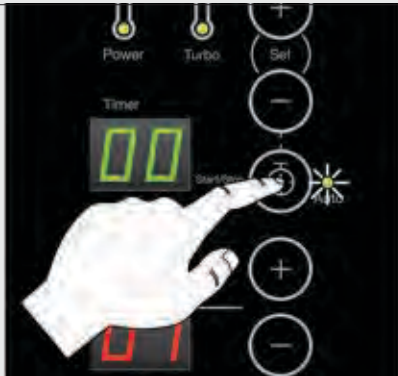

1. Turn ON timer
 Press and hold Timer button until the green Auto lamp is turned On



2. Set Time
 Press to adjust the desired baking time (minutes)

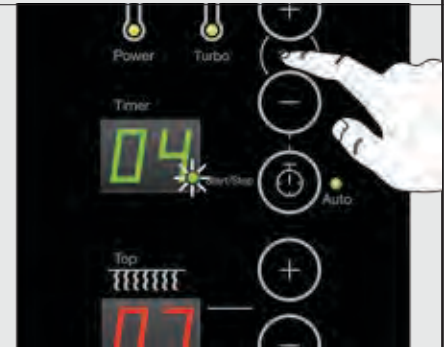

3. Confirm
 Press SET button to confirm. A green indication light is turned on in the timers display



4. Start Timer
 Press Timer button to START timer. The green light will flash



5. Five (5) independent Alarms
 Up to 5 independent alarms can be activated. Press Timer button for each one of them



6. Alarm
 After desired baking time, the oven gives a 3 second alarm for every preset time



6. New Alarm
 You can add a new alarm as soon as another alarm has finished, press Timer to set the new time

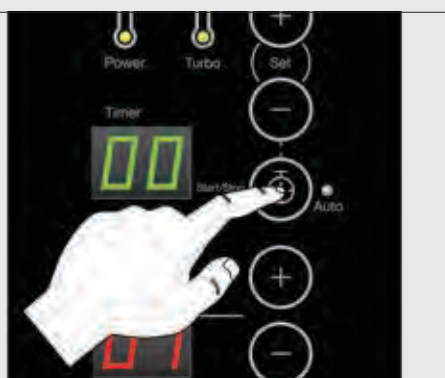

7. Turn "OFF" Timer
 Hold Timer until the light goes off, and press SET to turn OFF the timer



8. Repeat
 To replay, press and hold Timer button until the green Auto lamp is Turned On

Top Front Setting

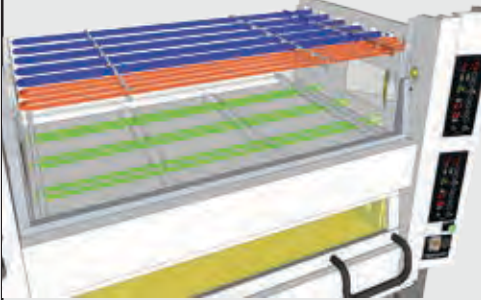

HEAT ZONES

The oven has 3 independent heat zones, Bottom, Top and Top Front. Top Front is adjustable between 0 to +4 for the Top heat setting

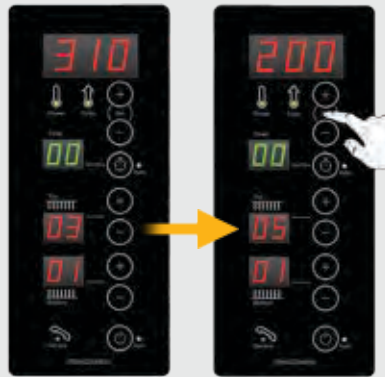

1. Top Front Setting

(Set) Press SET to see the Top Front setting and the actual temperature.



2. Factory Settings

Pizza Deck: +2
Bakery Deck: 0



3. To Configure

Turn OFF the oven from the Main Switch



4. Press Set

(Set) Press SET and hold it



5. Turn ON the Oven

(Set) Hold SET and Turn ON the oven from the Main Switch



6. Top Front Settings

(+) (-) Press to adjust the Top Front settings from 0 to 4



7. Press SET

(Set) Press SET to finish the configuration

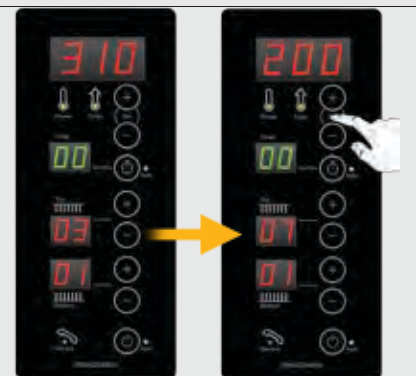

8. Check

(Set) Press SET at any time to see the Top Front Settings

Classic Control Panel

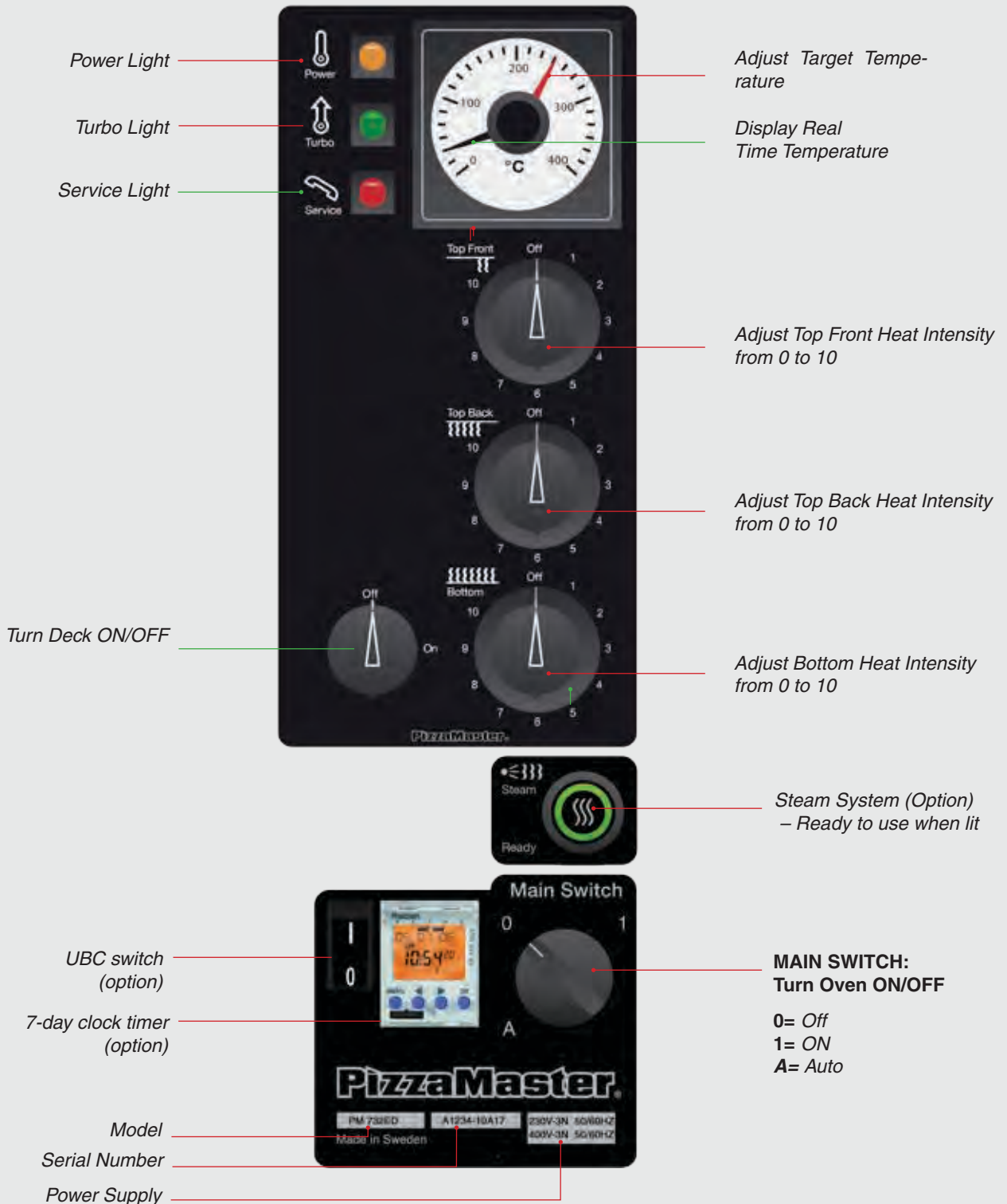

Power : A yellow lamp indicates that the heating element is on.

Turbo: The turbo-start function, engaged automatically at start up, brings the oven up to temperature very quickly. When the desired temperature has been reached, the turbo-start shuts off automatically. A yellow lamp indicates that the turbo is in operation.

Service: If the oven overheats, it is turned off automatically. A red light will show when the overheating cut-off has been activated. The oven can be reset by turning off the main switch and turn it on again, when the temperature have gone down below 390 °C / 734 °F (for standard model), 490 °C / 914 °F (for high temperature model).

Classic Control Panel



1. Turn ON the oven
Place the Main Switch to position "1" to turn ON the oven



2. Turn ON the deck
Turn the knob to ON position



3. Set Temperature
Rotate the knob to modify the desire temperature

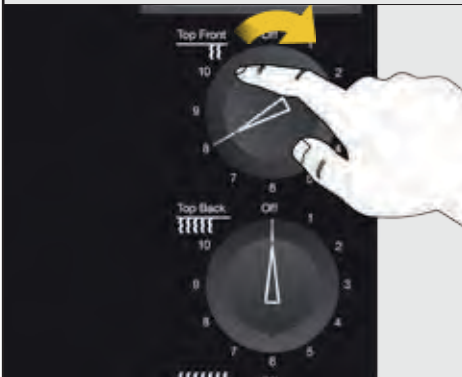

4. Set the Top Front Heat Zone
Rotate to adjust the Top Front Heat intensity.
0 = Off / 10 = Maximum

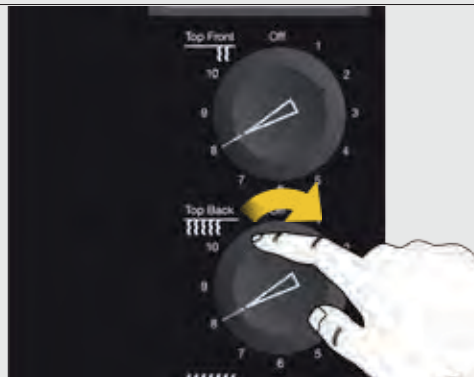

5. Set the Top Back Heat Zone
Rotate to adjust the Top Back Heat intensity.
0 = Off / 10 = Maximum



6. Set the Top Bottom Heat Zone
Rotate to adjust the Bottom Heat intensity.
0 = Off / 10 = Maximum



7. Real time temperature indicator
Check the "Black" Indicator to know the Real Temperature at anytime

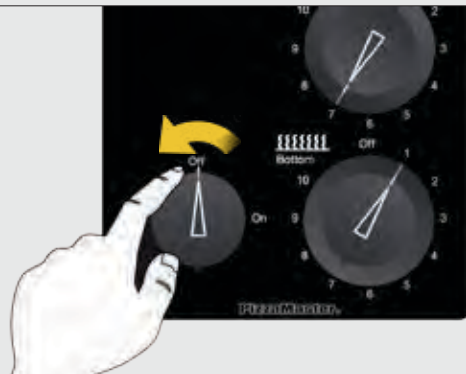











8. Turn "OFF" the deck
Rotate to turn OFF the deck





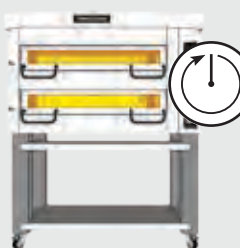

9. Turn OFF the oven
Place the Main Switch to position "0" to turn OFF the oven

*First Time Start-Up

 <p>You must Burn Off any remaining protective oil. This process will emit certain amount of smoke, which is normal.</p>	 <p>1. Turn ON External Ventilation Turn ON the hood or any ventilation system and open any near windows.</p>	 <p>2. Open Oven Ventilation Pull out the ventilation handle.</p>	 <p>3. Turn ON the Oven Turn ON the oven from the Main Switch.</p>
 <p>4. Turn ON every Oven Deck Press ON/OFF button in every deck to turn them ON.</p>	 <p>5. Set Temperature in 350°C (662°F) Press the buttons to set the oven 350°C (662°F)</p>	 <p>6. Set Top Heat Zone Press the button to adjust the Top Heat intensity: 10 in every deck.</p>	 <p>7. Set Bottom Heat Zone Press the button to adjust the Bottom Heat intensity: 10 in every deck.</p>
 <p>8. Real Time temperature Press and hold SET button at any time to display the deck's actual temperature.</p>	 <p>9. Wait 60 Minutes When the oven reaches 350°C (662°F), you must wait 60 minutes.</p>	 <p>10. Smoke Let all the smoke go out from the oven.</p>	 <p>Congratulations! Now your oven is ready to use!</p>

*Note: Use the same configuration for a Classic Control Panel model.

*How to use

Digital Panel	
 <p>1. To activate the Timer in a Digital panel</p>	 <p>2. Place Main Switch in position 1, press and hold Deck ON/OFF button until the green lamp is turned on</p>
Classic Panel	
 <p>1. To activate the Timer in a Classic panel</p>	 <p>2. Place the Main Switch in A position</p>

*Note: The Timer is not configured from factory. You need to follow "Timer Set Up" and "Program Set Up" steps before first use.

Tip/Example

1. Before starting to program, write down your Start and Stop Times	2. START: Set the start 45 minutes before opening	3. STOP: Set the stop 15 minutes after closing	4. Example: Observe the example below				
Weekday	Monday	Tuesday	Wednesday	Thursday	Friday	Saturday	Sunday
Open Hours	11.00 - 21.00	11.00 - 21.00	11.00 - 21.00	11.00 - 22.00	11.00 - 22.00	12.00 - 22.00	12.00 - 20.00
Suggested Start / Stop Times	10:15 - 21:15	10:15 - 21:15	10:15 - 21:15	10:15 - 22:15	10:15 - 22:15	11:15 - 22:15	11:15 - 20:15

Timer Set Up

Oven Status:
 - ON : Oven Operating
 - OFF : Oven Inoperating

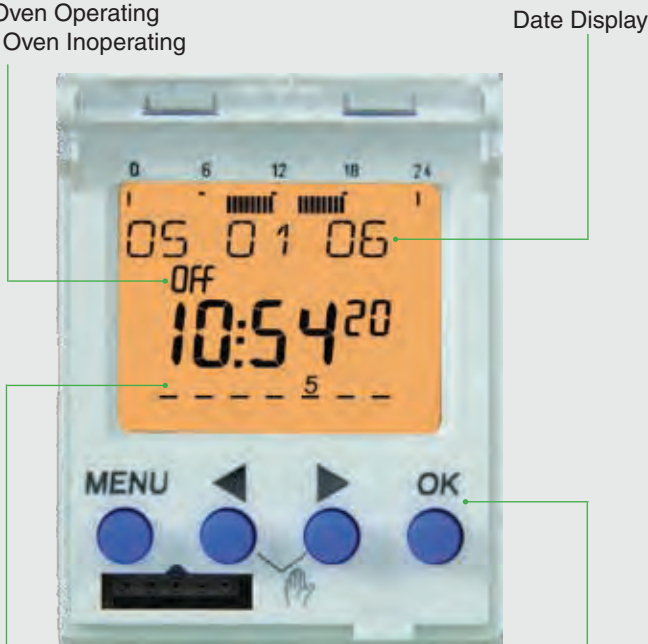

Current Weekday:
 1= Monday, 2= Tuesday;
; 7= Sunday



1. Select language by pressing or and confirm with OK



2. Press OK to configure Form Date



3. Select Date format by pressing or and confirm with OK



4. Select Year by pressing or and confirm with OK



5. Select Month by pressing or and confirm with OK



6. Select Day by pressing or and confirm with OK



7. Press OK to configure Form Time



8. Select Time display format by pressing or and confirm with OK



9. Configure hour by pressing or and confirm with OK



10. Configure minute by pressing or and confirm with OK



11. Configure Summer or Winter time by pressing or and confirm with OK



Now your timer is configured

Program Set Up



1. Press **MENU** Menu to program ON-OFF time, confirm with **OK**



2. Press **OK** OK to configure new program



3. Press **left arrow** or **right arrow** to program ON or OFF times and confirm with **OK** OK



4. Select ON Hour by pressing **left arrow** or **right arrow** and confirm with **OK** OK



5. Select ON minutes by pressing **left arrow** or **right arrow** and confirm with **OK** OK



6. Select day by pressing **left arrow** or **right arrow** and confirm with **OK** OK



7. Press **OK** OK to Copy to another day(s). Press **left arrow** or **right arrow** to Save. Repeat steps 2 to 7 for individual day times



8. Select days with **left arrow** or **right arrow** and confirm with **OK** OK



9. Press **OK** OK to Save



10. Press **OK** OK to configure new program



11. Press **left arrow** or **right arrow** to program ON or OFF times and confirm with **OK** OK



12. Select OFF Hour by pressing **left arrow** or **right arrow** and confirm with **OK** OK



13. Select OFF minutes by pressing **left arrow** or **right arrow** and confirm with **OK** OK



14. Select day by pressing **left arrow** or **right arrow** and confirm with **OK** OK



15. Press **OK** OK to Copy to another day(s). Press **left arrow** or **right arrow** to Save. Repeat steps 10 to 15 for individual day times



16. Select days with **left arrow** or **right arrow** and confirm with **OK** OK. Save after pressing **OK** OK

Clear Programs



1. *Press **MENU** Menu to start



2. Press **◀** or **▶** until you find Delete and confirm with **OK** OK



3. Press **◀** or **▶** to select Single or Delete All (Step 5). Press **OK** OK to delete Single program



4. Press **◀** or **▶** to select Single program. Press **OK** OK to delete it



5. Select Delete All by pressing **◀** or **▶** and confirm with **OK** OK



6. Press **OK** OK to delete all the programs



7. Deleted confirmation is showed



8. Press **ESC** ESC one time to go to Program menu, or two times to Exit

*Note: Use "Clear Programs" to remove one or all the ON or OFF programs. You need to follow steps "Program Set Up" after this.

Factory Reset



1. *Press **MENU** Menu, press **◀** or **▶** until you find Options menu and confirm with **OK** OK



2. Press **◀** or **▶** until you find Factory Settings and confirm with **OK** OK



3. Press **OK** OK to reset completely the timer



4. Go to TIMER SET UP steps to configure the timer

*Note: Use "Factory reset" to remove all the data. You need to follow steps "Timer Set Up" and "Program Set Up" after this.

Pizza Recipe / Oven Settings / Baking Guidelines

Pizza Recipe and Baking Temperature

Pizza Dough Recipe

Flour (*bakers % = 100)

Always use a high quality flour (double zero (00) preferably an Italian brand as quality is higher and more consistent)

Water (*bakers % = 65)

Salt (*bakers % = 3)

Yeast Fresh, (*bakers % = 1) or Dry (equivalent to fresh yeast as recommended by producer)

Baking Temperature (classic margarita pizza)

290 C / 554 F = 4min 10sec (change water to 50% change salt to 1.5%, add sugar with 1.5%, add oil with 3.5%)

310 C / 590 F = 3min 40sec (change water to 50% change salt to 1.5%, add sugar with 1.5%, add oil with 3.5%)

330 C / 626 F = 3min 20sec (change water to 55% change salt to 2%, add sugar with 1%, add oil with 3.5%)

350 C / 662 F = 2min 50sec (change water to 60% change salt to 2.5%, add sugar with 0.5%, add oil with 3.5%)

370 C / 698 F = 2min 30sec (baking at this temperature or higher we recommend our high temperature model)

400 C / 752 F = 2min 10sec

430 C / 806 F = 1min 50sec (at this temperature or higher the pizza "positively dry out" as most of the fluids vaporize)

460 C / 860 F = 90sec (5sec at this temperature or higher can make the difference between failure and success)

490 C / 914 F = 60sec

Oven Settings

Important!

- Always bake Pizza with the ovens ventilation open
- Never set the Top Heat lower than 3
- Use the entire oven deck by rotating the placement of the pizzas (never have a favourite spot in the oven)
- Standard setting for Top Front is (+2 for Pizza, +0 for Bread and to Roast/Bake/Grill Food), see page 28.

Pizza baked direct on stone

Temperature See above recipe

Top 6-8

Bottom 0-3

Pizza baked in Pan or on Grid

Temperature See above recipe

Top 3-5

Bottom 6-10

Roast/Bake/Grill Food

Temperature 180-220 C (355-430 F)

Top 5

Bottom 5

Bread

Temperature Japanese/Asian bread 160-190 C (320-375 F)

European bread 200-240 C (390-465 F)

Top 4

Bottom 6

If you require further baking guidance contact your local PizzaMaster representative or PizzaMaster directly.

Dough Preparation

Important!

Use cold water (this is important for having a uniform result) if using room temperature water the fermentation process starts and you will have less control over the fermentation.

1. Put water into mixer and thereafter dissolve the yeast in water. Put in salt and 75% of the flour.
2. Mix on lowest speed for 3min (depending on mixer the time can vary, the dough should be completely blended).
3. Start the mixer again on slowest speed.
4. After 5min start to add the remaining flour gradually.
5. Increase speed after 8min.
6. Stop mixing after 15min and let the dough rest for 20min.
7. Take out the dough from the mixer and put it on a floured surface and cut into balls (fro 33cm 310gr)
8. Place the dough balls in plastic boxes with airtight lids.
9. If the dough is wet it can be “sticky” put a little (very little) olive oil on the dough and your hands to make dough handling easier.
10. Store cold for 2-3 days (for the very best result reshape doughballs every 24 hours)

Making the Pizza

1. Take out the dough from the fridge 90min before baking
2. If having a very light or wet dough it can be easier to use a wooden peel and/or open the pizza directly on the peel.
3. For easier dough handling always use plastic tools when working with the dough.
4. Use as little flour as possible when “opening” the pizza dough and always shake off excess flour.

Recommendations

- Use only, for the tomato sause, canned whole tomatoes of good quality, remove all hard parts from the tomatoes.
- Use buffalo mozzarella, dry the mozzarella as much as possible (tip is to put flaked sea salt on mozzarella 5-10min before use)
- Add extra virgin olive oil on pizza before putting it into oven for extra taste
- Do not use too much topping on pizza as this “kills” the dough
- Do not use wet toppings or topping with high water content on pizza as this can make the pizza soggy. Example is mushrooms or bell peppers, always roast simular toppings before so most of the water is removed.
- Topping can with benefit be placed on the pizza after taking it out from the oven.
- When taking the pizza out from the oven, place it on a grid or screen that is elevated at least 50mm/2in as this lets the pizza “ventilate” (pizza is still baking after it is removed from oven and if placing it on a flat surface it will condensate water and this will be sucked up into the crust making it soggy). Let the pizza rest like this for 1-2min.

Maintenance and Preventative Maintenance

Warning!

- DO NOT** use any cleaning agents on the hearthstones
- DO NOT** use pressure washing equipment or a water hose to clean the oven
- DO NOT** use abrasive materials like steel wool or abrasive sponges to clean the oven door glass or the under built cabinets glass doors
- DO NOT** clean the oven door glass until it's cool enough to touch
- DO NOT** use any oven cleaners or detergents to clean the aluminum coated steel interior
- DO NOT** clean the oven when it is hot to avoid burning injuries
- DO NOT** clean ovens in Phantom Black or Royal Gold exterior with any abrasive cleaners inclusive of PizzaMaster cleaning cloth for stainless steel surfaces

Preventive Maintenance

- DO** always install oven with required minimum clearance for easy maintenance
- DO** create a cleaning program and regularly clean the oven
- DO** routinely service the oven and only use original parts
- DO** contact your nearest PizzaMaster representative or PizzaMaster directly if maintenance or repairs are necessary

Important!

It is possible to use conventional non toxic oven cleaners but for the best possible cleaning result we always recommend PizzaMaster cleaning products

Environment friendly cleaning

PizzaMaster has developed a unique range of cleaning and maintenance products especially made for pizza and bakery ovens. Using these products saves the environment at the same time as they are much easier to use than conventional oven cleaning products and helps keep your oven new longer.

Product	Art. No	Suitable for
Oven brush Metal with scraper	50053-01	cleaning the ovens hearth stones from soot and baking deposits
Oven brush Soft	50053-02	cleaning the ovens hearth stones from soot and baking deposits
Cleaning cloth package	50341	removing burned soot from ovens stainless steel exterior no more need for oven cleaners when removing hard burned soot or deposits, this cloth cleans the ovens stainless steel exterior dry without the use of any water or cleaning fluids.
Cleaning sponge package	50716	regular exterior cleaning and cleaning oven door glass sponge with one side that is a regular sponge and the other side is a scratchy but non abrasive side that makes the daily cleaning very easy

To order these products contact your nearest PizzaMaster representative or PizzaMaster HQ directly

Cleaning and Maintenance

Daily

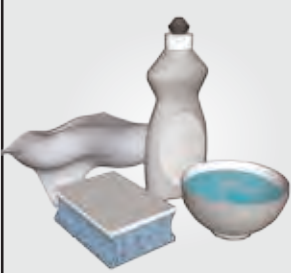

1. Prepare Solution

Damp a nonabrasive sponge in a solution of dish liquid and water. Use a soft cloth to dry!



2. Clean Surfaces

Clean stainless steel front exterior, door handles, display, glass and shelves. Dry with a soft cloth!



3. Clean Stone

Brush and scrape out bake deposit or soot regularly during the day. Use a metal and soft brush!

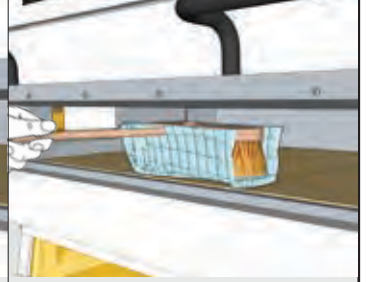

4. Brush Wrapped

It is possible to use a cloth lightly dampened with water and wrapped around the head of the brush.

Weekly

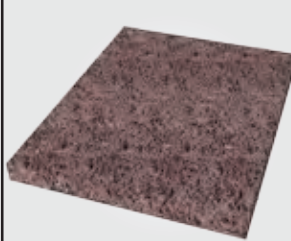

5. Use PizzaMaster Cleaning Cloth

PizzaMaster Cleaning cloth is special for stainless steel material.

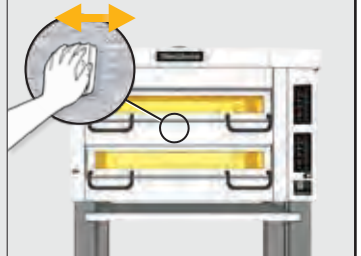

6. Clean Surfaces

Clean all the stainless steel surfaces with the cloth, always with grain direction. Do NOT use over glass, display, handles or labels!

Monthly



7. Lubricate

Lubricate all the door bushings.



8. Use High Temperature Lubricant

Use a non-toxic high temperature lubricant.

Yearly



9. Clean Oven Chamber

Wait until the oven is completely cold and remove the stones; lift up the stones using a flat screwdriver.



10. Vacuum Oven Chamber

Vacuum the chamber and place back the stones exact in the same position and location.



11. Ventilation Outlets

Clean soot and residues from the front and back top ventilation outlets.

Important



Always clean with grain direction!

Steam System Cleaning and Maintenance

Cleaning

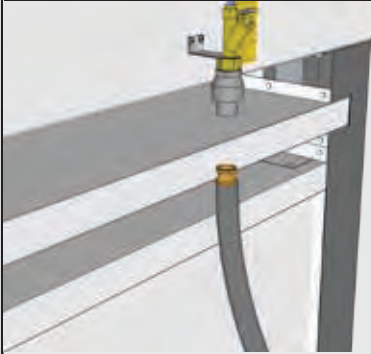

1. Turn off the water supply and disconnect the hose from the oven.



2. Open the filter on the back flow valve

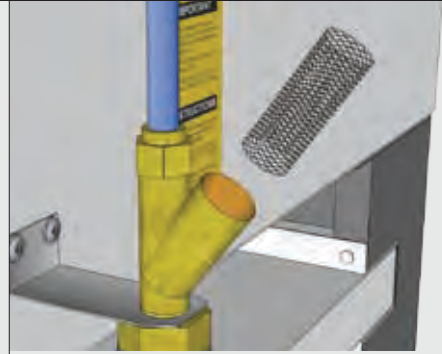

3. Take out the filter and clean it

Maintenance

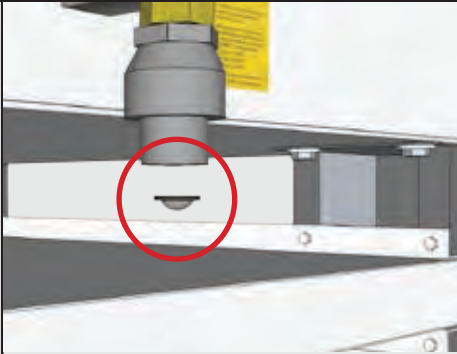

4. From the Water Block, take out the filter and clean it

*Repeat the "Installation steps" before using the Steam System

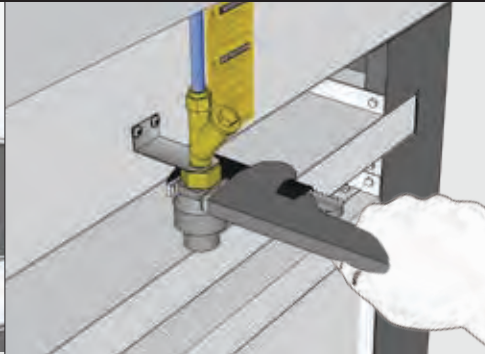

1. **RESET WATER BLOCK:**
If a failure occurs causing a continuous water leak, the Water Block will shut off.
Using a pipe wrench, remove the Water Block Safety valve



2. Press the red plunger to reset the Water Block

*Repeat the "Installation steps" before using the Steam System

UBC Cleaning

Daily



Empty the water container and clean the inside of the container with a sponge lightly dampened with a mix of water and dish fluid. Dry with a clean soft cloth.

Weekly

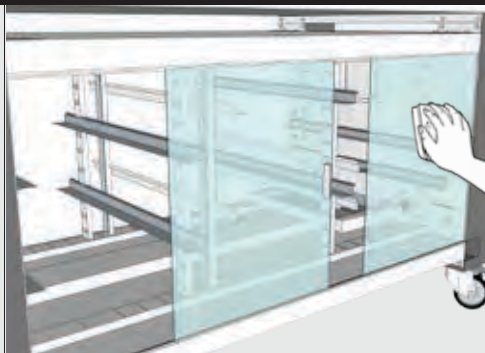

Clean the glass and interior cabinet using a sponge lightly dampened with a mix of water and dish fluid. If necessary use the sponges white non abrasive side. Dry with a clean soft cloth

Monthly

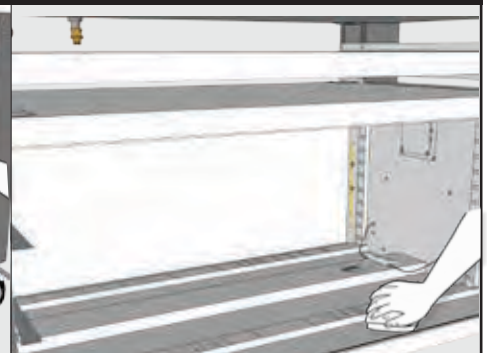

Remove all interior removable parts. Clean all surfaces and corners inside with a sponge lightly dampened with a mix of water and dish fluid. Dry surfaces with a clean soft cloth.

Changing of oven lamp and door gasket

How to replace the oven lamps

Important!

Never touch the oven lamp with your fingers, this will result in severe shortage of the lamps lifetime, use gloves, a piece of paper or a piece of fabric to hold the lamp when replacing it.

Important!

Never use other than original oven lamps supplied from your PizzaMaster representative or directly from PizzaMaster as this can damage the lamp transformer and the lamp socket.

Warning!

Never try to change the oven lamp when the oven is hot, this can lead to severe burn injuries.

<p>Carefully remove the glass, you can use a flat screwdriver.</p> <p>Do not allow the glass to fall on the stone</p>	<p>Take out the defective lamp. Make sure the old lamp has the 2 pin legs like the new lamp. If not part of the old lamp can still be left in the lamp socket, in this case it is necessary to replace also the lamp socket.</p>	<p>Place a small amount of copper paste on the new lamp pins make sure not to place any copper paste on the lamp bulb.</p> <p>Never touch the new lamp directly with your fingers!</p>	<p>Place the new lamp into the lamp socket. Never touch the new lamp directly with your fingers.</p> <p>Fit back the lamp glass.</p>

How to remove door gasket for cleaning or replacement

<p>Wait until the oven is at room temperature.</p> <p>Open the door.</p>	<p>For replacement of door gasket it is necessary to use a screwdriver with Phillips Head.</p> <p>Remove all screws, on both left right hand and lower side of the oven door.</p>	<p>Remove the gasket.</p> <p>Make sure that the old gasket is fully removed.</p>	<p>Place the gasket in the gap between the door frame and the stainless steel parts. Make sure the gasket is left out with 8mm/0.3in.</p> <p>Fasten gasket and stainless steel parts by attaching all screws.</p>

Throubleshooting

Throubleshooting

For reasons of safety and the validity of the warranty, all electrical work must be carried out by a qualified electrician.

SYMPTOM	POSSIBLE CAUSE	PROBABLE SOLUTION
The oven (all decks) does not start, oven deck lights is off and display (ED model) is completely dark	The power to the oven has been disconnected	Control voltage for all phases on terminal X100 on deck 1
	Bottom decks internal circuit breaker F101 has tripped	Reset tripped breaker
	1 or more burned out PCB board. A broken PCB board is mostly recognized by a slightly round top of the PCBs black transformer, when not broken/short circuit it is flat.	Replace the broken PCB boards. Control voltage as the most common cause to a broken PCB board is a faulty electrical/voltage connection.
	If equipped with automatic start/stop timer, settings are incorrect or timer is broken	Set main switch to position 1, restart oven. If oven starts see page 30-33 for correct timer settings, restart with timer again. If timer is broken replace timer.
1 oven deck does not start, OFF is visual in the display	Only for ED model, automatic timer function is activated (Auto LED is lid up green) next to ON/OFF button on the decks display.	Press and hold the displays ON/OFF button until the Auto LED is turned off, then start the deck by pressing the ON/OFF button
1 or 2 (per deck) oven lights does not work but oven deck is heated normal	1 or more oven lamp bulbs is broken	Replace the broken lamp bulbs, see page 21
	PCB board lamp output terminal can be broken.	Control voltage between terminals (for ED models "LA" on green contact to PCB board), should be 200-250V, if not replace PCB board.
	If both lamps are out the lamp transformer can be broken (it is important to use original lamp bulbs)	Control voltage on ceramic terminal prior lampsocket, voltage should be 10-12V. If not replace lamp transformer.
	Lampsocket is broken. (still no lights and lamp -bulbs -PCB board -transformer have been checked OK)	Replace lampsocket.
Oven temperature drop too much or recovery period is too long	Top and/or Top Front heat zones settings are too low	Increase Top and/or Top Front heat zones, see page 26
	The draft connected to the ovens ventillation is too high	Reduce draft, see page 16
	The power to the oven has been partly disconnected	Check external breakers/fuses and check that there is power in all the incoming phases
	The ovens ventillation is closed when oven is fully loaded	Open the ovens ventilation
	A contactor has burned out or a contactor output is broken	Check contactors all in- and outputs (L1-L3 and T1-T3)

If solution is not found please contact your nearest PizzaMaster our service department on: e-mail: service@bakepartner.com or phone: + 4633-230 025

The top of the pizza is too dark	Top and Top Front heat zones are too high	Decrease Top and/or Top Front heat zones, see page 23 and 26
	The temperature is too high	Decrease temperature
	The baking time is too long	Decrease baking time
The bottom of the pizza is too dark	Bottom Heat Zone is set too high	Decrease Bottom heat zone
	Temperature is too high	Decrease temperature
	The oven has been used for a long period	Swipe the stone hearths with a lightly by water damped cloth
	Temperature is too high in relation to pizza dough recipe	See baking guidelines on page 34-35
Both top and bottom of the pizza is too dark	Baking time is too long	Reduce baking time
	Temperature is too high	Reduce temperature
	Pizza recipe needs to be reviewed	See baking guidelines on page 34-35
Baking time is too long before the pizza is ready	Temperature is too low	Increase temperature
	Top and/or Top Front heat zone settings are set too low	Increase Top and/or Top Front heat zones
	Pizza recipe needs to be reviewed	See baking guidelines on page 34-35
The pizza is not baked enough at the front of the oven	Top Front heat zone is too low or Top heat zone too high	Balance Top heat zones. Top Front should be +2 in relation to Top, see page 26
	The door sealing is bad or broken	Replace door sealing
The pizza is baked too much at the front of the oven	Top Front heat zone is too high or Top heat zone too low	Balance Top heat zones. Top Front should be +2 in relation to Top, see page 26
	A contactor has burned out or a contactor output is broken	Check contactors all in- and outputs (L1-L3 and T1-T3)
The oven bakes uneven in certain spots	The entire deck is not used or pizza is placed on a favorite spot in the oven.	Always rotate the placement of the pizzas by working left to right and front to back.
	A contactor has burned out or a contactor output is broken	Check contactors all in- and outputs (L1-L3 and T1-T3)
The pizza crust is too soft	The ovens ventilation is closed	Open the ovens ventilation
	Dough recipe needs to be reviewed	See baking guidelines on page 34-35
The pizza is too wet	Dough recipe needs to be reviewed	See baking guidelines on page 34-35

Capacities and technical data



PizzaMaster® 700 series

Model	Dimensions in millimetres Width x Depth x Height (incl. support, hood)		Dimensions in inches Width x Depth x Height (incl. support, hood)		Decks	Power kW per deck	Capacity - pizzas per deck								
	External	Internal	External	Internal			254 mm 10 in	355 mm 14 in	406 mm 16 in	457 mm 18 in					
	PM 721	1125 x 905	710x710x210 Optional high deck = 245	44.3 x 35.6			28.0x28.0x8.2 Optional high deck = 9.6	1	6.7	6	4	2	1		
PM 722	x 480 (1 655)				x 18.9 (65.2)	2									
PM 723	x 820 (1 825)				x 32.3 (71.9)									3	
PM 724	x 1160 (1 910)				x 45.7 (75.2)										4
PM 725	x 1500 (1 995)				x 59.1 (78.5)										
PM 731	1480 x 905	1065x710x210 Optional high deck = 245	58.3 x 35.6	42.0x28.0x8.2 Optional high deck = 9.6	1	9.5	11	6	3	2					
PM 732											x 480 (1 655)	x 18.9 (65.2)	2		
PM 733											x 820 (1 825)	x 32.3 (71.9)		3	
PM 734											x 1160 (1 910)	x 45.7 (75.2)			4
PM 735											x 1500 (1 995)	x 59.1 (78.5)			
PM 741	1835 x 905	1420x710x210 Optional high deck = 245	72.3 x 35.6	56.0x28.0x8.2 Optional high deck = 9.6	1	12.5	15	8	4	3					
PM 742											x 480 (1 655)	x 18.9 (65.2)	2		
PM 743											x 820 (1 825)	x 32.3 (71.9)		3	
PM 744											x 1160 (1 910)	x 45.7 (75.2)			4
PM 745											x 1500 (1 995)	x 59.1 (78.5)			



PizzaMaster® 800 series

Model	Dimensions in millimetres Width x Depth x Height (incl. support, hood)		Dimensions in inches Width x Depth x Height (incl. support, hood)		Decks	Power kW per deck	Capacity - pizzas per deck								
	External	Internal	External	Internal			254 mm 10 in	355 mm 14 in	406 mm 16 in	457 mm 18 in					
	PM 821	1250 x 1025	820x820x210 Optional high deck = 245	49.2 x 40.4			32.3x32.3x8.2 Optional high deck = 9.6	1	9.0	9	4	4	2		
PM 822	x 480 (1 655)				x 18.9 (65.2)	2									
PM 823	x 820 (1 825)				x 32.3 (71.9)									3	
PM 824	x 1160 (1 910)				x 45.7 (75.2)										4
PM 825	x 1500 (1 995)				x 59.1 (78.5)										
PM 831	1660 x 1025	1230x820x210 Optional high deck = 245	65.4 x 40.4	48.4x32.3x8.2 Optional high deck = 9.6	1	13.5	14	6	6	3					
PM 832											x 480 (1 655)	x 18.9 (65.2)	2		
PM 833											x 820 (1 825)	x 32.3 (71.9)		3	
PM 834											x 1160 (1 910)	x 45.7 (75.2)			4
PM 835											x 1500 (1 995)	x 59.1 (78.5)			
PM 841	2070 x 1025	1640x820x210 Optional high deck = 245	81.5 x 40.4	64.6x32.3x8.2 Optional high deck = 9.6	1	17.0	18	9	8	5					
PM 842											x 480 (1 655)	x 18.9 (65.2)	2		
PM 843											x 820 (1 825)	x 32.3 (71.9)		3	
PM 844											x 1160 (1 910)	x 45.7 (75.2)			4
PM 845											x 1500 (1 995)	x 59.1 (78.5)			



PizzaMaster® 900 series

Model	Dimensions in millimetres Width x Depth x Height (incl. support, hood)		Dimensions in inches Width x Depth x Height (incl. support, hood)		Decks	Power kW per deck	Capacity - pizzas per deck								
	External	Internal	External	Internal			254 mm 10 in	355 mm 14 in	406 mm 16 in	457 mm 18 in					
	PM 921	1350 x 1125	920x920x210 Optional high deck = 245	53.2 x 44.3			36.2x36.2x8.2 Optional high deck = 9.6	1	11.0	12	5	4	4		
PM 922	x 480 (1 655)				x 18.9 (65.2)	2									
PM 923	x 820 (1 825)				x 32.3 (71.9)									3	
PM 924	x 1160 (1 910)				x 45.7 (75.2)										4
PM 925	x 1500 (1 995)				x 59.1 (78.5)										
PM 931	1810 x 1125	1380x920x210 Optional high deck = 245	71.3 x 44.3	54.3x36.2x8.2 Optional high deck = 9.6	1	16.9	18	8	6	6					
PM 932											x 480 (1 655)	x 18.9 (65.2)	2		
PM 933											x 820 (1 825)	x 32.3 (71.9)		3	
PM 934											x 1160 (1 910)	x 45.7 (75.2)			4
PM 935											x 1500 (1 995)	x 59.1 (78.5)			
PM 941	2270 x 1125	1840x920x210 Optional high deck = 245	89.4 x 44.3	72.4x36.2x8.2 Optional high deck = 9.6	1	21.4	24	11	8	8					
PM 942											x 480 (1 655)	x 18.9 (65.2)	2		
PM 943											x 820 (1 825)	x 32.3 (71.9)		3	
PM 944											x 1160 (1 910)	x 45.7 (75.2)			4
PM 945											x 1500 (1 995)	x 59.1 (78.5)			

For complete technical information refer to technical specification sheets for each individual oven series



EU-Declaration of conformity

Svenska BakePartner AB
declare under sole responsibility that the PizzaMaster oven
is approved and in conformity with,

Electromagnetic compatibility Directive **2004/108/EC**,
and applicable supplements

Low voltage Directive **2006/95/EC**, and applicable supplements

PizzaMaster®

Modular ovens

PM 721 - PM 722 - PM 723 - PM 724 - PM 725
PM 731 - PM 732 - PM 733 - PM 734 - PM 735
PM 741 - PM 742 - PM 743 - PM 744 - PM 745

PM 821 - PM 822 - PM 823 - PM 824 - PM 825
PM 831 - PM 832 - PM 833 - PM 834 - PM 835
PM 841 - PM 842 - PM 843 - PM 844 - PM 845

PM 911 - PM 912 - PM 913 - PM 914 - PM 915
PM 921 - PM 922 - PM 923 - PM 924 - PM 925
PM 931 - PM 932 - PM 933 - PM 934 - PM 935
PM 941 - PM 942 - PM 943 - PM 944 - PM 945

.....
Christer Andersson
Managing Director
Svenska BakePartner AB
Date
2014-04-01

NEW SOLUTIONS

*We are always ready
to assist you!*

OLD TRADITIONS



PizzaMaster®

PizzaMaster® Stone Hearth Deck Ovens are manufactured by Svenska BakePartner AB

Customer Support: Tel: +46 33 230-025 | Fax: +46 33 248-140 | E-mail: info@bakepartner.com

Website: www.pizzamaster.com or www.bakepartner.com | HQ: Svenska BakePartner AB, Odegardsgatan 5, SE 504 64 Boras Sweden