

Service Manual

Horizontal Infrared Toaster IRT-SB-NA-1PS IRT-SB-NA-3PS

Product Identification

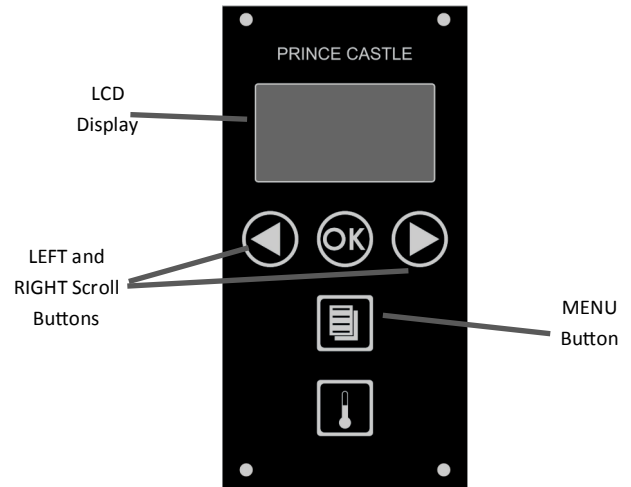
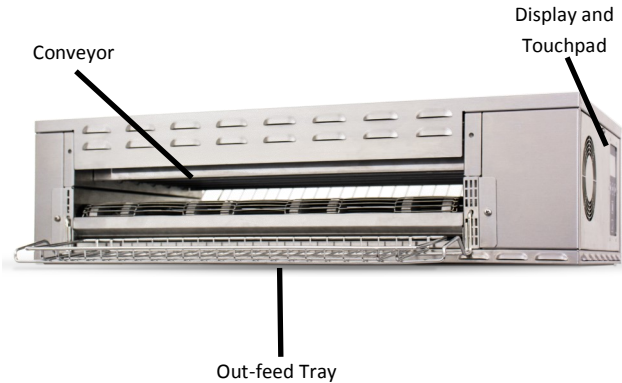

LIMITED WARRANTY

This product is warranted to be free from defects in material and/or workmanship for a period of two (2) years from date of original installation, not to exceed 30 months from date of shipment from our factory. Any part or component which proves to be faulty in material and/or workmanship within the warranty period will be replaced or repaired (at the option of Prince Castle, Inc.) without cost to the customer for parts or labor.

This warranty is subject to the following exceptions/conditions:

- Use of any non-genuine Prince Castle parts voids this warranty and all work must be performed by an authorized Prince Castle Service Agent.

- All labor shall be performed during regular work hours. Overtime premium will not be covered.

- Travel charges are limited to 200 kilometers (100 miles) round trip, 2 hours travel time, one trip per repair.

- Damage caused by carelessness, neglect, and/or abuse (e.g., using wrong current, dropping, tampering with or altering electrical components, or improper cleaning) is not covered.

- Equipment damaged in shipment, by fire, flood or an act of God is not covered.

- Damage to non-stick coated surfaces is not covered by this warranty.

Product Identification.....Pg 1	Remove Control Side Bread Selection Board.....Pg 22
Warranty Statement.....Pg 1	Replace Control Side Bread Selection Board.....Pg 22
Table of Contents.....Pg 1	Remove Right Side Bread Selection Board.....Pg 23
Electrical Specifications.....Pg 2	Replace Right Side Bread Selection Board.....Pg 23
Safe Service Practices.....Pg 2	Remove Wire Belt.....Pg 24
Serial Number Matrix.....Pg 2	Replace Wire Belt.....Pg 25
Tools Required.....Pg 3	Remove Power Cord.....Pg 26
Fault Identification.....Pg 4	Replace Power Cord.....Pg 26
Troubleshooting Steps.....Pg 5	Remove Power Supply.....Pg 27
Wiring Diagram.....Pg 6	Replace Power Supply.....Pg 27
Exploded View/Parts List.....Pg 7	Remove Power Supply.....Pg 28
Display Menu Options.....Pg 11	Replace Power Switch.....Pg 28
Management Programming..Pg 13	Remove Control Side Fan....Pg 29
Remove Main Board.....Pg 16	Replace Control Side Fan....Pg 29
Replace Main Board.....Pg 16	Remove Right Side Fan.....Pg 30
Remove Relay.....Pg 17	Replace Right Side Fan.....Pg 30
Replace Relay.....Pg 17	
Remove Motor.....Pg 18	
Replace Motor.....Pg 18	
Remove Display Assy.....Pg 19	
Replace Display Assy.....Pg 19	
Remove Calrod(s).....Pg 20	
Replace Calrod(s).....Pg 21	



355 East Kehoe Blvd. • Carol Stream, IL 60188 USA
Telephone: 630-462-8800 • Toll Free: 1-800-PCASTLE
Fax: 630-462-1460 • www.princecastle.com

Horizontal Infrared Toaster

IRT-SB-NA-1PS

IRT-SB-NA-3PS



Electrical Specifications

IRT-SB-NA-1PS 208 V, 60 Hz, 4500 W, 1 Ph.

Disconnect Power

 **WARNING**

Failure to turn off the unit before servicing could result in severe bodily injury or death. Switch the On/Off switch to the Off position before servicing.

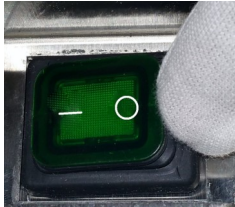

Important

Prince Castle reserves the right to change specifications and product design without notice. Such revisions do not entitle the buyer to corresponding changes, improvements, additions, or replacements for previously purchased equipment.

Safe Service Practices

 **WARNING**

Indicates information important to the proper operation of the unit. Failure to observe may result in damage to the equipment and/or severe bodily injury or death.

 **CAUTION**

Indicates information important to the operation of the unit. Failure to observe may result in damage to the equipment.

GENERAL

This appliance is designed for toasting bread products in a commercial McDonalds kitchen. The dimensions of the bread products as defined by McDonalds.

 **CAUTION**

Do not hose down or use a water jet on the unit. Keep the unit away from running water. Disconnect power cord before performing any cleaning or maintenance.

 **CAUTION**

Equipment must be elevated from the floor at all times during cleaning and operation.

Serial Number Matrix

The manufacture date is encoded in the unit's serial number. The service bench installation date (used to determine warranty coverage) is considered to be the end of the following month. For example:

Serial Number: LK0000458

Manufacture Date: November 2015

Service Bench Installation Date: December 15, 2015

		SERIAL NUMBER MATRIX									
		2014	2015	2016	2017	2018	2019	2020	2021	2022	
		J	K	L	M	N	O	P	Q	R	
January	A	AJ	AK	AL	AM	AN	AO	AP	AQ	AR	
February	B	BJ	BK	BL	BM	BN	BO	BP	BQ	BR	
March	C	CJ	CK	CL	CM	CN	CO	CP	CQ	CR	
April	D	DJ	DK	DL	DM	DN	DO	DP	DQ	DR	
May	E	EJ	EK	EL	EM	EN	EO	EP	EQ	ER	
June	F	FJ	FK	FL	FM	FN	FO	FP	FQ	FR	
July	G	GJ	GK	GL	GM	GN	GO	GP	GQ	GR	
August	H	HJ	HK	HL	HM	HN	HO	HP	HQ	HR	
September	J	JJ	JK	JL	JM	JN	JO	JP	JQ	JR	
October	K	KJ	KK	KL	KM	KN	KO	KP	KQ	KR	
November	L	LJ	LK	LL	LM	LN	LO	LP	LQ	LR	
December	M	MJ	MK	ML	MM	MN	MO	MP	MQ	MR	

Horizontal Infrared Toaster

IRT-SB-NA-1PS

IRT-SB-NA-3PS



Tools Required

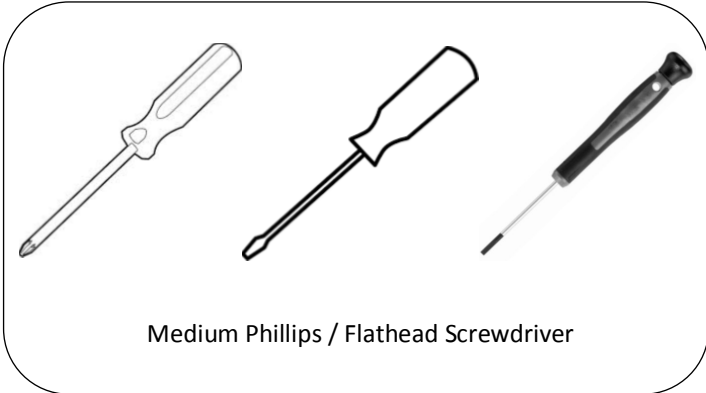

Medium Phillips / Flathead Screwdriver



Stubby Phillips Screw Driver



Selection of Nut Spinners or an Appropriate Small Socket Set

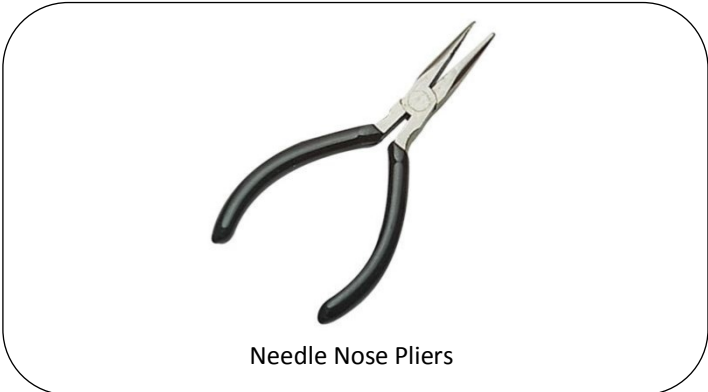

Needle Nose Pliers



C-Clip Pliers

Fault Identification

*THIS PAGE WAS LEFT INTENTIONALLY BLANK. WILL BE
UPDATED AT A LATER TIME*

Horizontal Infrared Toaster

IRT-SB-NA-1PS

IRT-SB-NA-3PS



Troubleshooting Steps

BURN/ELECTRICAL SHOCK HAZARD! Platen is HOT and can cause severe burns or severe shock.
Keep hands and objects out of the toaster unit! Failure to exercise caution may result in serious injury!
Turn the unit off, unplug it and let it cool down completely before touching or working on internal apparatus.

PROBLEM	PROBABLE CAUSE	SOLUTION
Unit will not heat up	No power to unit.	Ensure power cord is connected to proper receptacle.
	Inoperable power cord	Call for Service (800) 722-7853
	Loose connection on power switch	Call for Service (800) 722-7853
	Inoperable power switch	Call for Service (800) 722-7853
	High limit switch tripped	Turn off unit for 20 minutes, and re-start. If high limit switch continues to trip, Call for service (800)722-7853
	Inoperable Heating Element	Call for Service (800) 722-7853
Unit heats up, but the conveyor does not run	Loose motor switch connection.	Call for Service (800) 722-7853
	Loose Conveyor Shaft Drive Collar	Call for Service (800) 722-7853
	Inoperable motor.	Call for Service (800) 722-7853
Unit does not respond to programming.	User interface Malfunction	Call for Service (800) 722-7853
Product under-or over-done.	Check recommended toast time. See operations manual.	See Programming Guide
	Check Power Settings	See Programming Guide

Horizontal Infrared Toaster

IRT-SB-NA-1PS

IRT-SB-NA-3PS



Wiring Diagram

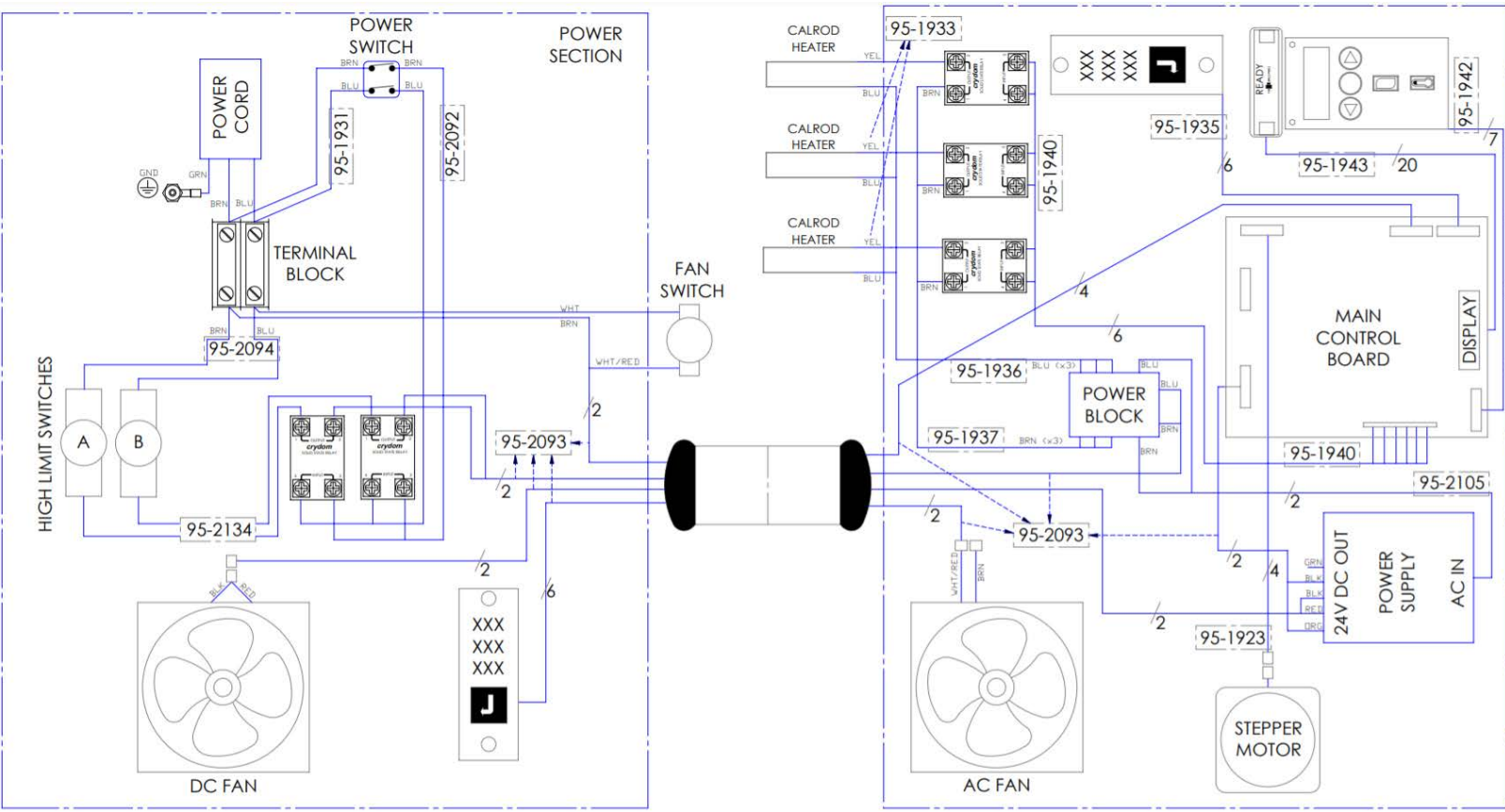

Horizontal Infrared Toaster

IRT-SB-NA-1PS

IRT-SB-NA-3PS



Exploded View and Parts List

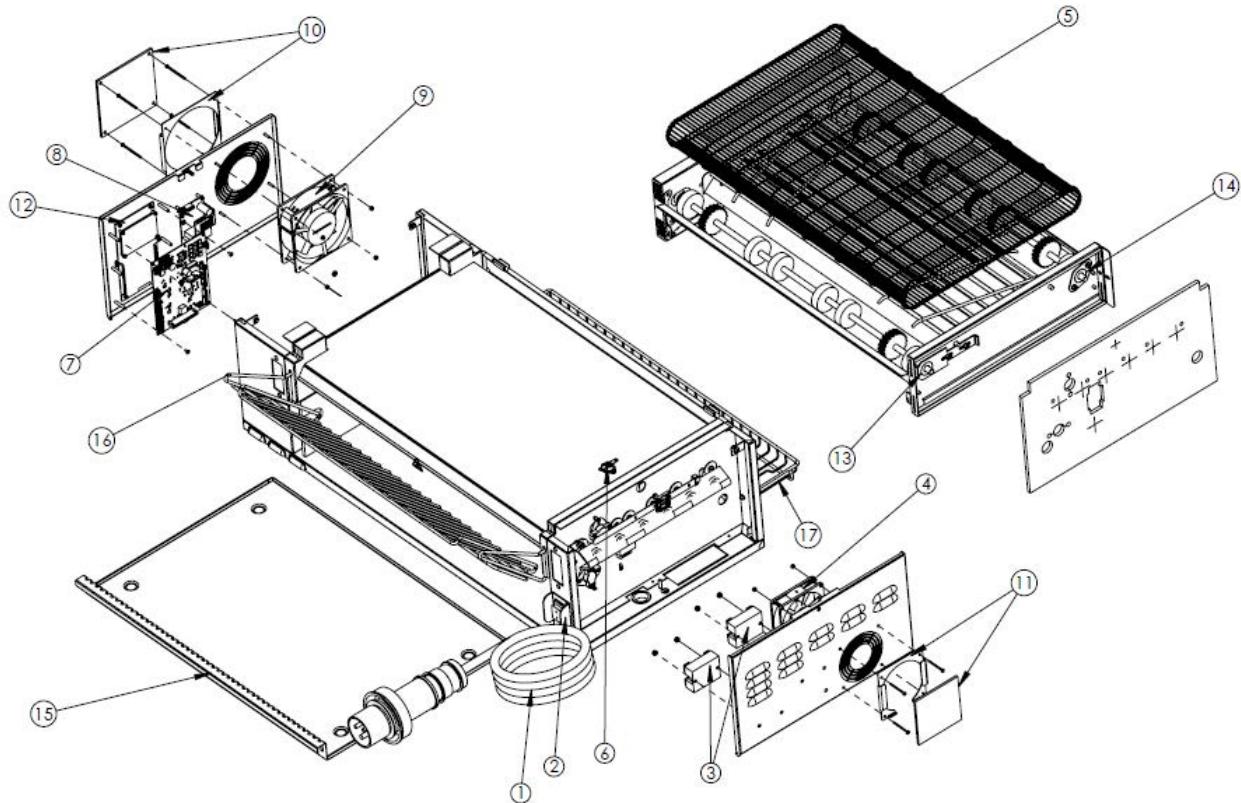

Item #	Part #	Description	Qty
1	72-696S	POWERCORD (FOR IRT-SB-NA-1PS)	1
1	72-697S	POWERCORD (FOR IRT-SB-NA-3PS) NOT SHOWN	1
2	78-233S	SWITCH, ROCKER, DPST, IP65, 16A	1
3	65-064S	MCD KIT, POWER RELAY, Solid State, AC	2
4	86-582S	FAN. 11 A DC 92MM	1
5	353-164S	WIRE BELT	1
6	353-1314S	MCD KIT, 1/2" DISC THERMOSTAT CRA-120-QC	1
7	353-1227S	PCB, MAIN CONTROLLER	1
8	85-147S	POWER SUPPLY, 24VDC 100W	1
9	37814S	MOTOR FAN, 230V	1

Horizontal Infrared Toaster

IRT-SB-NA-1PS

IRT-SB-NA-3PS



Exploded View and Parts List (Continued)

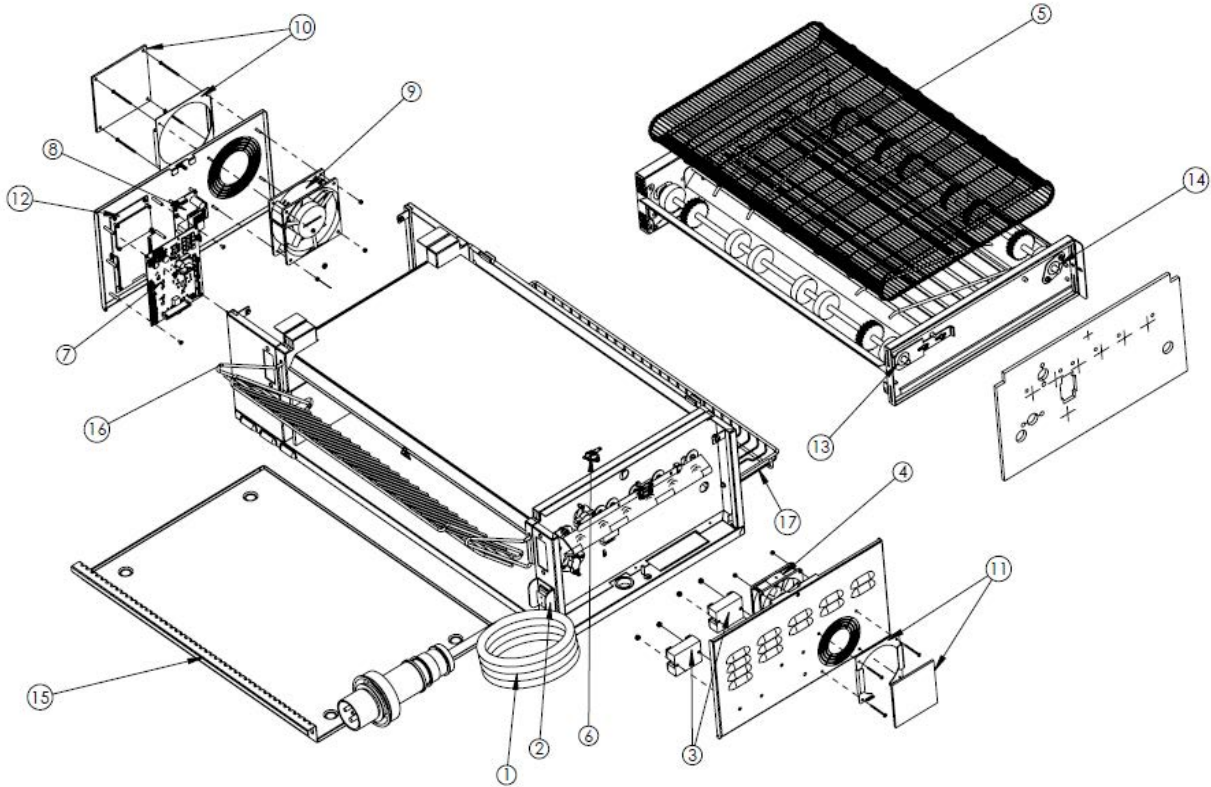

Item #	Part #	Description	Qty
10	353-1306S	IRT/CBT FAN FILTER KIT	1
11	353-1308S	IRT DC FAN FILTER KIT	1
12	353-1315S	MCD KIT, *Shared* LCD GRAPHIC DISPLAY W/ NYLON NUTS, CBT/IRT	1
13	353-1233S	MCD KIT, BRACKET, CONV TENSIONER, IRT	1
14	353-1180S	MCD KIT, BEARING ATTACHMENT PLATE	1
15	353-560S	MCD KIT, IRT CRUMB TRAY	1
16	353-161S	MCD KIT, IRT WIRE IN-FEED RACK	1
17	353-786S	MCD KIT, IRT OUTFEED RACK	1

Horizontal Infrared Toaster

IRT-SB-NA-1PS

IRT-SB-NA-3PS



Exploded View and Parts List (Continued)

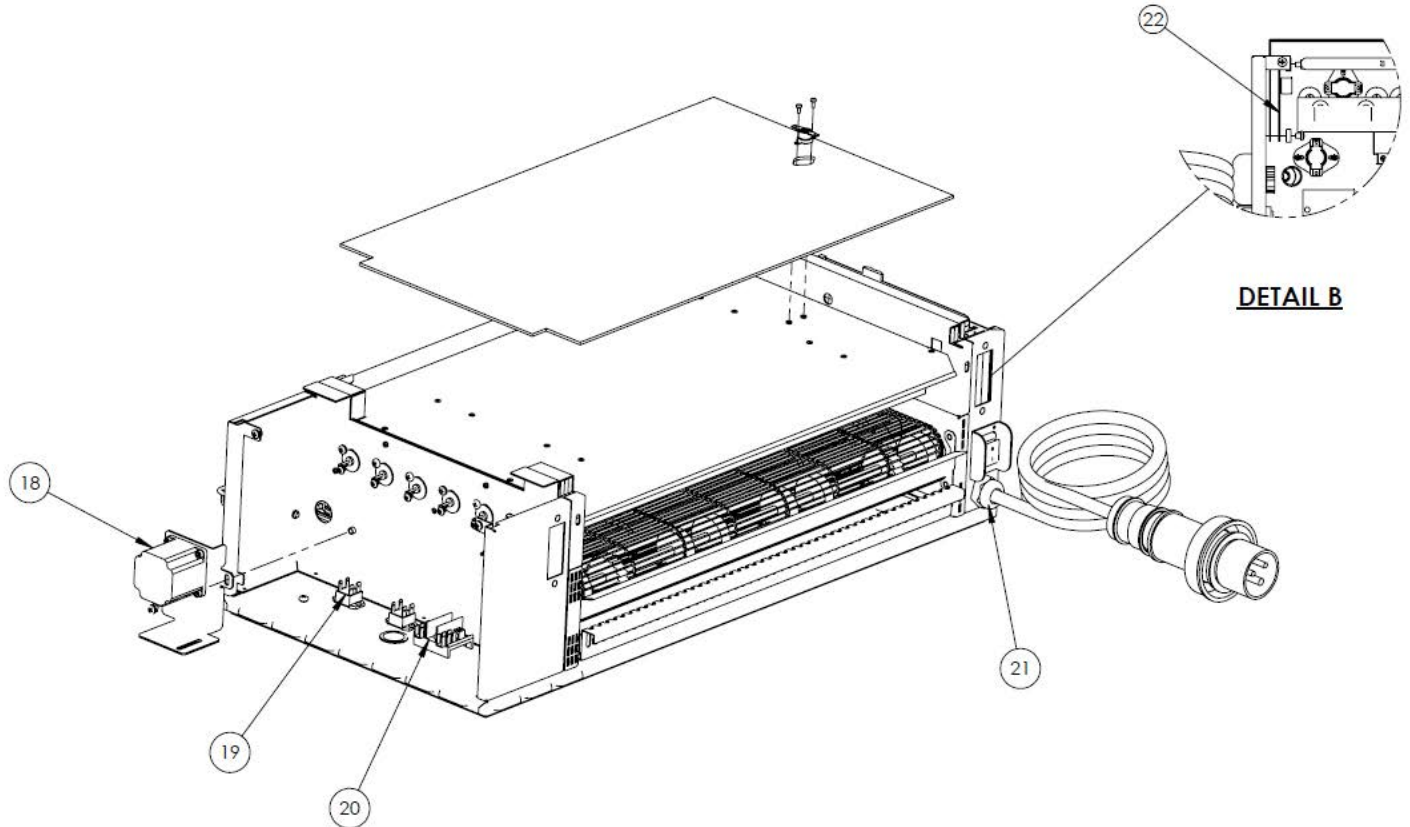

Item #	Part #	Description	Qty
18	353-134S	MCD KIT, MOTOR ASSEMBLY, IRT	1
19	353-313S	MCD KIT IRT RELAY, 4-8VDC, 20A	2
20	77-093S	MCD KIT, IRT/CBT TERMINAL BLOCK SERVICE	1
21	66-045S	MCD KIT, URT STRAIN RELIEF DHB/STEAMER	1
22	353-426S	MCD IRT PCB ASSEMBLY, BREAD SELECT BOARD	1

Horizontal Infrared Toaster

IRT-SB-NA-1PS

IRT-SB-NA-3PS



Exploded View and Parts List (Continued)

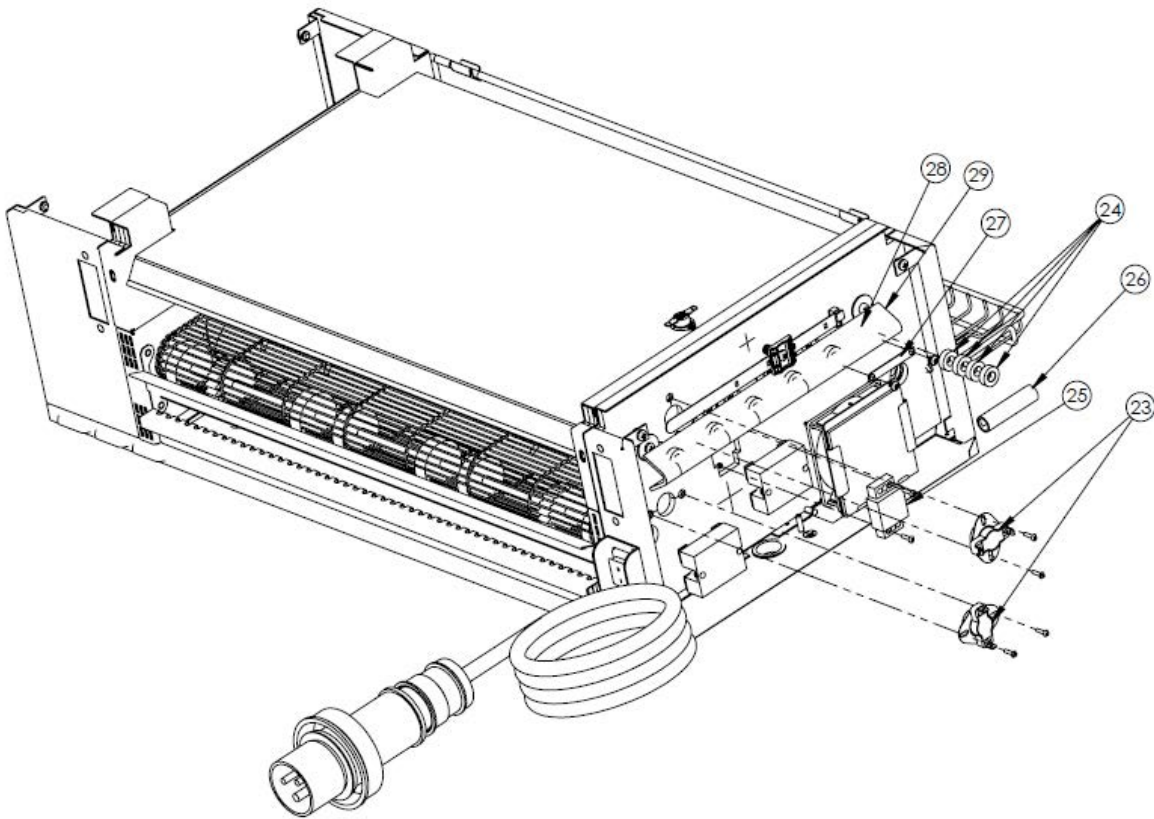

Item #	Part #	Description	Qty
23	353-1298S	THERMOSTAT, NC 300F, LIMIT CONTROL, IRT	2
24	353-525S	MCD KIT, IRT CALROD WASHER	4
25	77-092-02S	MCD KIT, BARRIER STRIP DCFT/IRT/CBT	1
26	353-570S	MCD KIT, IRT CALROD INSULATION	1
27	353-367S	MCD KIT PLATE CONNECTING CALROD, IRT	1
28	353-158S	MCD KIT CALROD, IRT	1
29	353-526S	MCD KIT, IRT CALROD COVER	1

Horizontal Infrared Toaster

IRT-SB-NA-1PS

IRT-SB-NA-3PS



Display Menu Options

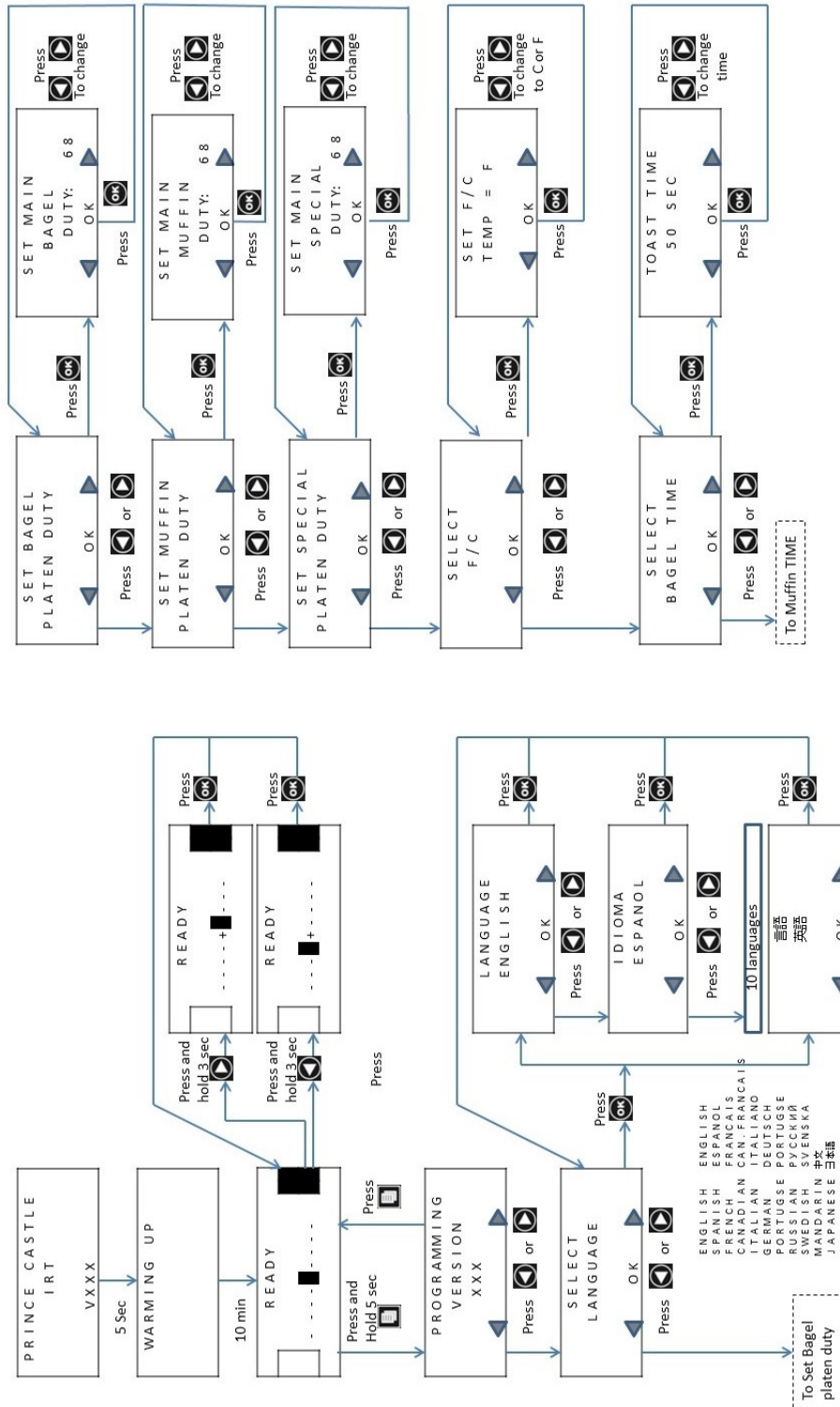

Horizontal Infrared Toaster

IRT-SB-NA-1PS

IRT-SB-NA-3PS



Display Menu Options (Continued...)

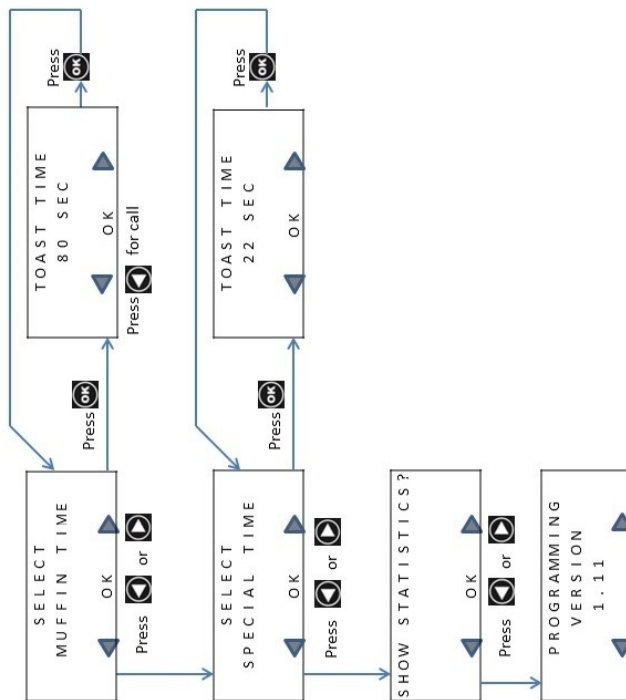

Horizontal Infrared Toaster

IRT-SB-NA-1PS

IRT-SB-NA-3PS



Management Programming

1

To Enter Programming screens
Press and hold the MENU
button for 6 seconds. The
PROGRAMMING VERSION
screen will appear in the LCD
display.

From the PROGRAMMING
VERSION screen, you may:

Press RIGHT scroll
button to advance to the
next menu item



3

To Adjust SET BAGEL
PLATEN DUTY from the
SELECT LANGUAGE
Screen, press the RIGHT
scroll button. Press the OK
button to enter the program-
ming screen.

A. From the SET BAGEL
DUTY screen that
that appears adjust
the set point duty
Using the RIGHT and
LEFT scroll buttons.

NOTE : To cancel without
accepting the new setting,
press the MENU logo button to
return to the previous screen



2

To Change the LANGUAGE
from the PROGRAMMING
VERSION

Screen, PRESS the left scroll
button.

From the SELECT
LANGUAGE Screen,
Press OK button

- A. From the
LANGUAGE screen
that appears, use
the RIGHT and
LEFT scroll buttons.
TO select different
Language
- B. Accept the new
language by pressing
OK button to return to
the SELECT
LANGUAGE screen



4

To Adjust SET MUFFIN
PLATEN DUTY from the
SET BAGEL PLATEN DUTY
Screen, press the RIGHT
scroll button. Press the OK
button to enter the program-
ming screen.

A. From the SET MUFFIN
DUTY screen that
that appears adjust
the set point duty
Using the RIGHT and
LEFT scroll buttons.

NOTE : To cancel without
accepting the new setting,
press the MENU logo button to
return to the previous screen



Horizontal Infrared Toaster

IRT-SB-NA-1PS

IRT-SB-NA-3PS



Management Programming (Continued)

5

To Adjust SET SPECIAL

PLATEN DUTY from the SELECT MUFFIN PLATEN DUTY screen, press the RIGHT scroll button. Press the OK button to enter the programming screen.

- A. From the SET SPECIAL DUTY screen that appears adjust the set point duty Using the RIGHT and

NOTE : To cancel without accepting the new setting, press the MENU logo button to return to the previous screen



7

To adjust set point BAGEL

TOAST TIME from the SELECT F/C screen, press the RIGHT scroll button

From the SELECT BAGEL TOAST TIME Screen, Press OK button

- A. From the SELECT BAGEL TIME that appears, Adjust the set point Time Using the RIGHT and LEFT

Scroll buttons. Accept NOTE : To cancel without accepting the new setting, press the MENU logo button to return to the previous screen



6

To adjust the SELECT F/C From The SELECT SPECIAL PLATEN DUJTY screen, press the RIGHT scroll button.

From the SELECT F/C screen that appears, press the OK button.

- A. From the SET F/C Screen that appears, Use the LEFT and RIGHT scroll buttons to Select TEMP = F (Fahrenheit) or C (Celsius)
- B. Accept the new scale By pressing the OK Button to return to The SELECT F/C screen



8

To adjust set point MUFFIN TOAST TIME from the BAGEL TOAST TIME screen, press the RIGHT scroll button

From the SELECT MUFFIN TOAST TIME Screen, Press OK button

- A. From the SELECT MUFFIN TIME that appears, Adjust the set point Time Using the RIGHT and LEFT

Scroll buttons. Accept NOTE : To cancel without accepting the new setting, press the MENU logo button to return to the previous screen



Horizontal Infrared Toaster

IRT-SB-NA-1PS

IRT-SB-NA-3PS



Management Programming (Continued)

9

To adjust set point SPECIAL TOAST TIME from the MUFFIN TOAST TIME screen, press the RIGHT scroll button



From the SELECT SPECIAL TOAST TIME Screen,
Press OK button

- A. From the SELECT SPECIAL TIME that appears, Adjust the set point Time Using the RIGHT and LEFT



Scroll buttons. Accept
NOTE : To cancel without accepting the new setting, press the MENU logo button to return to the previous screen

11

To view Service Codes, From the SPECIAL MODE ENABLE / DISABLE screen, press the RIGHT scroll button once.



From the Service Codes screen,

- A. Select OK to check the service codes
- B. Refer to Service codes page to understand the



10

To Enable or Disable Special Mode, from the SPECIAL TOAST TIME screen, press the RIGHT scroll button once.

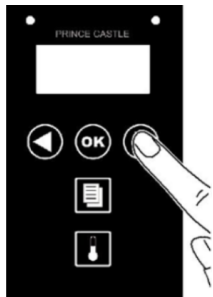

From the SPECIAL MODE ENABLE/DISABLE Screen,
Press OK button

- A. From the SPECIAL MODE ENABLE/DISABLE screen that appears, Adjust the toggle Using the RIGHT and LEFT



Scroll buttons. Accept
NOTE : To cancel without accepting the new setting, press the MENU logo button to return to the previous screen

12

Exit Programming

Press the MENU button from any screen to exit programming mode.



Horizontal Infrared Toaster

IRT-SB-NA-1PS

IRT-SB-NA-3PS



Remove Main Control Board

- 1 Power off and Unplug the unit



WARNING

Failure to disconnect power from the unit before servicing could result in severe bodily injury or death. The ON/OFF Switch does not disconnect incoming power to the unit.

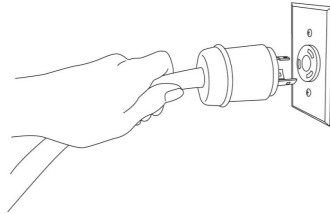

- 2 Using a Phillips head screwdriver, open the control side panel. Reference the **Red Arrow**.

- 3 Remove the (6) connectors from the control board. Reference the **Black Arrows**.

- 4 Remove (4) screws to remove the master control board. Reference the **Blue Arrows**.

- 5 Remove the Board

Replace Main Control Board

- 6 Install the new board

- 7 Using the (4) screws removed in step 4, secure the board onto the electronics tray.

- 8 Reconnect (6) connections onto board that were removed in step 4.

- 9 Using a Phillips screwdriver, secure the control side panel to the unit. Previously opened in step 2.

- 10 Plug in unit. Power on and ensure the unit is fully functional.

References

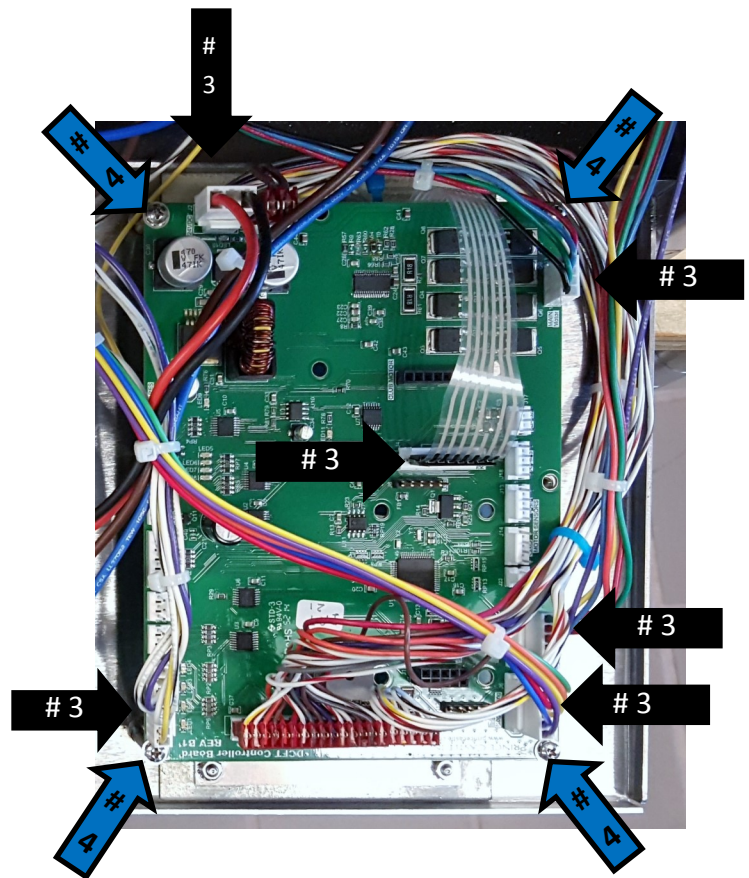
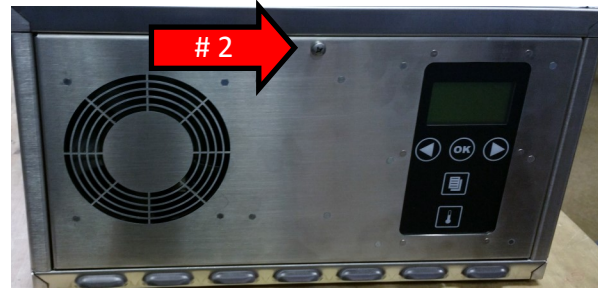

Horizontal Infrared Toaster

IRT-SB-NA-1PS

IRT-SB-NA-3PS



Remove Relay

1 Power off and Unplug the unit

WARNING

Failure to disconnect power from the unit before servicing could result in severe bodily injury or death. The ON/OFF Switch does not disconnect incoming power to the unit.

2 Using a Phillips head screwdriver, open the control side panel. Reference the **Red Arrow**.

3 Remove 4 Wires from relay. Note the position of each wire.

4 Using a Phillips head screwdriver, Remove (2) screws to remove the relay. Refer to **Blue Arrows**.

Replace Relay

5 Install the new board

6 Using the (4) screws removed in step 4, secure the board onto the electronics tray

7 Reconnect (6) connections onto board that were removed in step 4.

8 Using a Phillips screwdriver, secure the control side panel to the unit. Previously opened in step 2.

9 Plug in unit. Power on and ensure the unit is fully functional.

References

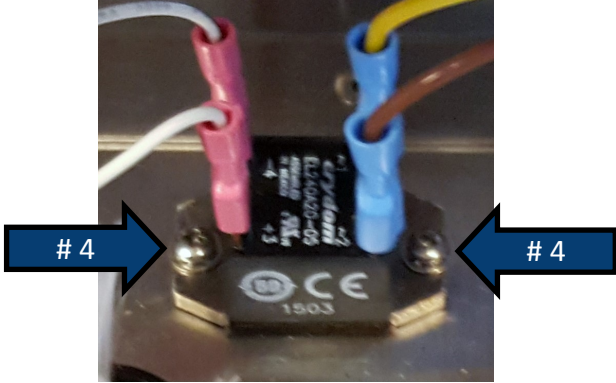
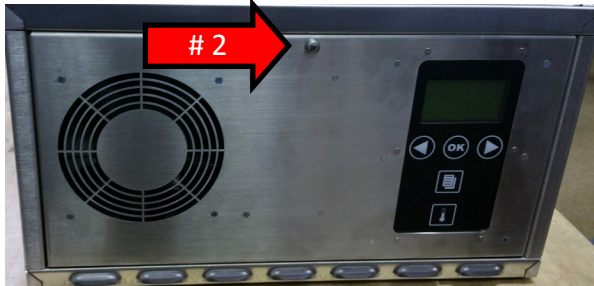

**Close up shown for illustration purposes

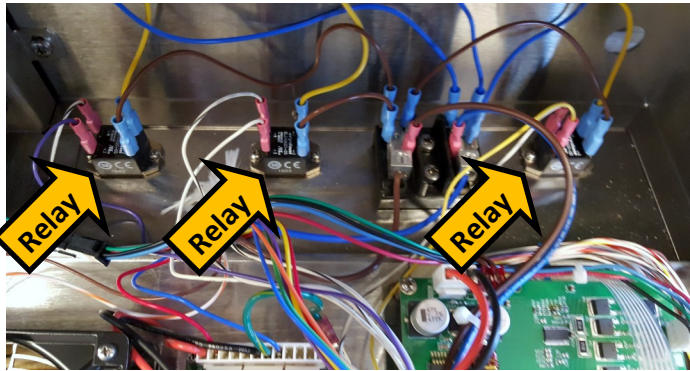

Figure 1

Horizontal Infrared Toaster

IRT-SB-NA-1PS

IRT-SB-NA-3PS

Remove Motor

- 1 Power off and Unplug the unit



WARNING

Failure to disconnect power from the unit before servicing could result in severe bodily injury or death. The ON/OFF Switch does not disconnect incoming power to the unit.

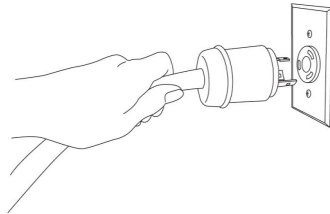

- 2 Using a Phillips head screwdriver, open the control side panel. Reference the **Red Arrow**.

- 3 Unplug motor from the wiring harness. Refer to the **Blue Arrow**.

- 4 Remove the (2) screws using a Phillips screwdriver to release the motor assembly. Refer to the **Green Ar-**

Replace Motor

- 5 Install the new motor assembly. Ensure the motor shaft is aligned with the conveyor. Secure using (2) Phillips Screws.

- 6 Connect the motor wiring harness. Previously removed in step 3.

- 7 Using a Phillips head screwdriver, secure the control side panel. Previously removed in step 2.

- 8 Plug in unit. Power on and ensure the unit is fully functional.

References

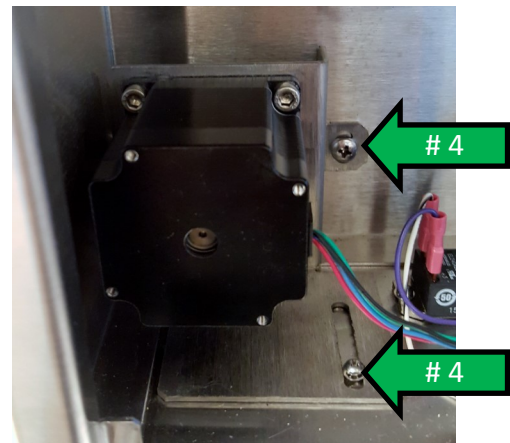
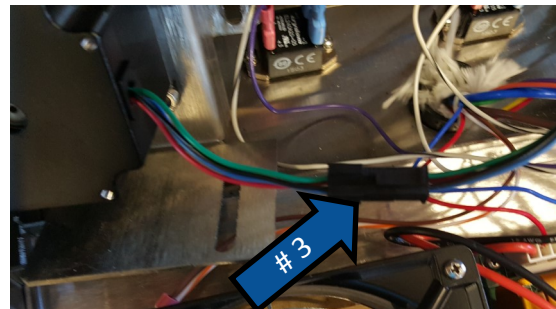
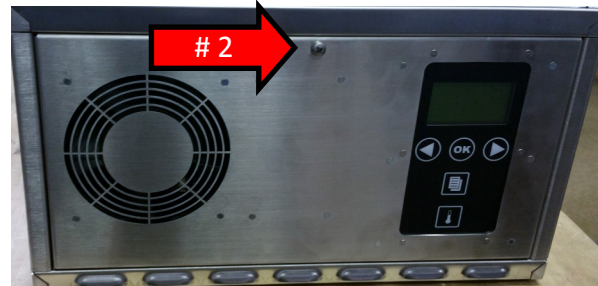

Horizontal Infrared Toaster

IRT-SB-NA-1PS

IRT-SB-NA-3PS



Remove Display Assembly

1 Power off and Unplug the unit

WARNING

Failure to disconnect power from the unit before servicing could result in severe bodily injury or death. The ON/OFF Switch does not disconnect incoming power to the unit.

2 Remove the Main Control Board. Reference the Main Control Board Removal on Page 15.

3 Unplug the Display Harness. Refer to the **Red Arrow**.

4 Remove the (4) M3 nuts. Lift the display assembly off the control side panel. Refer to the **Blue Arrows**.

Replace Display Assembly

5 Reinstall the display assembly by installing the (4) M3 nuts. Previously removed in step 4.

6 Plug in the display harness. Previously removed in step 3.

7 Replace the Main Control Board. Reference the Main Control Board Replacement on Page 14.

8 Plug in unit. Power on and ensure the unit is fully functional.

References

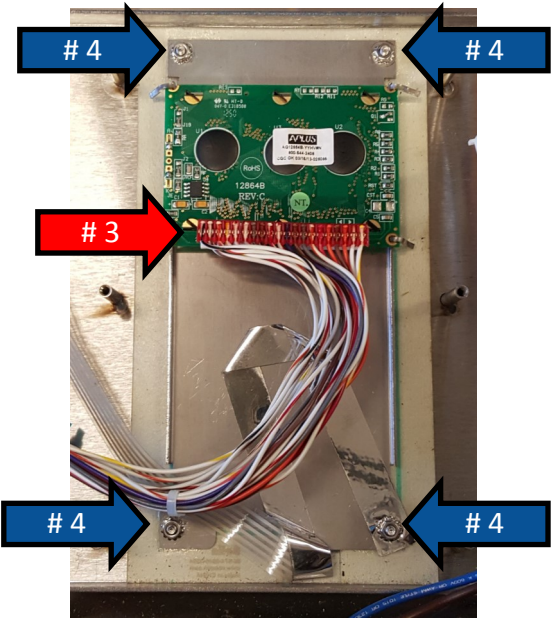

Horizontal Infrared Toaster

IRT-SB-NA-1PS

IRT-SB-NA-3PS



Remove Calrod(s)

1 Unplug the unit



WARNING

Failure to disconnect power from the unit before servicing could result in severe bodily injury or death. The ON/OFF Switch does not disconnect incoming power to the unit.

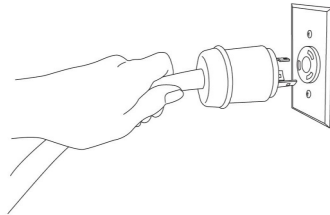

2 Using a Phillips head screwdriver, open the control side panel. Reference the **Red Arrow**.

3 Using a Phillips head screwdriver, open the right side panel. Reference the **Green Arrow**.

4 On the unit's control side, remove the screw that secures the Calrod which needs to be replaced. Reference the **Blue Arrow**.

5 On the right side of the unit, remove all insulation that is covering the Calrod connections.

6 On the right side of the unit, remove the screw that secures the calrod which needs to be replaced. Reference the **Orange Arrow**.

7 On the right side of the unit, remove the screw that secures the calrod to the calrod connecting bracket. Reference the **Black Arrow**.

8 On the control side of the unit, remove the calrod by pulling out. The calrod may need to be rotated while removing. Refer to the **Yellow Arrow**.

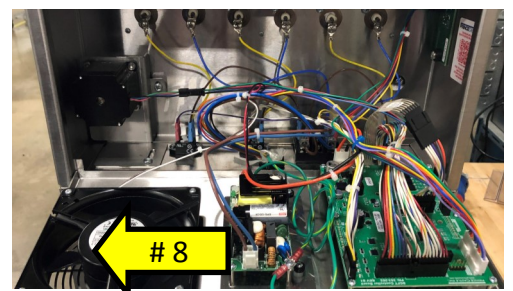
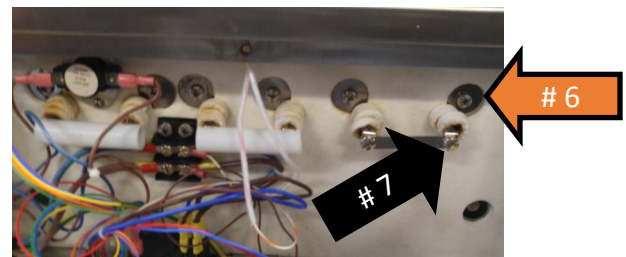
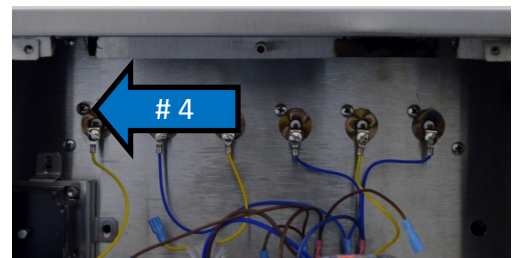

Horizontal Infrared Toaster

IRT-SB-NA-1PS

IRT-SB-NA-3PS



Replace Calrod(s)

- 9** Reinstall the calrod by inserting into the unit from the Control Side. Previously removed in step 8.
- 10** On the right side, secure the calrod to the calrod connecting bracket using a Phillips screw. Previously removed in step 7
- 11** On the right side, secure the calrod to the unit using a Phillips screw. Previously removed in step 6.
- 12** On the right side, reinstall all insulation that covers the calrod connections. Previously removed in step 5.
- 13** On the control side, secure the calrod to the unit using a Philips screw. Previously removed in step 4.
- 14** Using a Phillips head screwdriver, secure the right side panel. Previously removed in step 3.
- 15** Using a Phillips head screwdriver, secure the control side panel. Previously removed in step 2.
- 16** Plug in unit. Power on and ensure the unit is fully functional.

Horizontal Infrared Toaster

IRT-SB-NA-1PS

IRT-SB-NA-3PS

Remove Control Side Bread Selection Board

1 Power off and Unplug the unit



WARNING

Failure to disconnect power from the unit before servicing could result in severe bodily injury or death. The ON/OFF Switch does not disconnect incoming power to the unit.

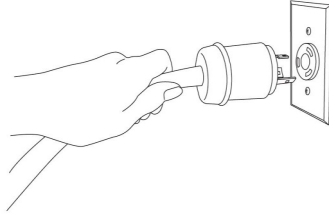

2 Using a Phillips head screwdriver, open the control side panel. Reference the **Red Arrow**.

3 Disconnect the harness from the Bread Selection Board. Reference the **Blue Arrow**.

4 Remove (2) Phillips Screws and (2) washers, and remove the assembly. Reference the **Green Arrows**.

Replace Control Side Bread Selection Board

5 Install the new Bread Selection Board using (2) Phillips screws and (2) Washers. Previously removed in step 4.

6 Reinstall the wiring harness onto the Bread Selection Board. Previously removed in step 3.

7 Using a Phillips head screwdriver, secure the control side panel. Previously removed in step 2.

8 Plug in unit. Power on and ensure the unit is fully functional.

References

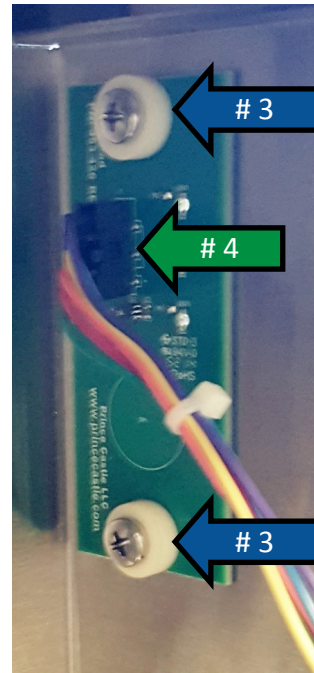

Horizontal Infrared Toaster

IRT-SB-NA-1PS

IRT-SB-NA-3PS

Remove Right Side Bread Selection Board

1 Power off and Unplug the unit



WARNING

Failure to disconnect power from the unit before servicing could result in severe bodily injury or death. The ON/OFF Switch does not disconnect incoming power to the unit.

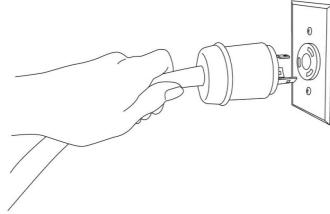

2 Using a Phillips head screwdriver, open the right side panel. Reference the **Red Arrow**.

3 Disconnect the harness from the Bread Selection Board. Reference the **Blue Arrow**.

4 Remove (2) Phillips Screws and (2) washers, and remove the assembly. Reference the **Green Arrows**.

Replace Right Side Bread Selection Board

5 Install the new Bread Selection Board using (2) Phillips screws and (2) Washers. Previously removed in step 4.

6 Reinstall the wiring harness onto the Bread Selection Board. Previously removed in step 3.

7 Using a Phillips head screwdriver, secure the right side panel. Previously removed in step 2.

8 Plug in unit. Power on and ensure the unit is fully functional.

References

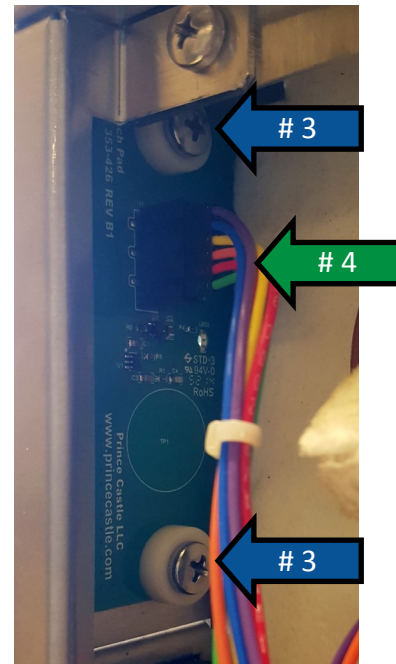

Horizontal Infrared Toaster

IRT-SB-NA-1PS

IRT-SB-NA-3PS



Remove Wire Belt

1 Power off and Unplug the unit



WARNING

Failure to disconnect power from the unit before servicing could result in severe bodily injury or death. The ON/OFF Switch does not disconnect incoming power to the unit.

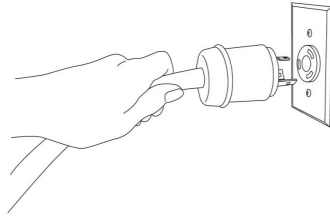

2 Remove the Motor. Reference the motor removal on page 17.

3 Remove the conveyor assembly from the unit by removing (2) Philips screws. Reference the **Red Arrows**.

4 Remove all insulation from the right side of the conveyor assembly.

5 Remove (4) nuts on the right side of the conveyor using an 8mm nut driver. Reference the **Blue Arrows**.

6 Remove (2) Philips screws to free the right side panel of the conveyor assembly. Reference the **Green Ar-**

7 Slide the conveyor belt off of the assembly. Reference figure 1.



Figure 1

Horizontal Infrared Toaster

IRT-SB-NA-1PS

IRT-SB-NA-3PS



Replace Wire Belt

- 8** Slide the conveyor belt back onto the conveyor assembly. Previously removed in step 7
- 9** Re-install the right side panel of the conveyor assembly by securing with (2) Phillips screws. Previously removed in step 6.
- 10** Reinstall (4) nuts on the right side of the conveyor using an 8mm nut driver. Previously removed in step 5.
- 11** Reinstall all insulation on the right side of the conveyor assembly. Previously removed in step 4.
- 12** Install the conveyor assembly onto the unit. Secure using (2) Philips screws. Previously removed in step 3.
- 13** Reinstall the Motor. Reference the motor install on page 17.
- 14** Plug in unit. Power on and ensure the unit is fully functional.

Horizontal Infrared Toaster

IRT-SB-NA-1PS

IRT-SB-NA-3PS



Remove Power Cord

1 Unplug the unit



WARNING

Failure to disconnect power from the unit before servicing could result in severe bodily injury or death. The ON/OFF Switch does not disconnect incoming power to the unit.

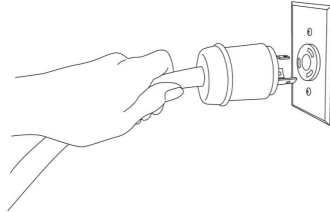

2 Using a Phillips head screwdriver, open the right side panel. Reference the **Red Arrow**.

3 Remove (3) connections from power cord by removing the three screws shown, Reference the **Blue Arrow**.

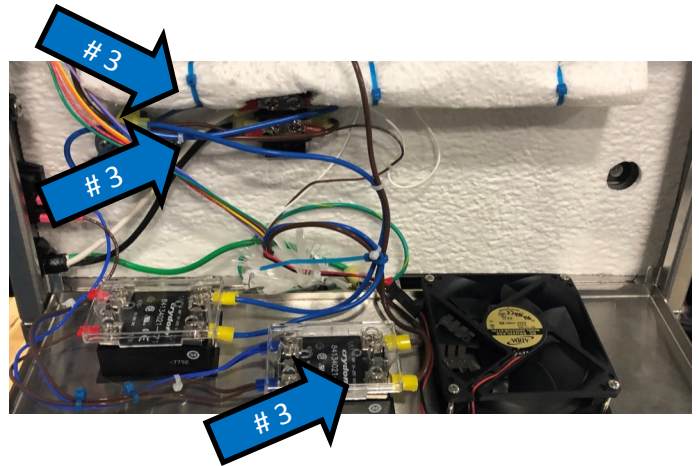

4 Unscrew the back of the strain relief bushing to release the power cord. Remove the power cord from the unit completely. Refer to the **Green Arrow**.

Replace Power Cord

5 Reinstall the power cord onto the unit. Tighten the strain relief bushing. Previously removed in step 4.

6 Reinstall the (3) connections from the power cord on the points shown. Previously removed in step 3.

7 Using a Phillips head screwdriver, reinstall the right side panel. Previously removed in step 2.

8 Plug in unit. Power on and ensure the unit is fully functional.

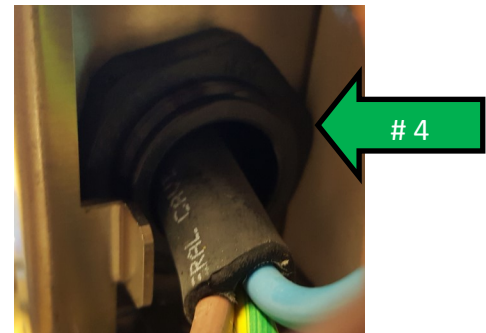

Horizontal Infrared Toaster

IRT-SB-NA-1PS

IRT-SB-NA-3PS

Remove Power Supply

- 1 Power off and Unplug the unit



WARNING

Failure to disconnect power from the unit before servicing could result in severe bodily injury or death. The ON/OFF Switch does not disconnect incoming power to the unit.

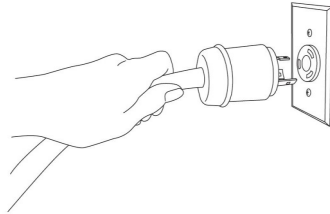

- 2 Using a Phillips head screwdriver, open the control side panel. Reference the **Red Arrow**.

- 3 Remove the (2) connectors from the power supply. Reference the **Blue Arrows**.

- 4 Remove the (4) screws using a Phillips screwdriver to free the power supply. Reference the **Green Arrows**.

Replace Power Supply

- 5 Secure the new power supply by using (4) Phillips screws. Previously removed in step 4.

- 6 Install the (2) connections onto the power supply. Previously removed in step 3.

- 7 Using a Phillips head screwdriver, secure the control side panel. Previously removed in step 2.

- 8 Plug in unit. Power on and ensure the unit is fully functional.

References



Horizontal Infrared Toaster

IRT-SB-NA-1PS

IRT-SB-NA-3PS

Remove Power Switch

1 Power off and Unplug the unit



WARNING

Failure to disconnect power from the unit before servicing could result in severe bodily injury or death. The ON/OFF Switch does not disconnect incoming power to the unit.

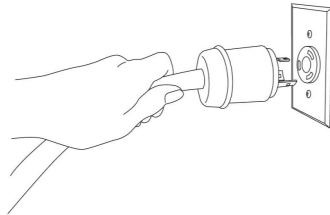

2 Using a Phillips head screwdriver, open the right side panel. Reference the **Red Arrow**.

3 Remove (4) connectors from the power switch. Note the wiring configuration. Reference the **Blue Arrows**.

4 Remove the power switch from the unit. There are two tabs on each side that will need to be released.

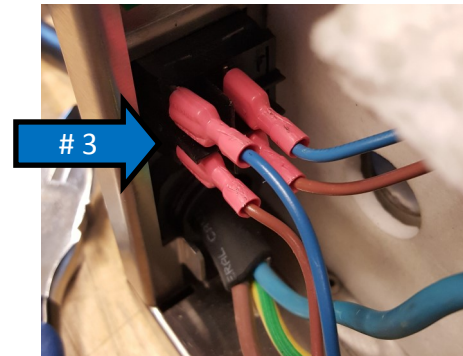

Replace Power Switch

5 Reinstall the power switch. The switch is made to snap in from the outside.

6 Reconnect (4) connectors on the power switch. Refer to step 3 for the wiring orientation.

7 Using a Phillips head screwdriver, secure the right side panel. Previously removed in step 2.

8 Plug in unit. Power on and ensure the unit is fully functional.

Horizontal Infrared Toaster

IRT-SB-NA-1PS

IRT-SB-NA-3PS

Remove Control Side Fan

1 Power off and Unplug the unit



WARNING

Failure to disconnect power from the unit before servicing could result in severe bodily injury or death. The ON/OFF Switch does not disconnect incoming power to the unit.

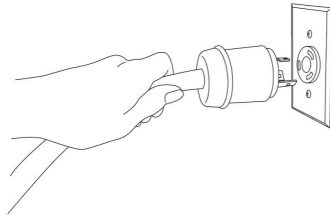

2 Using a Phillips head screwdriver, open the control side panel. Reference the **Red Arrow**.

3 Remove (2) wires from the Axial fan. Note the position of the wiring.

4 Remove (4) Phillips Screws and lift straight up on the fan to remove. Reference the Green Arrows

Replace Control Side Fan

5 Install the fan and secure using (4) Phillips screws in the orientation shown. Previously removed in step 4.

6 Install the (2) wires onto the fan. **Brown= Top.**
Orange/Black= Bottom. Previously removed in step 3.

7 Using a Phillips head screwdriver, secure the control side panel. Previously removed in step 2.

8 Plug in unit. Power on and ensure the unit is fully functional.

References

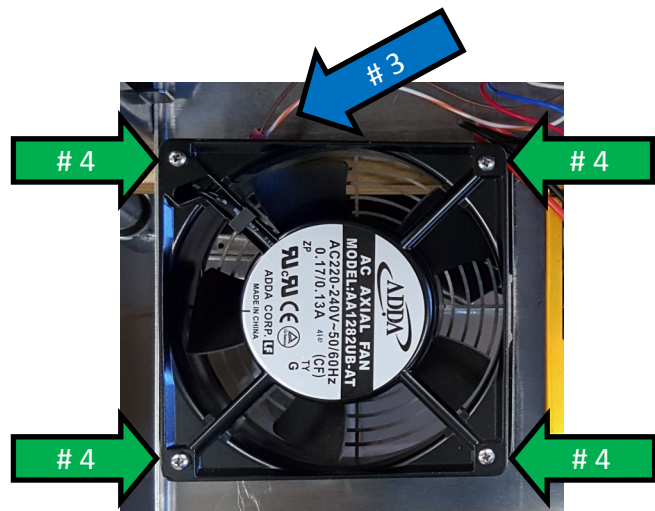
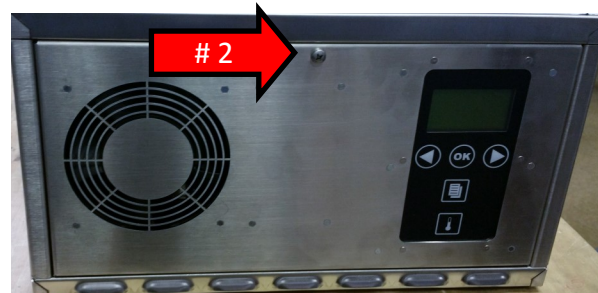

Horizontal Infrared Toaster

IRT-SB-NA-1PS

IRT-SB-NA-3PS



Remove Right Side Fan

1 Power off and Unplug the unit

 **WARNING**

Failure to disconnect power from the unit before servicing could result in severe bodily injury or death. The ON/OFF Switch does not disconnect incoming power to the unit.

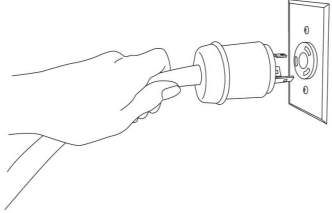

2 Using a Phillips head screwdriver, open the right side panel. Reference the **Red Arrow**.

3 Remove (2) wires from the fan. Note the position of the wiring. Reference the **Blue Arrows**.

4 Remove (4) Phillips Screws and lift straight up on the fan to remove. Reference the **Green Arrows**.

Replace Right Side Fan

5 Install the fan and secure using the (4) Phillips screws. Previously removed in step 4.

6 Install the (2) wires onto the fan. **Brown= Top. Orange/Black= Bottom.** Previously removed in step 3.

7 Using a Phillips head screwdriver, secure the right side panel. Previously removed in step 2.

8 Plug in unit. Power on and ensure the unit is fully functional.

References

