

Operation Manual

**Product Holding Bin
DHB3PT-33BK**
(with Prince Castle Button Bar)



LIMITED WARRANTY

This product is warranted to be free from defects in material and/or workmanship for a period of 1 year from date of original installation, not to exceed 18 months from the date of manufacture.

Any component which proves to be faulty in material and/or workmanship will be replaced or repaired (at the option of Prince Castle, Inc.) without cost to the customer for parts and labor. This warranty covers on location service (i.e. trip charges and or mileage). Travel mileage is limited to 100 miles (200 Kilometers) round trip (one trip warranty) from an authorized service agency or its sub-service agency.

This warranty is subject to the following exceptions/conditions:

- Use of any non-genuine Prince Castle parts voids this warranty.
- All labor to be performed during regular work hours. Overtime premium (the incremental amount) will be charged to the customer.
- Damage caused by carelessness, neglect and/or abuse (e.g., dropping, tampering or altering parts, equipment damaged in shipment, by fire, flood or an act of God) is not covered under this warranty.
- All problems due to operation at voltages other than that specified on equipment nameplates are not covered by this warranty. Conversion to correct voltage is the customer's responsibility.
- This equipment must be serviced by Prince Castle Authorized Service Agency or a Prince Castle Service Technician during the warranty period.

TABLE OF CONTENTS

Safety Information	2
Electrical Specifications	2
Product Identification	2
Installation	3
Operation	3
Cleaning	5
Setting the Temperature	5
Calibrating Heaters	6
Selecting Breakfast and Regular Menus	7
Programming the Menus	7
Changing the Hold and Cook-More Times	8
Changing Product Names	9
Factory Presets	10
Troubleshooting	11
Wiring Diagram	11
Exploded View and Parts List	12

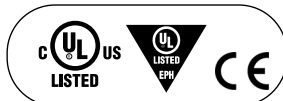

PRINCE CASTLE LLC
WORLDWIDE



A Marmon Group / Berkshire Hathaway Company

355 East Kehoe Blvd. • Carol Stream, IL 60188 USA
Telephone: 630-462-8800 • Toll Free: 1-800-PCASTLE
Fax: 630-462-1460 • www.princecastle.com

Product Holding Bin DHB3PT-33BK

Safety Information

WARNING

Indicates information important to the proper operation of the unit. Failure to observe may result in damage to the equipment and/or severe bodily injury or death.

CAUTION

Indicates information important to the operation of the unit. Failure to observe may result in damage to the equipment.

Electrical Specifications

Model No.	Volts	Watts	Hz
DHB3PT-33BK	208 – 240	2140 – 2850	50/60

Product Identification

Components

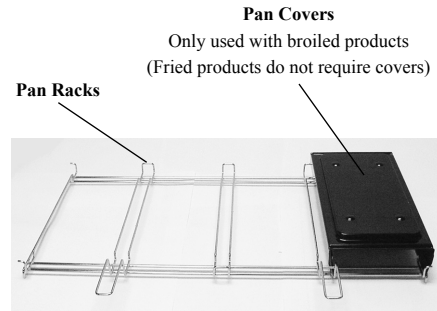

Upper Button Bar

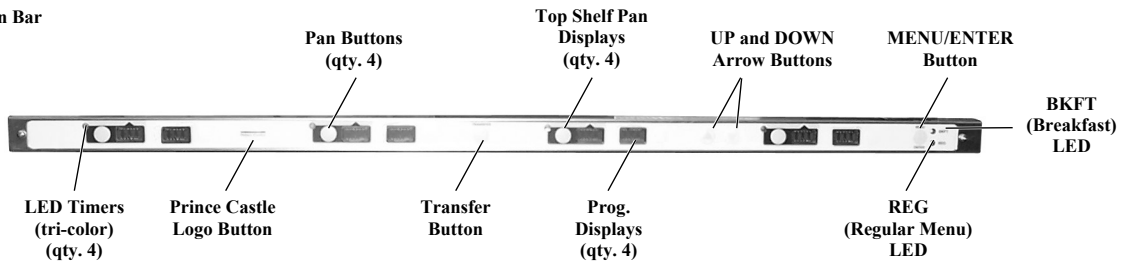

Lower Button Bar

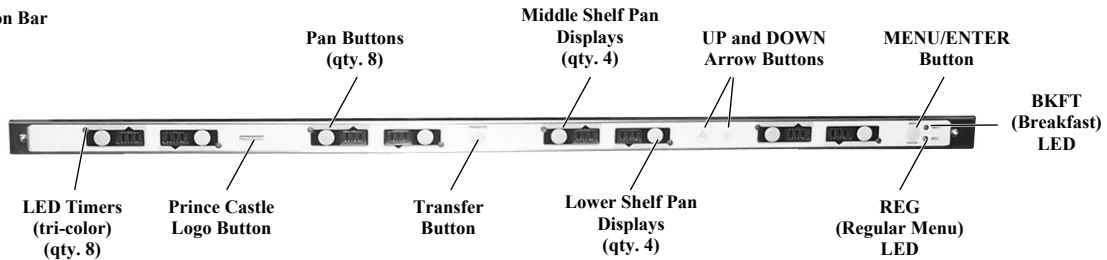

Important

Prince Castle reserves the right to change specifications and product design without notice. Such revisions do not entitle the buyer to corresponding changes, improvements, additions or replacements for previously purchased equipment.

Installation

Remove the unit from the carton and inspect for signs of damage. If there is damage to the unit:

- notify the carrier within 24 hours of delivery
- save carton and packaging materials for inspection purposes
- contact your local dealer, or if purchased directly, the Prince Castle Sales Department at 800-722-7853 or 1-630-462-8800 to arrange for a replacement unit.

Verify that the following parts have been received.

- 1 pan cover kit

NOTE: When installing this unit, the ambient temperature at the mounting site should not exceed 100°F (38°C).

Plug the power cord into the proper electrical receptacle. All electrical connections must be in accordance with local electrical codes and any other applicable codes.

WARNING

All electrical connections must be in accordance with local electrical codes and any other applicable codes.

If the supply cord is damaged, it must be replaced by the manufacturer, its service agent, or similarly qualified persons in order to avoid a hazard.

To prevent an electric shock hazard this device must be bonded to equipment in close proximity with an equipotential bonding conductor. This device is equipped with a grounding lug for this purpose and is marked with the following symbol.



Operation

WARNING

This application is not intended for use by persons (including children) with reduced physical, sensory, or mental capabilities, or lack of experience and knowledge unless they have been given supervision or instruction concerning use of the appliance by a person responsible for their safety.

- 1 Turn power On/Off switch (A) to ON position.

Load pan covers (if used) onto pan racks and insert racks into the unit.

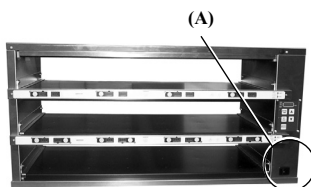

Allow 20 minutes for heaters to reach operating temperature.

- 2 Press all PAN buttons.
The PAN displays will show the assigned product name.

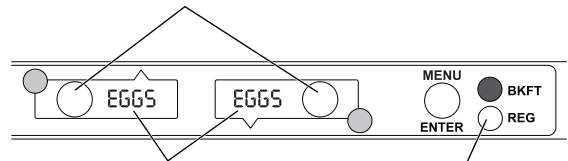

If no product is assigned, the display will be dim and show "----". Pressing the PAN button will not activate the timer if "----" is displayed. Pressing PAN button when product name is displayed will start timing cycle.

BKFT (Breakfast) or REG (Regular Menu) will be lit depending on pre-programmed menu.

- 3 LED Timing Status



LED Timers

- RED (steady) = Ready for product
- RED (flashing) = Discard product
- GREEN (steady) = Oldest product, use first
- GREEN (flashing) = Cook more product
- YELLOW (steady) = Newer product, use green first
- YELLOW (flashing) = Cook more product

- 4 When LED is steady RED, load product and press the PAN button.
If more than one pan is active for a product, the LED for the first pan loaded will turn from RED to GREEN.

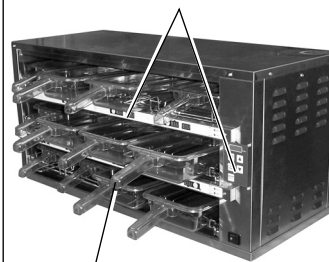

The LED for the 2nd pan loaded with the same product will turn from RED to YELLOW.

An LED timer can be stopped (cancelled) at any time by pressing and releasing the corresponding PAN button.

If only one pan is active for a product, the LED will turn from RED to GREEN.

Operation (continued)

5 When any of the timer LEDs flash, cook more product or remove and discard product as indicated.



GREEN (flashing) = Cook more product
YELLOW (flashing) = Cook more product
RED (flashing) = Discard product

 **WARNING**
Hot surfaces.

6 Product, along with any remaining time, can be transferred from one cavity to another as follows:

A. Press and release the TRANSFER button on the button bar of the product to be moved. All displays will flash between bright and dim.

C. Press and release the TRANSFER button on the button bar to which the product will be moved. Available locations will flash.

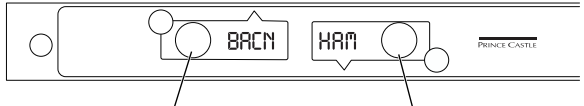

B. Press and release the PAN button of the product to be moved. All displays except this one will stop flashing.

D. Move the product. Press and release the PAN button for the new location. The new location will finish timing the product. When the transferred pan timing expires, location will revert to original menu setting.

NOTE: If product transfer is not completed within a pre-programmed transfer time, the transfer will be cancelled. See your Manager.

7 To change a menu selection for a specific pan cavity, use the following steps:

A. Press and hold the PRINCE CASTLE LOGO button for 6 seconds. All PAN displays on the button bar will show PROG. All LED Timers on the button bar will be RED.

D. Press the UP or DOWN Arrow button to scroll to the desired menu item.

E. Press the MENU/ENTER button to select the menu item.

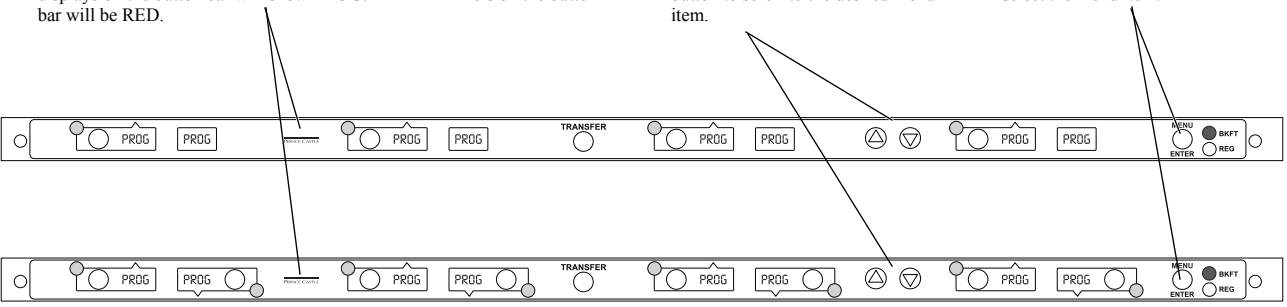

B. Press and hold the button bar's MENU/ENTER button. The display next to the MENU/ENTER button will display the menu choices. While holding the MENU/ENTER button, press the UP or DOWN Arrow button to scroll through the menu choices.

C. Press a PAN button to change the menu. The LED Timer will change to YELLOW and the display will change from PROG to the assigned menu item.

F. Repeat steps A – E as required for other PAN displays. Press the PRINCE CASTLE LOGO button to exit the Program Mode.

NOTE: Up to six menu items may be programmed for each PAN button. In addition, a pan may be set as "not used" by assigning "----" as its product.

NOTE: On the top button bar, only the displays with PAN buttons can be programmed and will have menu items. They are for the Top Shelf Pans.

Operation (continued)

- 8** To shut down the unit, turn the power On/Off switch (A) to OFF.



Cleaning

WARNING

Before performing any maintenance, turn the power switch to the OFF position and unplug the power cord from the electrical receptacle.

CAUTION

This unit is not watertight. Do not clean with a water jet/jet spray. Do not immerse the unit in water.

1. Turn the unit off and unplug the power cord from the electrical receptacle.
2. Remove the pan covers and pan racks. Wipe all parts and unit with a damp cloth. DO NOT use a green Scotch Bright pad cleaner, ice or water.

Setting the Temperature

- 1** The unit has three shelves, each with an upper and lower heater (six heaters total).
The factory pre-set for the three upper heaters is 225°F (107°C).
The factory pre-set for the three lower heaters is 195°F (91°C).
Each heater has a programmable range of 150° – 275°F (66 – 135°C).
Use the control below and the following steps to set the setpoint temperatures for each heater.

UPPER LED
This LED will be lit to indicate upper heater is selected.

PROG LED
This LED will be lit to indicate unit is in Program Mode.

LOWER LED
This LED will be lit to indicate lower heater is selected.

ACTUAL TEMP BUTTON and LED
Press to display actual temperature for the selected heater. LED will be lit when actual temperature is displayed.

SETPOINT BUTTON and LED
Press to display setpoint temperature of a selected heater. LED will be lit when setpoint temperature is displayed.

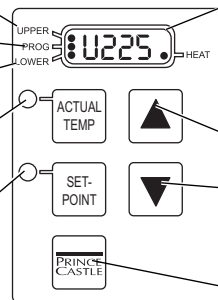

TEMPERATURE DISPLAY
A = Top Shelf
B = Middle Shelf
C = Lower Shelf

NOTE: The unit is preset to display temperature in Fahrenheit. To display in Celsius, press and hold the DOWN Arrow button immediately after turning on the power switch. To switch back to Fahrenheit, press and hold the UP Arrow button after turning on the power switch.

UP/DOWN ARROW BUTTONS
Used with other Buttons to scroll through heater and shelf/temperature selections.

PRINCE CASTLE LOGO BUTTON
Press to enter temperature selections.

CAUTION
DISPLAYED TEMPERATURES ARE HEATER TEMPERATURES AND DO NOT INDICATE ACTUAL FOOD TEMPERATURES.

NOTE: To reset all times and temperatures to the factory settings, turn the unit off, then press and hold the UP and DOWN Arrow buttons simultaneously while turning the unit back on. A "P" will appear in the display and all times and temperatures will be reset to original factory settings.

Setting the Temperature (continued)

- 2** Press the UP or DOWN Arrow button until the desired shelf/temperature (A, B, C) and upper or lower heater LED is selected.

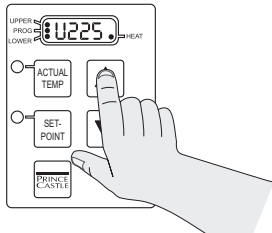

- 3** Press and hold the SETPOINT button and the PRINCE CASTLE LOGO button for 5 seconds. The Program LED will light.

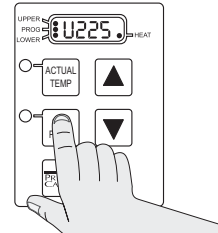

- 4** Press the UP or DOWN Arrow button until the desired setpoint temperature is displayed.

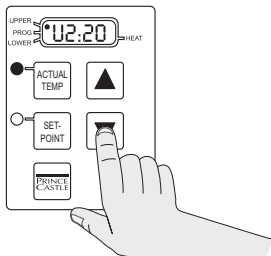

- 5** Press the PRINCE CASTLE LOGO button to save the new setpoint value. Repeat Steps 2 – 5 to change the setpoint for any other heater.

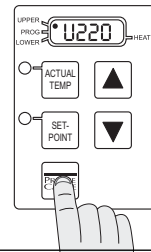

Calibrating Heaters

- 1** Use the following steps to calibrate the individual heaters.

NOTE: Allow sufficient amount of time for temperatures to stabilize before starting calibration.

Press the UP or DOWN Arrow button until the desired shelf/temperature (A, B, C) and upper or lower heater LED is selected.

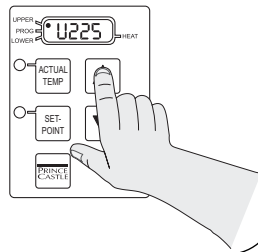

- 2** Take a temperature reading within the shelf near the center of the heater surface.

Use a stand-alone temperature meter (not supplied).



WARNING

Hot surfaces. Use caution when taking temperature readings within the shelf.



- 3** A. Press and hold the PRINCE CASTLE LOGO and ACTUAL TEMP buttons for 5 seconds. The colon (:) LED indicator will light. The temperature displayed is the actual heater temperature sensed by the controller.
B. To clear any offset readings, press the SETPOINT button.

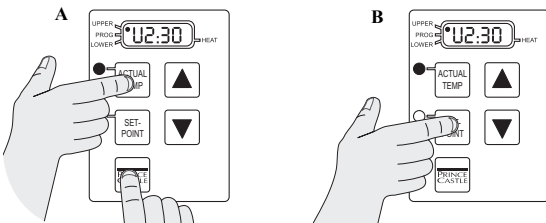

- 4** A. Press the UP or DOWN Arrow button until the temperature displayed matches the reading obtained in Step 2.
B. Press the PRINCE CASTLE LOGO button to save the temperature value and exit the Calibration Mode.

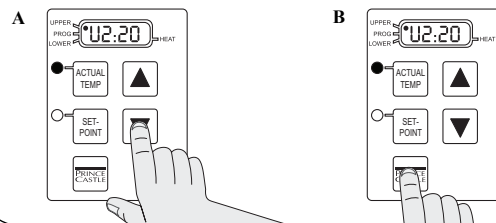

Selecting Breakfast and Regular Menus

1 There are six menus available:
BKFT LED ON = Breakfast1 or Breakfast2
REG LED ON = Regular1, Regular2, Regular3, or Regular4
Press and hold the MENU/ENTER button, then use the UP or DOWN Arrow button to scroll through the 6 menus.

When scrolling, menus appear in this display.

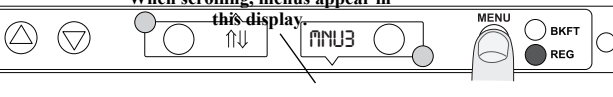

2 When the desired menu is displayed, release the MENU/ENTER button. The food products for the menu will be displayed in the PAN displays.

When you change to a new menu, any timers started before the change will flash the product name from the previous menu. Press the PAN button next to the flashing display to cancel the timer and stop the display from flashing.



Programming the Menus

1 Press and hold the PRINCE CASTLE LOGO button (on the button bar) until all the displays show PROG and the PAN buttons LEDs all glow RED.



2 Press and hold the MENU/ENTER button, then use the UP or DOWN Arrow button to scroll through the 6 menus. Release the MENU/ENTER button when the desired menu is displayed.



When the MENU/ENTER button is released, all displays will again show PROG.



3 Press the PAN button next to the display to be changed. The LED will change from RED to YELLOW and the display will change from PROG to the assigned menu item.



Press the UP or DOWN Arrow button to scroll to the desired product. Press the MENU/ENTER button to save the selection. All other displays will show PROG.



4 Repeat Steps 2 – 3 as required. Press the PRINCE CASTLE LOGO button to exit the Program Mode.

NOTE: A pan may be set as "not used" by assigning "--" as its product.



Changing the Hold and Cook-More Times

- The SET PRODUCT TIME menu is used to change the Hold and Cook-More times.
Press and hold the PRINCE CASTLE LOGO button, then immediately press and hold the MENU/ENTER button until the display shows one of four programming menus.
Use the UP or DOWN Arrow button to scroll to the SET PROD TIME ↑ ↓ ENTR (Set Product Time) menu.

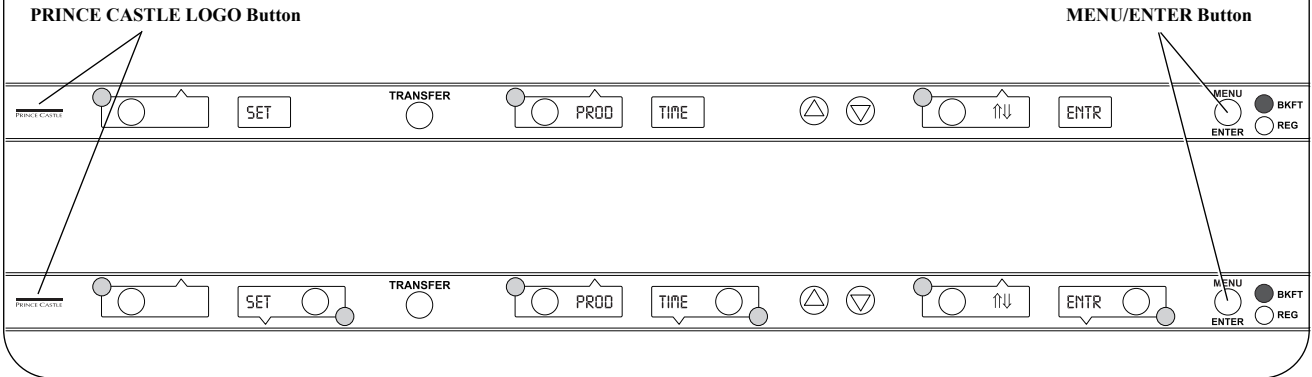

- Press and release the MENU/ENTER button to enter the Set Product Time menu. The display will show, for example, SET EGGS TIME ↑ ↓ ENTR.
Use the UP or DOWN Arrow button to scroll through the list of products. When the desired product is displayed, press the MENU/ENTER button to select it.



NOTE: Holding the UP or DOWN Arrow button for longer than 2 seconds will cause the product list to automatically scroll up or down.

- The display will show the current Hold time.

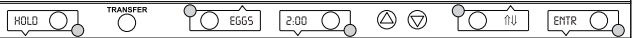

Use the UP or DOWN Arrow button to scroll to the desired Hold time. When the desired Hold time is displayed, press the MENU/ENTER button to save the desired Hold time.



NOTE: Hold time cannot be reduced to less than the Cook-More time plus one minute.

- The display will now show cook EGGS :07 ↑ ↓ ENTR (the Cook-More time).

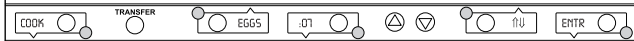

Use the UP or DOWN Arrow button to scroll to the desired Cook-More time. When the new desired Cook-More time is displayed, press the MENU/ENTER button to save it.

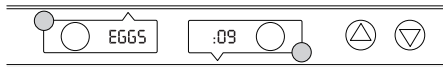

NOTE: Cook-More time cannot be increased to more than the Hold time plus one minute.

- The display will show SET PROD TIME ↑ ↓ ENTR. Repeat Steps 2 – 4 for any other product.
Press and release the PRINCE CASTLE LOGO button at any time to exit the Program Mode and return to the Run Mode.

NOTE: If the MENU/ENTER button has not been pressed to save any changes, the program will revert to the original values.



Changing Product Names

- 1 The EDIT PRODUCT NAME menu is used to change a default product name to one of your own choosing.
Press and hold the PRINCE CASTLE LOGO button, then immediately press and hold the MENU/ENTER button until the display shows one of four programming menus.
Use the UP or DOWN Arrow button to scroll to the SEL PROD xxxx ↑ ↓ ENTR (Edit Product Name) menu.

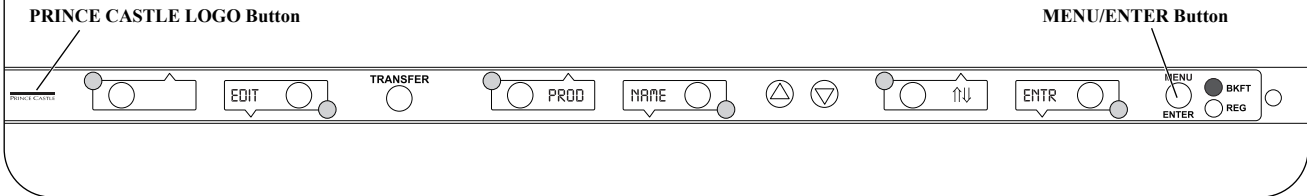

- 2 Press and release the MENU/ENTER button to enter the Edit Product Name menu.
Use the UP or DOWN Arrow button to scroll through the list of products. When the desired product is displayed, press the MENU/ENTER button to select it.
The first letter (in this case, the E) will start blinking.

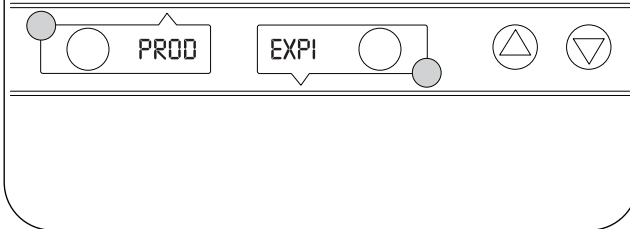

- 3 To change the blinking E, use the UP or DOWN Arrow button to scroll to the desired letter/number/symbol. When the desired selection is displayed, press the PAN button to move to the next digit. Repeat for all digits.

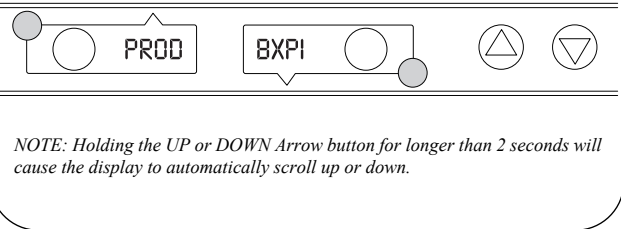

NOTE: Holding the UP or DOWN Arrow button for longer than 2 seconds will cause the display to automatically scroll up or down.

- 4 When all four digits have been changed, press the MENU/ENTER button to select the new name.

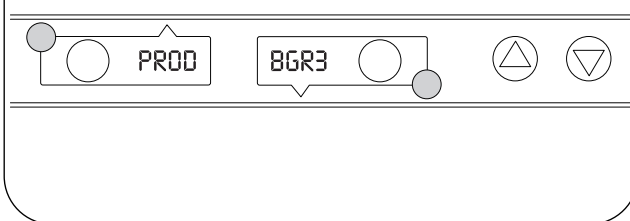

- 5 The display will show edit prod name ↑ ↓entr. Repeat Steps 2 – 4 for any other product.
Press and release the PRINCE CASTLE LOGO button at any time to exit the Program Mode and return to the Run Mode.
NOTE: If the MENU/ENTER button has not been pressed to save any changes, the program will revert to the original names.

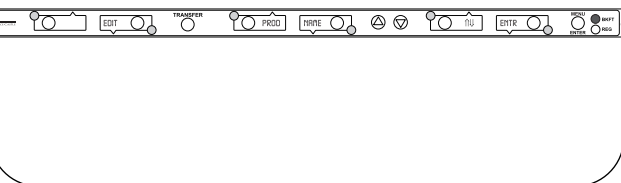

Factory Presets

Product Menu Details

Product	Display Name	Hold Minutes ¹	Cook-More Minutes ¹
Eggs	EGGS	45	6
Biscuits	BISC	60	17
Sausage	SAUS	60	1
French Toast	FR-T	30	2
Ham	HAM	120	2
Fish	FISH	45	4
Chicken Crisp	CRSP	45	3
Chick Patty	CHKN	60	4
Chicken Tenders	TEND	30	3
Burgers	BURG	60	3
Whoppers	WHPR	45	3
BK Broiler	-BK-	60	6
Bacon	BACN	120	2
Poppers	POP	30	2
Mozzarella Stick	MOZ	30	2
Spicy Chicken Wings	SPCY	60	3
Fried Egg	F-EG	60	6
Experimental #1	EXP1	60	2
Experimental #2	EXP2	60	2
Experimental #3	EXP3	60	2
Experimental #4	EXP4	60	2
Experimental #5	EXP5	60	2
Experimental #6	EXP6	60	2
Experimental #7	EXP7	60	2
Experimental #8	EXP8	60	2

Hold and Cook-More times may be re-programmed. See page 8.

Menus: Bottom Button Bar

Timer 8	Timer 7	Timer 6	Timer 5	Timer 4	Timer 3	Timer 2	Timer 1	Menu	Indicator
BACN	HAM	FR-T	SAUS	BISC	EGGS	EGGS	EGGS	MNU1	Bkft
WHPR	WHPR	WHPR	WHPR	BURG	BURG	BURG	BURG	MNU2	Reg
TEND	TEND	CHKN	CHKN	CRSP	CRSP	FISH	FISH	MNU3	Reg
WHPR	WHPR	WHPR	WHPR	BURG	BURG	BURG	BURG	MNU4	Reg
SPCY	SPCY	MOZ	MOZ	POP	POP	-BK-	-BK-	MNU5	Reg
BACN	HAM	FR-T	SAUS	BISC	EGGS	EGGS	EGGS	MNU6	Bkft

Menus: Top Button Bar

Timer 8	Timer 7	Timer 6	Timer 5	Timer 4	Timer 3	Timer 2	Timer 1	Menu	Indicator
BACN	-----	FR-T	-----	BISC	-----	EGGS	-----	MNU1	Bkft
WHPR	-----	WHPR	-----	BURG	-----	BURG	-----	MNU2	Reg
TEND	-----	CHKN	-----	CRSP	-----	FISH	-----	MNU3	Reg
WHPR	-----	WHPR	-----	BURG	-----	BURG	-----	MNU4	Reg
SPCY	-----	MOZ	-----	POP	-----	-BK-	-----	MNU5	Reg
BACN	-----	FR-T	-----	BISC	-----	EGGS	-----	MNU6	Bkft

Troubleshooting

PROBLEM	PROBABLE CAUSE	SOLUTION
Display flashes OpN and REL.	Open relay. Circuit inoperable.	Replace main PCB
Display flashes SHR and REL.	Shorted relay. Circuit inoperable. Open heater. Unplugged ribbon cable between power and main circuit boards.	Replace main PCB. Test heater resistance (150.2 Ohms). Replace heater if necessary. Verify ribbon cable connection.
Display flashes OPN and REL.	Temperature is below 75°F (24°C). Heater inoperable. Probe inoperable. Relay inoperable.	Normal display during warmup. Test heater resistance (150.2 Ohms). Check for open thermocouple wires from probe. Replace heater/probe assembly. Replace main PCB.
Display shows HHH for an extended period of time and heater surface temperature is hot.	Temperature is above 300°F (149°C) (abnormal operation).	Diagnostic circuit inoperable. Replace main PCB.
Display shows HHH for an extended period of time and heater surface temperature is cool.	Probe is inoperable.	Check for pinched thermocouple wires from probe. Replace heater/probe assembly.

Wiring Diagram

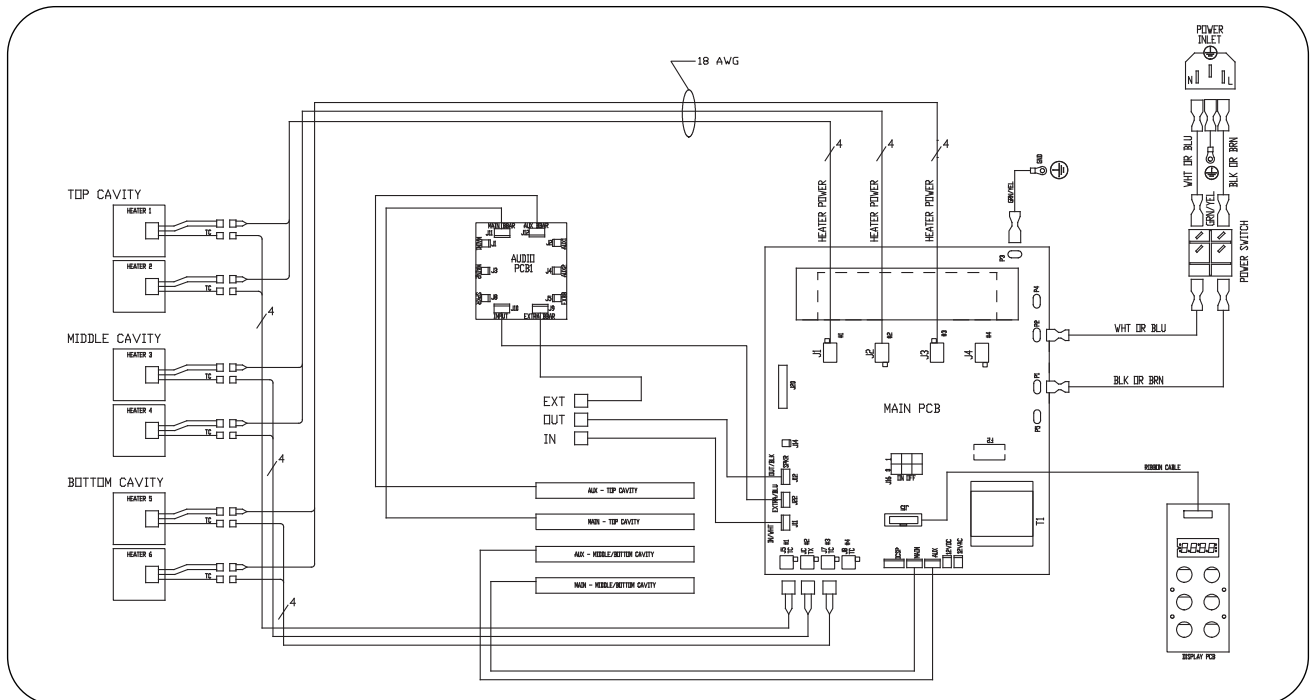

Exploded View and Parts List

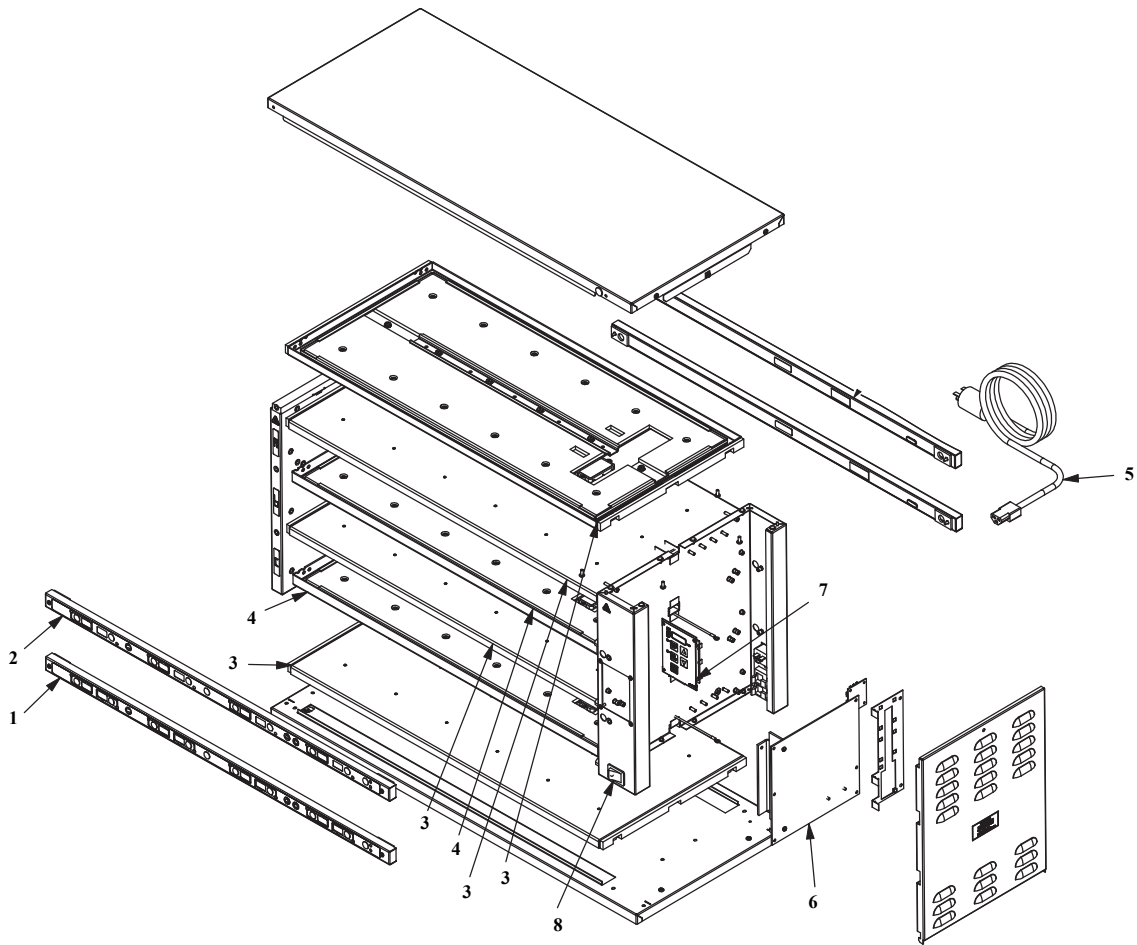

Ref.	Part No.	Description	Ref.	Part No.	Description
1	541-TSMCS	Main Timer Bar Kit	5	72-200-25S	Power Cord
2	541-1207S	Main Upper Timer Bar Kit	6	541-1220S	Main Brd Kit (-33BK)
3	540-834S	Lower Heater Kit	7	541-719S	Display Brd Kit
4	540-833S	Upper Heater Kit	8	78-184S	Power Switch

PRINCE CASTLE LLC 
WORLDWIDE

 A Marmon Group/Berkshire Hathaway Company

355 East Kehoe Blvd. • Carol Stream, IL 60188 USA

Telephone: 630-462-8800 • Fax: 630-462-1460

Toll Free: 1-800-PCASTLE

www.princecastle.com