

Operation Manual

Product Holding Bin
DHB2PT-33KFCB Series

Product Identification

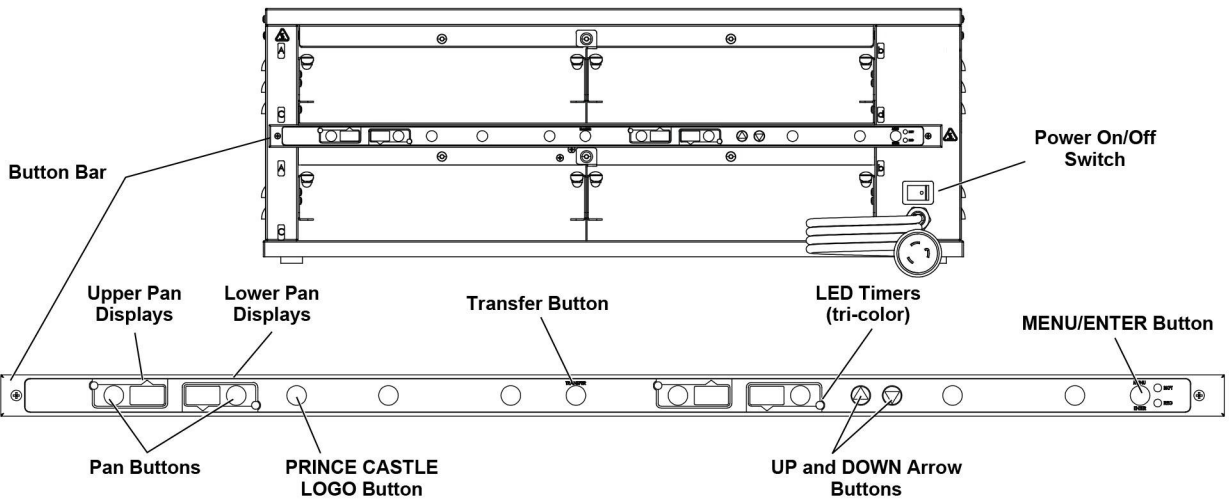

NOTE: No timer bars on models DHB2PT-33KFCCEN and DHB2PT-46KFCCEN. Four (4) high temperature amber pans 12" x 20" x 2-1/2" and covers not included.

LIMITED WARRANTY

This product is warranted to be free from defects in material and/or workmanship for a period of 1 year from date of original installation, not to exceed 18 months from the date of manufacture.

Any component which proves to be faulty in material and/or workmanship will be replaced or repaired (at the option of Prince Castle, Inc.) without cost to the customer for parts and labor. This warranty covers on-location service (i.e. trip charges and/or mileage). Travel mileage is limited to 100 miles (200 Kilometers) round trip (one trip warranty) from an authorized service agency or its sub-service agency.

This warranty is subject to the following exceptions/conditions:

- Use of any non-genuine Prince Castle parts voids this warranty.
- All labor to be performed during regular work hours. Overtime premium (the incremental amount) will be charged to the customer.
- Damage caused by carelessness, neglect and/or abuse (e.g., dropping, tampering, or altering parts, equipment damaged in shipment, by fire, flood or an act of God) is not covered under this warranty.
- All problems due to operation at voltages other than that specified on equipment nameplates are not covered by this warranty. Conversion to correct voltage is the customer's responsibility.
- Normal adjustments as outlined in this manual are not covered under warranty.
- This equipment must be serviced by Prince Castle Authorized Service Agency or a Prince Castle Service Technician during the warranty period.

TABLE OF CONTENTS

Product Identification	1
Safety Information	2
Electrical Information	2
Installation	2
Initial Startup	4
Resetting to Factory Defaults	4
Operation	4
Time Declination Feature	5
Cleaning	6
Setting Temperature	6
Calibrating Heaters	7
Programming the Menus	8
Changing the Hold and Cook-More Times	9
Setting the Alternating Display Interval	9
Changing Product Names	10
Set Maximum Transfer Time and Volume	11
Changing Temperature Scale	12
Default Menu	13
Boot Loader	14



PRINCECASTLE

AMARION FOODSERVICE TECHNOLOGIES
A HERSHEY HARTMAN COMPANY

355 East Kehoe Blvd. • Carol Stream, IL 60188 USA
Telephone 630-462-8800 • Fax: 630-462-1460
Toll Free: 1-800-PCASTLE
www.princecastle.com

Safety Information



WARNING

Indicates information important to the proper operation of the unit. Failure to observe may result in damage to the equipment and/or severe bodily injury or death.



CAUTION

Indicates information important to the operation of the unit. Failure to observe may result in damage to the equipment.

Electrical Information

Model	Volts	Hz	Watts	Amps	Plug	Agency
DHB2PT-33WS	208	60	3200	15.4	L6-20P	UL / cUL / UL Sanitation
DHB2PT-33KFCB	208	60	3200	15.4	L6-20P	UL / cUL / UL Sanitation
DHB2PT-33KFC	208	60	3200	15.4	L6-20P	UL / cUL / UL Sanitation
DHB2PT-46KFC	208	60	4800	23.1	L6-30P	UL / cUL / UL Sanitation
DHB2PT-33KFCCE	220-240	50/60	4300 Max.	17.8 Max.	IEC309	CE / UL Sanitation
DHB2PT-46KFCCE	220-240	50/60	6400 Max.	26.7 Max.	IEC309	CE / UL Sanitation
DHB2PT-33KFCCEL	220-240	50/60	4300 Max.	17.8 Max.		CE / UL Sanitation
DHB2PT-46KFCCEL	220-240	50/60	6400 Max.	26.7 Max.		CE / UL Sanitation
DHB2PT-33KFCCEEN	220-240	50	4300	17.8		
DHB2PT-33KFCCKT1	208	60	3200	15.4		
DHB2PT-33KFCCKT2	208	60	3200	15.4		
DHB2PT-46KFCCEEN	220-240	50	6400	26.7		
DHB2PT-46KFCF12	208	60	4800	23.1	L6-30P	
DHB2PT-46KFCCEDE	220-240	50/60	6400 Max.	26.7 Max.	IEC309	CE / UL Sanitation
DHB2PT-33KFCCEDE	220-240	50/60	4300 Max.	17.8 Max.	IEC309	CE / UL Sanitation
DHB2PT-46KFCCEEA	220/240	50/60	4300 Max.	17.8 Max.	IEC309	CE / UL Sanitation

Installation

A. Remove the unit from the carton and inspect for signs of damage. If there is damage to the unit:

- notify the carrier within 24 hours of delivery
- save carton and packaging materials for inspection purposes
- contact your local dealer, or if purchased directly, the Prince Castle Sales Department at 800-722-7853 or 1-630-462-8800 to arrange for a replacement unit.

NOTE: When installing this unit, the ambient temperature at the mounting site should not exceed 100°F (37.8°C).

B. Plug the power cord into the bin and connect the plug into the proper electrical outlet. All connections must be in accordance with local electrical codes and any other applicable codes.

NOTE: The electrical receptacle should be a dedicated outlet. No other equipment should be operating on the line (refrigerators, fryers, etc.).

C. Turn the power switch to ON. Allow 30 minutes for warm-up.

Prince Castle reserves the right to change specifications and product design without notice. Such revisions do not entitle the buyer to corresponding changes, improvements, additions or replacements for previously purchased equipment.

Initial Startup

NOTE: During the first few hours of operation, you may notice a faint odor. This is normal, and the odor disappears after the first few hours of use.

The bin is tested and calibrated at the factory before shipment. However, due to temperature and climate changes during shipment, the insulation in

bin can absorb moisture. The odor during the first few hours of use is from the drying out of the insulation (moisture is driven from the insulation's binders, a starch-like material).

Resetting to Factory Defaults

To revert all settings back to the original factory defaults (product times on button bars):

1. Turn the unit off.
2. Press and hold both UP and DOWN arrows.
3. Turn the unit back on and wait 5 seconds.

4. Release UP and DOWN arrows.

NOTE: All previously saved settings are lost upon resetting the defaults! Use with caution.

Operation

- 1 Turn power On/Off switch to ON position.

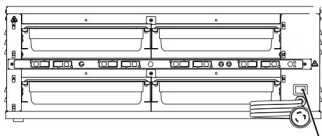

Power On/Off Switch

Allow **30 minutes** for heaters to reach operating temperature. The Temperature Display will show temperature as unit warms up to the operating temperature.

- 2 Press PAN Buttons.



The PAN DISPLAYS will show the assigned product name.

If no product is assigned, the display will be blank. Pressing the PAN button will not activate the timer if the display is blank. Pressing PAN button when product name is displayed will start timing cycle.

- 3 LED Timing Status



LED Timers

- RED (steady) = Ready for product
- RED (flashing) = Discard product
- GREEN (steady) = Oldest product, use first
- GREEN (flashing) = Cook more product
- YELLOW (steady) = Newer product, use green first
- YELLOW (flashing) = Cook more product

- 4 When LED is steady RED, load product and press the PAN button.

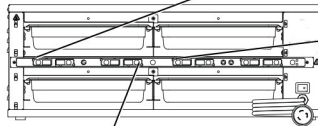

If no other pan is active for a product, the LED for the first pan loaded will turn from RED to GREEN.

The LED for the 2nd pan of the same product (3rd pan, etc.) loaded will turn from RED to YELLOW.

If only one pan is active for a product, the LED will turn from RED to GREEN.

An LED timer can be stopped (cancelled) at any time by pressing and releasing the corresponding PAN button quickly 3 times.

Operation (continued)

- 5** When any of the timer LEDs flash, cook more product or remove and discard product as indicated.

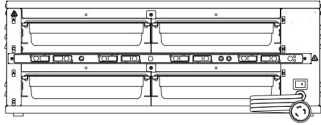

GREEN (flashing) = Cook more product
YELLOW (flashing) = Cook more product
RED (flashing) = Discard product

WARNING
 Hot surfaces.

- 6** Product, along with any remaining time, can be transferred from one cavity to another as follows:

- A. Press and release the **TRANSFER** button. Displays for available bins are brightly lit. Displays for bins currently not timing, are dimly lit.
- C. Move the product. Press and release the **TRANSFER** button again.

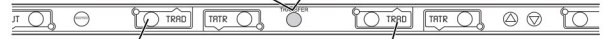

- B. Press and release the **PAN** button of the product to be moved.
- D. Press and release the **PAN** button for the new location. The new location will finish timing the product. When the transferred pan timing expires and/or is cancelled, the location will revert to original menu setting.

NOTE: If product transfer is not completed within a pre-programmed transfer time, the transfer will be cancelled. See your Manager.

- 7** To shut down the unit, turn the power On/Off switch to OFF.

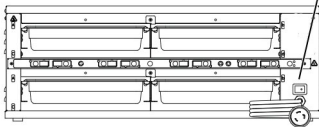

Time Declination Feature

To adjust Hold time when starting a timer:

- A. Press and hold the timer button.
 B. Press the UP or DOWN Arrow button to adjust the Hold time.

NOTE: This adjustment must be done within the first 5 seconds.

NOTE: The range of adjustment cannot be larger than the default hold time or smaller than the default cook time.

To cancel at any time, press and release the corresponding **PAN** button quickly 3 times.

Cleaning



CAUTION

This unit is not watertight. Do not clean with a water jet/jet spray. Do not immerse the unit in water.

1. Turn the unit off and unplug the power cord from the electrical receptacle.
2. Wipe all parts and unit with a damp cloth. DO NOT use a green Scotch Bright pad cleaner, ice or water.

Setting Temperature

- 1** A. Press and hold the PRINCE CASTLE LOGO button, then immediately press and hold the MENU/ENTER button until the display shows one of the programming menus.

NOTE: All channels must be in an idle state to get into the program mode.

- B. Use the UP or DOWN arrow button to scroll to the PROD TEMP menu.

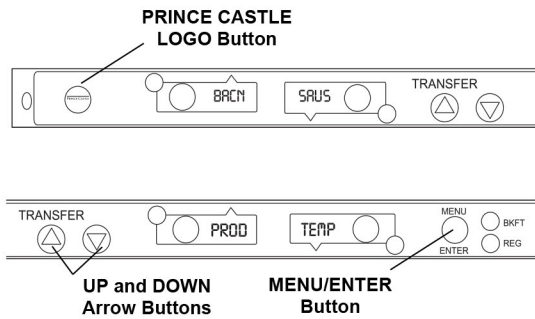

- 2** A. Press and release the MENU/ENTER button to enter the Set Product Temperature menu. The display will show, for example, EGG.

- B. Use the UP or DOWN arrow buttons to scroll through the list of products. When the desired product is displayed, press the MENU/ENTER button to select it.

Refer to the Product Menu Details on page 13 for a list of products and their corresponding display names.

NOTE: Holding the UP or DOWN arrow buttons for longer than 2 seconds will cause the list to automatically scroll up or down.

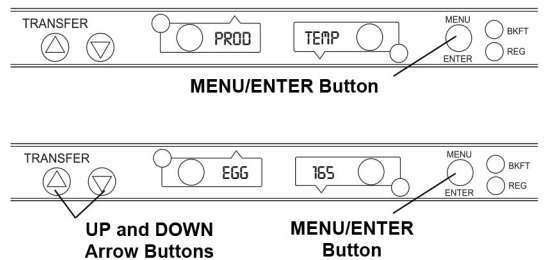

- 3** The current heater set point temperature for the chosen product will show in the display.

Use the UP or DOWN arrow button to change the heater temperature.

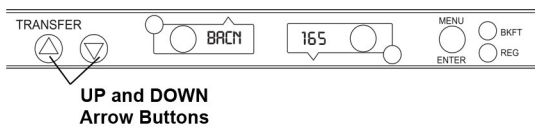

- 4** A. Press and release the MENU/ENTER button to save the changes.

- B. The display will show PROD TEMP. Repeat steps 1 thru 4 to change the temperature on any other products.

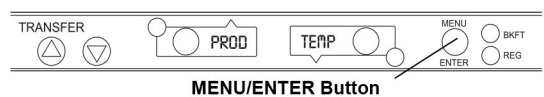

CAUTION

DISPLAYED TEMPERATURES ARE HEATER TEMPERATURES AND DO NOT INDICATE ACTUAL FOOD TEMPERATURES.

- 5** Press and release the PRINCE CASTLE LOGO button to exit the program mode and return to the RUN MODE.

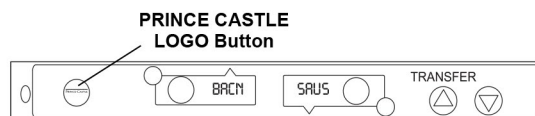

Calibrating Heaters — Measuring and Adjusting Temperatures

1 *NOTE: Allow 30 minutes for heater temperatures to stabilize before starting calibration.*

To view the actual temperature:

- Press and hold the PRINCE CASTLE LOGO button then immediately press and hold the UP arrow button.
- Using a stand-alone temperature meter (not supplied), take a temperature reading within the shelf near the center of the heater surface.
- If the actual temperature does not closely match the temperature on the meter adjustments, proceed to step 2.

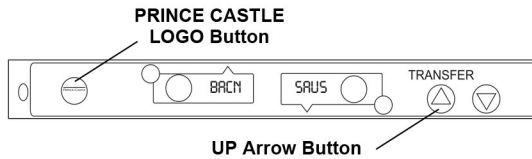

2 Press and hold the PRINCE CASTLE LOGO button, then immediately press and hold the MENU/ENTER button until the display shows one of the nine programming menus.

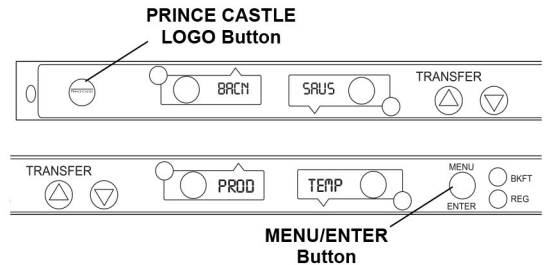

3 Use the UP or DOWN arrow button to scroll to the CAL HTRS menu.



4 Press and release the MENU/ENTER button. The display will show SEL A 1.

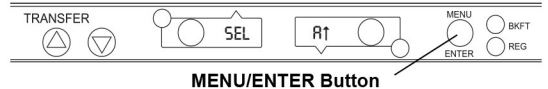

5 Use the UP or DOWN arrow button to scroll to the correct heater. The display will cycle through heaters A, B, C and D. Upper and lower.

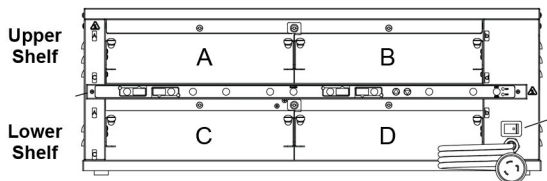

6 Press and release the MENU/ENTER button. The display will show CAL A 1 (if A 1 was chosen) and the actual temperature. The temperature may fluctuate since it is the actual temperature reading.

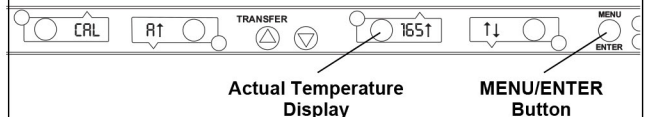

7 Press and release the UP or DOWN arrow button to increase or decrease the displayed temperature.

NOTE: The temperature can be increased or decreased by up to 20°.

The display may not change instantly.

The temperature displayed may fluctuate since it is an actual temperature reading.

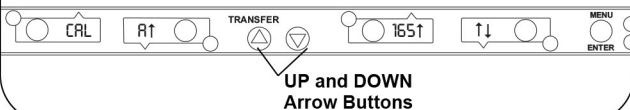

8 Press and release the MENU/ENTER button. The display will go back to CAL HTRS.

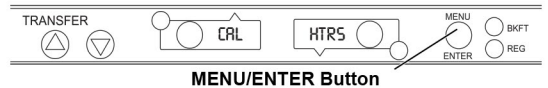

9 Repeat this process for other heaters if needed.

10 When completed press and release the PRINCE CASTLE LOGO button to exit the program mode and return to the run mode.

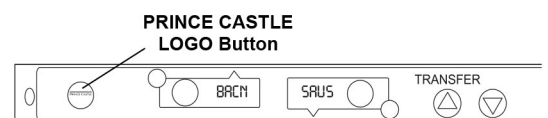

Programming the Menus

- 1** Press and hold the PRINCE CASTLE LOGO button (on the button bar) until all the displays show PROG and the PAN buttons LEDs all glow RED.



- 2** Press and hold the MENU/ENTER button. The display next to the MENU/ENTER button will show the menu choices. Use the UP or DOWN Arrow button to scroll through the 6 menus. Release the MENU/ENTER button when the desired menu is displayed.

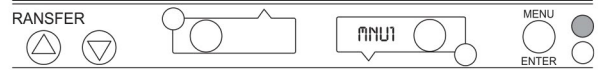

When the MENU/ENTER button is released, all displays will again show PROG.



- 3** A. Press the PAN button next to the display to be changed. The LED will change from RED to YELLOW and the display will change from PROG to the assigned product choice.

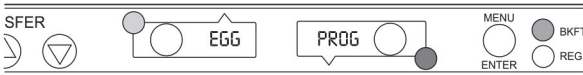

- B. Press the UP or DOWN Arrow button to scroll to the desired product choice.
 C. Press the MENU/ENTER button to save the selection. All displays will show PROG.



- 4** A. Repeat Steps 2 and 3 as required.
 B. Press the PRINCE CASTLE LOGO button to exit the Program Mode and return to the Run Mode.

NOTE: Up to six items (one for each menu) may be programmed for each PAN button. A pan may be set as "not used" by assigning "----" as its product.



DHB2PT-33KFCCD Pan Cover

1. To install or remove the pan cover, move the amber pan simply by raising up the latch and sliding the pan cover in or out.

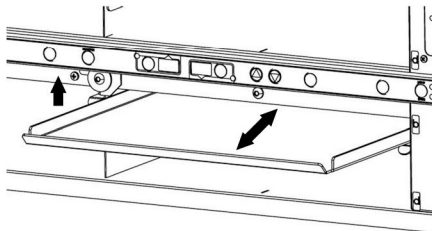

2. When properly installed, the pan cover should have the edges facing up so the smooth side of the cover rests on top of the amber pan.

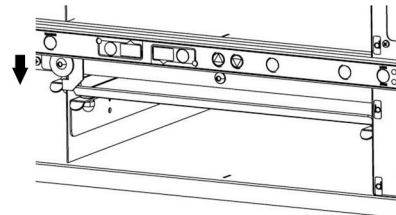

Changing the Hold and Cook-More Times

- 1 A. The SET PRODUCT TIME menu is used to change the Hold and Cook-More times.
- B. Press and hold the PRINCE CASTLE LOGO button, then immediately press and hold the MENU/ENTER button until the display shows one of the programming menus.
- C. Use the UP or DOWN Arrow button to scroll to the PROD TIME menu.

PRINCE CASTLE LOGO Button

MENU/ENTER Button

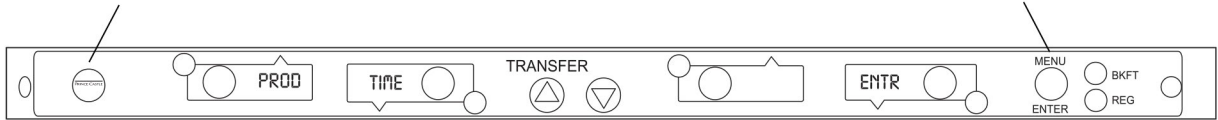

- 2 A. Press and release the MENU/ENTER button to enter the Set Product Time menu. The display will show, for example, EGGS.
- B. Use the UP or DOWN Arrow button to scroll through the list of products. When the desired product is displayed, press the MENU/ENTER button to select it.

Refer to the Product Menu Details on page 13 for a list of products and their corresponding display names.



NOTE: Holding the UP or DOWN Arrow button for longer than 2 seconds will cause the product list to automatically scroll up or down.

- 3 A. The display now shows the current Hold time.



- B. Use the UP or DOWN Arrow button to scroll to the desired Hold time. When the desired Hold time is displayed, press the MENU/ENTER button to save the desired Hold time.



NOTE: Hold time cannot be reduced to less than the Cook-More time plus one minute.

- 4 A. The display will now show current Cook-More time. Use the UP or DOWN Arrow button to scroll to the desired Cook-More time.



- B. When the desired Cook-More time is displayed, press the MENU/ENTER button to save it.



NOTE: Cook-More time cannot be increased to more than the Hold time minus one minute.

- 5 A. The display will show PROD TIME. Repeat Steps 2 – 4 for any other product.
- B. Press and release the PRINCE CASTLE LOGO button at any time to exit the Program Mode and return to the Run Mode.

NOTE: If the MENU/ENTER button has not been pressed to save any changes, the program will revert to the original values.



Setting the Alternating Display Interval

- A. The Alternating Display Interval allows the timer bar displays to alternate between the product name and remaining Hold time. The default setting is 5 seconds.
- B. Press and hold the PRINCE CASTLE LOGO button, then immediately press and hold the MENU/ENTER button until the display shows one of the programming menus.
- C. Use the UP or DOWN Arrow button to scroll to the ALT TIME menu. Press MENU/ENTER button.
- D. Use the UP and DOWN Arrow buttons to adjust the interval setting from 0 to 15 seconds. Press MENU/ENTER to save the change.

NOTE: Setting the interval to 0 seconds will disable display alternation. The display will only show the product name while timing.

- E. Press and hold the PRINCE CASTLE LOGO button at any time to exit the Program Mode.

PRINCE CASTLE LOGO Button

MENU/ENTER Button



Changing Product Names

- 1 A. The EDIT PRODUCT NAME menu is used to change a default product name to one of your own choosing.
 - B. Press and hold the PRINCE CASTLE LOGO button, then immediately press and hold the MENU/ENTER button until the display shows one of four programming menus.
 - C. Use the UP or DOWN Arrow button to scroll to the PROD NAME menu.
- NOTE: The default names available for editing are listed on page 13.*

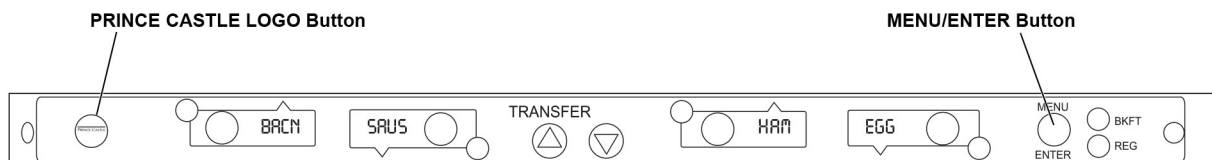

- 2 A. Press and release the MENU/ENTER button to enter the Edit Product Name menu. For example, the display will read PROD SPC1 ENTR.
- B. Use the UP or DOWN Arrow button to scroll through the list of products.
- C. When the desired product is displayed, press the MENU/ENTER button to select it. The first letter (in this case, the E) will start blinking.



- 3 A. To change the blinking E, use the UP or DOWN Arrow button to scroll to the desired letter/number/symbol.
- B. When the desired selection is displayed, press the PAN button (to the left or right of the selected display) to move to the next digit.
- C. Repeat for all digits.



NOTE: Holding the UP or DOWN Arrow button for longer than 2 seconds will cause the selected digit to automatically scroll up or down.

- 4 When all four digits have been changed, press the MENU/ENTER button to save the new name.



- 5 A. The display will show PROD NAME. Repeat Steps 2 – 4 for any other product.
 - B. Press and release the PRINCE CASTLE LOGO button at any time to exit the Program Mode and return to the Run Mode.
- NOTE: If the MENU/ENTER button has not been pressed to save any changes, the program will revert to the original names.*



Addendum: Audio

Audio Capabilities

1. When a PAN button is pressed to activate a timer, the unit will sound a tone.
2. When the timer reaches the "Cook-More" time, an alarm will sound for 5 seconds.
3. When the timer has counted down completely, an alarm will sound continuously until it is manually shut off by pressing the appropriate pan button. The product in that pan should be discarded at this time.

Set Maximum Transfer Time

- 1
 - A. The SET MAXIMUM TRANSFER TIME menu is used to set the amount of time allowed to make a product transfer from one pan to another.
 - B. Press and hold the PRINCE CASTLE LOGO button, then immediately press and hold the MENU/ENTER button until the display shows one of the programming menus.
 - C. Use the UP or DOWN Arrow button to scroll to the XFR TIME menu. (*NOTE: Units with 6 or 8 pan displays will show MAX XFR TIME ↑ ↓ ENTR.*)

PRINCE CASTLE LOGO Button

MENU/ENTER Button



- 2
 - A. Press and release the MENU/ENTER button to enter the Set Maximum Transfer Time menu. The default time is 45 seconds.
 - B. For example, the displays show XFR :20. This shows a value of 20 seconds.



- 3
 - A. To change the time, use the UP or DOWN Arrow button to scroll to the desired time. When the desired selection is displayed, press the MENU/ENTER button to enter the selection.
 - B. Press and release the PRINCE CASTLE LOGO button at any time to exit the Program Mode and return to the Run Mode.

NOTE: If the MENU/ENTER button has not been pressed to save any changes, the program will revert to the original time.

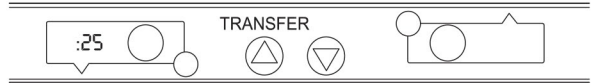

Set Volume Level

- 1
 - A. The default setting for the volume level is 3.
 - B. Press and hold the PRINCE CASTLE LOGO button, then immediately press and hold the MENU/ENTER button until the display shows one of the programming menus.
 - C. Use the UP or DOWN Arrow button to scroll to the Set Vol 3 ↑ ↓ ENTR menu.

PRINCE CASTLE LOGO Button

MENU/ENTER Button



- 2
 - A. Press and release the MENU/ENTER button to enter the Set Volume menu.
 - B. The display shows SET VOL 3 ↑ ↓ ENTR. The number "3" will be flashing. This shows that the volume is currently at level 3. The volume may be set for Vol 0 (off) or for volume levels Vol 1 through Vol 3.

- 3
 - A. To change the volume level, use the UP or DOWN Arrow button to scroll to the desired level. When the desired selection is displayed, press the MENU/ENTER button.
 - B. Press and release the PRINCE CASTLE LOGO button at any time to exit the Program Mode and return to the Run Mode.

NOTE: If the MENU/ENTER button has not been pressed to save any changes, the program will revert to the original volume level.

Changing Temperature Scale

- 1** *NOTE: Temperatures can be displayed in either Fahrenheit or Celsius.*
- A. Press and hold the PRINCE CASTLE LOGO button, then immediately press and hold the MENU/ENTER button until the display shows one of nine programming menus.
- NOTE: All channels must be in an idle state to get into the program mode.*
- B. Use the Up or Down arrow button to scroll to the TEMP F/C menu.

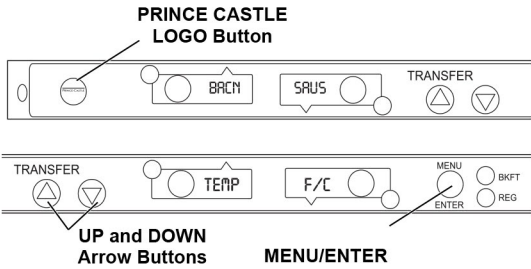

- 2** A. Press and release the MENU/ENTER button to change the temperature scale.
- B. The F or C will begin flashing to indicate the currently selected scale, F (Fahrenheit) or C (Celsius).

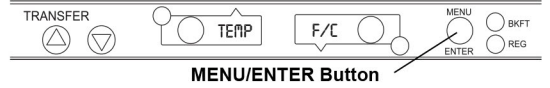

- 3** Use the UP or DOWN arrow to change the selected scale. The flashing F or C indicates the scale that will be selected.

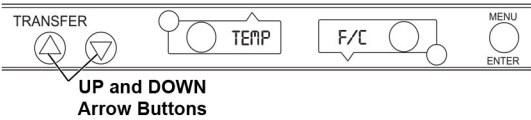

- 4** A. Press and release the MENU/ENTER button to save the changes. The display will stop flashing.

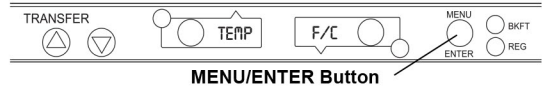

- B. Press and release the PRINCE CASTLE LOGO button to exit the program mode and return to the run mode.

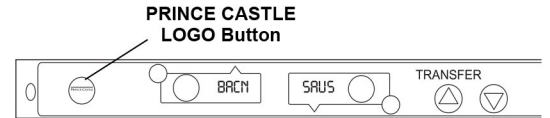

Default Menu

<u>Number</u>	<u>Product</u>	<u>Overhead Heat Setpoint</u>	<u>Base Heat Setpoint</u>	<u>Hold Time</u>
1	Hot Wings	225°	195°	90
2	Freezer to Fryer Filet	190°	195°	60
3	Popcorn Chicken	250°	195°	60
4	Crispy Strips	250°	195°	60

Packline Flow (Drive-Thru Side)

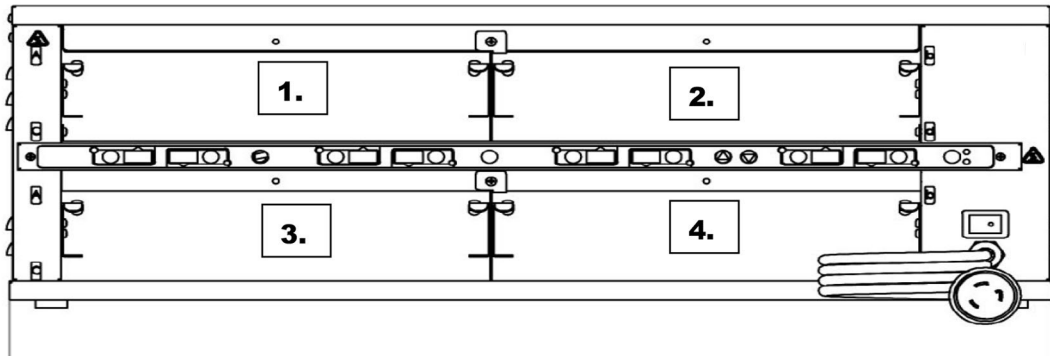

Boot Loader

Procedure for Upgrading Display-less PHU Using Timer Bars – 9640-92-203, 9640-89-137, 138

1. For a first time install, since this is a “no display” system, all of the HEX files for all the various modules have to be programmed using a Microchip programming tool for the first time. Skip the remaining steps if this is a first time install.
2. If this is an upgrade of a pre-existing no display system, place flash stick with files unzipped from Upgrade ZIP file in root folder into the flash drive port. The files DHBFWBIN.TXT, MAINBIN.HEX, DHBFWBAR.TXT, MAINBAR.HEX, and AUXBAR.HEX should be in the root folder of the flash stick.
3. Turn on power to the system and IMMEDIATELY press-and-hold the buttons LOGO, UP, and DOWN on the FRONT FACING timer bar.
4. When the message WAIT appears on the timer bar you can stop pressing these buttons.
5. Wait for the over line dashes to appear “----” on the timer bars. If they do not appear after 1-2 minutes, then the bootload process did not work, repeat from step 1.
6. After the over line dashes disappear from the timer bars, they may reappear 2 or 3 more times during the normal bootload process. If they only appeared once, then the timer bar software was not updated and is already up-to-date.
7. When the products appear on the timer bars, the bootload process is done. Press the down arrow key on the front to verify the correct model and version is loaded on the timer bar and the logo key on the back to confirm the correct model and version is loaded on the back timer bar.

Exploded View and Parts List

ITEM NO.	PART NUMBER	DESCRIPTION
1	541-1372 S	PCB, CONTROL BOARD
2	510-213 S	BB,8AUX 89-138 V2.00
3	510-212 S	BB,8MAIN 89-137 V2.00
4	540-485 S	HEATER INSERT ASSY
5	540-1046 S	UPPER HEATER ASSY
6	540-467 S	HEATER LOWER ASSY
7	78-184 S	POWER SWITCH

ITEM NO.	PART NUMBER	DESCRIPTION
8	197-232 S	FOOT, MOUNTING (4 PACK)
9	540-797 S	GUIDE, UPPER ADJ.
10	540-822 S	DIVIDER ASSY
11	88-709-2-11 S	SPEAKER
12	72-428 S	POWERCORD
13	95-1819 S	USB CORD

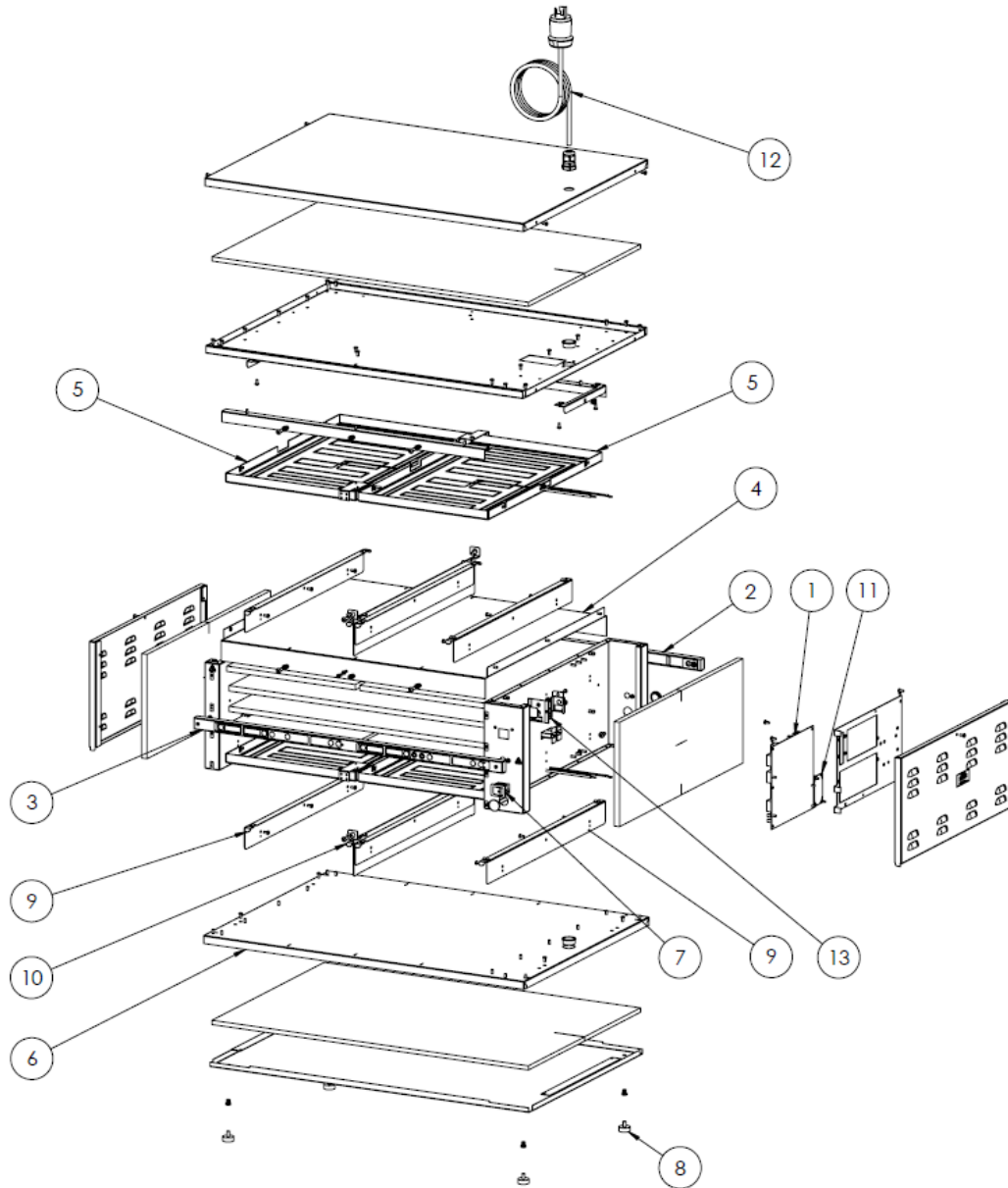

PRINCECASTLE™

MARMON FOODSERVICE TECHNOLOGIES
A BERKSHIRE HATHAWAY COMPANY

355 East Kehoe Blvd. • Carol Stream, IL 60188 USA
Telephone 630-462-8800 • Fax: 630-462-1460
Toll Free: 1-800-PCASTLE
www.princecastle.com