

OPERATING INSTRUCTIONS

PRINCE CASTLE INC. 
WORLDWIDE

Model 454-B Dual Chamber Toaster

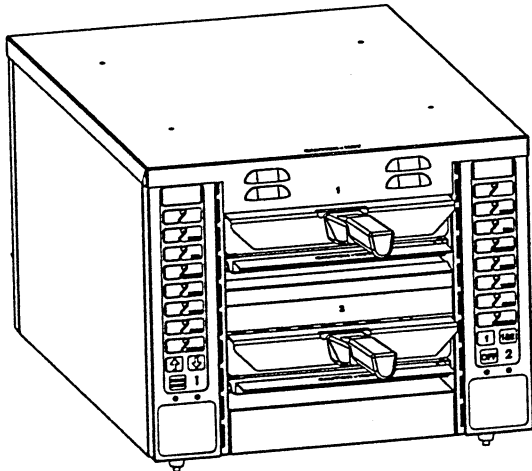

Specifications:

208-240V
60 Hz
1 Phase
5200W

TABLE OF CONTENTS	PAGE
Installation	2
Operation	2
Programming	3
Cleaning	3
Troubleshooting	4

LIMITED WARRANTY

This toaster is warranted to be free from defects in material and/or workmanship for a period of (1) Year from date of original installation or (18) months from date of shipment from factory. Any part or component which proves to be faulty will be replaced or repaired without cost to the customer for parts or labor. (At the option of Prince Castle Inc.)

This warranty is subject to the following exceptions/conditions:

Any use of **Non-Genuine Prince Castle Parts** voids this warranty.

This toaster is **portable**; charges for on location service (e.g., trip charges, mileage) are only included in the first 30 days of this warranty.

All labor shall be performed during regular work hours. Overtime premium may be charged to the buyer.

Damage caused by carelessness, neglect, and/or abuse (e.g., using wrong current, dropping, tampering with or altering electrical components, or improper cleaning) voids this warranty.

All problems due to operation at voltages other than specified on toaster nameplates.

Equipment damaged in shipment, by fire, flood or an act of God.

This product must be serviced by a Prince Castle Authorized Service Center or a Prince Castle Factory Service Technician. Failure to do so can void this warranty.

PRINCE CASTLE INC. 
WORLDWIDE

355 East Kehoe Blvd. • Carol Stream, IL 60188
Tel: (630) 462-8800 • Fax: (630) 462-1460
Toll Free: 1-800-PCASTLE

INSTALLATION

IMPORTANT: A SPECIAL PACKING FOAM IS PROVIDED BETWEEN THE HEATING ELEMENTS AND THE PROTECTIVE WIRE. BE SURE TO REMOVE THIS FOAM PRIOR TO OPERATING TOASTER.

1. Position the Bun Toaster in a well ventilated area.
2. Unwrap crumb tray and bun spatula. Install crumb tray on toaster by sliding it into the brackets located on both sides of the heating compartments.

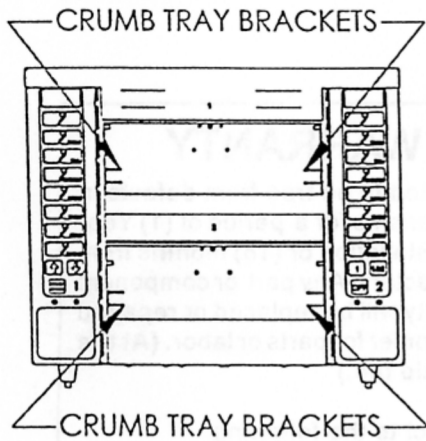

3. Wash, rinse, and sanitize spatula prior to use.
NOTE: When using spatula to toast products, slide it in above the crumb tray. When not toasting, slide underneath the crumb tray.

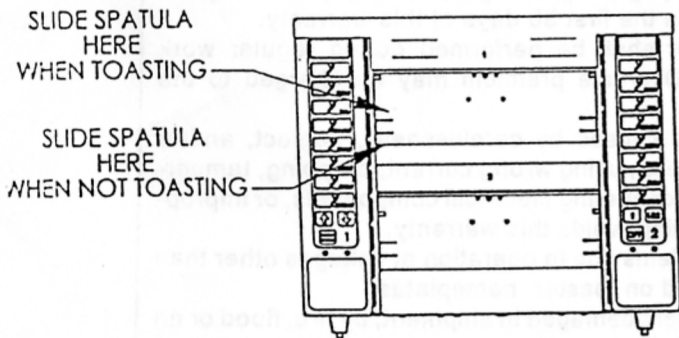

IMPORTANT: Clean air filters daily and **DO NOT** block air filter at **FRONT** of cabinet, as this may cause toaster to overheat and damage components voiding the warranty.

4. Insert the 3 pin Power Cord plug into a 208 VAC 60HZ 5850 Watts Single Phase circuit. Once inserted twist plug to the right, lock into position.

5. To Turn the Power "ON". Press 1 & 2 if you want to use both sides of the toaster. Press 1 if you want to use one side only. The left display will read **CLN** & the right display will read **FLT**. This stands for *clean filter* to remind you to keep your filters clean.
6. Toaster requires approximately 2 minutes warm up and the displays will read **RDY** indicating the toaster is ready for use.

OPERATION

The following toasting times were pre-set at the factory prior to shipment. Adjustments may be necessary due to variable cut or moisture content of the product, see **PROGRAMMING** section if necessary.

NOTE: Display is in minutes and seconds.

Toaster Button Description	Toast Time
Blank	
Bread	:55
Roll	:55
Crescent	:30
Muffin	:20
Wheat	:50
Jumbo	:50
Regular	:45

2. Load spatula into the toasting chamber.
3. To start a toasting cycle press the button. The display will light up and begin counting down.

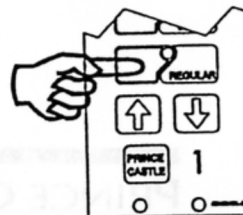

Note: To cancel an activated channel, press that channel once and it will stop counting down.

4. When the countdown sequence has finished an audio alarm will sound and the display will read **END**. The audio alarm will automatically stop after 5 seconds or you can manually cancel by pressing the product button.

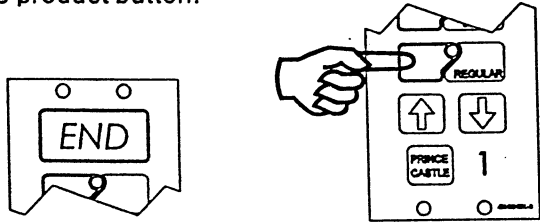

4. When you have set the desired toast time press the **PRODUCT BUTTON** again. The display will go blank for a second, then it will display **888** and then **RDY**. To adjust the time on the other product buttons repeat steps 1-3.

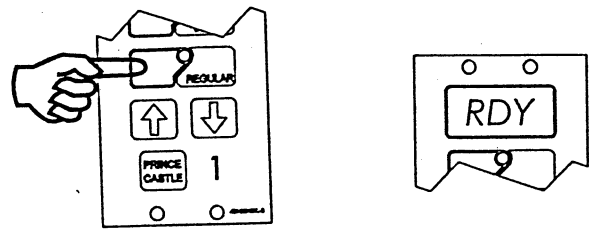



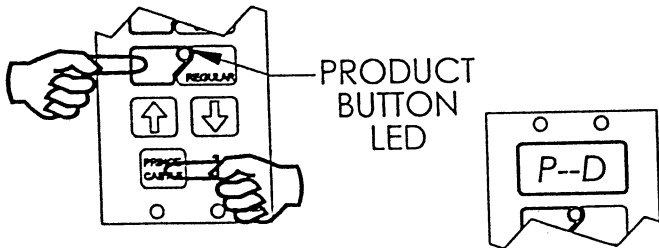

PROGRAMMING



1. Press and hold the **PRINCE CASTLE** and the **PRODUCT BUTTON** that you want to change for 6 seconds, the display will read **P--D** and the **PRODUCT BUTTON LED** will light up.





VOLUME ADJUSTMENT

The audio alarm can be adjusted to two settings **"HIGH"** and **"LOW"**.

1. To choose the **"HIGH"** setting press & hold  
2. To choose the **"LOW"** setting press & hold  

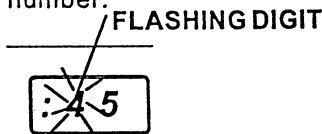
2. The left digit will flash. Press the  to change the flashing digit to a higher number. Press  to change to a lower number.



3. Press the  to move to the next digit. Repeat step 2 to change the other digits.

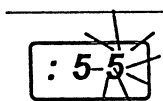

FLASHING DIGIT

CLEANING

1. Before cleaning the toaster press the **"OFF"** button on the right display to turn the toaster off. **NOTE: After turning the power off the fans will continue to run for about (7) minutes to help cool down the heaters. Unplug from the outlet and allow 20 minutes to cool down.**

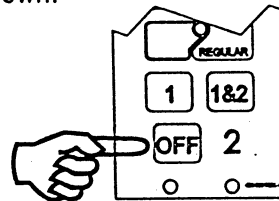

2. Wipe toaster with a clean damp cloth. **DO NOT** use any chemical cleaners on the front overlays.

IMPORTANT: Do not get water on the **HEATERS**. This could cause serious electrical damage to the toaster.

IMPORTANT: Clean air filter daily by soaking them in warm soapy water, rinse and let air dry.

TROUBLESHOOTING

Diagnostic Error Codes

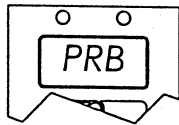
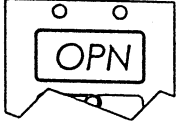

OPN / PRB = Open Probe

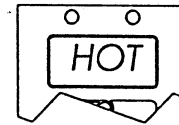
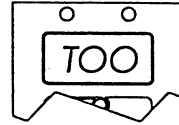

Too / Hot = Control Box Too Hot

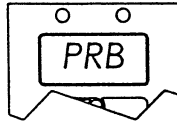

SHR / PRB = Shorted Probe

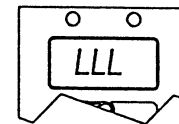
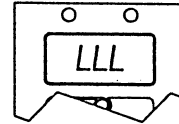

LLL = Low Heat

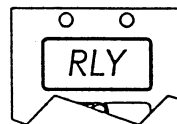
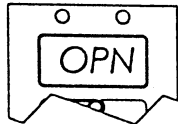

OPN / RLY = Open Relay

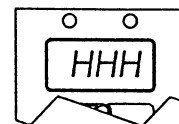
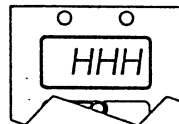

HHH = Toasting Chamber Too High

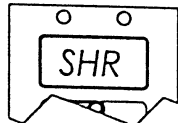

SHR / RLY = Shorted Relay

IF THERE IS A FAILURE ON THE BOTTOM HEATER THE TOASTER CAN STILL BE OPERATED ON THE TOP ONLY. IF THERE IS A FAILURE ON THE TOP HEATER THE TOASTER CANNOT BE USED.

PROBLEM	CAUSE	SOLUTION
1. Display reads SHR / REL OPN / REL SHR / PRB OPN / PRB	1. Shorted Relay. 2. Open Relay. 3. Shorted Probe. 4. Open Probe.	1. Turn toaster off and call your authorized Prince Castle Service Agent to arrange repair.
2. Display Reads HHH or Too Hot.	1. Dirty Air Filter. 2. Heater Temperature or control box temperature too high	1. Clean Air Filter. 2. Turn toaster off and call your authorized Prince Castle Service Agent to arrange repair.
3. Product too light or too dark	1. Toast Time Incorrect.	1. Adjust toast times .
4. Product button does not activate countdown sequence.	1. Inoperable operate switch.	1. Turn toaster off and call your authorized Prince Castle Service Agent to arrange repair.
5. Toaster will not turn on.	1. Unit Unplugged. 2. Circuit Breaker off. 3. Inoperable Power Switch. 4. Open Power Cord 5. Open Ribbon Cable	1. Plug Unit In. 2. Switch Circuit Breaker On. 3. Contact your Authorized Prince Castle Service Agent To Arrange Repair

454-B DUAL CHAMBER TOASTER

ITEM NO.	QTY.	PART NO.	DESCRIPTION
1	1	454-015	UPRIGHT, RH
2	1	454-002	COVER, TOP ASSY
3	2	454-006	COVER, SIDE
4	1	454-014	UPRIGHT, LH
5	2	424-087	HEATING ELEMENT
6	2	424-079	SPATULA
7	2	424-149	CRUMB TRAY
8	2	454-037	FAN, 4" TUBEAXIAL W/TAPPED HLS
9	2	454-009	SUPPORT, ASSY
10	1	454-003	COVER, REAR
11	2	065-058	RELAY,SS,50A,280VAC,3-32VDC
12	1	085-060	TRANSFORMER
13	2	424-170	THERMOSTAT
14	1	454-018	OVERLAY, PANEL ASSY LH
15	1	454-019	OVERLAY, PANEL ASSY RH
16	1	072-190	POWER CORD ASSY
17	2	454-020	FILTER
18	1	088-514	SPEAKER, 8 OHM, 0.5 WATT
19	2	077-059	TERMINAL BLOCK
20	2	424-056	PROBE
21	16	454-021	ROD, GRATE
22	1	424-158	BRACKET, PCB MTG.
23	6	089-924	STANDOFF, #6-32 X .375
24	1	424-175	PCB ASSY,MAIN,HI TEMP,RLY DRV

