

UHX2462
INDOOR UNIT

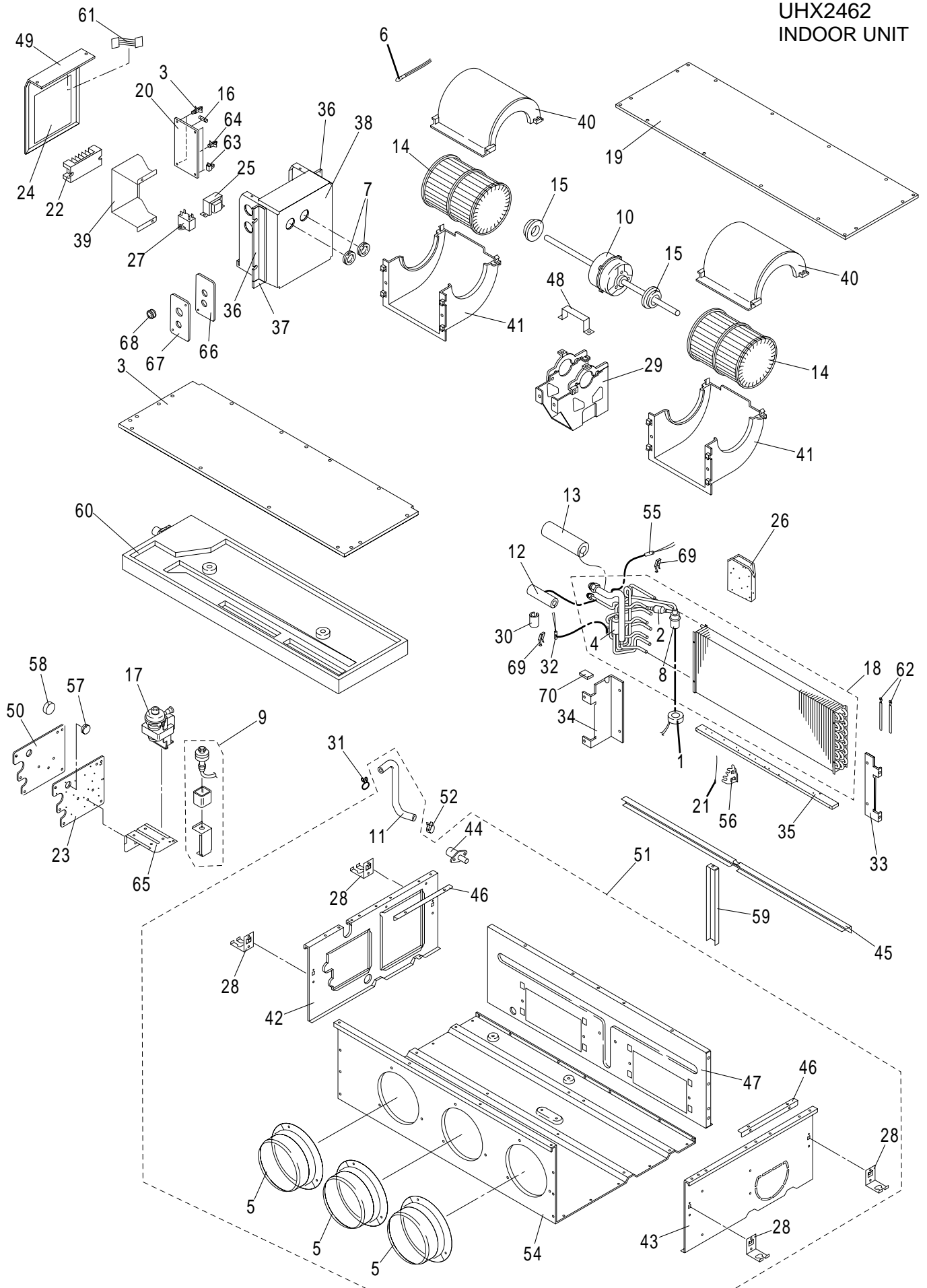

ATTENTION !

To ensure correct parts supply, please let us know followings,
when you make service parts order:

1.Part No. 2.Description 3.Q'ty 4.Volts-Hz-Ph 5.Product Model No.

UHX2462
INDOOR UNIT

KeyNo.	Part No.	Description	Q'ty	Reference No.
* 1	623 176 0508	Magnetic Coil(PMV) UKV-U031E	1	1FA-4-L8A0-31100
2	623 101 8968	Strainer Ass'y	1	854-0-4522-13100
3	623 096 5966	Spacer SPLSN-4	2	851-2-5366-03700
4	623 176 1550	Strainer Ass'y	1	854-0-4522-28600
5	623 192 1404	Angle flange Ass'y	3	854-2-2306-262H2
* 6	623 311 8086	Thermistor Ass'y(TA) KTEC-35-S85	1	8FA-0-5259-48300
7	623 000 0735	Eyelet	2	3-9041-01500
* 8	623 175 2336	Solenoid Control Valve UKV-25D32	1	854-2-4548-20300
* 9	623 311 8109	Switch Ass'y	1	8FA-0-5152-06100
* 10	623 311 8192	Fan Motor Ass'y KFC4X-71C6P	1	8FA-0-5202-08300
11	623 182 4729	Drain Hose	1	854-2-4297-20700
12	623 160 1344	Insulation Special	1	854-2-2411-22210
13	623 160 1320	Insulation Special	1	854-2-2411-22310
* 14	623 160 5380	Centrifugal Fan Ass'y	2	854-0-2501-22830
15	638 015 1486	Cushion Rubber	2	854-2-2534-17500
16	423 033 1606	Fuse ET 5A	1	F31S5R0A2SCTR
* 17	623 311 8147	Motor Pump Ass'y ZPLD-12230ST-XH-	1	8FA-0-5264-09300
* 18	623 176 4759	Heat Exch Ass'y	1	854-0-4124-36400
19	623 159 5278	Top Cover	1	854-2-1106-38000
* 20	623 311 8130	Controller Ass'y CR-UHX0762	1	854-9-9536-05710
* 21	623 311 8123	Thermistor Ass'y(BL) KTEC-35-S85	1	8FA-0-5259-47000
* 22	623 303 8087	Terminal Base HP-T3052-1-6P	1	1FA-4-J3A0-34500
23	623 159 4943	Insulation	1	854-2-1408-77600
24	623 311 8116	Elec. Wiring Diagram	1	8FA-2-5250-67800
* 25	623 201 1517	Transformer Ass'y ATR-IL224B-T-R	1	8FA-0-5263-06100
26	638 020 7220	Vibration Insulation	1	854-2-2475-17200
* 27	623 311 8215	Fixed Capacitor CMPS UP44B455JMF	1	1FA-4-C1A0-15700
28	638 018 7188	Hook Plate	4	854-2-1130-24201
29	638 018 7621	Support Motor Ass'y	1	854-0-2511-24801
30	623 054 6073	Insulation Tube	1	852-2-4514-28600
31	623 171 4778	Clip	1	854-2-2315-10700
* 32	623 311 8154	Thermistor Ass'y(E1) PB2M-41E-S15-2	1	8FA-0-5259-46800
33	623 182 4774	Mounting Plate, Evaporator	1	854-2-2303-31311
34	623 182 4781	Mounting Plate, Evaporator	1	854-2-2303-31611
35	623 160 5397	Insulation, Evaporator	1	854-2-2404-30910
36	638 018 7409	Mounting Plate	2	854-2-5309-14200
37	638 018 7416	Mounting Plate	1	854-2-5309-14300
38	623 160 1443	Elec Component Box	1	854-2-5306-15900
39	623 311 7591	Support Terminal	1	854-2-5316-23701
40	623 160 1474	Blower Casing	2	854-2-2506-19310

NOTE: Metal and plastic parts will be supplied basically
with necessary heat insulation pads or packing.
Each key number with an asterisk (*) means the
recommended service parts.

ATTENTION !

To ensure correct parts supply, please let us know followings,
when you make service parts order:

1.Part No. 2.Description 3.Q'ty 4.Volts-Hz-Ph 5.Product Model No.

UHX2462
INDOOR UNIT

KeyNo.	Part No.	Description	Q'ty	Reference No.
41	623 160 1450	Blower Casing	2	854-2-2506-19210
42	638 018 7102	Side Panel Ass'y	1	854-0-1102-39200
43	638 018 7614	Side Panel Ass'y	1	854-0-1102-39300
44	623 160 1481	Joint Drain	1	854-2-2334-18610
45	638 018 7843	Mounting Panel	1	854-2-1127-19000
46	638 018 7171	Mounting Plate	2	854-2-1129-95100
47	638 018 7805	Plate Partition Blower	1	854-2-2505-19100
48	638 018 7683	Support Fan Motor	1	854-2-2516-30000
49	638 018 7386	Cover,Elec.Component Box	1	854-2-5304-50300
50	623 176 0560	Cover Plate	1	854-2-2307-22000
51	623 201 1548	Cabinet Plate Ass'y	1	854-2-1105-290H5
52	623 171 4839	Clip	1	854-2-2315-10801
53	623 174 3372	Cover Plate Ass'y	1	854-2-2343-163H1
54	623 159 5223	Cabinet Plate	1	854-2-1105-29000
* 55	623 311 8161	Thermistor Ass'y(E3) PB2M-41E-S14-2	1	8FA-0-5259-46900
56	638 012 1915	Mounting Thermistor	1	826-2-5303-11100
57	623 015 3431	Plug	1	733-2-3313-12000
58	638 020 1150	Insulation	1	854-2-1408-77700
59	638 018 7263	Mounting Plate	1	854-2-2361-49800
* 60	623 311 8222	Drain Pan Ass'y	1	854-0-2301-679H2
61	623 120 9908	Wire Ass'y	1	851-0-5292-70200
62	628 012 9219	Fixture Cord	2	731-2-5323-12000
63	623 038 3333	Spacer	2	851-2-5366-01200
64	623 096 5973	Spacer SPSN-4	1	851-2-5366-04100
65	623 201 1531	Mounting Plate	1	854-2-2362-12401
66	623 160 1528	Mounting Plate	1	854-2-5309-18301
67	623 192 1527	Insulation	1	854-2-1408-85100
68	623 038 3425	Bushing OCB-875	1	851-2-5370-00900
69	623 148 5876	Mounting Thermostat	2	852-2-5303-22401
70	623 311 6839	Packing	1	854-2-2370-26110
	623 311 7140	Operation Manual	1	854-6-4609-01800

NOTE: Metal and plastic parts will be supplied basically with necessary heat insulation pads or packing. Each key number with an asterisk (*) means the recommended service parts.

For Parts or Service Assistance please contact your local Sanyo HVAC Contractor or Distributor

United States: SCS, HVAC Solutions

Web: www.SanyoHVAC.com

Parts: hvac.parts@sna.sanyo.com

Service: hvac.service@sna.sanyo.com

Canada: Sanyo Canada Inc.

Web: www.SanyoHVAC.com

Parts/Service: hvac@sci.sanyo.com

Nov / '09 Printed in U.S.A